

## FCC Compliance Statement:

<p style="text-align: center;"><b>DECLARATION OF CONFORMITY</b> Per FCC Part 2 Section 2.107(a)</p> <p style="text-align: center;"><b>FC</b></p> <p>Responsible Party Name: G.B.T. INC.</p> <p style="text-align: center;">Address: 18365 Valley Blvd., Suite#A LA Puente, CA 91744</p> <p style="text-align: center;">Phone/Fax No: (818) 854-9338 / (818) 854-9339</p> <p>hereby declares that the product</p> <p style="text-align: center;">Product Name: Mother Board</p> <p style="text-align: center;">Model Number: GA-6VXD7</p> <p>Conforms to the following specifications:</p> <p style="text-align: center;">FCC Part 15, Subpart B, Section 15.107(a) and Section 15.109(a), Class B Digital Device.</p> <p><b>Supplementary Information:</b></p> <p style="text-align: center;"><small>This device complies with part 15 of the FCC Rules. Operation is subject to the following two conditions: (1) This device may not cause harmful and (2) this device must accept any interference received, including that may cause undesired operation.</small></p> <p>Representative Person's Name: <u>ERIC LI</u></p> <p>Signature: <u>Eric Li</u></p> <p>Date: <u>Jul. 20, 2000</u></p>
--

This equipment has been tested and found to comply with limits for a Class B digital device, pursuant to Part 15 of the FCC rules. These limits are designed to provide reasonable protection against harmful interference in residential installations. This equipment generates, uses, and can radiate radio frequency energy, and if not installed and used in accordance with the instructions, may cause harmful interference to radio communications. However, there is no guarantee that interference will not occur in a particular installation. If this equipment does cause interference to radio or television equipment reception, which can be

determined by turning the equipment off and on, the user is encouraged to try to correct the interference by one or more of the following measures:

- Reorient or relocate the receiving antenna
- Move the equipment away from the receiver
- Plug the equipment into an outlet on a circuit different from that to which the receiver is connected
- Consult the dealer or an experienced radio/television technician for additional suggestions

You are cautioned that any change or modifications to the equipment not expressly approve by the party responsible for compliance could void Your authority to operate such equipment.

This device complies with Part 15 of the FCC Rules. Operation is subjected to the following two conditions 1) this device may not cause harmful interference and 2) this device must accept any interference received, including interference that may cause undesired operation.

## Declaration of Conformity

We, Manufacturer/Importer  
(full address)

**G.B.T. Technology Trading GmbH**  
**Ausschlagler Weg 41, 1F, 20537 Hamburg, Germany**

declare that the product  
( description of the apparatus, system, installation to which it refers)

**Mother Board**  
GA-6VXD7

is in conformity with  
(reference to the specification under which conformity is declared)  
in accordance with 89/336 EEC-EMC Directive

- |   |  |  |  |
|---|--|--|--|
| <input type="checkbox"/> EN 55011   | Limits and methods of measurement of radio disturbance characteristics of industrial, scientific and medical (ISM high frequency equipment                 | <input type="checkbox"/> EN 61000-3-2*<br><input checked="" type="checkbox"/> EN60555-2          | Disturbances in supply systems caused by household appliances and similar electrical equipment "Harmonics"   |
| <input type="checkbox"/> EN55013  | Limits and methods of measurement of radio disturbance characteristics of broadcast receivers and associated equipment                                     | <input type="checkbox"/> EN61000-3-3*<br><input checked="" type="checkbox"/> EN60555-3           | Disturbances in supply systems caused by household appliances and similar electrical equipment "Voltage fluctuations"                                  |
| <input type="checkbox"/> EN 55014   | Limits and methods of measurement of radio disturbance characteristics of household electrical appliances, portable tools and similar electrical apparatus | <input checked="" type="checkbox"/> EN 50081-1<br><input checked="" type="checkbox"/> EN 50082-1 | Generic emission standard Part 1: Residual, commercial and light industry<br>Generic immunity standard Part 1: Residual, commercial and light industry |
| <input type="checkbox"/> EN 55015   | Limits and methods of measurement of radio disturbance characteristics of fluorescent lamps and luminaries   | <input type="checkbox"/> EN 55081-2  | Generic emission standard Part 2: Industrial environment   |
| <input type="checkbox"/> EN 55020   | Immunity from radio interference of broadcast receivers and associated equipment   | <input type="checkbox"/> EN 55082-2  | Generic immunity standard Part 2: Industrial environment   |
| <input checked="" type="checkbox"/> EN 55022  | Limits and methods of measurement of radio disturbance characteristics of information technology equipment   | <input type="checkbox"/> ENV 55104   | Immunity requirements for household appliances tools and similar apparatus   |
| <input type="checkbox"/> DIN VDE 0855<br><input type="checkbox"/> part 10<br><input type="checkbox"/> part 12 | Cabled distribution systems; Equipment for receiving and/or distribution from sound and television signals   | <input type="checkbox"/> EN 50091- 2   | EMC requirements for uninterruptible power systems (UPS)   |
| <input checked="" type="checkbox"/> CE marking  |  |               | (EC conformity marking)  |

**The manufacturer also declares the conformity of above mentioned product with the actual required safety standards in accordance with LVD 73/23 EEC**

- |                                   |   |                                     |   |
|-----------------------------------|---|-------------------------------------|---|
| <input type="checkbox"/> EN 60065 | Safety requirements for mains operated electronic and related apparatus for household and similar general use | <input type="checkbox"/> EN 60950   | Safety for information technology equipment including electrical business equipment |
| <input type="checkbox"/> EN 60335 | Safety of household and similar electrical appliances   | <input type="checkbox"/> EN 50091-1 | General and Safety requirements for uninterruptible power systems (UPS)             |

Manufacturer/Importer

Signature : Rex Lin  
Name : Rex Lin

(Stamp)

Date : Jul. 20, 2000

**6VXD7**  
**Dual Socket 370 Server/Workstation**  
**Motherboard**

**USER'S MANUAL**

Dual Socket 370 Server/Workstation Motherboard  
REV. 1.0 Third Edition  
R-10-03-010627  
12ME-6VXD7-1003



## How This Manual Is Organized

This manual is divided into the following sections:

<b>1) Revision History</b>	Manual revision information
<b>2) Item Checklist</b>	Product item list
<b>3) Features</b>	Product information & specification
<b>4) Hardware Setup</b>	Instructions on setting up the motherboard
<b>5) Performance &amp; Block Diagram</b>	Product performance & block diagram
<b>6) Dual BIOS</b>	Dual BIOS
<b>7) Four Speaker &amp; SPDIF</b>	Four Speaker & SPDIF introduction
<b>8) BIOS Setup</b>	Instructions on setting up the BIOS software
<b>9) Appendix</b>	General reference



## Table Of Content

Revision History	P.1
Item Checklist	P.2
Summary of Features	P.3
6VXD7 Motherboard Layout	P.5
Page Index for CPU Speed Setup/Connectors/Panel and Jumper Definition	P.6
Performance List	P.26
Block Diagram	P.28
Dual BIOS Introduction (Optional)	P.29
Four Speaker & SPDIF Introduction (Optional)	P.36
Memory Installation	P.41
Page Index for BIOS Setup	P.42
Appendix	P.71

## Revision History

Revision	Revision Note	Date
1.0	Initial release of the 6VXD7 motherboard user's manual.	Jul.2000
1.0	Second release of the 6VXD7 motherboard user's manual.	Jul.2000
1.0	Third release of the 6VXD7 motherboard user's manual.	Jun.2001

The author assumes no responsibility for any errors or omissions that may appear in this document nor does the author make a commitment to update the information contained herein. Third-party brands and names are the property of their respective owners.

---

## Item Checklist

- The 6VXD7 motherboard
- Cable for IDE / floppy device
- Diskettes or CD (TUCD) for motherboard driver & utility
- 6VXD7 user's manual

## Summary Of Features

Form Factor	<ul style="list-style-type: none"> <li>• 30.5 cm x 24.4 cm ATX size form factor, 6 layers PCB.</li> </ul>
CPU	<ul style="list-style-type: none"> <li>• 2 Socket 370 processor Intel Pentium® III 100/133MHz FSB, FC-PGA</li> <li>• 2<sup>nd</sup> cache in CPU (Depend on CPU)</li> </ul>
Chipset	<ul style="list-style-type: none"> <li>• VT82C694X (VIA Apollo Pro 133A)</li> <li>• VT82C686A</li> </ul>
Clock Generator	<ul style="list-style-type: none"> <li>• ICS 9248AF-63</li> <li>• 100/133 MHz system bus speeds (PCI 33MHz)</li> <li>• 112/124/142/152 MHz system bus speeds (PCI &gt;33MHz) (reserved)</li> </ul>
Memory	<ul style="list-style-type: none"> <li>• 4 168-pin DIMM sockets</li> <li>• Supports PC-100 / PC-133 SDRAM and VCM SDRAM</li> <li>• Supports up to 2GB DRAM (Max)</li> <li>• Supports only 3.3V SDRAM DIMM</li> <li>• Supports 72bit ECC type DRAM integrity mode</li> </ul>
I/O Control	<ul style="list-style-type: none"> <li>• VT82C686A</li> </ul>
Slots	<ul style="list-style-type: none"> <li>• 1 AGP slot supports 2X/4X mode &amp; AGP 2.0 compliant</li> <li>• 5 PCI slot supports 33MHz &amp; PCI 2.2 compliant</li> <li>• 1 16-bit ISA Bus slots (Optional)</li> </ul>
On-Board IDE	<ul style="list-style-type: none"> <li>• Supports PIO mode 3, 4, UDMA33/ATA66 IDE &amp; ATAPI CD-ROM</li> <li>• 2 IDE bus master (UDMA 33/ ATA 66) IDE ports for up to 4 ATAPI devices</li> </ul>
Hardware Monitor	<ul style="list-style-type: none"> <li>• CPU1 / CPU2 Fan revolution detect</li> <li>• CPU1 / CPU2 temperature detect</li> <li>• System voltage detect</li> <li>• CPU overheat shutdown detect</li> </ul>
On-Board Peripherals	<ul style="list-style-type: none"> <li>• 1 floppy port supports 2 FDD with 360K, 720K, 1.2M, 1.44M and 2.88M bytes</li> <li>• 1 parallel ports supports SPP/EPP/ECP mode</li> <li>• 2 serial ports (COM 1 &amp; COM 2)</li> <li>• 4 USB ports</li> <li>• 1 IrDA connector for Fast IrDA</li> </ul>

To be continued...

---

Summary of Features

PS/2 Connector	<ul style="list-style-type: none"><li>• PS/2<sup>®</sup> Keyboard interface and PS/2<sup>®</sup> Mouse interface</li></ul>
BIOS	<ul style="list-style-type: none"><li>• Licensed AMI BIOS, 2M bit flash ROM</li><li>• Support Dual BIOS (Optional)</li></ul>
On-Board Sound	<ul style="list-style-type: none"><li>• Creative CT5880 sound (Optional)</li><li>• AC'97 CODEC</li><li>• Line In / Line Out / Mic In / AUX In / CD In / TEL / Game Port /Four Speaker &amp; SPDIF (Optional)</li></ul>
Additional Features	<ul style="list-style-type: none"><li>• Support Wake-On-LAN (WOL)</li><li>• Support Internal / External Modem Ring On</li><li>• Includes 4 fan power connectors</li><li>• Poly fuse for keyboard over-current protection</li></ul>

# 6VXD7 Motherboard Layout

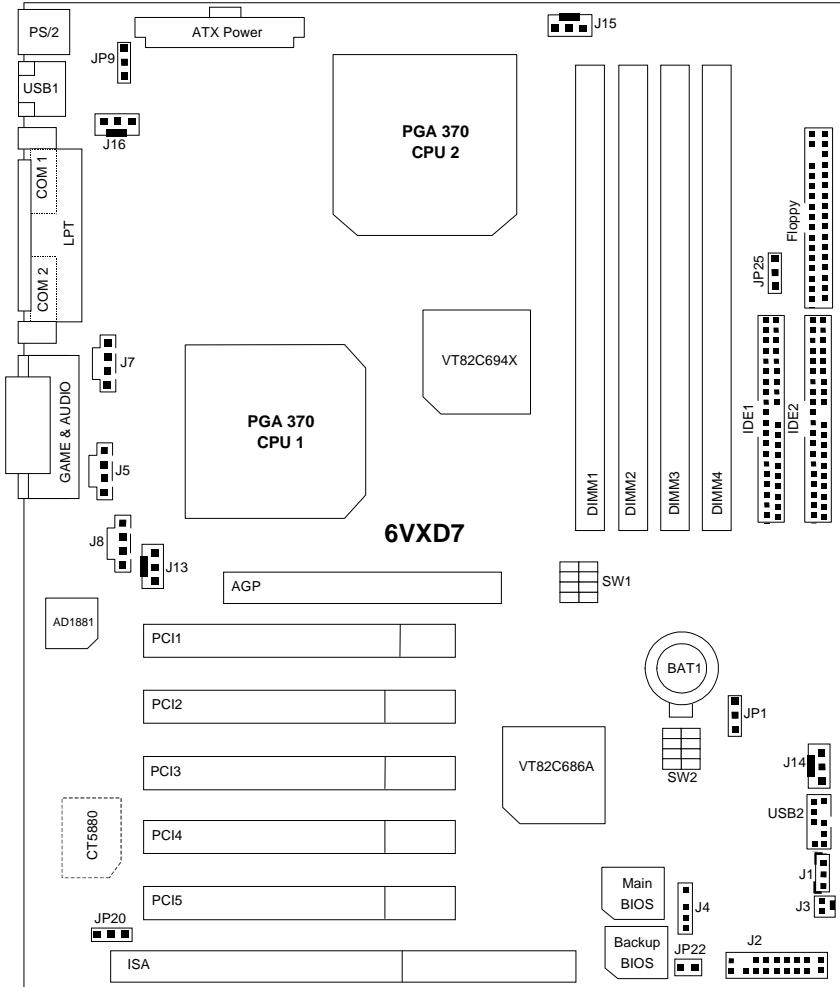

	Page
Page Index for CPU Speed Setup/Connectors/Panel and Jumper Definition	
CPU Speed Setup	P.7
Connectors	P.13
Game & Audio Port	P.13
COM 1 / COM 2 / LPT Port	P.13
USB1 Connector	P.14
PS/2 Keyboard & PS/2 Mouse Connector	P.14
J13 (CPU1 Fan)	P.15
J15 (CPU2 Fan)	P.15
J16 (Power Fan)	P.16
J14 (Panel Fan)	P.16
ATX Power	P.17
Floppy Port	P.17
IDE 1(Primary) / IDE 2(Secondary) Port	P.18
J7 (TEL)	P.18
J5 (AUX_IN)	P.19
J8 (CD Audio Line In)	P.19
J3 (Ring Power On)	P.20
J1 (Wake On LAN)	P.20
J4 (IR)	P.21
USB 2 Connector	P.21
Panel and Jumper Definition	P.22
J2 (2x11 Pins Jumper)	P.22
JP1 (Clear CMOS Function)	P.23
JP22 (BIOS Flash ROM Write Protect) [Optional]	P.23
JP20 (Onboard Sound Function) [Optional]	P.24
JP9 (USB Device Wake Up Selection)	P.24
BAT1 (Battery)	P.25

## CPU Speed Setup

The system bus speed is selectable at 100,133MHz. The user can select the system bus speed (**SW1 & JP25**) and change the DIP switch (**SW2**) selection to set up the CPU speed for 500 – 1GHz + processor.

### Set System Bus Speed

SW1/JP25:

O : ON, X : OFF

1	2	3	4	JP25	CPU (MHz)	PCI (MHz)
X	X	X	X	2-3	100	33
O	X	X	X	1-2	112	37
O	O	X	X	1-2	124	41
O	O	O	X	2-3	133	33
X	O	O	X	N/C	142	35
O	X	O	X	N/C	152	38

The CPU speed must match with the frequency ratio. It will cause system hanging up if the frequency ratio is higher than that of CPU.

SW2:

FREQ. RATIO	DIP SWITCH			
	1	2	3	4
X3	O	X	O	O
X3.5	X	X	O	O
X4	O	O	X	O
X4.5	X	O	X	O
X5	O	X	X	O
X5.5	X	X	X	O
X6	O	O	O	X
X6.5	X	O	O	X
X7	O	X	O	X
X7.5	X	X	O	X
X8	O	O	X	X
X8.5	O	X	O	O
X9	X	X	O	O
X9.5	X	O	O	O
X10	X	O	X	X
X10.5	O	O	X	O
X11	O	X	X	X

X11.5	X	O	X	O
X12	O	X	X	O
X13	X	X	X	O
X14	O	O	O	X
X15	X	O	O	X
X16	O	X	O	X

☛ The same CPU must be used in CPU socket1 and 2. (The same stepping, FSB, ratio)

★Note: We don't recommend you to set up your system speed to 112, 124, 142, 152 MHz because these frequencies are not the standard specifications for CPU, Chipset and most of the peripherals. Whether your system can run under 112, 124, 142, 152 MHz properly will depend on your hardware configurations: CPU, SDRAM, Cards, etc.

### 1. Pentium® !!! 500/100MHz FSB

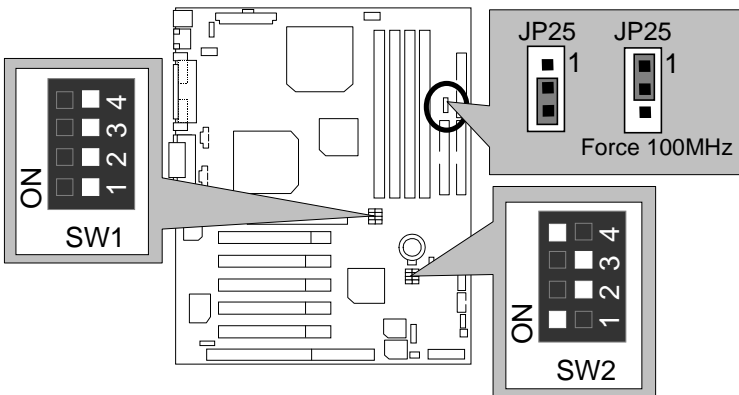

## 2. Pentium® !!! 550/100MHz FSB

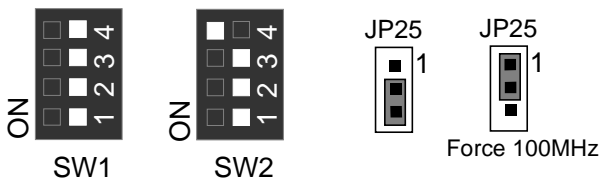

## 3. Pentium® !!! 600/100MHz FSB

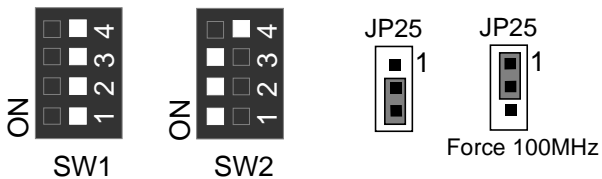

## 4. Pentium® !!! 650/100MHz FSB

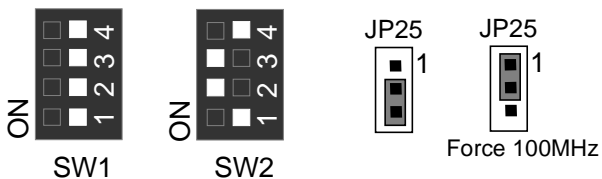

## 5. Pentium® !!! 700/100MHz FSB

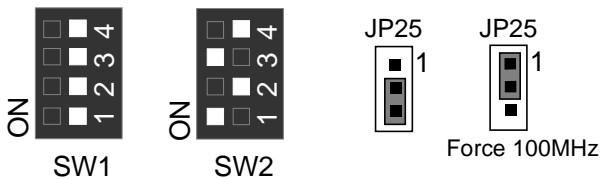

6. Pentium® !!! 750/100MHz FSB

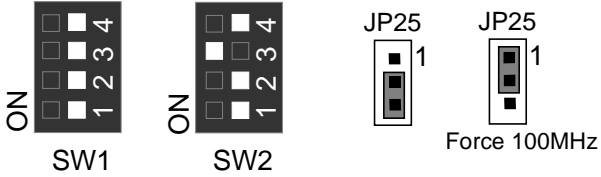

7. Pentium® !!! 800/100MHz FSB

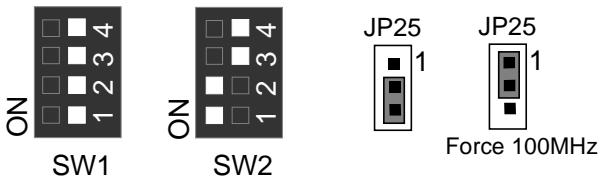

8. Pentium® !!! 850/100MHz FSB

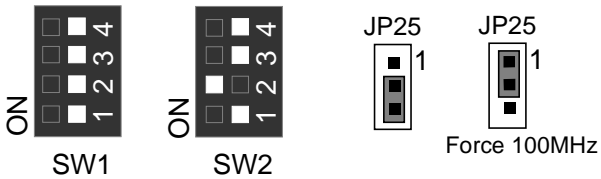

9. Pentium® !!! 533/133MHz FSB

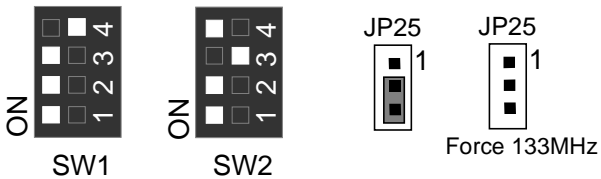

### 10. Pentium® !!! 600/133 MHz FSB

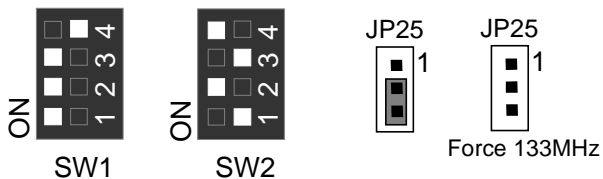

### 11. Pentium® !!! 667/133MHz FSB

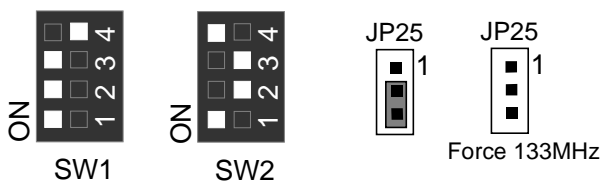

### 12. Pentium® !!! 733/133MHz FSB

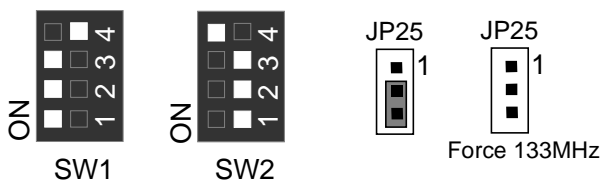

### 13. Pentium® !!! 800/133MHz FSB

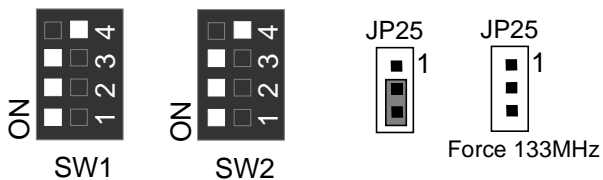

14. Pentium® !!! 866/133MHz FSB

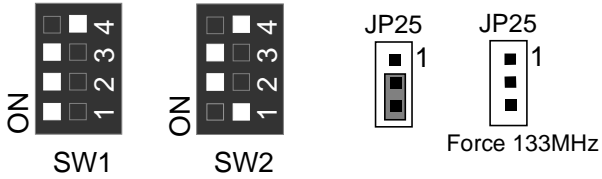

15. Pentium® !!! 933/133MHz FSB

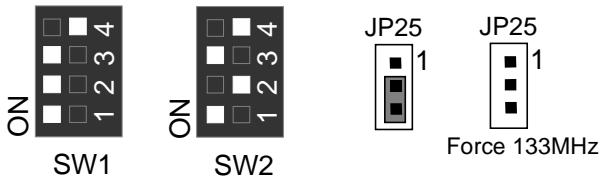

16. Pentium® !!! 1GHz/133MHz FSB

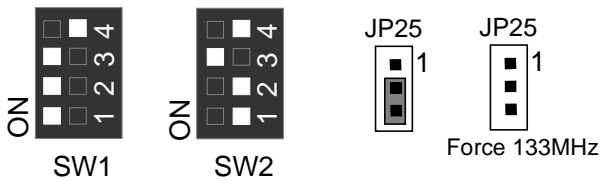

## Connectors

### Game & Audio Port

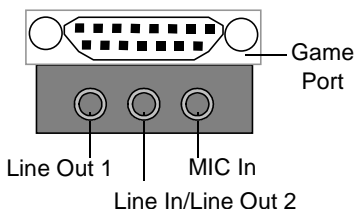
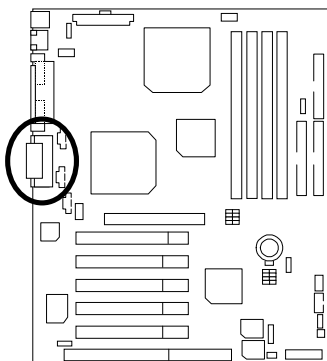

Line Out 1: Line Out or SPDIF (The SPDIF output is capable of providing digital audio to external speakers or compressed AC3 data to an external Dolby digital decoder). In general, Line Out 1 is normally Line Out, when it output digital signal, it will be change to SPDIF Out automatically (see page 38 for more information).

Line In: In general, Line In is normally Line In. When you select "Four Speaker" in Creative application(see page 36 for more information), Line In will be change to Line Out 2, then you can plug 2 pairs stereo speaker into Line Out 1 and Line In simultaneously.

### COM 1 / COM 2 / LPT Port

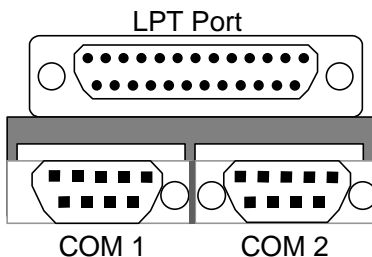
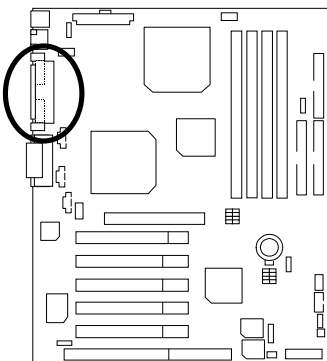

## USB1 Connector

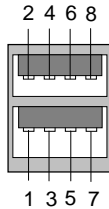
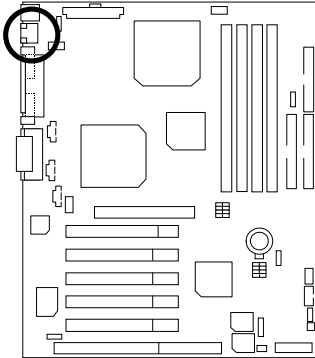

Pin No.	Definition
1	USB V0
2	USB V1
3	USB D0-
4	USB D1-
5	USB D0+
6	USB D1+
7	GND
8	GND

## PS/2 Keyboard &amp; PS/2 Mouse Connector

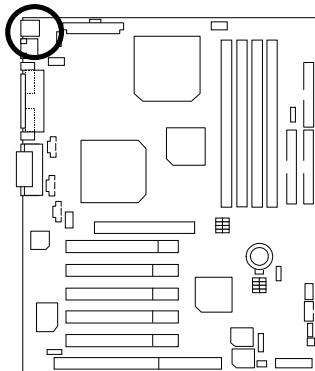

PS/2 Mouse

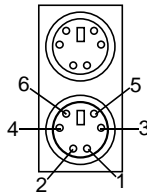

PS/2 Keyboard

PS/2 Mouse/ Keyboard	
Pin No.	Definition
1	Data
2	NC
3	GND
4	VCC(+5V)
5	Clock
6	NC

### J13: CPU1 Fan

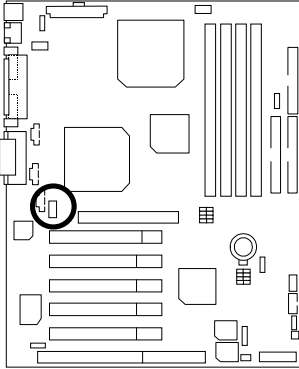

Pin No.	Definition
1	Control
2	+12V
3	SENSE

### J15: CPU2 Fan

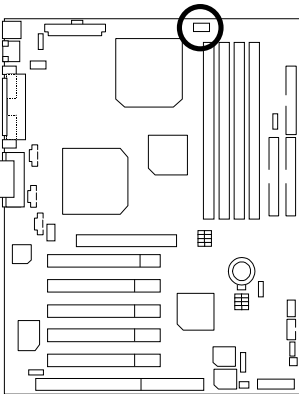

Pin No.	Definition
1	Control
2	+12V
3	SENSE

## J16: Power Fan

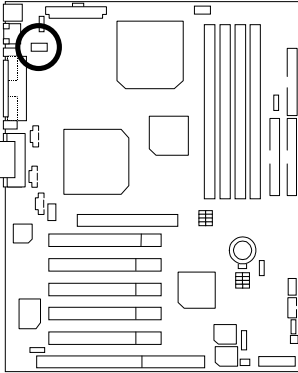

Pin No.	Definition
1	Control
2	+12V
3	NC

## J14: Panel Fan

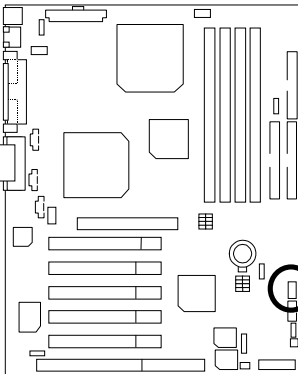

Pin No.	Definition
1	Control
2	+12V
3	NC

### ATX Power

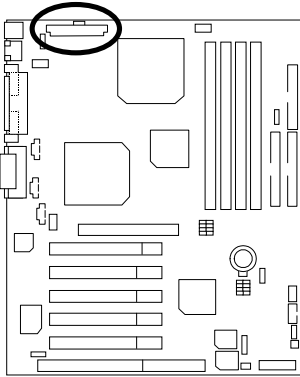

20											11
10											1

Pin No.	Definition
3,5,7,13, 15-17	GND
1,2,11	3.3V
4,6,19,20	VCC
10	+12V
12	-12V
18	-5V
8	Power Good
9	5V SB stand by+5V
14	PS-ON(Soft On/Off)

### Floppy Port

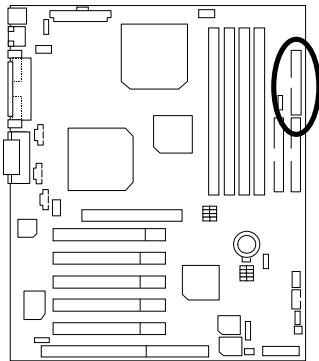

Red Line

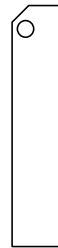

FDD1

## IDE1 (Primary), IDE2 (Secondary) Port

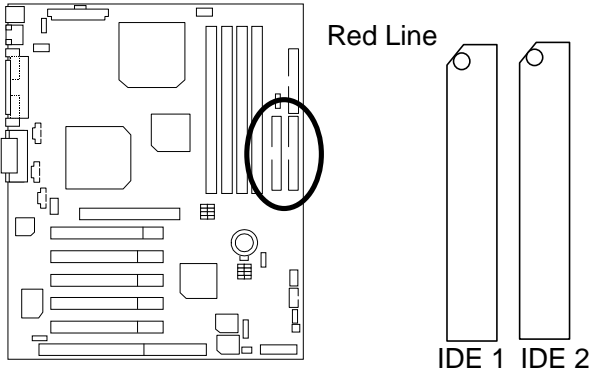

J7 TEL: The connector is for Modem with internal voice connector

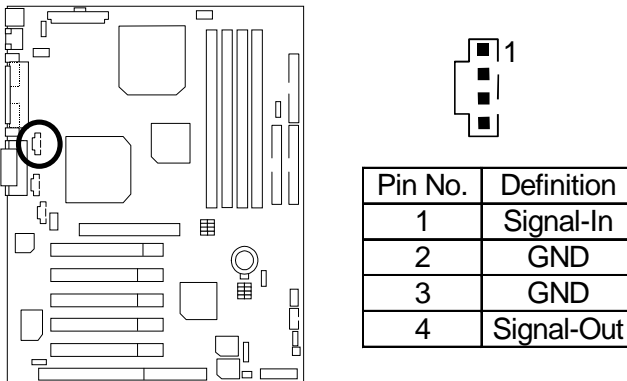

### J5 : AUX\_IN

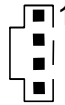
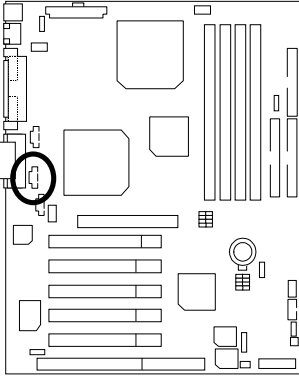

Pin No.	Definition
1	AUX-L
2	GND
3	GND
4	AUX-R

### J8: CD Audio Line In

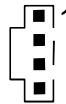
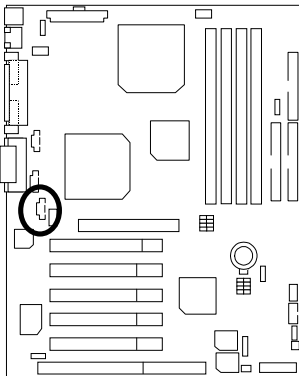

Pin No.	Definition
1	CD-L
2	GND
3	GND
4	CD-R

### J3: Ring Power On (Internal Modem Card Wake Up)

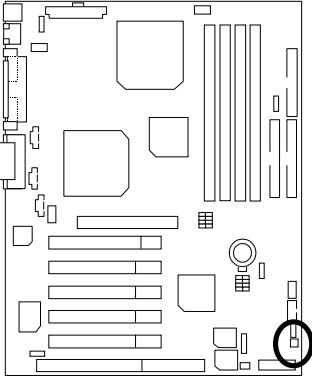

Pin No.	Definition
1	Signal
2	GND

### J1: Wake On LAN

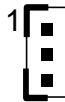
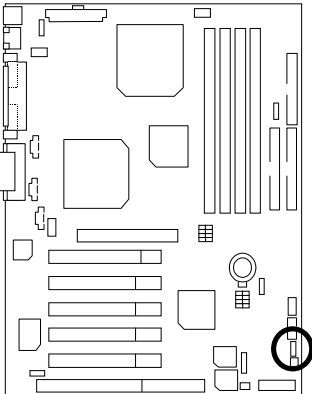

Pin No.	Definition
1	+5V SB
2	GND
3	Signal

J4 : IR

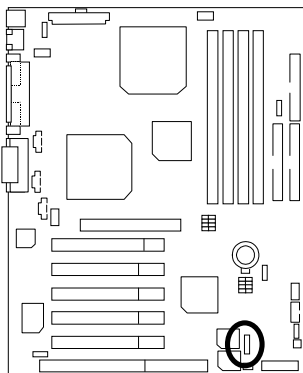

Pin No.	Definition
1	VCC (+5V)
2	NC
3	IR Data Input
4	GND
5	IR Data Output

USB 2 Connector

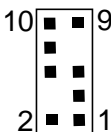
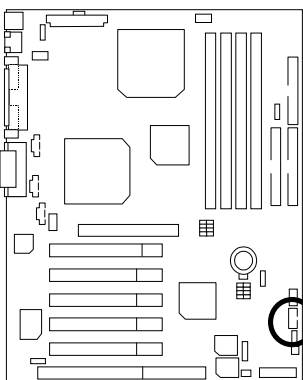

Pin No.	Definition
1,10	+5V
2,9	GND
3	USB D2-
4,7	NC
5	USB D2+
6	USB D3+
8	USB D3-

## Panel And Jumper Definition

### J2: 2x11 Pins Jumper

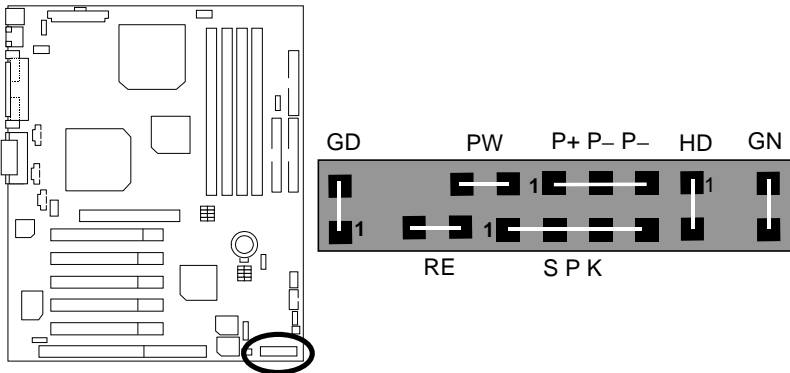

GN (Green Switch)	Open: Normal Operation Close: Entering Green Mode
GD (Green LED)	Pin 1: LED anode(+) Pin 2: LED cathode(-)
HD (IDE Hard Disk Active LED)	Pin 1: LED anode(+) Pin 2: LED cathode(-)
SPK (Speaker Connector)	Pin 1: VCC(+) Pin 2- Pin 3: NC Pin 4: Data(-)
RE (Reset Switch)	Open: Normal Operation Close: Reset Hardware System
P+P-P-(Power LED)	Pin 1: LED anode(+) Pin 2: LED cathode(-) Pin 3: LED cathode(-)
PW (Soft Power Connector)	Open: Normal Operation Close: Power On/Off

### JP1: Clear CMOS Function

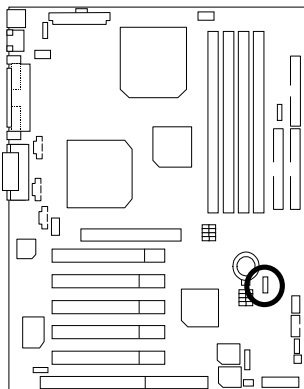

Pin No.	Definition
1-2 Close	Normal (Default)
2-3 Close	Clear CMOS

### JP22: BIOS Flash ROM Write Protect (Optional)

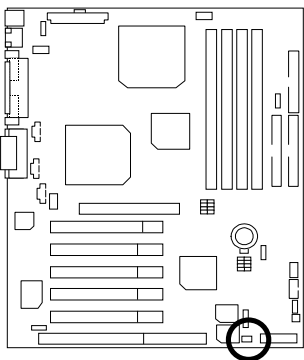

Pin No.	Definition
Close	BIOS Write Protect Enabled
Open	Normal (Default)

⚠ Please set Jumper JP22 to "Open" to enabled BIOS write function when you update new BIOS or new device.

JP20: Onboard Sound Function Selection (Optional)

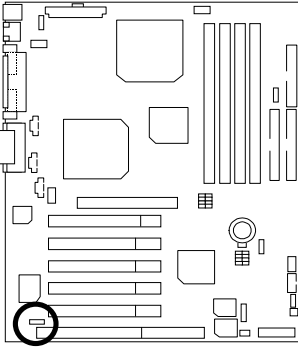

Pin No.	Definition
1-2 close	Enabled Onboard sound (Default)
2-3 close	Disabled Onboard sound

JP9: USB Device Wake up Selection

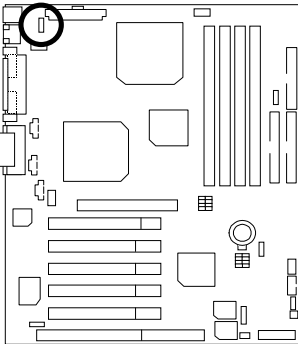

Pin No.	Definition
1-2 close	Normal (Default)
2-3 close	Enabled USB Device Wake up

## BAT1: Battery

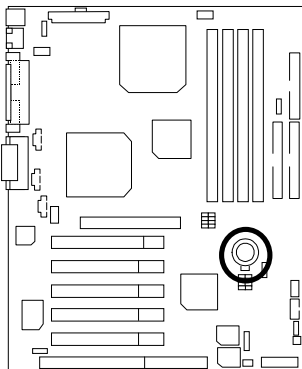

- ⚠ Danger of explosion if battery is incorrectly replaced.
- ⚠ Replace only with the same or equivalent type recommended by the manufacturer.
- ⚠ Dispose of used batteries according to the manufacturer's instructions.

## Performance List

The following performance data list is the testing results of some popular benchmark testing programs.

These data are just referred by users, and there is no responsibility for different testing data values gotten by users. (The different Hardware & Software configuration will result in different benchmark testing results.)

- CPU Intel® Pentium® !!! 800MHz x 2 Socket 370 processor  
Intel® Pentium® !!! 800MHz x 1 Socket 370 processor
- DRAM 256MB SDRAM (Winbond 0180A W981208AH-75)
- CACHE SIZE 256KB Ondie
- DISPLAY GA-GF2560
- STORAGE Onboard IDE (IBM DPTA-353750)
- O.S. Windows NT™ 4.0 SPK6a
- DRIVER Display Driver at 1024 x 768 x 16bit colors x 75Hz.

Processor	Intel® Pentium® !!!	
	800MHz x 2 (133 x 6)	800MHz x 1 (133 x 6)
<b>Winbench99</b>		
CPU mark 99	71.1	71.6
FPU Winmark 99	4230	4230
Business Disk Winmark 99	4800	4980
Hi-End Disk Winmark 99	13200	13300
Business Graphics Winmark 99	329	327
Hi-End Graphics Winmark 99	613	614
<b>Winstone99</b>		
Business Winstone 99	39.8	39.2
Hi-End Winstone 99	45.9	45.6
Dual-Processor Inspection tests	5.79	4.98

## 6VXD7 Motherboard

---

- CPU Intel® Pentium® !!! 600MHz x 2 Socket 370 processor  
Intel® Pentium® !!! 600MHz x 1 Socket 370 processor
- DRAM 256MB SDRAM (Winbond 0180A W981208AH-75)
- CACHE SIZE 256KB Ondie
- DISPLAY GA-GF2560
- STORAGE Onboard IDE (IBM DPTA-353750)
- O.S. Windows NT™ 4.0 SPK6a
- DRIVER Display Driver at 1024 x 768 x 16bit colors x 75Hz.

Processor	Intel® Pentium® !!!	
	600MHz x 2 (100 x 6)	600MHz x 1 (100 x 6)
<b>Winbench99</b>		
CPU mark 99	54.7	54.7
FPU Winmark 99	3180	3170
Business Disk Winmark 99	4850	4580
Hi-End Disk Winmark 99	12700	12600
Business Graphics Winmark 99	255	253
Hi-End Graphics Winmark 99	464	466
<b>Winstone99</b>		
Business Winstone 99	35.8	35.8
Hi-End Winstone 99	39.2	38.1
Dual-Processor Inspection tests	5.28	4.14

- If you wish to maximize the performance of your system, please refer to the detail on P.51

# Block Diagram

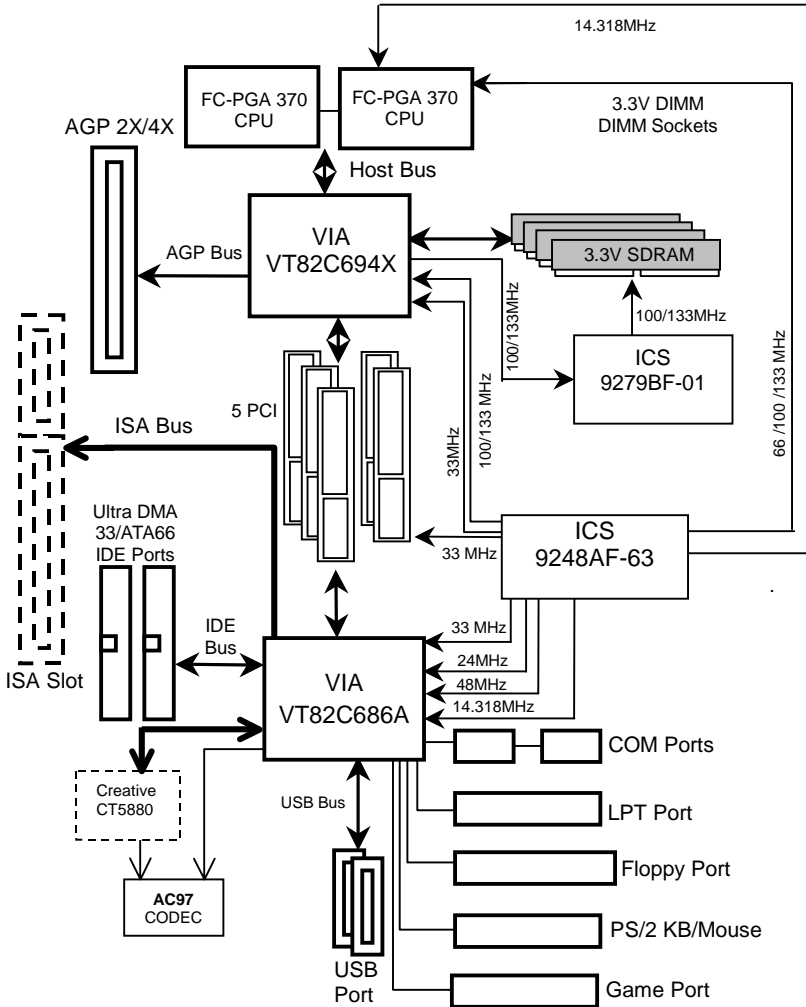

## Dual BIOS Introduction (Optional)

### A. What is Dual BIOS Technology?

Dual BIOS means that there are two system BIOS (ROM) on the motherboard, one is the Main BIOS and the other is Backup BIOS. Under the normal circumstances, the system works on the Main BIOS. If the Main BIOS is corrupted or damaged, the Backup BIOS can take over while the system is powered on. This means that your PC will still be able to run stably as if nothing has happened in your BIOS.

### B. How to use Dual BIOS?

#### a. Boot Screen

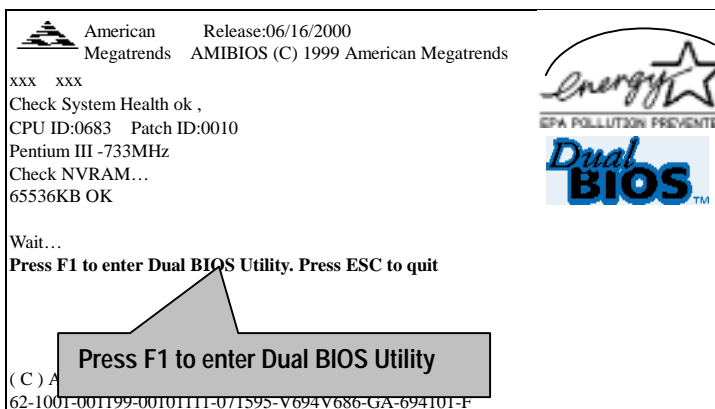

## b. AMI Dual BIOS Flash ROM Programming Utility

AMI Dual BIOS Flash ROM Programming Utility	
Boot From.....	Main BIOS
Main ROM Type.....	SST 39SF020
Backup ROM Type.....	SST 39SF020
<b>Wide Range Protection</b> Disable <b>Boot From</b> Main BIOS <b>Auto Recovery</b> Enable <b>Halt On Error</b> Disable Copy Main ROM Data to Backup Load Default Settings Save Settings to CMOS	
PgDn/PgUp:Modify	↑↓:Move    ESC:Reset    F10:Power Off

## c. Dual BIOS Item explanation:

**BIOS will auto detect:**

**Boot From :** Main BIOS

**Main ROM Type :** SST 39SF020

**Backup ROM Type :** SST 39SF020

**Wide Range Protection: Disable(Default), Enable**

*Status 1:*

If any failure (ex. Update ESCD failure, checksum error or reset...) occurs in the Main BIOS , just before the Operating System is loaded and after the power is on, and that the Wide Range Protection is set to "Enable", the PC will boot from Backup BIOS automatically.

*Status 2:*

If the ROM BIOS on peripherals cards(ex. SCSI Cards, LAN Cards,..) emits signals to request restart of the system after the user make any alteration on it, the boot up BIOS will not be changed to the Backup BIOS.

### **Boot From : Main BIOS (Default), Backup BIOS**

#### *Status 1:*

The user can set to boot from main BIOS or Backup BIOS.

### **Auto Recovery : Enabled(Default), Disabled**

When one of the Main BIOS or Backup BIOS occurs checksum failure, the working BIOS will automatically recover the BIOS of checksum failure.

(In the Power Management Setup of the BIOS Setting, if ACPI Suspend Type is set to Suspend to RAM, the Auto Recovery will be set to Enable automatically.)

(If you want to enter the BIOS setting, please press "Del" key when the boot screen appears.)

### **Halt On Error : Disable(Default), Enable**

If the BIOS occurs a checksum error or the Main BIOS occurs a WIDE RANGE PROTECTION error and Halt On BIOS Defects set to Enable, the PC will show messages on the boot screen, and the system will pause and wait for the user's instruction.

If Auto Recovery: **Disable**, it will show *<or the other key to continue.>*

If Auto Recovery: **Enable**, it will show *<or the other key to Auto Recover.>*

### **Copy Main ROM Data to Backup**

Backup message:

***Are you sure to copy BIOS?***

***[Enter] to continue or [Esc] to abort ...***

The means that the Main BIOS works normally and could automatically recover the Backup BIOS. Or the means that the Backup BIOS works normally and could automatically recover the Main BIOS.

(This auto recovery utility is set by system automatically and can't be changed by user.)



## DualBIOS™ Technology FAQ

GIGABYTE Technology is pleased to introduce DualBIOS technology, a hot spare for your system BIOS. This newness "Value-added" feature, in a long series of innovations from GIGABYTE, is available on GA-6VXD7 motherboard. Future GIGABYTE motherboards will also incorporate this innovation.

### **What's DualBIOS™?**

On GIGABYTE motherboards with DualBIOS there are physically two BIOS chips. For simplicity we'll call one your "Main BIOS" and the other we'll call your "Backup" BIOS (your "hot spare"). If your Main BIOS fails, the Backup BIOS almost automatically takes over on your next system boot. Almost automatically and with virtually zero down time! Whether the problem is a failure in flashing your BIOS or a virus or a catastrophic failure of the Main BIOS chip, the result is the same - the Backup BIOS backs you up, almost automatically.

### **I. Q: What is DualBIOS™ technology?**

#### **Answer:**

DualBIOS technology is a patented technology from Giga-Byte Technology. The concept of this technology is based on the redundancy and fault tolerance theory. DualBIOS™ technology simply means there are two system BIOSes (ROM) integrated onto the motherboard. One is a main BIOS, and the other is a backup BIOS. The mainboard will operate normally with the main BIOS, however, if the main BIOS is corrupt or damaged for various reasons, the backup BIOS will be automatically used when the system powered-On. Your PC will operate as before the main BIOS was damaged, and is completely transparent to the user.

### **II. Q: Why does anyone need a motherboard with DualBIOS™ technology?**

#### **Answer:**

In today's systems there are more and more BIOS failures. The most common reasons are virus attacks, BIOS upgrade failures, and/or deterioration of the BIOS (ROM) chip itself.

1. New computer viruses are being found that attack and destroy the system BIOS. They may corrupt your BIOS code, causing your PC to be unstable or even not boot normally.
2. BIOS data will be corrupted if a power loss/surge occurs, or if a user resets the system, or if the power button is pressed during the process of performing a system BIOS upgrade.
3. If a user mistakenly updates their mainboard with the incorrect BIOS file, then the system may not be able to boot correctly. This may cause the PC system hang in operation or during boot.
4. A flash ROM's life cycle is limited according to electronic characteristics. The modern PC utilizes the Plug and Play BIOS, and is updated regularly. If a user changes peripherals often, there is a slight chance of damage to the flash ROM.

With Giga-Byte Technology's patented DualBIOS™ technology you can reduce the possibility of hangs during system boot up, and/or loss BIOS data due to above reasons. This new technology will eliminate valuable system down time and costly repair bills cause by BIOS failures.

### III. Q: How does DualBIOS™ technology work?

**Answer:**

1. DualBIOS™ technology provides a wide range of protection during the boot up procedure. It protects your BIOS during system POST, ESCD update, and even all the way to PNP detection/assignment.
2. DualBIOS™ provides automatic recovery for the BIOS. When the first BIOS used during boot up does not complete or if a BIOS checksum error occurs, boot-up is still possible. In the DualBIOS™ utility, the "Auto Recovery" option will guarantee that if either the main BIOS or backup BIOS is corrupted, the DualBIOS™ technology will use the good BIOS and correct the wrong BIOS automatically.
3. DualBIOS™ provides manual recovery for the BIOS. DualBIOS™ technology contains a built-in flash utility, which can flash your system BIOS from backup to main and/or visa versa. There is no need for an OS-dependent flash utility program.
4. DualBIOS™ contains a one-way flash utility. The built-in one-way flash utility will ensure that the corrupt BIOS is not mistaken as the good BIOS during recovery and that the correct BIOS (main vs. backup) will be flashed. This will prevent the good BIOS from being flashed.

### IV. Q: Who Needs DualBIOS™ technology?

**Answer:**

1. Every user should have DualBIOS™ technology due to the advancement of computer viruses.  
Everyday, there are new BIOS-type viruses discovered that will destroy your system BIOS. Most commercial products on the market do not have solutions to guard against this type of virus intrusion. The DualBIOS™ technology will provide a state-of-the-art solution to protect your PC:  
Case I.) Vicious computer viruses may wipe out your entire system BIOS. With a conventional single system BIOS PC, the PC will not be functional until it is sent for repairs.  
Case II.) If the "Auto Recovery" option is enabled in the DualBIOS™ utility, and if a virus corrupts your system BIOS, the backup BIOS will automatically reboot the system and correct the main BIOS.  
Case III.) A user may override booting from the main system BIOS. The DualBIOS™ utility may be entered to manually change the boot sequence to boot from the backup BIOS.

2. During or after a BIOS upgrade, if DualBIOS™ detects that the main BIOS is corrupt, the backup BIOS will take over the boot-up process automatically. Moreover, it will verify the main and backup BIOS checksums when booting-up. DualBIOS™ technology examines the checksum of the main and backup BIOS while the system is powered on to guarantee your BIOS operates properly.
3. Power Users will have the advantage of having two BIOS versions on their mainboard. The benefit is being able to select either version BIOS to suit the performance system needs.
4. Flexibility for high-end desktop PCs and workstation/servers. In the DualBIOS™ utility, the option can be set, "Halt On When BIOS Defects," to be enabled to halt your system with a warning message that the main BIOS has been corrupted. Most workstation/servers require constant operation to guarantee services have not been interrupted. In this situation, the "Halt On When BIOS Defects" message may be disabled to avoid system pauses during normal booting. Another advantage you gain from Giga-Byte's DualBIOS™ technology is the ability to upgrade from dual 2 Mbit BIOS to dual 4 Mbit BIOS in the future if extra BIOS storage is need.

## Four Speaker & SPDIF Introduction (Optional)

### Four Speaker Introduction

#### A. What is Four Speaker?

The Creative CT5880 audio chip can support 4 speaker output, if you select "Four speaker" out, Line in will be change to another line out.

#### B. How to use Four Speaker?

- a. Press the "Start" button and then select "Creative" → "Sound Blaster PCI128" → "Creative Configurator".

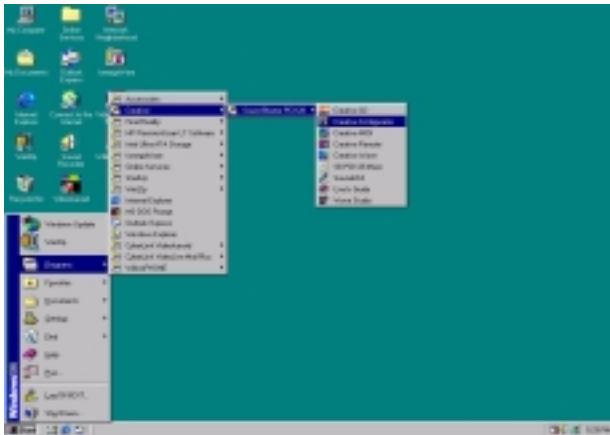

- b. Click "3D Configuration" item.

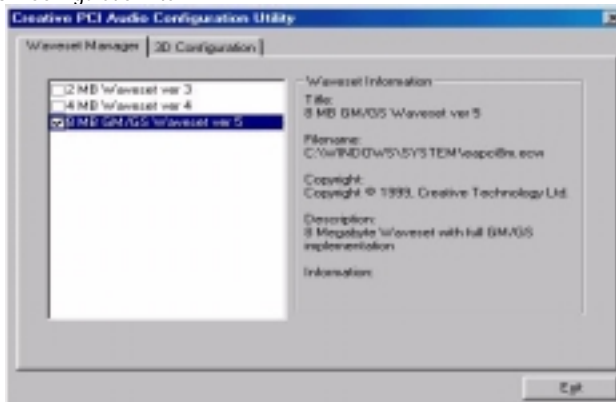

c. Two speaker (Default)

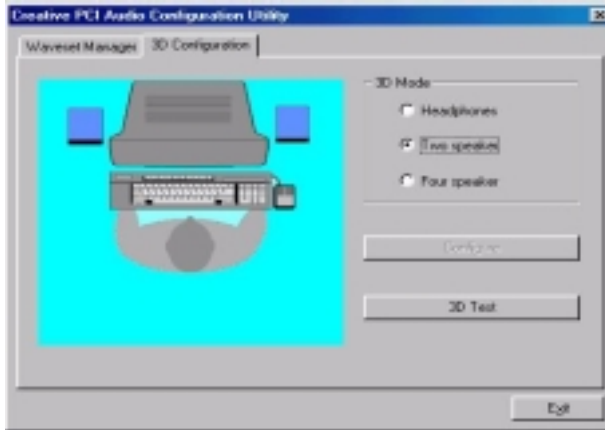

d. Click "Four speaker" item.



**C. Four Speaker Application**

The four speaker function will only support in application software that use Microsoft DirectX and Creative EAX. For example, the game titles, software DVD player and MP3 player. Those software support Microsoft DirectX, so they can support four speaker output.

## SPDIF Introduction

### A. What is SPDIF?

The SPDIF output is capable of providing digital audio to external speakers or compressed AC3 data to an external Dolby digital decoder.

### B. How to use SPDIF?

a. Press your mouse right button in "My Computer" and then select the "Properties" item.

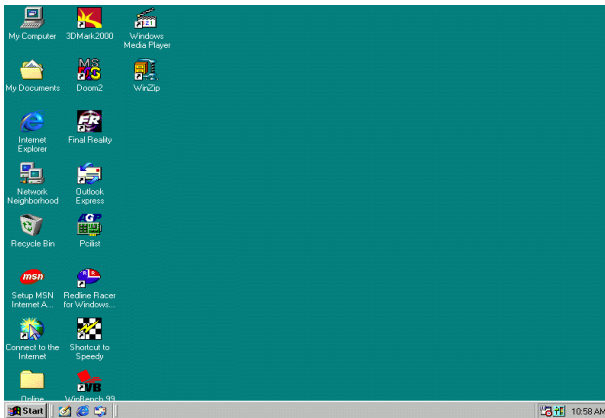

b. Click "Device Manager" item.



- c. Press "Sound, video and game controllers" item and then select the "Creative Sound Blaster PCI128" item.

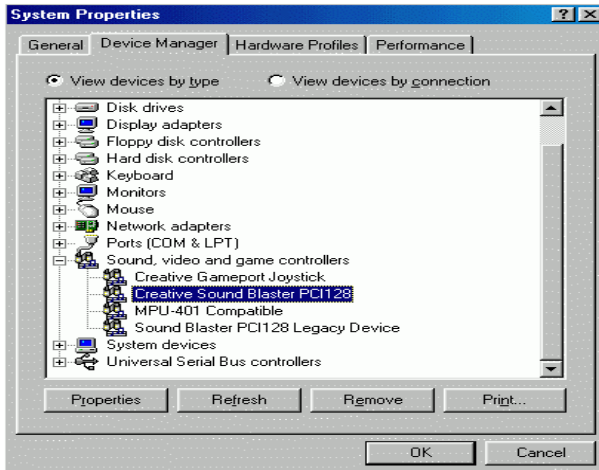

- d. Press "Settings" item and then select the "Output Mode" item.

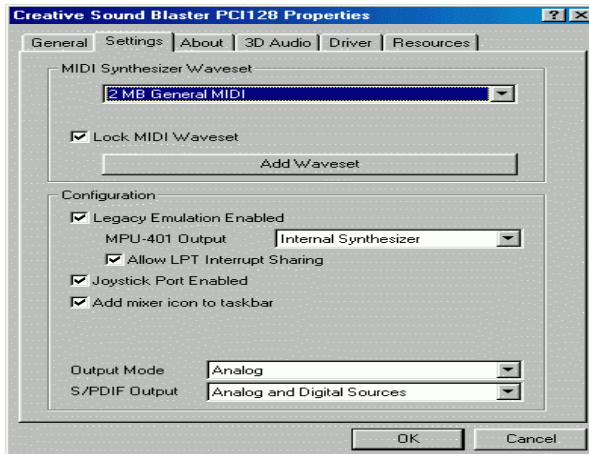

e. Click "Digital" item, Line Out will be change to SPDIF Out.

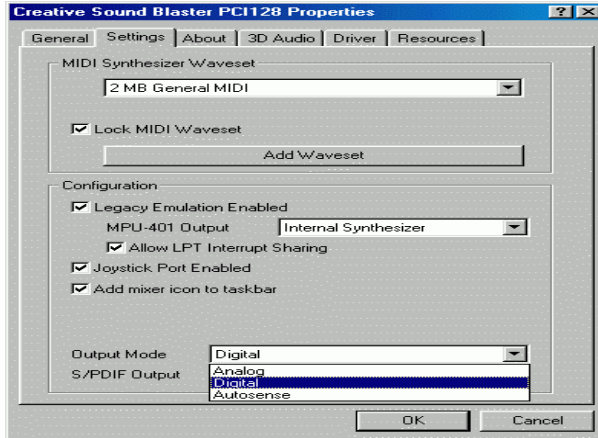

f. Recommend you to select "Autosense", it will auto detect the audio jack you plug in to Line Out is mono or stereo, and then change to SPDIF Out or Speaker out automatically.

## Memory Installation

The motherboard has 4 dual inline memory module (DIMM) sockets. The BIOS will automatically detects memory type and size. To install the memory module, just push it vertically into the DIMM Slot .The DIMM module can only fit in one direction due to the two notch. Memory size can vary between sockets.

Install memory in any combination table:

DIMM	168-pin SDRAM DIMM Modules	
DIMM 1	Supports 16 / 32 / 64 / 128 / 256 / 512 MB	X 1 pcs
DIMM 2	Supports 16 / 32 / 64 / 128 / 256 / 512 MB	X 1 pcs
DIMM 3	Supports 16 / 32 / 64 / 128 / 256 / 512 MB	X 1 pcs
DIMM 4	Supports 16 / 32 / 64 / 128 / 256 / 512 MB	X 1 pcs

★Total System Memory (Max 2GB)

 Page Index for BIOS Setup	Page
The Main Menu	P.44
Standard CMOS Setup	P.46
BIOS Features Setup	P.49
Chipset Features Setup	P.51
Power Management Setup	P.54
PNP/PCI Configuration	P.57
Load BIOS Defaults	P.59
Load Setup Defaults	P.60
Integrated Peripherals	P.61
Hardware Monitor	P.64
Supervisor Password / User Password	P.66
IDE HDD Auto Detection	P.67
Save & Exit Setup	P.68
Exit Without Saving	P.69

## BIOS Setup

BIOS Setup is an overview of the BIOS Setup Program. The program that allows users to modify the basic system configuration. This type of information is stored in battery-backed CMOS RAM so that it retains the Setup information when the power is turned off.

### ENTERING SETUP

Power ON the computer and press <Del> immediately will allow you to enter Setup. If the message disappears before you respond and you still wish to enter Setup, restart the system to try again by turning it OFF then ON or pressing the "RESET" bottom on the system case. You may also restart by simultaneously press <Ctrl> – <Alt>– <Del> keys.

### CONTROL KEYS

<↑>	Move to previous item
<↓>	Move to next item
<←>	Move to the item in the left hand
<→>	Move to the item in the right hand
<Esc>	Main Menu - Quit and not save changes into CMOS Status Page Setup Menu and Option Page Setup Menu - Exit current page and return to Main Menu
<+/PgUp>	Increase the numeric value or make changes
<-/PgDn>	Decrease the numeric value or make changes
<F1>	General help, only for Status Page Setup Menu and Option Page Setup Menu
<F2>	Reserved
<F3>	Reserved
<F4>	Reserved
<F5>	Restore the previous CMOS value from CMOS, only for Option Page Setup Menu
<F6>	Load the default CMOS value from BIOS default table, only for Option Page Setup Menu
<F7>	Load the Setup Defaults.
<F8>	Reserved
<F9>	Reserved
<F10>	Save all the CMOS changes, only for Main Menu

## GETTING HELP

### Main Menu

The on-line description of the highlighted setup function is displayed at the bottom of the screen.

### Status Page Setup Menu / Option Page Setup Menu

Press F1 to pop up a small help window that describes the appropriate keys to use and the possible selections for the highlighted item. To exit the Help Window press <Esc>.

## The Main Menu

Once you enter AMI BIOS CMOS Setup Utility, the Main Menu (Figure 1) will appear on the screen. The Main Menu allows you to select from nine setup functions and two exit choices. Use arrow keys to select among the items and press <Enter> to accept or enter the sub-menu.

AMIBIOS SIMPLE SETUP UTILITY-VERSION 1.22 ( C ) 1999 American Megatrends, Inc. All Rights Reserved	
STANDARD CMOS SETUP	INTEGRATED PERIPHERALS
BIOS FEATURES SETUP	HARDWARE MONITOR SETUP
CHIPSET FEATURES SETUP	SUPERVISOR PASSWORD
POWER MANAGEMENT SETUP	USER PASSWORD
PNP/PCI CONFIGURATION	IDE HDD AUTO DETECTION
LOAD BIOS DEFAULTS	SAVE & EXIT SETUP
LOAD SETUP DEFAULTS	EXIT WITHOUT SAVING
ESC : Quit      ↑↓←→ : Select Item      (Shift) F2 : Change Color      F5 : Old Values F6 : Load BIOS Defaults      F7: Load Setup Defaults      F10: Save & Exit	
Time, Date, Hard Disk Type, ...	

Figure 1: Main Menu

- **Standard CMOS Setup**

This setup page includes all the items in standard compatible BIOS.

- **BIOS Features Setup**

This setup page includes all the items of AMI special enhanced features.

- **Chipset Features Setup**

This setup page includes all the items of chipset special features.

- **Power Management Setup**

This setup page includes all the items of Green function features.

- **PnP/PCI Configurations**

This setup page includes all the configurations of PCI & PnP ISA resources.

- **Load BIOS Defaults**

Bios Defaults indicates the value of the system parameter which the system would be in the safe configuration.

- **Load Setup Defaults**

Setup Defaults indicates the value of the system parameter which the system would be in the most appropriate configuration.

- **Integrated Peripherals**

This setup page includes all onboard peripherals.

- **Hardware Monitor Setup**

This setup page is auto detect fan and temperature status.

- **Supervisor password**

Change, set, or disable password. It allows you to limit access to the system and Setup, or just to Setup.

- **User password**

Change, set, or disable password. It allows you to limit access to the system.

- **IDE HDD auto detection**

Automatically configure hard disk parameters.

- **Save & Exit Setup**

Save CMOS value settings to CMOS and exit setup.

- **Exit Without Saving**

Abandon all CMOS value changes and exit setup.

## Standard CMOS Setup

The items in Standard CMOS Features Menu (Figure 2) are divided into 9 categories. Each category includes no, one or more than one setup items. Use the arrows to highlight the item and then use the <PgUp> or <PgDn> keys to select the value you want in each item.

AMIBIOS SETUP – STANDARD CMOS SETUP ( C ) 1999 American Megatrends, Inc. All Rights Reserved	
Date (mm/dd/yyyy) : Tue Mar 07, 2000 Time (hh/mm/ss) : 10:36:24	
	TYPE SIZE CYLS HEAD PRECOMP LANDZ SECTOR MODE
Pri Master : Auto	
Pri Slave : Auto	
Sec Master : Auto	
Sec Slave : Auto	
Floppy Drive A: 1.44 MB 3 ½	Base Memory : 640 Kb
Floppy Drive B: Not Installed	Other Memory: 384 Kb
	Extended Memory: 31Mb
Boot Sector Virus Protection : Disabled	Total Memory: 32Mb
Month : Jan – Dec	ESC : Exit
Day : 01 – 31	↑↓ : Select Item
Year : 1990–2099	PU/PD/+/- : Modify
	(Shift)F2 : Color

Figure 2: Standard CMOS Setup

- **Date**

The date format is <Week> <Month> <Day>, <Year>.

Week	The week, from Sun to Sat, determined by the BIOS and is display-only
Month	The month, Jan. Through Dec.
Day	The day, from 1 to 31 (or the maximum allowed in the month)
Year	The year, from 1990 through 2099

- **Time**

The times format in <hour> <minute> <second>. The time is calculated base on the 24-hour military-time clock. For example, 1 p.m. is 13:00:00.

- **Primary Master, Slave / Secondary Master, Slave**

The category identifies the types of hard disk from drive C to F that has been installed in the computer. There are two types: auto type, and user definable type. User type is user-definable; Auto type which will automatically detect HDD type.

Note that the specifications of your drive must match with the drive table. The hard disk will not work properly if you enter improper information for this category.

If you select User Type, related information will be asked to enter to the following items. Enter the information directly from the keyboard and press <Enter>. Such information should be provided in the documentation form your hard disk vendor or the system manufacturer.

CYLS.	Number of cylinders
HEADS	number of heads
PRECOMP	write precomp
LANDZONE	Landing zone
SECTORS	number of sectors

If a hard disk has not been installed select NONE and press <Enter>.

- **Floppy Drive A / Floppy Drive B**

The category identifies the types of floppy disk drive A or drive B that has been installed in the computer.

None	No floppy drive installed
360K, 5.25 in.	5.25 inch PC-type standard drive; 360K byte capacity.
1.2M, 5.25 in.	5.25 inch AT-type high-density drive; 1.2M byte capacity (3.5 inch when 3 Mode is Enabled).
720K, 3.5 in.	3.5 inch double-sided drive; 720K byte capacity
1.44M, 3.5 in.	3.5 inch double-sided drive; 1.44M byte capacity.
2.88M, 3.5 in.	3.5 inch double-sided drive; 2.88M byte capacity.

- **Boot Sector Virus Protection**

If it is set to enable, the category will flash on the screen when there is any attempt to write to the boot sector or partition table of the hard disk drive. The system will halt and the following error message will appear in the mean time. You can run anti-virus program to locate the problem.

Enabled	Activate automatically when the system boots up causing a warning message to appear when anything attempts to access the boot sector or hard disk partition table
Disabled	No warning message to appear when anything attempts to access the boot sector or hard disk partition table. <b>(Default Value)</b>

- **Memory**

The category is display-only which is determined by POST (Power On Self Test) of the BIOS.

#### Base Memory

The POST of the BIOS will determine the amount of base (or conventional) memory installed in the system.

The value of the base memory is typically 512 K for systems with 512 K memory installed on the motherboard, or 640 K for systems with 640 K or more memory installed on the motherboard.

#### Extended Memory

The BIOS determines how much extended memory is present during the POST.

This is the amount of memory located above 1 MB in the CPU's memory address map.

#### Other Memory

This refers to the memory located in the 640 K to 1024 K address space. This is memory that can be used for different applications.

DOS uses this area to load device drivers to keep as much base memory free for application programs. Most use for this area is Shadow RAM



- **Boot Up Num-Lock**

On	Keypad is number keys. <b>(Default Value)</b>
Off	Keypad is arrow keys.

- **Floppy Drive Seek**

During POST, BIOS will determine if the floppy disk drive installed is 40 or 80 tracks. 360 type is 40 tracks while 720 , 1.2 and 1.44 are all 80 tracks.

Enabled	BIOS searches for floppy disk drive to determine if it is 40 or 80 tracks. Note that BIOS can not tell from 720, 1.2 or 1.44 drive type as they are all 80 tracks. <b>(Default Value)</b>
Disabled	BIOS will not search for the type of floppy disk drive by track number. Note that there will not be any warning message if the drive installed is 360.

- **Password Check**

Setup	Set Password Check to Setup. <b>(Default Value)</b>
Always	Set Password Check to Always.

- **Processor Serial Number**

This item will show up when you install the Pentium® !!! Processor.

Disabled	Disabled Processor Serial Number. <b>(Default Value)</b>
Enabled	Enabled Processor Serial Number.

- **BIOS Write Protect**

Enabled	Enabled BIOS Write Protect.
Disabled	Disabled BIOS Write Protect. <b>(Default Value)</b>

## Chipset Features Setup

AMIBIOS SETUP –CHIPSET FEATURE CMOS SETUP ( C ) 1999 American Megatrends, Inc. All Rights Reserved	
*** DRAM Timing ***	
Top Performance	:Disabled
SDRAM Timing by SPD	:Disabled
SDRAM CAS# Latency	:Auto
CPU/DRAM Frequency	:Auto
C2P Concurrency & Master	:Enabled
DRAM Integrity Mode	:Disabled
AGP Mode	:4X
AGP Comp. Driving	:Auto
Manual AGP Comp. Driving	:CB
AGP Aperture Size	:64MB
USB Controller	:All USB Port
USB Legacy Support	:Disabled
ESC : Quit                    ↑↓←→: Select Item F1: Help                     PU/PD/+/- : Modify F5 : Old Values            (Shift)F2 :Color F6 : Load BIOS Defaults F7 : Load Setup Defaults	

Figure 4: Chipset Features Setup

- **Top Performance**

If you wish to maximize the performance of your system, set "Top Performance" as "Enabled".

Disabled	Disabled this function. <b>(Default Value)</b>
Enabled	Enabled Top Performance function.

- **SDRAM Timing by SPD**

Disabled	SDRAM Timing by SPD Function Disabled. <b>(Default Value)</b>
Enabled	SDRAM Timing by SPD Function Enabled.

- **SDRAM CAS# Latency**

Auto	Detect SDRAM CAS# Latency by SPD. <b>(Default Value)</b>
3	For Slower SDRAM DIMM module.
2	For Fastest SDRAM DIMM module.

- **CPU/DRAM Frequency**

1. System Bus Speed: 100MHz

Auto	Set CPU/DRAM Frequency to Auto. <b>(Default Value)</b>
100/100MHz	Set CPU/DRAM Frequency is 100/100MHz.
100/133MHz	Set CPU/DRAM Frequency is 100/133MHz.

2. System Bus Speed: 133MHz

Auto	Set CPU/DRAM Frequency to Auto. <b>(Default Value)</b>
133/100MHz	Set CPU/DRAM Frequency is 133/100MHz.
133/133MHz	Set CPU/DRAM Frequency is 133/133MHz.

- **C2P Concurrency & Master**

Enabled	Enabled C2P Concurrency & Master. <b>(Default Value)</b>
Disabled	Disabled C2P Concurrency & Master.

- **DRAM Integrity Mode**

ECC	For 72 bit ECC type DIMM Module.
Disabled	Normal Setting. <b>(Default Value)</b>

- **AGP Mode**

4X	Set AGP Mode is 4X. <b>(Default Value)</b>
1X	Set AGP Mode is 1X.
2X	Set AGP Mode is 2X.

- **AGP Comp. Driving**

Auto	Set AGP Comp. Driving is Auto. <b>(Default Value)</b>
Manual	Set AGP Comp. Driving is Manual.

If AGP Comp. Driving is Manual.

Manual AGP Comp. Driving :	00-FF
----------------------------	-------

- **AGP Aperture Size**

4MB	Set AGP Aperture Size to 4MB.
8MB	Set AGP Aperture Size to 8 MB.
16MB	Set AGP Aperture Size to 16 MB.
32MB	Set AGP Aperture Size to 32 MB.
64MB	Set AGP Aperture Size to 64 MB. <b>(Default Value)</b>
128MB	Set AGP Aperture Size to 128 MB.
256MB	Set AGP Aperture Size to 256 MB.

- **USB Controller**

USB Port 0&1	USB Controller for USB Port 0&1.
USB Port 2&3	USB Controller for USB Port 2&3.
All USB Port	USB Controller for All USB Port. <b>(Default Value)</b>
Disabled	USB Controller Function Disabled.

- **USB Legacy Support**

Keyboard	Set USB Legacy Support Keyboard.
Keyb+Mouse	Set USB Legacy Support Keyboard +Mouse.
Disabled	Disabled USB Legacy Support Function. <b>(Default Value)</b>

## Power Management Setup

AMIBIOS SETUP –POWER MANAGEMENT SETUP ( C ) 1999 American Megatrends, Inc. All Rights Reserved			
USB Wakeup From S4-S5	:Disabled	RTC Alarm Power On	:Disabled
Video Power Down Mode	:Stand By	RTC Alarm Date	:15
Hard Disk Power Down Mode	:Stand By	RTC Alarm Hour	:12
Suspend Time Out(Minute)	:Disabled	RTC Alarm Minute	:30
Display Activity	:Ignore	RTC Alarm Second	:30
IRQ3	:Monitor		
IRQ 4	:Monitor		
IRQ 5	:Ignore		
IRQ 7	:Monitor		
IRQ 9	:Ignore		
IRQ 10	:Ignore		
IRQ 11	:Ignore		
IRQ 13	:Ignore		
IRQ 14	:Monitor		
IRQ 15	:Ignore		
Soft-off by Power Button	:Instant off		
AC Back Function	:Soft Off	ESC : Quit	↑↓←→: Select Item
Modem Use IRQ	:4	F1 : Help	PU/PD/+/- : Modify
Modem Ring On/Wake On Lan	:Enabled	F5 : Old Values	(Shift)F2 :Color
PME Event Wake up	:Enabled	F6 : Load BIOS Defaults	
		F7 : Load Setup Defaults	

Figure 5: Power Management Setup

- **USB Wakeup From S4-S5**

Enabled	Enabled USB Wakeup From S4-S5.
Disabled	Disabled USB Wakeup From S4-S5. <b>(Default Value)</b>

- **Video Power Down Mode**

Disabled	Disabled Video Power Down Mode Function.
Suspend	Set Video Power Down Mode to Suspend.
Stand By	Set Video Power Down Mode to Stand By. <b>(Default Value)</b>

- **Hard Disk Power Down Mode**

Disabled	Disabled Hard Disk Power Down Mode Function.
Suspend	Set Hard Disk Power Down Mode to Suspend
Stand By	Set Hard Disk Power Down Mode to Stand By. <b>(Default Value)</b>

- **Suspend Time Out (Minute.)**

Disabled	Disabled Suspend Time Out Function. <b>(Default Value)</b>
1	Enabled Suspend Time Out after 1min.
2	Enabled Suspend Time Out after 2min.
4	Enabled Suspend Time Out after 4min.
8	Enabled Suspend Time Out after 8min.
10	Enabled Suspend Time Out after 10min.
20	Enabled Suspend Time Out after 20min.
30	Enabled Suspend Time Out after 30min.
40	Enabled Suspend Time Out after 40min.
50	Enabled Suspend Time Out after 50min.
60	Enabled Suspend Time Out after 60min.

- **Display Activity**

Ignore	Ignore Display Activity. <b>(Default Value)</b>
Monitor	Monitor Display Activity.

- **IRQ 3-IRQ15**

Ignore	Ignore IRQ3 -IRQ15.
Monitor	Monitor IRQ3-IRQ15.

- **Soft-off by Power Button**

Instant off	Press power button then Power off instantly. <b>(Default Value)</b>
Delay-4Sec	Press power button 4 sec to Power off. Enter suspend if button is pressed less than 4 sec.

- **AC Back Function**

Memory	System power on depends on the status before AC lost.
Soft-Off	Always in Off state when AC back. <b>(Default value)</b>
Full-On	Always power on the system when AC back.

- **MODEM Use IRQ**

NA	Set MODEM Use IRQ to NA.
3	Set MODEM Use IRQ to 3.
4	Set MODEM Use IRQ to 4. <b>(Default Value)</b>
5	Set MODEM Use IRQ to 5.
7	Set MODEM Use IRQ to 7.

- **Modem Ring On/Wake On Lan**

Disabled	Disabled Modem Ring On/Wake On Lan.
Enabled	Enabled Modem Ring On/Wake On Lan. <b>(Default Value)</b>

- **PME Event Wake up**

Disabled	Disabled PME Event Wake up function.
Enabled	Enabled PME Event Wake up function. <b>(Default Value)</b>

- **RTC Alarm Power On**

You can set "RTC Alarm Power On" item to Enabled and key in date/time to power on system.

Disabled	Disable this function. <b>(Default Value)</b>
Enabled	Enable alarm function to POWER ON system.

If the "RTC Alarm Power On" is Enabled.

RTC Alarm Date :	Every Day,1~31
RTC Alarm Hour:	0~23
RTC Alarm Minute :	0~59
RTC Alarm Second :	0~59

## PNP/PCI Configuration

AMIBIOS SETUP –PNP/PCI CONFIGURATION SETUP ( C ) 1999 American Megatrends, Inc. All Rights Reserved	
Plug and Play Aware O/S	:No
Reset Configuration Data	:No
VGA Boot From	:AGP
PCI VGA Palette Snoop	:Disabled
DMA Channel 0	:PnP
DMA Channel 1	:PnP
DMA Channel 3	:PnP
DMA Channel 5	:PnP
DMA Channel 6	:PnP
DMA Channel 7	:PnP
IRQ 3	:PCI/PnP
IRQ 4	:PCI/PnP
IRQ 5	:PCI/PnP
IRQ 7	:PCI/PnP
IRQ 9	:PCI/PnP
IRQ 10	:PCI/PnP
IRQ 11	:PCI/PnP
IRQ 14	:PCI/PnP
IRQ 15	:PCI/PnP
ESC : Quit                    ↑↓←→: Select Item F1 : Help                    PU/PD/+/- : Modify F5 : Old Values            (Shift)F2 :Color F6 : Load BIOS Defaults F7 : Load Setup Defaults	

Figure 6: PNP/PCI Configuration

- **Plug and Play Aware O/S**

Yes	Enable Plug and Play Aware O/S function.
No	Disable Plug and Play Aware O/S function <b>(Default Value)</b>

- **Reset Configuration Data**

Yes	Clear PnP information in ESCD & update DMI data.
No	Disabled this function. <b>(Default Value)</b>

- **VGA Boot From**

AGP	Primary Graphics Adapter From AGP. <b>(Default Value)</b>
PCI	Primary Graphics Adapter From PCI.

- **PCI VGA Palette Snoop**

Enabled	For having Video Card on ISA Bus and VGA Card on PCI Bus.
Disabled	For VGA Card only. <b>(Default Value)</b>

---

- **DMA Channel (0,1,3,5,6,7)**

PnP	The resource is used by PnP device.
ISA/EISA	The resource is used by ISA / EISA device (PCI or ISA).

- **IRQ (3,4,5,7, 9,10,11,14,15)**

PCI/PnP	The resource is used by PCI/PnP device.
ISA/EISA	The resource is used by ISA / EISA device (PCI or ISA).

## Load BIOS Defaults

AMIBIOS SIMPLE SETUP UTILITY-VERSION 1.22 ( C ) 1999 American Megatrends, Inc. All Rights Reserved	
STANDARD CMOS SETUP	INTEGRATED PERIPHERALS
BIOS FEATURES SETUP	HARDWARE MONITOR SETUP
CHIPSET FEATURES SETUP	SUPERVISOR PASSWORD
POWER MANAGEMENT SETUP	USER PASSWORD
PNP/PCI CONFIGURATION	
LOAD BIOS DEFAULTS	
LOAD SETUP DEFAULTS	EXIT WITHOUT SAVING
ESC : Quit    ↑↓→← : Select Item    (Shift) F2 : Change Color    F5 : Old Values F6 : Load BIOS Defaults    F7: Load Setup Defaults    F10: Save & Exit	
Load BIOS Default except Standard CMOS Setup	

Figure 7: Load BIOS Defaults

- **Load BIOS Defaults**

BIOS defaults contain the most appropriate values of the system parameters that allow minimum system performance.

## Load Setup Defaults

AMIBIOS SIMPLE SETUP UTILITY-VERSION 1.22 ( C ) 1999 American Megatrends, Inc. All Rights Reserved	
STANDARD CMOS SETUP	INTEGRATED PERIPHERALS
BIOS FEATURES SETUP	HARDWARE MONITOR SETUP
CHIPSET FEATURES SETUP	SUPERVISOR PASSWORD
POWER MANAGE	
PNP/PCI CONFIGURATION	FUNCTION
LOAD BIOS DEFAULTS	SAVE & EXIT SETUP
LOAD SETUP DEFAULTS	EXIT WITHOUT SAVING
ESC : Quit    ↑↓→← : Select Item    (Shift) F2 : Change Color    F5 : Old Values F6 : Load BIOS Defaults    F7: Load Setup Defaults    F10: Save & Exit	
Load Setup Default except Standard CMOS Setup	

Figure 8: Load Setup Defaults

- **Load Setup Defaults**

Selecting this field loads the factory defaults for BIOS and Chipset Features which the system automatically detects.

## Integrated Peripherals

AMIBIOS SETUP –INTEGRATED PERIPHERAL ( C ) 1999 American Megatrends, Inc. All Rights Reserved	
OnBoard IDE	:Both
OnBoard FDC	:Auto
OnBoard Serial Port 1	:Auto
OnBoard Serial Port 2	:Auto
Serial Port 2 Mode	:Normal
*Duplex Mode	:N/A
OnBoard Parallel Port	:Auto
Parallel Port Mode	:ECP
Parallel Port DMA	:Auto
Parallel Port IRQ	:Auto
◆ OnBoard Legacy Audio	:Enabled
◆ Sound Blaster	:Disabled
◆ SB I/O Base Address	:220h-22Fh
◆ SB IRQ Select	:IRQ 5
◆ SB DMA Select	:DMA 1
◆ MPU-401	:Disabled
◆ MPU-401 I/O Address	:330h-333h
◆ FM Port(388h-38Bh)	:Disabled
◆ Game Port(200h-207h)	:Enabled
Onboard Midi In/Out	:Disabled
ESC : Quit                    ↑↓←→: Select Item F1 : Help                    PU/PD/+/- : Modify F5 : Old Values              (Shift)F2 :Color F6 : Load BIOS Defaults F7 : Load Setup Defaults	

Figure 9: Integrated Peripherals

\*This item will be available when "Serial Port 2 Mode" is set to IrDA or ASK IR.

◆ These nine items will be shown when there are only AC'97 CODEC sound.

### ● OnBoard IDE

Disabled	Disabled OnBoard IDE
Both	Set OnBoard IDE to Both. <b>(Default Value)</b>
Primary	Set OnBoard IDE to Primary.
Secondary	Set OnBoard IDE to Secondary.

### ● OnBoard FDC

Auto	Set OnBoard FDC to Auto. <b>(Default Value)</b>
Disabled	Disabled OnBoard FDC.
Enabled	Enabled OnBoard FDC.

- **OnBoard Serial Port 1**

Auto	BIOS will automatically setup the port 1 address. <b>(Default Value)</b>
3F8/COM1	Enable onBoard Serial port 1 and address to 3F8.
2F8/COM2	Enable onBoard Serial port 1 and address to 2F8.
3E8/COM3	Enable onBoard Serial port 1 and address to 3E8.
2E8/COM4	Enable onBoard Serial port 1 and address to 2E8.
Disabled	Disable onBoard Serial port 1.

- **OnBoard Serial Port 2**

Auto	BIOS will automatically setup the port 2 address. <b>(Default Value)</b>
3F8/COM1	Enable onBoard Serial port 2 and address to 3F8.
2F8/COM2	Enable onBoard Serial port 2 and address to 2F8.
3E8/COM3	Enable onBoard Serial port 2 and address to 3E8.
2E8/COM4	Enable onBoard Serial port 2 and address to 2E8.
Disabled	Disable onBoard Serial port 2.

- **Serial Port 2 Mode**

(This item allows you to determine which Serial Port 2 Mode of onboard I/O chip)

ASK IR	Set onboard I/O chip Serial Port 2 to ASK IR Mode.
IrDA	Set onboard I/O chip Serial Port 2 to IrDA Mode.
Normal	Set onboard I/O chip Serial Port 2 to Normal Mode. <b>(Default Value)</b>

- **Duplex Mode**

Half Duplex	Half Duplex IR function.
N/A	Disabled this function. <b>(Default Value)</b>
Full Duplex	Full Duplex IR function.

- **OnBoard Parallel port**

378	Enable On Board LPT port and address to 378.
278	Enable On Board LPT port and address to 278.
3BC	Enable On Board LPT port and address to 3BC.
Auto	Set On Board LPT port to Auto. <b>(Default Value)</b>
Disabled	Disable On Board LPT port.

- **Parallel Port Mode**

EPP	Using Parallel port as Enhanced Parallel Port.
ECP	Using Parallel port as Extended Capabilities Port. <b>(Default Value)</b>
Normal	Normal Operation.

- **Parallel Port DMA**

Auto	Set Auto to parallel port mode DMA Channel. <b>(Default Value)</b>
3	Set Parallel Port DMA to 3.
1	Set Parallel Port DMA to 1.
0	Set Parallel Port DMA to 0.

- **Parallel Port IRQ**

7	Set Parallel Port IRQ to 7.
Auto	Set Auto to parallel Port IRQ DMA Channel. <b>(Default Value)</b>
5	Set Parallel Port IRQ to 5.

- **OnBoard Legacy Audio**

Enabled	Enabled OnBoard Legacy Audio. <b>(Default Value)</b>
Disabled	Disabled OnBoard Legacy Audio.

- **Sound Blaster**

Enabled	Enabled Sound Blaster.
Disabled	Disabled Sound Blaster. <b>(Default Value)</b>

- **SB I/O Base Address**

220h-22Fh	Set SB I/O Base Address to 220h-22Fh. <b>(Default Value)</b>
280h-28Fh	Set SB I/O Base Address to 280h-28Fh.
260h-26Fh	Set SB I/O Base Address to 260h-26Fh.
240h-24Fh	Set SB I/O Base Address to 240h-24Fh.

- **SB IRQ Select**

IRQ 5 / 7 / 9 / 10. <b>(Default Value: 5)</b>
---

- **SB DMA Select**

DMA 0 / 1 / 2 / 3. <b>(Default Value: 1)</b>
--

- **MPU-401**

Enabled	Enabled MPU-401.
Disabled	Disabled MPU-401. <b>(Default Value)</b>

Ps. When Force Feedback joystick is used, MPU-401 needs to be Enable.

- **MPU-401 I/O Address**

330h-333h	Set MPU-401 I/O Address to 330h-333h. <b>(Default Value)</b>
300h-303h	Set MPU-401 I/O Address to 300h-303h.
310h-313h	Set MPU-401 I/O Address to 310h-313h.
320h-323h	Set MPU-401 I/O Address to 320h-323h.

- **FM Port (388h-38Bh)**

Disabled	Disabled FM Port (388h-38Bh). <b>(Default Value)</b>
Enabled	Enabled FM Port (388h-38Bh).

- **Game Port (200h-207h)**

Disabled	Disabled Game Port (200h-207h).
Enabled	Enabled Game Port (200h-207h). <b>(Default Value)</b>

- **Onboard Midi In/Out**

Please enabled midi port when you use Force Feedback Joystick/general Midi device.

Enabled	Enabled Onboard Midi In/Out function.
Disabled	Disabled this function. <b>(Default Value)</b>

## Hardware Monitor

AMIBIOS SETUP –HARDWARE MONITOR	
(C) 1999 American Megatrends, Inc. All Rights Reserved	
ACPI Shut Down Temp.	:Disabled
Current CPU1 Temp.	:36°C/96°F
Current CPU2 Temp.	:28°C/82°F
Current System Temp.	:30°C/86°F
Current CPU1 Fan Speed	:5487 RPM
Current CPU2 Fan Speed	:0 RPM
Vcc2P	:1.637V
Vcc2S	:1.625V
+3.300V	:3.191V
+5.000V	:4.971V
+12.000V	:11.866V
ESC : Quit            ↑↓←→: Select Item F1 : Help            PU/PD/+/- : Modify F5 : Old Values    (Shift)F2 :Color F6 : Load BIOS Defaults F7 : Load Setup Defaults	

Figure 10: Hardware Monitor

- **ACPI Shutdown Temp. (°C / °F)**

(This function will be effective only for the operating systems that support ACPI Function.)

Disabled	Disabled ACPI Shutdown function. <b>(Default Value)</b>
60°C / 140°F	Monitor CPU Temp. at 60°C / 140°F, if Temp. > 60°C / 140°F system will automatically power off.
70°C / 158°F	Monitor CPU Temp. at 70°C / 158°F, if Temp. > 70°C / 158°F system will automatically power off.
80°C / 176°F	Monitor CPU Temp. at 80°C / 176°F, if Temp. > 80°C / 176°F system will automatically power off.
90°C / 194°F	Monitor CPU Temp. at 90°C / 194°F, if Temp. > 90°C / 194°F system will automatically power off.

- **Current CPU1 Temp. (°C / °F)**  
Detect CPU1 Temperature automatically.
- **Current CPU2 Temp. (°C / °F)**  
Detect CPU2 Temperature automatically.
- **Current System Temp. (°C / °F)**  
Detect System Temperature automatically.
- **Current CPU1 Fan Speed**  
Detect CPU1 Fan speed status automatically.
- **Current CPU2 Fan Speed**  
Detect CPU2 Fan speed status automatically.
- **Current Voltage (V) Vcc2P/Vcc2S/+3.3V/+5V/+12V**  
Detect system's voltage status automatically.

## Set Supervisor / User Password

When you select this function, the following message will appear at the center of the screen to assist you in creating a password.

AMIBIOS SIMPLE SETUP UTILITY-VERSION 1.22 ( C ) 1999 American Megatrends, Inc. All Rights Reserved	
STANDARD CMOS SETUP	INTEGRATED PERIPHERALS
BIOS FEATURES SETUP	HARDWARE MONITOR SETUP
CHIPSET FEATURES SETUP	SUPERVISOR PASSWORD
POWER MANA	Enter new supervisor password:
PNP/PCI CONF	
LOAD BIOS DEFAULTS	SAVE & EXIT SETUP
LOAD SETUP DEFAULTS	EXIT WITHOUT SAVING
ESC : Quit    ↑↓→← : Select Item    (Shift) F2 : Change Color    F5 : Old Values F6 : Load BIOS Defaults    F7: Load Setup Defaults    F10: Save & Exit	
Chang /Set /Disabled Password	

Figure 11: Password Setting

Type the password, up to eight characters, and press <Enter>. The password typed now will clear the previously entered password from CMOS memory. You will be asked to confirm the password. Type the password again and press <Enter>. You may also press <Esc> to abort the selection and not enter a password.

To disable password, just press <Enter> when you are prompted to enter password. A message "PASSWORD DISABLED" will appear to confirm the password being disabled. Once the password is disabled, the system will boot and you can enter Setup freely.

If you select "Always" at "Password Check" Option in BIOS Features Setup Menu, you will be prompted for the password every time the system is rebooted or any time you try to enter Setup Menu. If you select "Setup" at "Password Check" Option in BIOS Features Setup Menu, you will be prompted only when you try to enter Setup.

## IDE HDD AUTO Detection

AMIBIOS SETUP – STANDARD CMOS SETUP							
( C ) 1999 American Megatrends, Inc. All Rights Reserved							
Date (mm/dd/yyyy) : Tue Feb 17, 2000							
Time (hh/mm/ss) : 10:36:24							
TYPE	SIZE	CYLS	HEAD	PRECOMP	LANDZ	SECTOR	MODE
Pri Master :Not Installed							
Pri Slave :Not Installed							
Sec Master :Not Installed							
Sec Slave :Not Installed							
Floppy Drive A: 1.44 MB 3 ½				Base Memory : 640 Kb			
Floppy Drive B: Not Installed				Other Memory : 384 Kb			
Boot Sector Virus Protection : Disabled				Extended Memory : 31Mb			
				Total Memory : 32Mb			
Month: Jan – Dec				ESC : Exit			
Day: 01 – 31				↑↓ : Select Item			
Year : 1990 – 2099				PU/PD/+/- : Modify			
				Shift)F2 : Color			

Figure 12: IDE HDD Auto Detection

Type "Y" will accept the H.D.D. parameter reported by BIOS.

Type "N" will keep the old H.D.D. parameter setup. If the hard disk cylinder number is over 1024, then the user can select LBA mode or LARGER mode for DOS partition larger than 528 MB.

## Save & Exit Setup

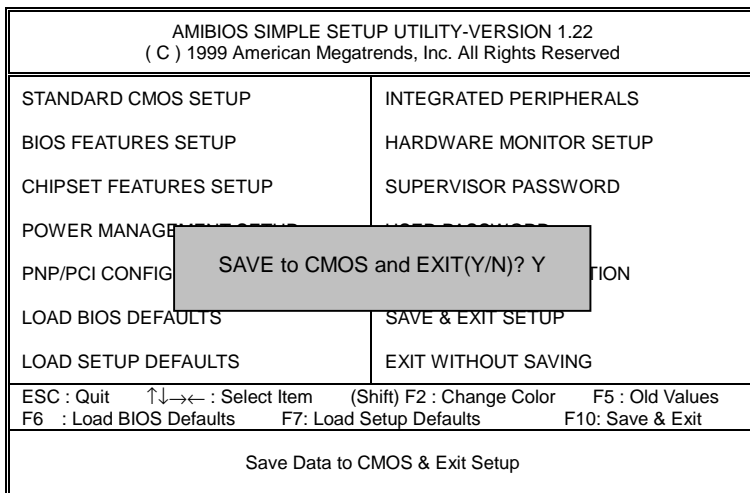

Figure 13: Save & Exit Setup

Type "Y" will quit the Setup Utility and save the user setup value to RTC CMOS.

Type "N" will return to Setup Utility.

## Exit Without Saving

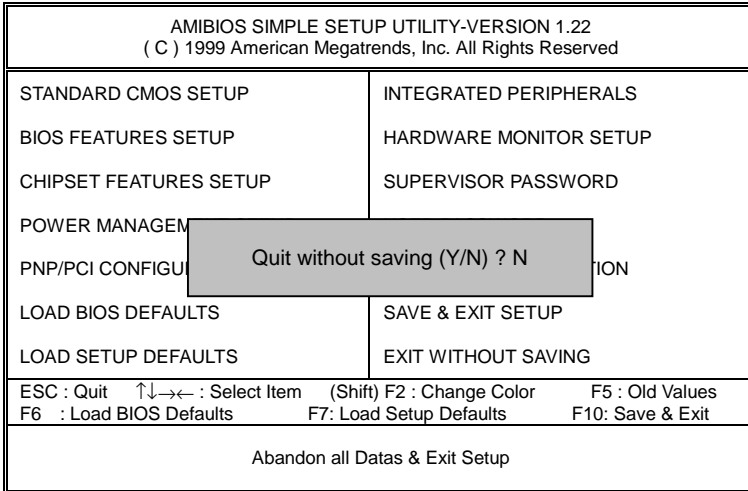

Figure 14: Exit Without Saving

Type "Y" will quit the Setup Utility without saving to RTC CMOS.

Type "N" will return to Setup Utility.

# Appendix

## Appendix A: VIA Chipsets Driver

### A. VIA 4 in 1 Service Pack Utility:

Insert the support CD that came with your motherboard into your CD-ROM driver or double-click the CD driver icon in My Computer to bring up the screen.

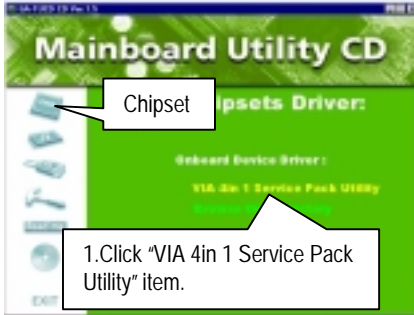

(1)

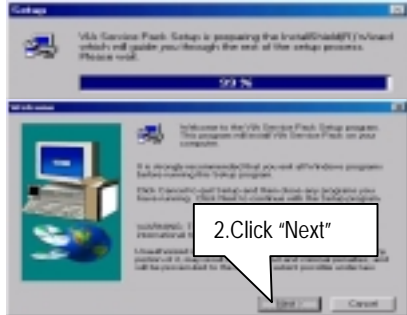

(2)

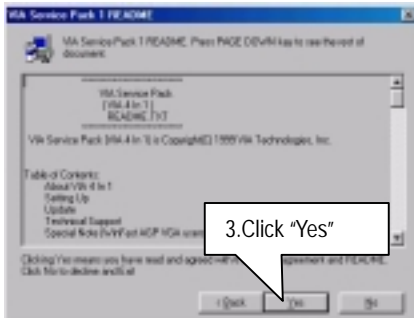

(3)

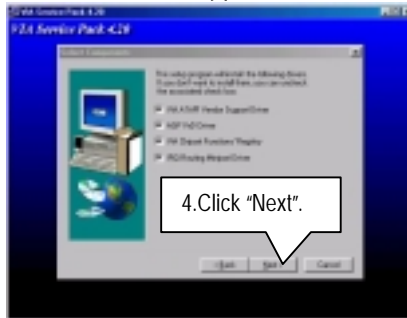

(4)

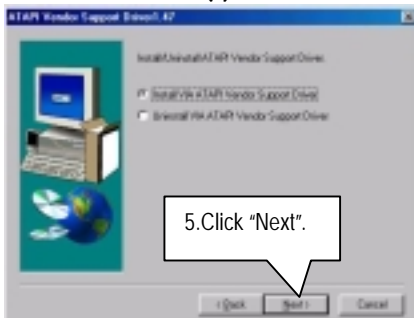

(5)

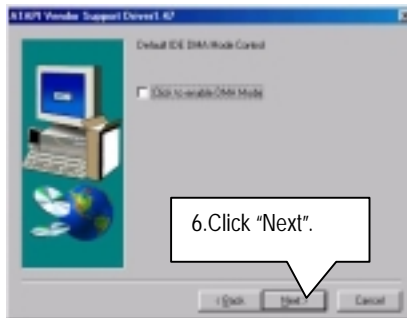

(6)

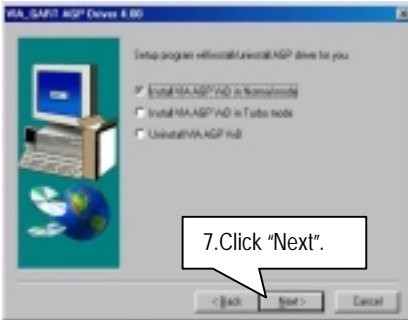

(7)

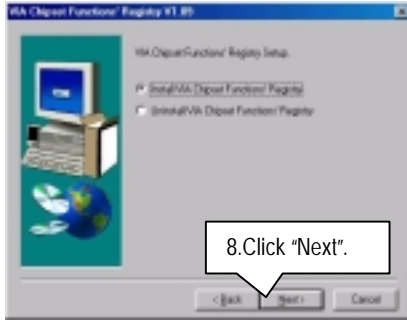

(8)

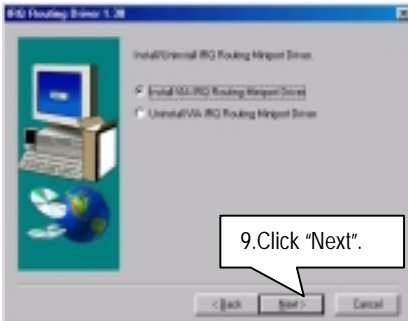

(9)

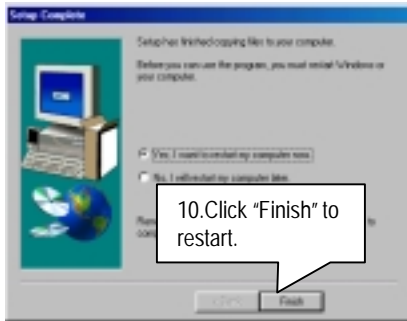

(10)

## Appendix B: Creative Sound Driver Installation (Optional)

Insert the support CD that came with your motherboard into your CD-ROM driver or double-click the CD driver icon in My Computer to bring up the screen.

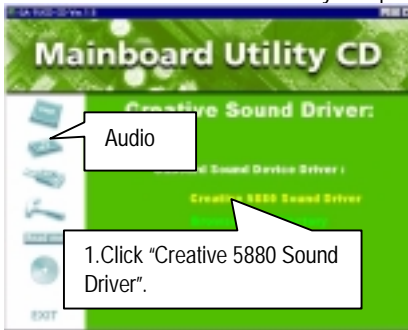

(1)

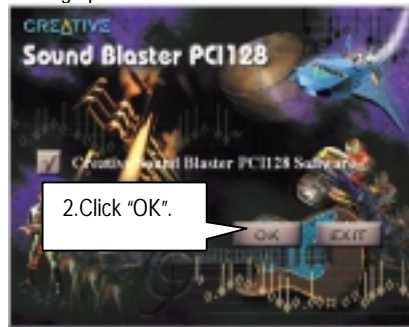

(2)

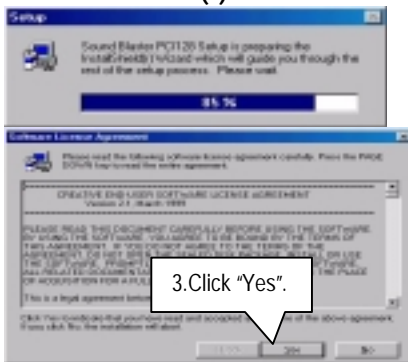

(3)

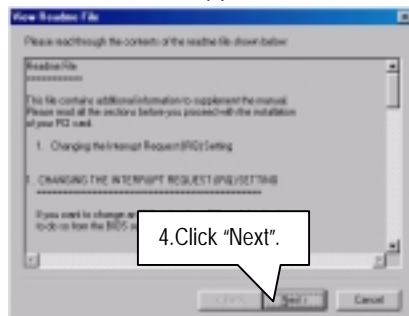

(4)

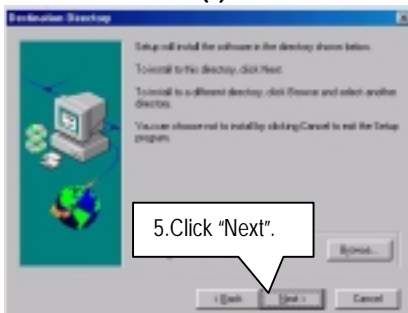

(5)

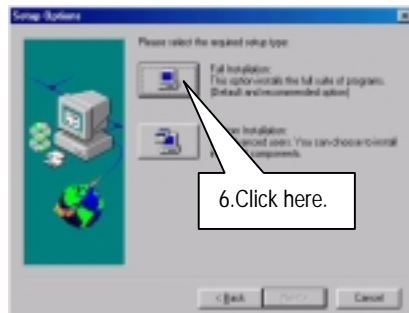

(6)



(7)

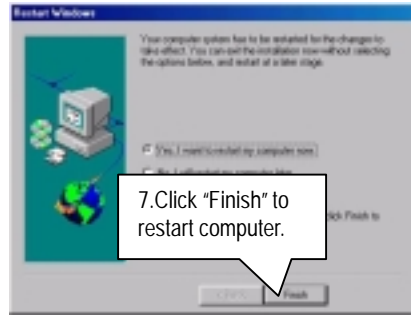

(8)

## Appendix C: VIA Sound Driver (Optional)

### A. AC'97 Audio Driver:

Insert the support CD that came with your motherboard into your CD-ROM driver or double-click the CD driver icon in My Computer to bring up the screen.

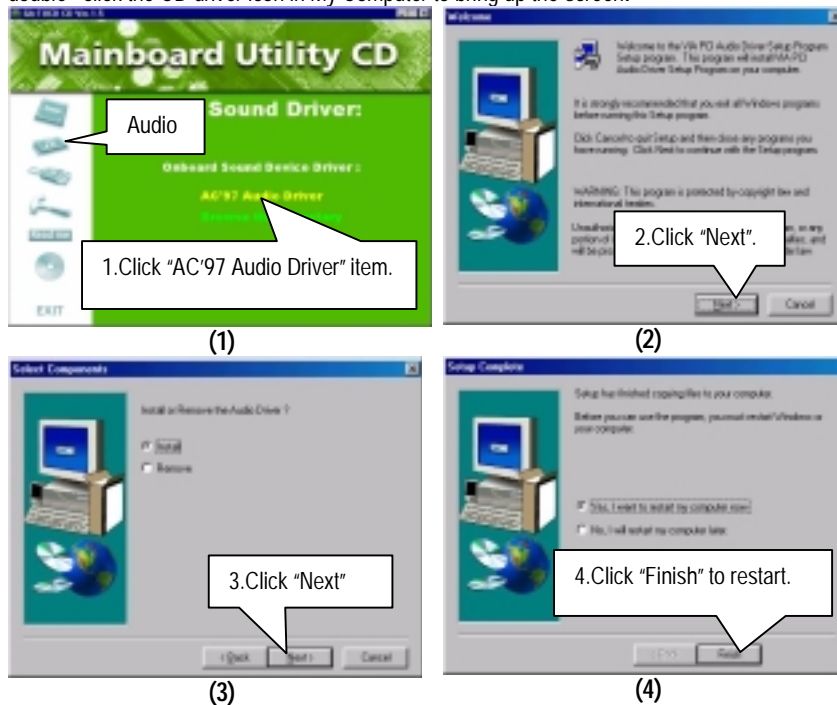

---

## Appendix D: BIOS Flash Procedure

BIOS update procedure:

- ✓ Please check your BIOS vendor (AMI or AWARD) on the motherboard.
  - ✓ It is recommended you copy the AWDFlash.exe or AMIFlash.exe in driver CD (D:\>Utility\BIOSFlash) and the BIOS binary files into the directory you made in your hard disk. 【 i.e:C:\>Utility\ (C:\>Utility : denotes the driver and the directory where you put the flash utilities and BIOS file in.) 】
  - ✓ Restart your computer into MS-DOS mode or command prompt only for Win95/98, go into the directory where the new BIOS file are located use the utility AWDFlash.exe or AMIFlash.exe to update the BIOS.
  - ✓ Type the following command once you have enter the directory where all the files are located C:\utility\ AWDFlash or AMIFlash <filename of the BIOS binary file intended for flashing>
  - ✓ Once the process is finished, reboot the system
- <sup>ⓘ</sup>Note: Please download the newest BIOS from our website ([www.gigabyte.com.tw](http://www.gigabyte.com.tw)) or contact your local dealer for the file.

## Appendix E: Acronyms

Acor.	Meaning
ACPI	Advanced Configuration and Power Interface
POST	Power-On Self Test
LAN	Local Area Network
ECP	Extended Capabilities Port
APM	Advanced Power Management
DMA	Direct Memory Access
MHz	Megahertz
ESCD	Extended System Configuration Data
CPU	Central Processing Unit
SMP	Symmetric Multi-Processing
USB	Universal Serial Bus
OS	Operating System
ECC	Error Checking and Correcting
IDE	Integrated Dual Channel Enhanced
SCI	Special Circumstance Instructions
LBA	Logical Block Addressing
EMC	Electromagnetic Compatibility
BIOS	Basic Input / Output System
SMI	System Management Interrupt
IRQ	Interrupt Request
NIC	Network Interface Card
A.G.P.	Accelerated Graphics Port
S.E.C.C.	Single Edge Contact Cartridge
LED	Light Emitting Diode
EPP	Enhanced Parallel Port
CMOS	Complementary Metal Oxide Semiconductor
I/O	Input / Output
ESD	Electrostatic Discharge
OEM	Original Equipment Manufacturer
SRAM	Static Random Access Memory
VID	Voltage ID
DMI	Desktop Management Interface
MIDI	Musical Interface Digital Interface
IOAPIC	Input Output Advanced Programmable Interrupt Controller
DIMM	Dual Inline Memory Module
DRAM	Dynamic Random Access Memory
PAC	PCI A.G.P. Controller
AMR	Audio Modem Riser

To be continued...

---

Acor.	Meaning
PCI	Peripheral Component Interconnect
RIMM	Rambus in-line Memory Module
DRM	Dual Retention Mechanism
ISA	Industry Standard Architecture
MTH	Memory Translator Hub
CRIMM	Continuity RIMM