

original Poke-Home[®] d-sub 17 series

WPI original poke-home blocks can accept the wide range of contact types described on this page.

Poke Home[®] d-sub connectors

A removable contact type connector that meets most commercial requirements. The connector is available with crimp type contacts, solder type, and printed circuit types in both .023 and .040 inch diameter pintails. The .040 pintail is available in two lengths or with right angles.



Standard crimp type contacts

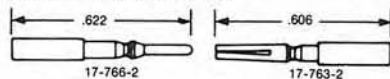

Standard solder type contacts

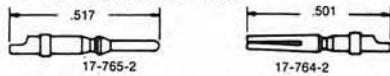

Pintail contacts for P.C. mounting

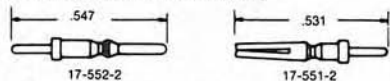

Right angle .040 dia. pintails.

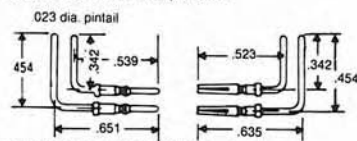

17-1198-2 (short), 17-1207-2 (long), pin
17-1208-2 (short), 17-1209-2 (long) socket

Optional contacts



Over-size crimp barrel contacts for 16 ga. wire

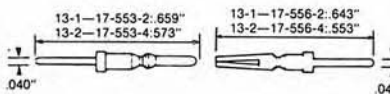

specifications

Temperature ranges:
-67° F (-55° C) to
+257° F (+125° C)
Current rating: 7.5 A
Voltage rating:
500 VAC (RMS) at sea level
150 VAC (RMS) at 90,000 feet
Dielectric: Zytel 101
nylon per Mil M-20693

Shells: Steel clear chromated over zinc.
Gold iridite finish available on
request per QQP416A Type II
Contacts: Crimp - gold over nickel plated
copper alloy
Solder - gold over nickel plated copper
alloy
Wire size: Solder: up to #20
Crimp #20, #22, and #24AWG

contact arrangements

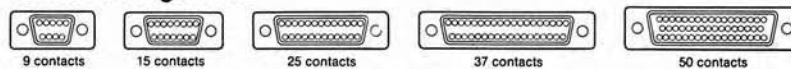

Number of Contacts	Receptacle	Receptacle with Float Bushings	Plug
9	17-300-1	17-785	17-301-1
15	17-302-1	17-793	17-303-1
25	17-304-1	17-789	17-305-1
37	17-306-1	17-797	17-307-1
50	17-308-1	17-1001	17-309-1

Connectors above have zinc plated clear chromate steel shells. For gold-iridite finish, add one number to suffix. Examples: 17-300-2, 17-786. See page 5 for optional bright tin.

Number of Contacts	Crimp Type Includes specified number of standard crimp contacts		Solder Type Includes specified number of standard solder contacts	
	Receptacle Socket Contacts	Plug Pin Contacts	Receptacle Socket Contacts	Plug Pin Contacts
9	17-10090-1	17-20090-1	17-10090	17-20090
15	17-10150-1	17-20150-1	17-10150	17-20150
25	17-10250-1	17-20250-1	17-10250	17-20250
37	17-10370-1	17-20370-1	17-10370	17-20370
50	17-10500-1	17-20500-1	17-10500	17-20500

Number of Contacts	PC Board Type Includes specified number of pintail contacts inserted in place			
	Receptacle With 17-551-02 Socket Contacts	Plug With 17-552-02 Pin Contacts	Receptacle With 17-556-XX Socket Contacts	Plug With 17-553-XX Pin Contacts
9	17-10090-11	17-20090-11	17-10090-13-XX	17-20090-13-XX
15	17-10150-11	17-20150-11	17-10150-13-XX	17-20150-13-XX
25	17-10250-11	17-20250-11	17-10250-13-XX	17-20250-13-XX
37	17-10370-11	17-20370-11	17-10370-13-XX	17-20370-13-XX
50	17-10500-11	17-20500-11	17-10500-13-XX	17-20500-13-XX

Connectors can also be ordered without contacts for use with bulk packed contacts in semi-automatic crimping machines. Contact sales office nearest you.

EMI/ESD accommodation

All shells on housings can be supplied with bright tin finish and grounding indents on plug front shells to accommodate grounding. Metal and plated plastic hoods and clamps are also available in many sizes to shield exposed terminations.

order information housings

17-30X-3 for bright tin - receptables only
17-30X-3 (439) for bright tin and grounding indents - plugs only

assembled connectors

17-12XXX-XX (receptacle) for bright tin
17-22XXX-XX (439) (plugs) for bright tin with grounding indents

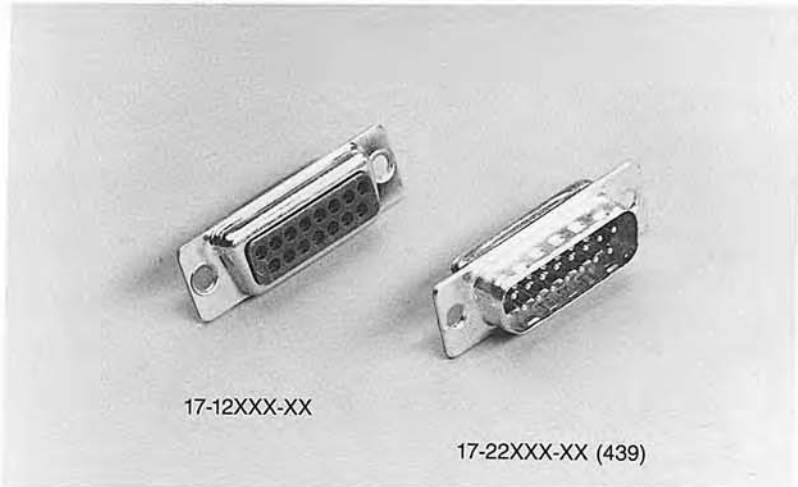



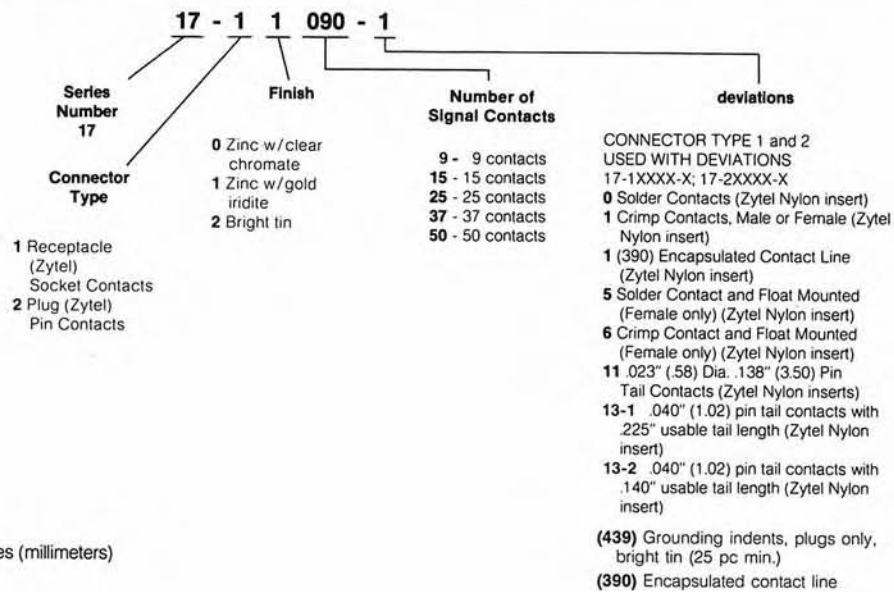



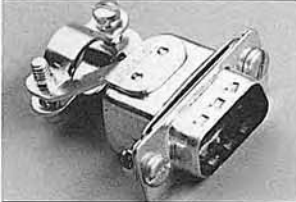

order information

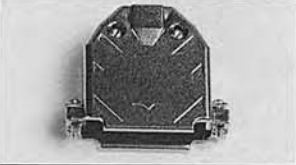

All dimensions: inches (millimeters)

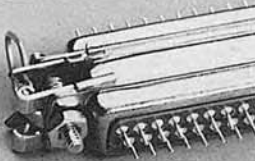
WPI® d-subminiature accessories quick reference chart

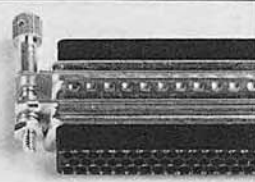
Accessories	Page	Shell size Configuration	E 9	A 15	B 25	C 37	D 50	
	8	Metallic straight cable housing with cable clamp	clear finish	17-310-1	17-311-1	17-312-1	17-313-1	17-314-1
			Gold iridite	17-310-2	17-311-2	17-312-2	17-313-2	17-314-2
	8	2 piece screw lock back shells with cable clamp (side or top cable entry)	17-1370	17-1371	17-1372	17-1373	17-1374	
	9	Two piece plastic (UL) housing with cable clamp. (side or top cable entry)	with standard screw	17-1587-6	17-1588-6	17-1589-6	17-1590-6	17-1591-6
			with long jack screw	17-1587-9	17-1588-9	17-1589-9	17-1590-9	17-1591-9
	9	Die cast metal two-piece back shells - screw lock with internal cable clamp - top entry	17-1657-9	17-1657-15	17-1657-25	17-1657-37	17-1657-50	
	10	Plastic two piece back shells - screw lock with internal cable clamp - top entry	17-1724-1	17-1725-1	17-1726-1	17-1727-1	17-1728-1	
	10	Metalized plastic two piece back shells - screw lock with internal cable clamp - top entry	17-1724-2	17-1725-2	17-1726-2	17-1727-2	17-1728-2	

Accessories	Page	Shell size Configuration	E 9	A 15	B 25	C 37	D 50	
	11	Spring Latch	clear finish	17-529	17-529	17-529	17-529	17-770
			Gold iridite	17-847	17-847	17-847	17-847	17-850
	11	Screw Lock Assembly	17-768	17-768	17-768	17-768	17-769	
	11	Jack Socket	17-893	17-893	17-893	17-893	17-893	
		Jack Screw	17-894	17-894	17-894	17-894	17-894	
		Jack Assembly	17-895	17-895	17-895	17-895	17-895	
	Sec. 15 Pg. 2	D-type RS232 connector field service kit	17RR-232K					

d-subminiature accessories

cable clamp assembly

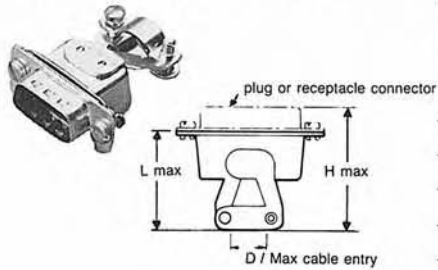

Shell size	Order No.		D	H	L
	clear chromate finish	gold iridite finish			
E	17-310-1	17-310-2	.406(10.30)	1.358(34.50)	1.094(27.80)
A	17-311-1	17-311-2	.406(10.30)	1.358(34.50)	1.094(27.80)
B	17-312-1	17-312-2	.594(15.10)	1.390(35.30)	1.126(28.60)
C	17-313-1	17-313-2	.720(18.30)	1.390(35.30)	1.126(28.60)
D	17-314-1	17-314-2	.720(18.30)	1.390(35.30)	1.126(28.60)

hoods with external clamps

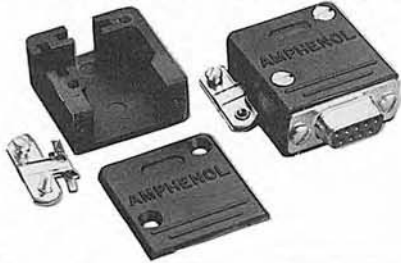

CABLE CLAMP CONFIGURATION FOR SIZES 9, 15 AND 25

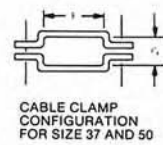
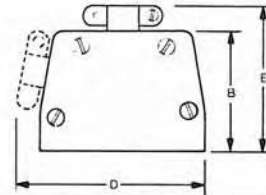
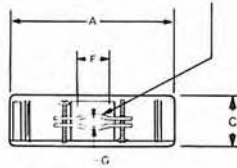

Shell Size	Order No.	Dimensions						
		A Max.	B	C Max.	D Max.	E Max.	F Max.	G Max.
E	17-1370	1.240(31.50)	1.291(32.80)	.661(16.80)	1.559(39.60)	1.638(41.60)	.252(6.40)	.181(4.60)
A	17-1371	1.567(39.80)	1.500(38.10)	.661(16.80)	1.886(47.90)	1.846(46.90)	.374(9.50)	.220(5.60)
B	17-1372	2.110(53.60)	1.500(38.10)	.661(16.80)	2.433(61.80)	1.350(47.00)	.449(11.40)	.299(7.60)
C	17-1373	2.756(70.00)	1.594(40.50)	.661(16.80)	3.272(83.10)	2.134(54.20)	.650(16.50)	.358(9.10)
D	17-1374	2.634(50.00)	1.594(40.50)	.780(19.80)	3.177(80.70)	2.134(54.20)	.650(16.50)	.461(11.70)

hoods with internal cable clamps

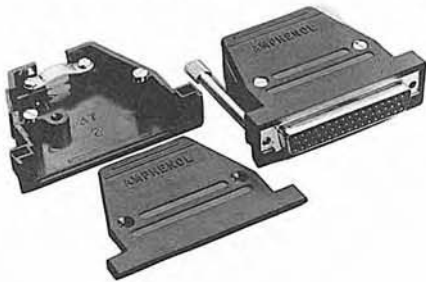

(9 and 15 contact only)

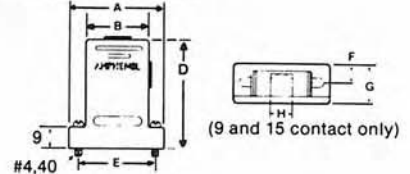

(25, 37 and 50 contacts)

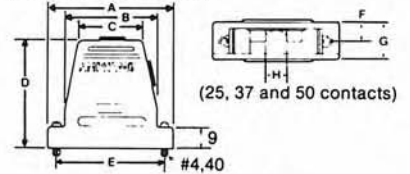

Shell Size	Order No. Standard Screw	Order No. Long Jack Screw	A	B	C	D	E	F	G	H
E	17-1587-6	17-1587-9	1.358(34.5)	.760(19.3)	—	1.610(40.9)	.984(25.0)	.321(8.15)	.642(16.3)	.374(6.4)
A	17-1588-6	17-1588-9	1.689(42.9)	1.087(27.6)	—	1.890(48.0)	1.311(33.3)	.321(8.15)	.642(16.3)	.374(9.5)
B	17-1589-6	17-1589-9	2.228(56.6)	1.626(41.3)	1.230(32.5)	1.890(48.0)	1.850(47.0)	.312(8.15)	.252(16.3)	.374(9.5)
C	17-1590-6	17-1590-9	2.874(73.0)	2.222(57.7)	1.402(35.6)	2.091(53.1)	2.500(63.5)	.321(8.15)	.252(16.3)	.531(13.5)
D	17-1591-6	17-1591-9	2.280(70.6)	2.181(55.4)	1.567(39.8)	2.091(53.1)	2.406(61.1)	.380(9.65)	.760(19.3)	.531(13.5)

die cast two piece backshell

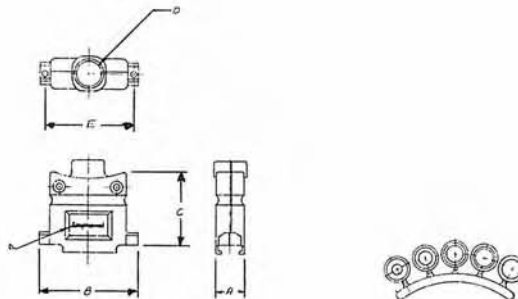
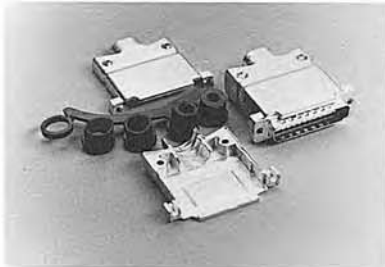

screw lock with
internal cable clamp
- top entry

Shell Size	Order No.	A	B	C	D	E	Cable Dia. Min/Max
E	17-1657-9	.620(15.75)	1.225(31.12)	1.465(37.21)	.400(10.16)	.984(25.00)	.190/.350(4.83/8.89)
A	17-1657-15	.620(15.75)	1.540(39.12)	1.600(40.64)	.400(10.16)	1.312(33.32)	.190/.350(4.83/8.89)
B	16-1657-25	.620(15.75)	2.090(53.09)	1.550(39.37)	.525(13.34)	1.857(47.17)	.190/.460(4.83/11.68)
C	17-1657-37	.620(15.75)	2.750(69.85)	1.800(45.72)	.725(18.42)	2.500(63.50)	.300/.680(7.62/17.27)
D	17-1657-50	.730(18.54)	2.645(67.18)	1.800(45.72)	.725(18.42)	2.406(61.11)	.300/.680(7.62/17.27)

plastic two piece backshell

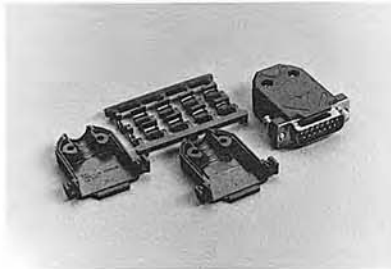

screw lock with
internal cable clamp
- top entry

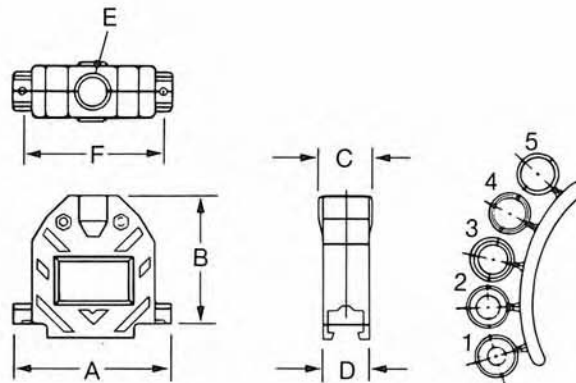

Shell Size	Order No.	A	B	C	D	E	F	Cable Dia. Min/Max
E	17-1724-1	1.225(31.12)	1.397(35.48)	.640(16.26)	.640(16.26)	.400(10.16)	.984(25.00)	.190/.350(4.83/8.89)
A	17-1725-1	1.540(39.12)	1.526(38.76)	.640(16.26)	.640(16.26)	.400(10.16)	1.312(33.32)	.190/.350(4.83/8.89)
B	17-1726-1	2.090(53.09)	1.655(42.04)	.710(18.03)	.640(16.26)	.522(13.26)	1.857(47.17)	.190/.460(4.83/11.68)
C	17-1727-1	2.730(69.34)	1.850(47.00)	.920(23.37)	.640(16.26)	.725(18.42)	2.500(63.50)	.300/.680(7.62/17.27)
D	17-1728-1	2.645(67.18)	1.717(43.61)	.882(22.40)	.750(19.05)	.725(18.42)	2.406(61.11)	.300/.680(7.62/17.27)

metalized plastic two piece backshell

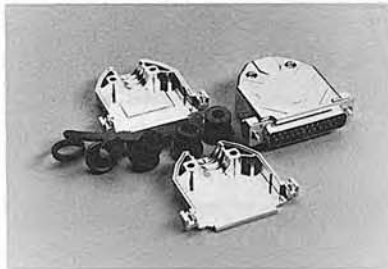

screw lock with
internal cable clamp
- top entry

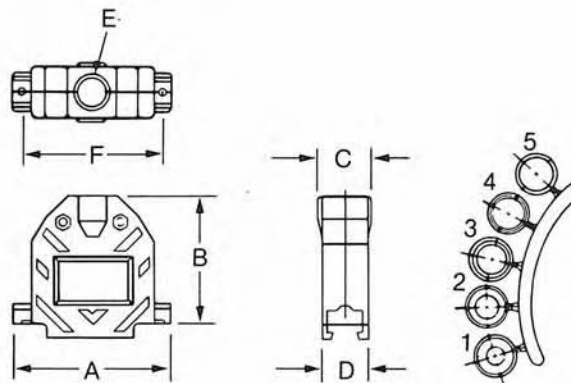

Shell Size	Order No.	A	B	C	D	E	F	Cable Dia. Min/Max
E	17-1724-2	1.225(31.12)	1.397(35.48)	.640(16.26)	.640(16.26)	.400(10.16)	.984(25.00)	.190/.350(4.83/8.89)
A	17-1725-2	1.540(39.12)	1.526(38.76)	.640(16.26)	.640(16.26)	.400(10.16)	1.312(33.32)	.190/.350(4.83/8.89)
B	17-1726-2	2.090(53.09)	1.655(42.04)	.710(18.03)	.640(16.26)	.522(13.26)	1.857(47.17)	.190/.460(4.83/11.68)
C	17-1727-2	2.730(69.34)	1.850(47.00)	.920(23.37)	.640(16.26)	.725(18.42)	2.500(63.50)	.300/.680(7.62/17.27)
D	17-1728-2	2.645(67.18)	1.717(43.61)	.882(22.40)	.750(19.05)	.725(18.42)	2.406(61.11)	.300/.680(7.62/17.27)

spring latch

Material:
Steel clear chromate finish or gold
iridite finish each order no. includes
2 of each style

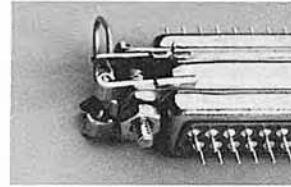
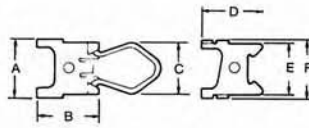

Size	Order No.:		A	B	C	D	E	F
	clear	gold						
E,A,B,C	17-529	17-847	.567(14.4)	.614(15.6)	.484(12.3)	.614(15.6)	.484(12.3)	.567(14.4)
D	17-770	17-850	.681(17.3)	.614(15.6)	.610(15.5)	.614(15.6)	.610(15.5)	.681(17.3)

All dimensions: inches (millimeters)

screw lock assembly - provides positive locking

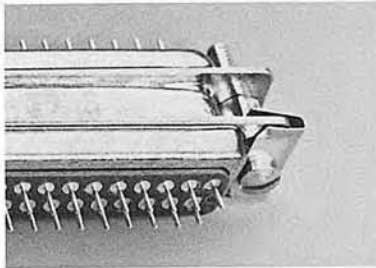

Stainless steel passivated

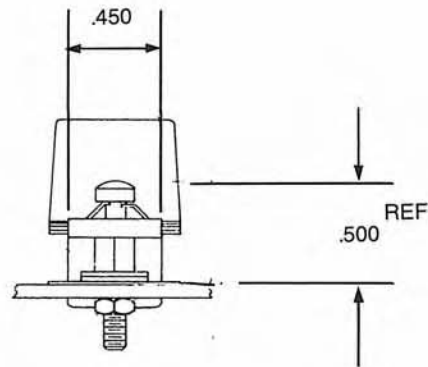

Shell Size	Order No.
E, A, B C & D	17-768

screw type locking assemblies to WPI design

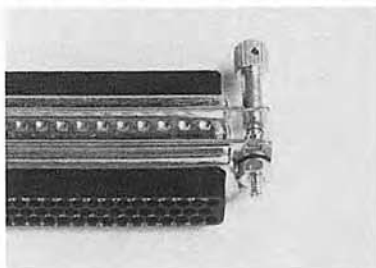

	Clear Chromate Finish
Jack Socket (includes 2 sockets, lock washers & nuts)	17-893
Jack Screw (includes 2 screws, washers & retaining rings)	17-894
Complete Assembly (includes both of above)	17-895

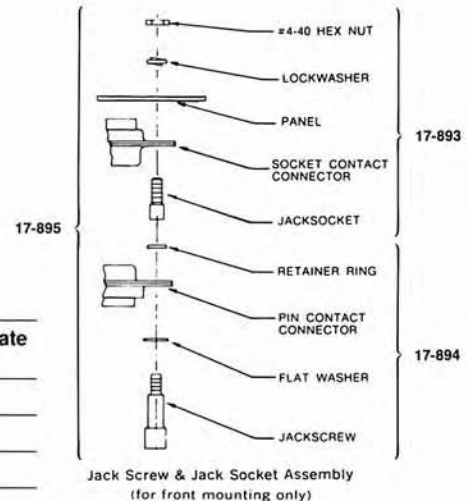

d-subminiature panel cutouts

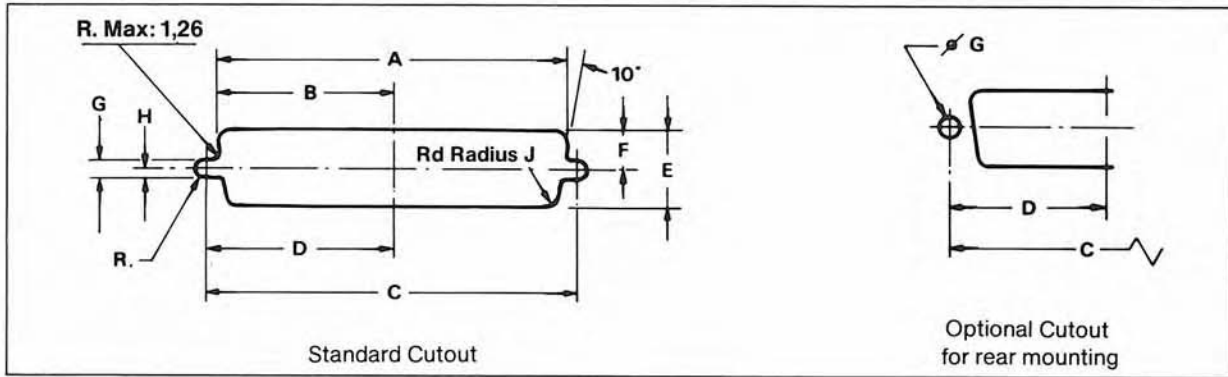
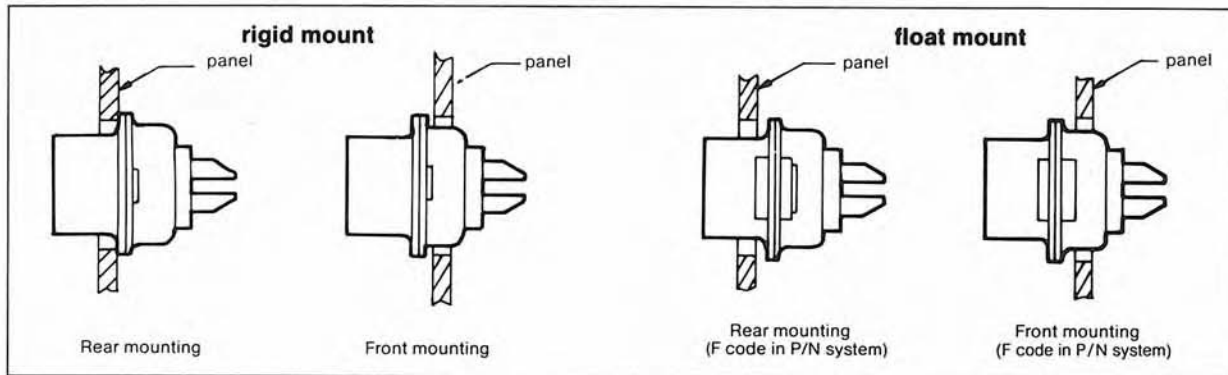

Config-uration	Mount type	Mounting Methode	A ± .008 (± 0.2)	B ± .008 (± 0.2)	C ± .008 (± 0.2)	D ± .008 (± 0.2)	E ± .008 (± 0.2)	F ± .008 (± 0.2)	G ± .004 (± 0.1)	H ± .004 (± 0.1)	J ± .008 (± 0.2)
9	rigid	Front	.874(22.2)	.437(11.1)	.984(25.0)	.492(12.5)	.512(13.0)	.256(6.5)	.118(3)	.059(1.5)	.083(2.1)
		Rear	.807(20.5)	.402(10.2)	.984(25.0)	.492(12.5)	.449(11.4)	.224(5.7)	.118(3)	.059(1.5)	.134(3.4)
	float	Front	.906(23.0)	.453(11.5)	.984(25.0)	.492(12.5)	.543(13.8)	.272(6.9)	.087(2.2)	.043(1.1)	.083(2.1)
		Rear	.839(21.3)	.417(10.6)	.984(25.0)	.492(12.5)	.441(11.2)	.240(6.1)	.087(2.2)	.043(1.1)	.134(3.4)
15	rigid	Front	1.201(30.5)	.602(15.3)	1.311(33.3)	.657(16.7)	.572(13.0)	.256(6.5)	.118(3)	.059(1.5)	.083(2.1)
		Rear	1.134(28.8)	.567(14.4)	1.311(33.3)	.657(16.7)	.449(11.4)	.224(5.7)	.118(3)	.059(1.5)	.134(3.4)
	float	Front	1.222(31.3)	.618(15.7)	1.311(33.3)	.657(16.7)	.543(13.8)	.272(6.9)	.087(2.2)	.043(1.1)	.083(2.1)
		Rear	1.165(29.6)	.583(14.8)	1.311(33.3)	.657(16.7)	.480(12.2)	.240(6.1)	.087(2.2)	.043(1.1)	.134(3.4)
25	rigid	Front	1.744(44.3)	.870(22.1)	1.850(47)	.925(23.5)	.512(13.0)	.256(6.5)	.118(3)	.059(1.5)	.083(2.1)
		Rear	1.673(42.5)	.839(21.3)	1.850(47)	.925(23.5)	.449(11.4)	.224(5.7)	.118(3)	.059(1.5)	.134(3.4)
	float	Front	1.776(45.1)	.890(22.6)	1.850(47)	.925(23.5)	.543(13.8)	.272(6.9)	.087(2.2)	.043(1.1)	.083(2.1)
		Rear	1.705(43.3)	.854(21.7)	1.850(47)	.925(23.5)	.480(12.2)	.240(6.1)	.087(2.2)	.043(1.1)	.134(3.4)
37	rigid	Front	2.890(60.7)	1.197(30.4)	2.500(63.5)	1.248(31.7)	.512(13.0)	.256(6.5)	.118(3)	.059(1.5)	.083(2.1)
		Rear	2.327(59.1)	1.161(29.5)	2.500(63.5)	1.248(31.7)	.449(11.4)	.224(5.7)	.118(3)	.059(1.5)	.134(3.4)
	float	Front	2.421(61.5)	1.213(30.8)	2.500(63.5)	1.248(31.7)	.543(13.8)	.272(6.9)	.087(2.2)	.043(1.1)	.083(2.1)
		Rear	2.354(59.8)	1.177(29.9)	2.500(63.5)	1.248(31.7)	.480(12.2)	.240(6.1)	.087(2.2)	.043(1.1)	.134(3.4)
50	rigid	Front	2.295(58.3)	1.150(29.2)	2.406(61.1)	1.205(30.6)	.622(15.8)	.311(7.9)	.118(3)	.059(1.5)	.083(2.1)
		Rear	2.217(56.3)	1.110(28.2)	2.406(61.1)	1.205(30.6)	.555(14.1)	.280(7.1)	.118(3)	.059(1.5)	.134(3.4)
	float	Front	2.331(59.2)	1.165(29.6)	2.406(61.1)	1.205(30.6)	.654(16.6)	.327(8.3)	.087(2.2)	.043(1.1)	.083(2.1)
		Rear	2.248(57.1)	1.126(28.6)	2.406(61.1)	1.205(30.6)	.587(14.9)	.295(7.5)	.087(2.2)	.043(1.1)	.134(3.4)

All dimensions: inches (millimeters)

d-subminiature panel mounting

A, B, C and H are dimensions between panels and represent the recommended limit to be used in the design of the

connector mounting method. It is recommended that only one assembly either pin or socket, be float mounted.

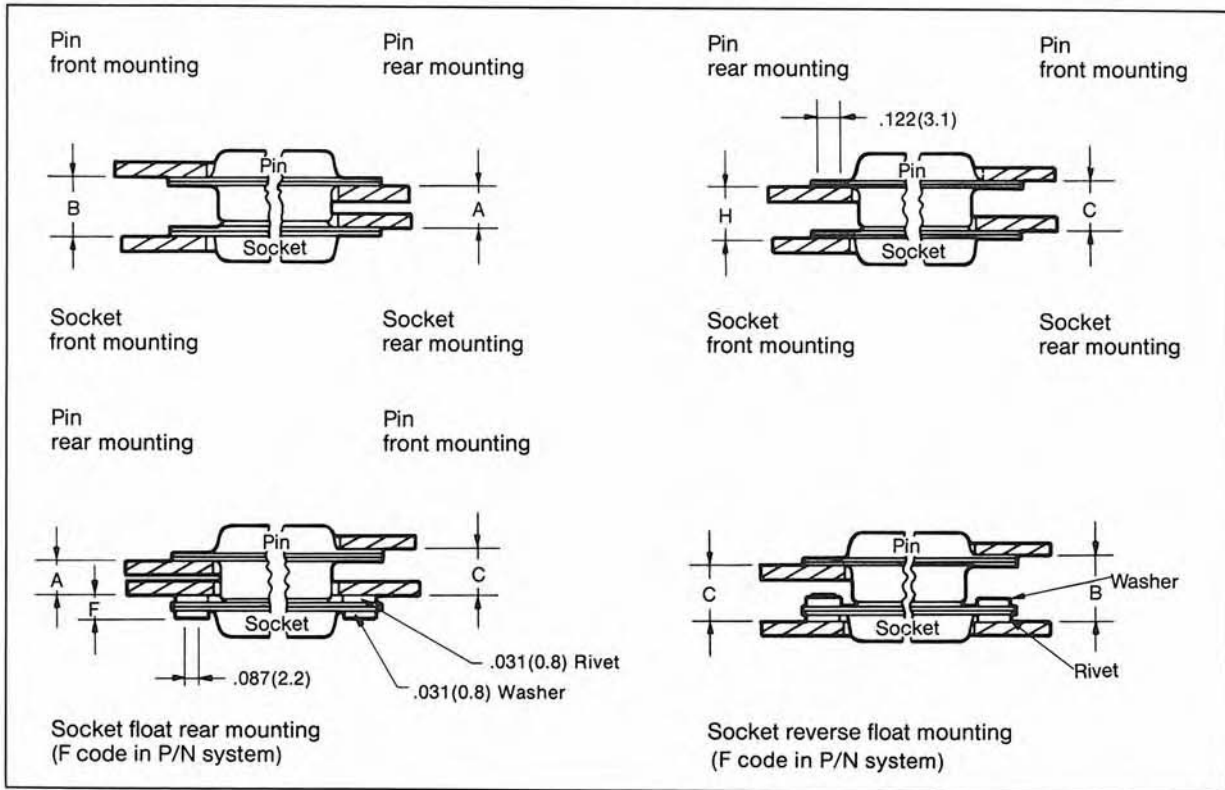

Note:

Plugs have pin contacts.

Receptacles have socket contacts

combination of mated connectors

Size	Pin	Socket	A +.030 0 (+0.76) 0	B +.030 0 (+0.76) 0	C +.030 0 (+0.76) 0	F 0 -.012 0 (-0.3)	H +.030 0 (+0.76) 0
E,A,B,C,D	Rigid	Rigid	.250(6.35)	.352(8.95)	.301(7.65)	—	.301(7.65)
E,A,B,C,D	Rigid	Float F	.219(5.55)	—	.270(6.85)	.130(3.3)	—
E,A,B,C,D	Float F	Rigid	.219(5.55)	—	.270(6.85)	.130(3.3)	—
E,A,B,C,D	Rigid	Float F	—	.360(9.15)	.321(8.15)	.130(3.3)	—
E,A,B,C,D	Float F	Rigid	—	.360(9.15)	.321(8.15)	.130(3.3)	—

Note: Dimensions are the same if socket or plug connectors are float mounted.

d-subminiature contact arrangements

printed circuit board cutouts

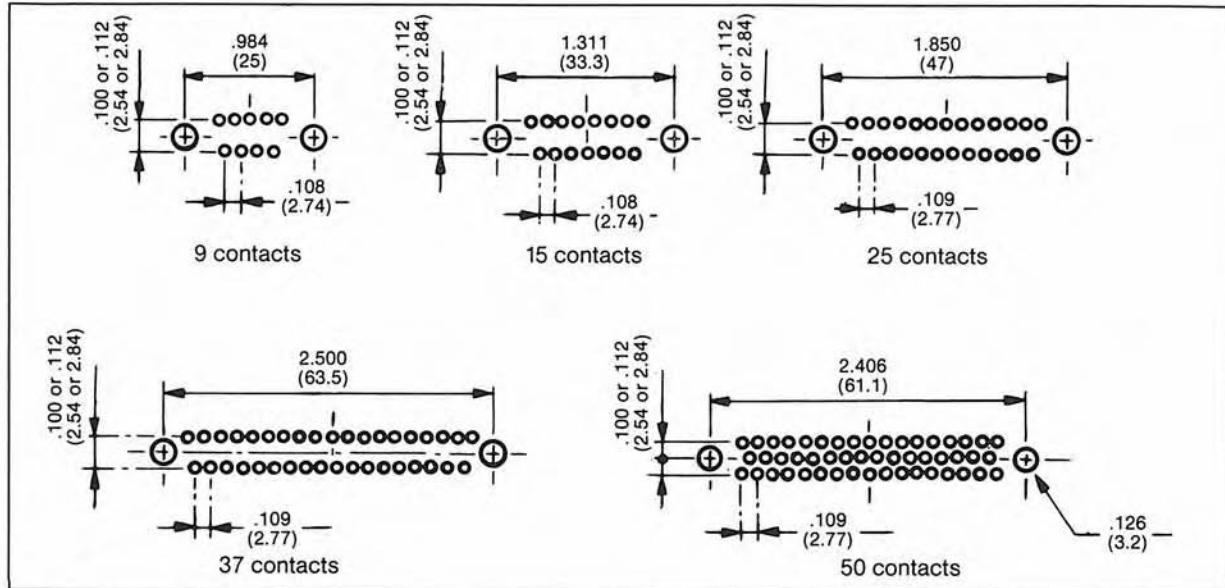

Solder pin diameter	.024(0.6)	.030(0.76)	.040(1.02)
P/C board hole diameter	.030(0.75) min	.035(0.9) min	.047(1.20) min

contact spacing

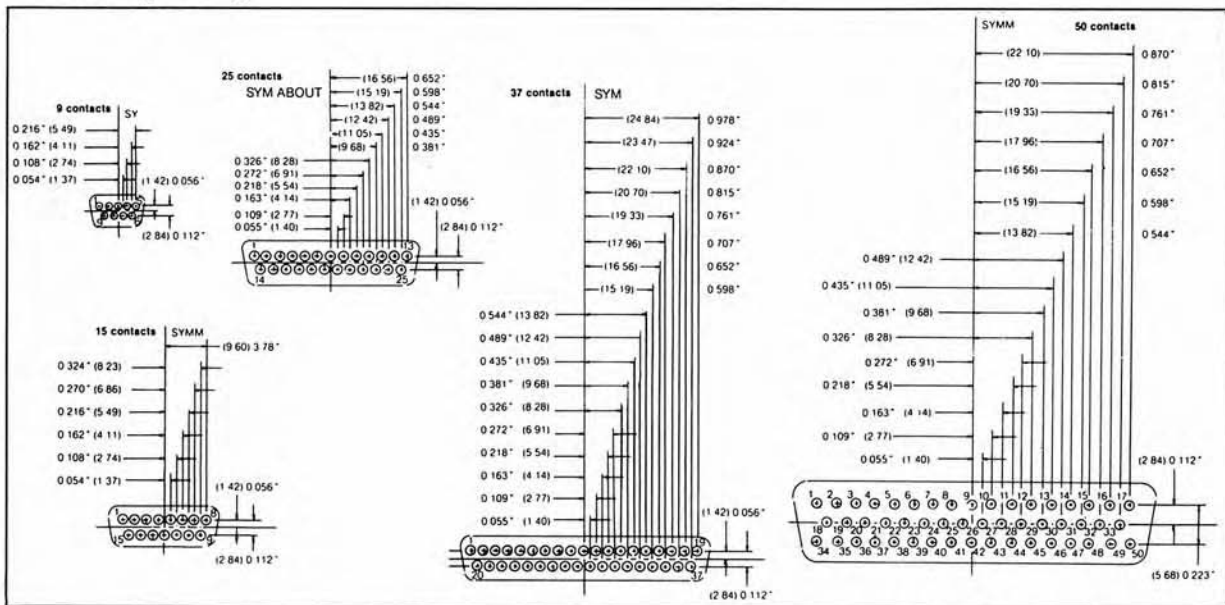

All dimensions: inches (millimeters)

d-subminiature overmold can

...superior EMI shielding & ESD protection

...for use with WPI®
d-subminiature
rear-release connectors
(117 / 177 / 777 series)



dimensions

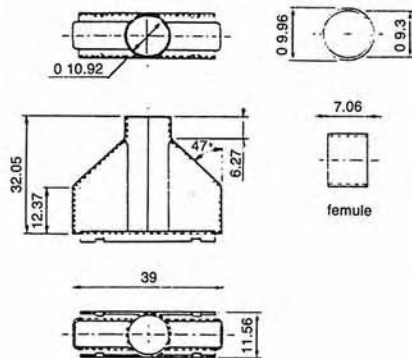

description

This one piece design offers improved shielding characteristics over competitive designs, as well as providing lower installed cost. The WPI® overmold can is available in the popular 25 contact size, and

incorporates a single ferrule for a variety of cable diameters, eliminating the need for inner / outer crimp typical of other offerings. The overmold can offers up to 40 dB shielding at one GHz.

specifications

hood: tin-plated cold rolled steel
ferrule: stainless steel
hood and ferrule plating: bright tin/lead over nickel

backshell: 94v0 thermoplastic.

ordering information

WPI® part number	contents	size
17-1826 (plug)	d-sub overmold can kit*	25
17-1827 (receptacle)	d-sub overmold can kit*	25
* WPI® overmold can kit is comprised of one overmold can with basic ferrule, a rear-release connector, 25 gold flash contacts, a backshell, a grommet, and thumb screws.		
17-9433-25	overmold can with ferrule**	25
** must be used in conjunction with WPI® d-sub connectors		

termination tooling

See Section 16 Page 2 for overmold can termination tools.