



Unsupported collet knobs $\frac{1}{4}$ in. (6.35 mm) dia. shaft

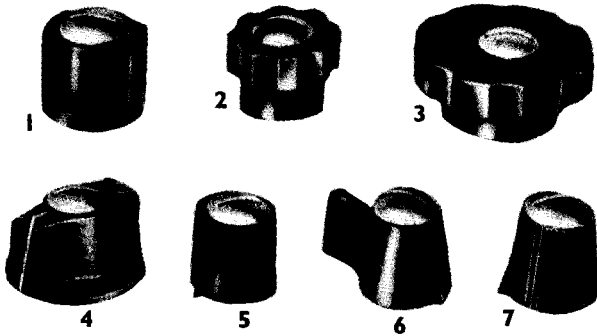

Photo Key No.	Description	Shape similar to Fig. No. DEF 5221	Plessey Part No.	Joint Services Catalogue No. 5355-99-942-
---------------	-------------	------------------------------------	------------------	---

1	Parallel, with indicator line, $1\frac{1}{8}$ in. (28.58 mm.) dia.	39	418/2/09027	8683
2	Fluted, $\frac{5}{16}$ in. (7.95 mm.) dia.	32	418/2/09020	8674
3	Fluted, $2\frac{1}{4}$ in. (57.15 mm.) dia.	30	418/2/09018	8677
4	Parallel, with indicator line, $1\frac{3}{4}$ in. (34.45 mm.) dia.	38	418/2/09026	8685
5	Fluted, with beak, 1 in. (25.4 mm.) dia.	41	418/2/09029	8678
6	Conical, with beak and tail, 1 in. (25.4 mm.) dia., tail $1\frac{1}{4}$ in. (31.75 mm.) from axis	36	412/2/09024	8667
7	Serrated, with beak 1 in. (25.4 mm.) dia.	34	418/2/09022	8690
—	Unsupported collet assembly	29	418/1/08010	8697

Supported collet knobs. $\frac{1}{4}$ in. (6.35 mm.) dia. shaft

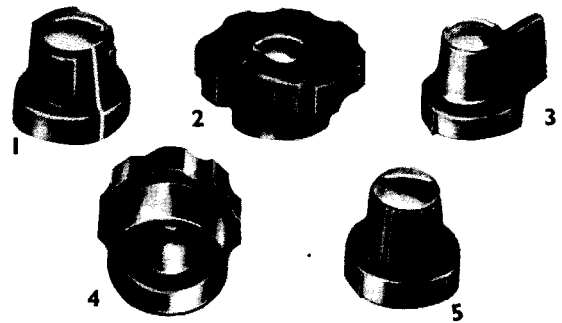
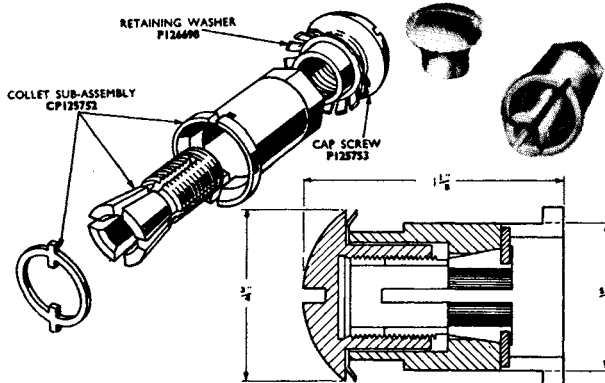
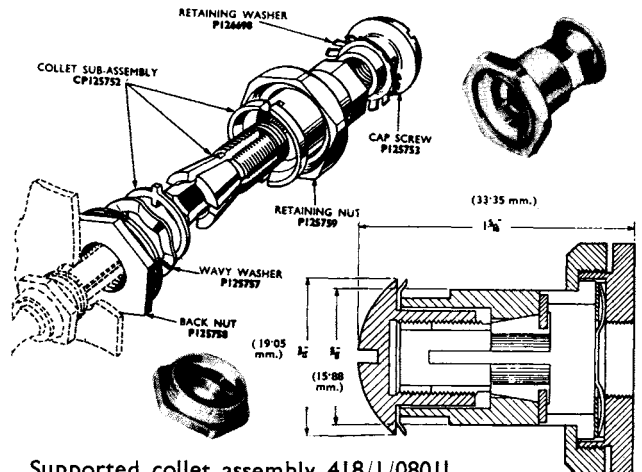

Photo Key No.	Description	Shape similar to Fig. No. DEF 5221	Plessey Part No.	Joint Services Catalogue No. 5355-99-
---------------	-------------	------------------------------------	------------------	---------------------------------------

1	Parallel, with indicator line $1\frac{5}{8}$ in. (33.35 mm.) dia.	56	418/2/09040	942-8684
2	Fluted, $2\frac{1}{4}$ in. (57.15 mm.) dia. (with quick wind)	—	418/1/07516	943-9871
3	Conical, with beak and tail, $1\frac{5}{8}$ in. (33.35 mm.) dia., tail $1\frac{1}{4}$ in. (31.75 mm.) (from axis)	52	418/2/09037	942-8668
4	Fluted, $1\frac{5}{8}$ in. (41.28 mm.) dia.	45	418/2/09032	942-8675
5	Serrated, with beak 1 in. (25.4 mm.) dia. (max. dia. $1\frac{5}{8}$ in. (33.35 mm.))	50	418/2/09035	942-8692
—	Supported collet assembly	43	418/1/08011	942-8698



Unsupported collet assembly 418/1/08010
(JS Cat. No. 5355-99-942-8697)



Supported collet assembly 418/1/08011
(JS Cat. No. 5355-99-942-8698)
Available as complete assembly only