

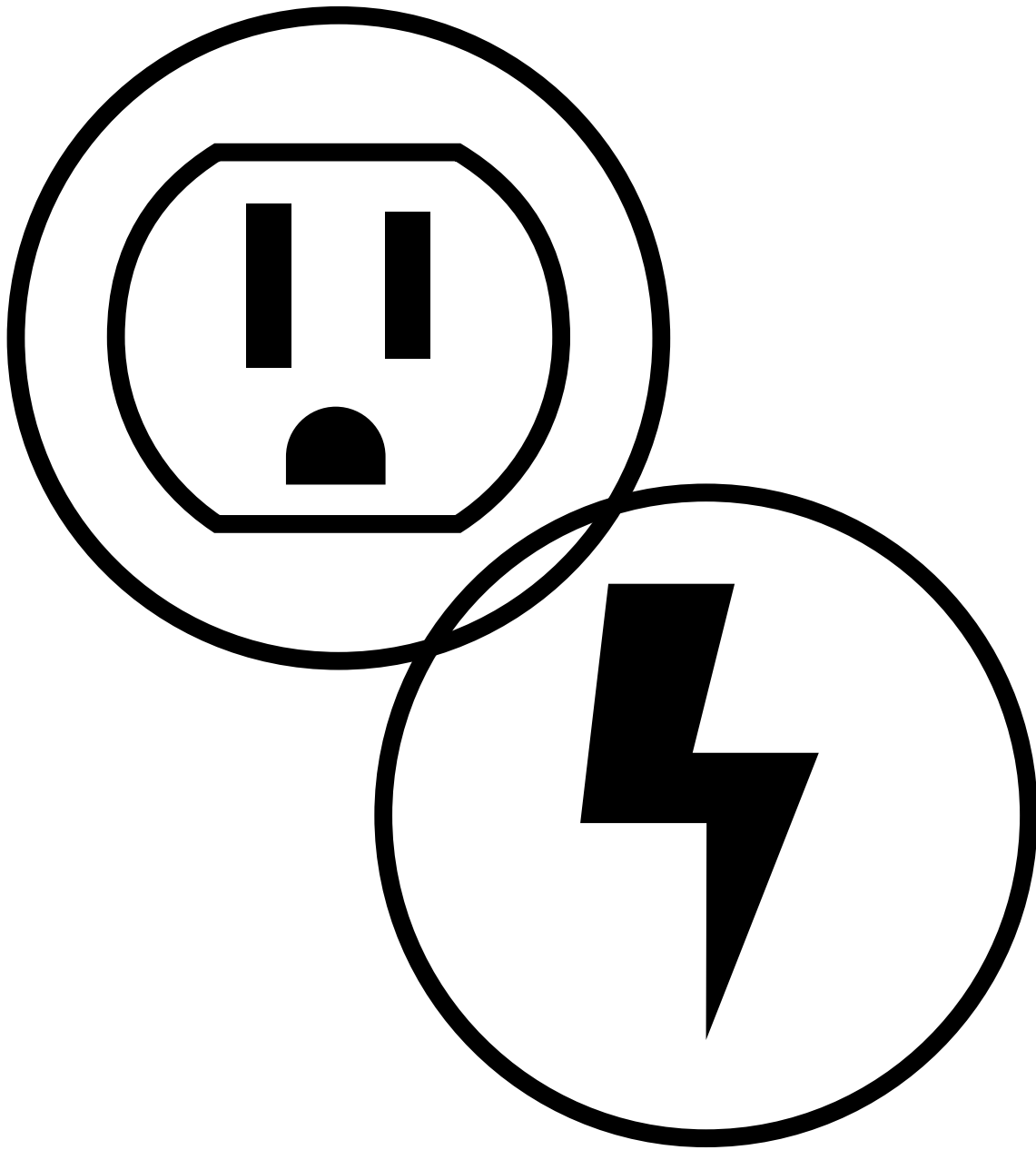

WORLD PRODUCTS INC.
ELECTRONIC COMPONENT SOLUTIONS



RFI SUPPRESSORS



RFI SUPPRESSORS

World Products' Metallized Polypropylene and Polyester RFI Suppressors are intended for use on line-to-line (X2) and line-to-ground (Y2) AC Mains. Our proprietary construction method allows these devices to withstand the stresses of high voltage transient pulses and remain safe according to international safety standards without degradation of performance. They are constructed of the finest materials available for the purpose of providing maximum reliability and long life. Stringent quality controls are used throughout production.

These suppressors are designed to suppress radio interference, conducted on the AC mains, generated from household appliances, computers, switch mode power supplies, and other electronic equipment. They are available in a wide range of capacitance values and industry standard case sizes.

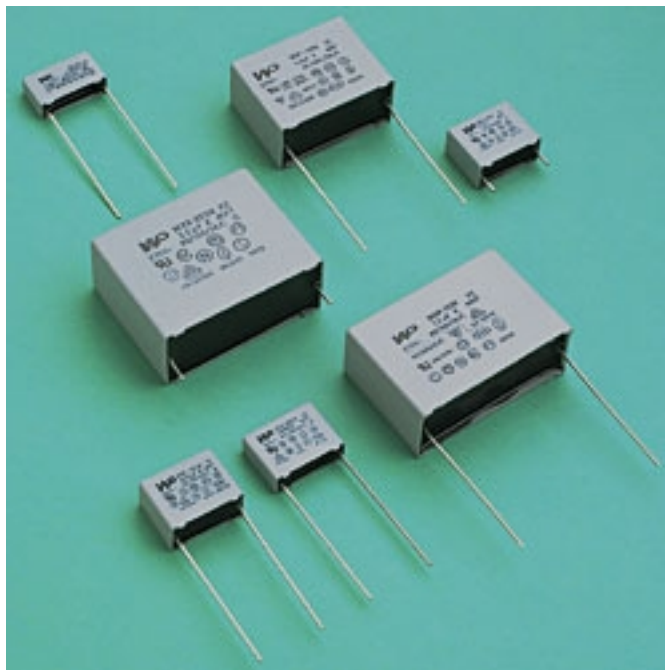

Featuring...

- International Safety Approvals
- Excellent Self Healing Properties
- High Dv/Dt Ratings
- Flame Retardant Encapsulation
- 100% Production Lot Testing
- Standard Electrical AQL - 0.065

Table of Contents

	Pg.
General Information	3
Technical Information	6
Typical Resonant Frequencies	7
WXP, WXPC, WYP Specifications	8
WXE Specifications	11
WYE Specifications	12
Taping Specifications	13
Marking and Safety Approvals	17

R.F.I. Suppressors - General Information

Product Description

RFI suppressors are a special class of capacitors for use on the AC power line inputs to electronic or electrical equipment. Their purpose is to eliminate or attenuate radio frequency interference voltages originated in the units connected to the same AC power branch and prevent them from mutually disturbing their operations.

They must endure very harsh conditions existing on the 60/50Hz AC power lines - including voltage surges and transients. Therefore, they must meet the requirements of EN 132-400 and IEC 384-14, 2nd edition 1993 standards enforced by international safety certification bodies, as well as UL-1414 and UL-1283 in USA.

Our RFI capacitors are made with metallized polypropylene or polyester films of the highest quality and have self healing properties. There are two classes of these capacitors: Line-to-Line X2 Class, and Line-to-Ground Y2 Class.

We have three series of X2 : WXP, WXPC and WXE series rated at 300VAC, *275VAC and 275VAC and two series of Y2 : WYP and WYE rated at 275VAC and 250 VAC. WXP, WXPC (smaller dimensions) and WYP series are made with polypropylene film. WXE and WYE series are made with polyester film.

While polypropylene and polyester series are compatible, polypropylene dielectrics are more popular worldwide and have smaller dissipation factor (DF) improving operation at higher frequencies. Also, due to larger production volumes polypropylene capacitors are less expensive.

World Products has excelled in serving customer needs, providing a full line of protection products. We also offer to our customers the technical support of our Applications Laboratory equipped with industry standard, test equipment that can duplicate most safety agency testing.

Our manufacturing plant has received the Certificate of Quality Assurance System according to the ISO9001 standard.

We invite you to contact World Products and put us to the test. We can best prove our “commitment to excellence” by actually working for you.

* 2.2-6.8 μ F rated at 300VAC (600VDC).

R.F.I. Suppressors - General Information - Continued

Note

All our capacitors listed below have Climatic Category: IEC 40/100/56 C, and Operating Temperature Range: -40 to +100°C

Metallized Polypropylene Film Capacitors

	X2 - WXP	X2 - WXPC		Y2 - WYP
Capacitance Range	0.01 - 2.2 μ F	0.01 - 1.5 μ F	2.2 - 6.8 μ F	0.01 - 0.1 μ F
Rated Voltage	300VAC (600VDC) 50/60Hz to 440Hz	275VAC (560VDC) 50/60Hz to 440Hz	300VAC (600VDC) 50/60Hz to 440Hz	275VAC (650VDC) 50/60Hz to 440Hz
Tolerance	\pm 10% - \pm 20%	\pm 10% - \pm 20%	\pm 5% - \pm 10% - \pm 20%	\pm 20%

Metallized Polyester Film Capacitors

	X2 - WXE	Y2 - WYE
Capacitance Range	0.01 - 2.2 μ F	0.001 - 0.022 μ F
Rated Voltage	275VAC (560VDC) 50/60Hz	250VAC (600VDC) 50/60Hz
Tolerance	\pm 10%	\pm 20%

Definition of Terms

Capacitance

Capacitance values are measured and specified for 1KHz at 25°C

Dissipation Factor (DF)

The measure of the suppressor's dielectric loss at 1KHz also called tangent of loss angle. It is the ratio of loss power to the reactive power across capacitor that is customarily expressed in % (Ratio = $\tan F = .01 \rightarrow DF = 1\%$). At large DF and operation above specified limits loss power may cause significant internal heating leading to destructive breakdown. All of our suppressors are designed and made with top quality materials to minimize DF.

Insulation Resistance (IR)

Measurement of the specified IR is made after applying 100 VDC for one minute at 25°C. The proprietary multiple dielectric design of our suppressors provides higher insulation resistance than single dielectric suppressors.

R.F.I. Suppressors - General Information - Continued

Climatic Category

According to international safety standards, IEC 60384-14, and IEC 60068-2, suppressors must be categorized according to the rated lowest temperature / the rated highest temperature / the number of days samples are subjected to damp humidity test - in our case: 56 days - which is the absolute maximum rating category.

Rated Voltage

The rated voltage is the maximum RMS AC voltage which can be applied continuously within the specified Rated Temperature range.

Rated Temperature Range

The maximum low and high ambient temperature at which the rated voltage can be continuously applied.

Endurance Life Test

Production samples are subjected to a periodic life endurance testing to comply with international safety approval standards. These tests specify that the suppressor shall have 1.25 x rated voltage (X2) and 1.7 x rated voltage (Y2) applied for a period of 1,008 hours at an elevated temperature of 100°C. We test our WXE and WYE suppressors with the above endurance voltages, not only at the time of type approval, but also at 6 month intervals. In addition to the above voltages applied constantly, 1000 VAC is applied once each hour for 0.1 second. Both the steady state and momentary (0.1 sec) 1000 VAC voltage is applied through a 47 ohm \pm 5% resistor simulating the high frequency impedance of AC mains. After the endurance life test, capacitance shall not deviate more than 5% of the initial value, IR shall not be less than 50% of the initial value and DF shall not be greater than the specified. The combined stress of both voltages applied is proof that these suppressors are capable of withstanding high line conditions that are often present on the AC mains.

dv/dt

The maximum acceptable voltage rate of change per μ sec of rise or fall time as defined below:

$$dv/dt = \frac{V_R}{R \times C}$$

V_R = Rated DC Voltage

R = Discharge Resistor

C = Capacitance Tested

R.F.I. Suppressors - Technical Specifications

Electrical Specifications

Dissipation Factor (DF)	WXE and WYE = $\leq 0.8\%$ at 1KHz		
Insulation Resistance (IR)	≥ 30000 Mohm for $C_R \leq 0.33\mu\text{F}$		
	≥ 10000 Ohm Farads for $C_R > 0.33\mu\text{F}$ Measured at 100 VDC after 60 seconds at $+25^\circ\text{C}$.		
Test Voltage	WXE - X2 Class	2000 VDC $C_R \leq 0.68\mu\text{F}$ 1850 VDC $C_R > 1\mu\text{F}$	2 seconds
	WYE - Y2 Class	3000VDC $C_R \leq 0.0047\mu\text{F}$ 2700 VDC $C_R > 0.0068\mu\text{F}$	2 seconds
	WXP - X2 Class	2150 VDC for all	1 second
	WXPC - X2 Class	2150 VDC for all	1 second
	WYP - Y2 Class	2700 VDC for all	2 seconds

Our factory tests each production lot for 100% to the test voltages listed above. After the test voltage has been applied, 100% of all production is tested for DF, IR and capacitance to insure all suppressors comply with electrical specifications.

Mechanical Specifications

Dimensions	See Specification Tables	
Vibration	IEC 68 - 2 - 6, test FC	3 directions at 2 hours each 10-500 Hz at 98 m/s^2
Bump	IEC 68 - 2 - 29, test Eb	4000 Bumps at 390 m/s^2
Solderability	Military Standard 202E, Method 208C IEC 68 - 2 - 20, test TC.	
Fire Hazard	UL1414 IEC 695 - 2 - 2	According to Section 18 in this Standard $P \geq 15\text{mm}$, 120 seconds $P \leq 15\text{mm}$, 60 seconds.
Humidity	IEC 68 - 2 - 3, test Ca	X Class 56 days. Y Class 56 days.
Plastic Case	UL 94V - 0	Flame Retardant, Molded Plastic, Epoxy Resin Sealed.

Dissipation Factor (DF)

WXP and WXPC— $\leq 0.15\%$ at 10kHz for $C_R \leq 0.1\mu\text{F}$
 — $\leq 0.50\%$ at 10kHz for $C_R \leq 1.0\mu\text{F}$
 — $\leq 0.10\%$ at 1kHz for $C_R > 1.0\mu\text{F}$
 WYP — $\leq 0.08\%$ at 10kHz

(C_R — Capacitance Range)

R.F.I. Suppressors - Typical Resonant Frequencies

Y2 Class Resonant fo

Type	C(μf)	fo - MHz	Type	C(μf)	fo - MHz
WYE-102M	0.0010	53	WYE-153M WYP-153M	0.0150	12
WYE-152M	0.0015	42			
WYE-222M	0.0022	35	WYE-223M WYP-223M	0.0220	10
WYE-252M	0.0025	33			
WYE-332M	0.0033	29	WYP-273M	0.0270	8.1
WYE-392M	0.0039	25	WYP-333M	0.0330	6.9
WYE-472M	0.0047	21	WYP-473M	0.0470	5.5
WYE-682M	0.0068	19	WYP-683M	0.0680	4.7
WYE-103M WYP-103M	0.0100	15	WYP-104M	0.1000	4.0

X2 Class Resonant fo

Type	C(μf)	fo - MHz	Type	C(μf)	fo - MHz
****-103K	0.010	13.0	****-224K	0.22	2.7
****-153K	0.015	10.4	WXPC-274K(only)	0.27	2.5
****-223K	0.022	8.5	****-334K	0.33	2.3
****-333K	0.033	6.9	****-474K	0.47	1.9
****-473K	0.047	6.0	****-684K	0.68	1.6
****-683K	0.068	4.7	****-105K	1.00	1.3
****-104K	0.100	4.0	****-155K	1.50	1.0
****-154K	0.150	3.4	****-225K	2.20	0.85
**** = WXE, WXP, WXPC			**** = WXE, WXP, WXPC		

1. All measurements are based on 5mm lead lengths at nominal C values.
2. Actual resonant frequencies will depend also on the total length of the circuit connections to the capacitor terminals and capacitor's actual C value. The tolerances for our capacitors are: ±10% for WXE, WXP, WXPC series of X2 class. ±20% for WYE, WYP Series Y2 class.
3. WYE and WXE are made with metallized polyester film. WXP, WXPC and WYP are made with metallized polypropylene film.

R.F.I. Suppressors - WXP, WXPC, WYP Specifications

Physical Dimensions for WXP, WXPC, WYP

Uninsulated Leads Versions 00 - 01

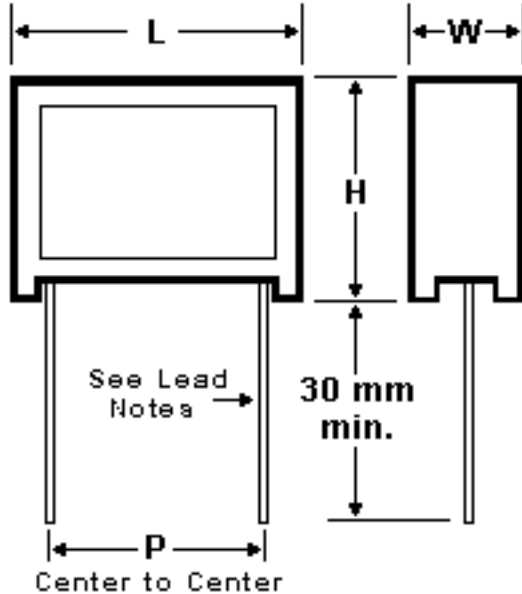

Insulated Leads Versions 02 - 03 Only WXP and WXPC

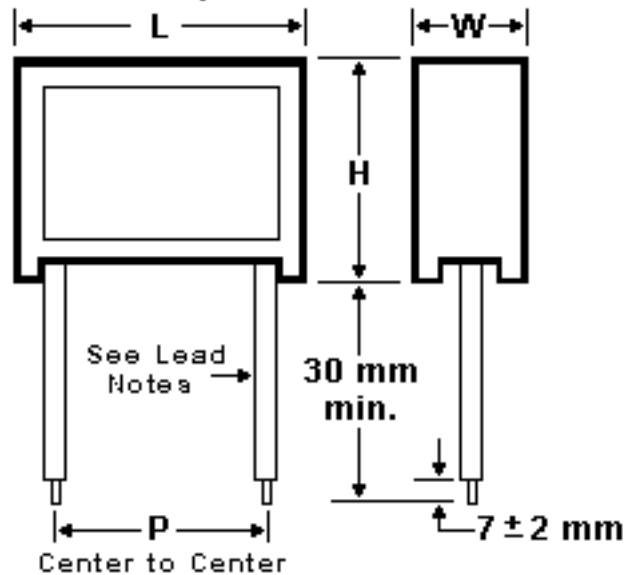

Available with uninsulated or insulated leads

Lead Notes:

1. (AB) = 2 digits leads length code in mm.
2. All insulated leads have 7.0mm striped and tinned ends.

Standard Lead Lengths		
Lead cut suffixes -L04, -L05 & -L06 for 4mm, 5mm, 6mm \pm 1mm lead lengths respectively	6mm \pm 1mm short leads	Solid uninsulated wire $\phi = 0.8\text{ mm}$
Standard	35mm \pm 5mm long leads	Solid uninsulated wire $\phi = 0.8\text{ mm}$
Suffix - 02	35mm \pm 5mm solid cu wire	0.8 mm diameter, PCV insulated
Suffix - 03	35mm \pm 5mm stranded cu wire	0.5 mm ² PCV insulated
Non-standard Lead Lengths		
Suffix - 02*	Solid cu wire	0.8 mm diameter, PCV insulated
Suffix - 03*	Stranded cu wire	0.5 mm ² PCV insulated

* See lead cut codes above -L04, -L05 & -L06.

R.F.I. Suppressors - WXP, WXPC, WYP Specifications

WXP Specifications

Part Number	Cap. (μF)	L ± 0.3 mm	H ± 0.3 mm	W ± 0.3 mm	P mm	Quantity Per Box	
						Long Lead 30-35mm	Short Lead 4, 5, 6mm
WXP-103K	0.010	18.0	10.5	5.5	15.0 \pm 0.5	500	1300
WXP-153K	0.015	18.0	10.5	5.5	15.0 \pm 0.5	500	1300
WXP-223K	0.022	18.0	10.5	5.5	15.0 \pm 0.5	500	1300
WXP-333K	0.033	18.0	10.5	5.5	15.0 \pm 0.5	500	1300
WXP-473K	0.047	18.0	12.5	6.5	15.0 \pm 0.5	400	950
WXP-683K	0.068	18.0	13.5	7.5	15.0 \pm 0.5	400	750
WXP-104K	0.100	18.0	14.5	8.5	15.0 \pm 0.5	400	650
WXP-154K	0.150	26.5	15.5	7.5	22.5 \pm 0.5	200	480
WXP-224K	0.220	26.5	16.5	8.5	22.5 \pm 0.5	200	400
WXP-334K	0.330	26.5	18.5	10.5	22.5 \pm 0.5	150	330
WXP-474K	0.470	31.5	20.5	11.5	27.5 \pm 0.7	100	220
WXP-684K	0.680	31.5	23.5	13.5	27.5 \pm 0.7	100	150
WXP-105K	1.000	31.5	24.5	15.0	27.5 \pm 0.7	80	140
WXP-155K	1.500	41.5	28.5	16.0	37.5 \pm 0.7	40	80
WXP-225K	2.200	41.5	33.0	18.0	37.5 \pm 0.7	40	80

dv/dt up to 0.1 μF = 500v/ μs

dv/dt 0.15 μF to 0.68 μF = 300v/ μs

dv/dt 1.0 μF to 2.2 μF = 200v/ μs

WYP Specifications

Part Number	Cap. (μF)	L ± 0.3 mm	H ± 0.3 mm	W ± 0.3 mm	P mm	Quantity Per Box	
						Long Lead 30-35mm	Short Lead 4, 5, 6mm
WYP-103M	0.010	18.0	10.5	5.5	15.0 \pm 0.5	500	1300
WYP-153M	0.015	18.0	12.5	6.5	15.0 \pm 0.5	400	950
WYP-223M	0.022	18.0	13.5	7.5	15.0 \pm 0.5	400	750
WYP-273M	0.027	18.0	14.5	8.5	15.0 \pm 0.5	400	650
WYP-333M	0.033	18.0	17.0	8.5	15.0 \pm 0.5	300	550
WYP-473M	0.047	26.5	15.5	7.5	22.0 \pm 0.5	200	480
WYP-683M	0.068	26.5	16.5	8.5	22.0 \pm 0.5	200	400
WYP-104M	0.100	26.5	18.5	10.5	22.5 \pm 0.5	150	330

dv/dt up to 0.033 μF = 700v/ μs

dv/dt 0.047 μF to 0.1 μF = 500v/ μs

R.F.I. Suppressors - WXP, WXPC, WYP Specifications

WXPC Specifications

Part Number	Cap. (μF)	L ± 0.3 mm	H ± 0.3 mm	W ± 0.3 mm	P mm	Quantity Per Box	
						Long Lead 30-35mm	Short Lead 4, 5, 6mm
WXPC-103K	0.010	13.0	10.5	4.5	10.0 \pm 0.5	1000	2200
WXPC-153K	0.015	13.0	10.5	4.5	10.0 \pm 0.5	1000	2200
WXPC-223K	0.022	13.0	10.5	5.5	10.0 \pm 0.5	1000	1800
WXPC-333K	0.033	13.0	12.5	5.5	10.0 \pm 0.5	800	1500
WXPC-473K	0.047	13.0	13.5	5.5	10.0 \pm 0.5	800	1400
WXPC-473K1	0.047	18.0	10.5	5.5	15.0 \pm 0.5	500	1300
WXPC-683M	0.068	18.0	10.5	5.5	15.0 \pm 0.5	500	1300
WXPC-104K	0.100	18.0	12.5	6.5	15.0 \pm 0.5	400	950
WXPC-154K	0.150	18.0	14.5	8.5	15.0 \pm 0.5	400	650
WXPC-224K	0.22	18.0	17.0	8.5	15.0 \pm 0.5	300	550
WXPC-224K1	0.22	26.5	15.5	7.5	22.5 \pm 0.7	200	480
WXPC-274K	0.27	26.5	15.5	7.5	22.5 \pm 0.7	200	480
WXPC-334K	0.33	26.5	16.5	8.5	22.5 \pm 0.7	200	400
WXPC-474K	0.47	26.5	18.5	10.5	22.5 \pm 0.7	150	330
WXPC-684K	0.68	31.5	20.5	11.5	27.5 \pm 0.7	100	220
WXPC-105K	1.0	31.5	23.5	13.5	27.5 \pm 0.7	100	150
WXPC-155M	1.5	31.5	24.5	15.0	27.5 \pm 0.7	80	140
		L ± 0.5 mm	H ± 0.5 mm	W ± 0.5 mm			
WXPC-225K	2.2	41.5	28.5	16.0	37.5 \pm 0.7	40	80
WXPC-335K	3.3	41.5	33.0	18.0	37.5 \pm 0.7	40	80
WXPC-475K	4.7	42.0	38.0	21.0	37.5 \pm 0.7	24	50
WXPC-685M	6.8	42.0	38.0	21.0	37.5 \pm 0.7	24	50

dv/dt up to 0.1 μF = 500v/ μs

dv/dt 0.15 μF to 0.68 μF = 300v/ μs

dv/dt 1.0 μF to 1.5 μF = 200v/ μs

dv/dt 2.2 μF to 6.8 μF = 100v/ μs

R.F.I. Suppressors - WXE Specifications

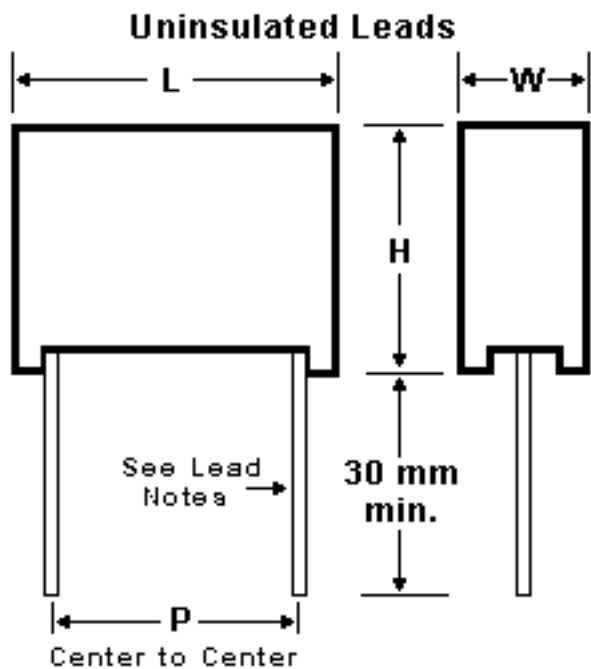

Standard Lead Lengths		
Lead cut suffixes -L04, -L05 & -L06 for 4mm, 5mm, 6mm ±1mm lead lengths respectively	6mm ± 1mm short leads	Solid uninsulated wire $\varnothing = 0.8$ mm
Standard	35mm ± 5mm long leads	Solid uninsulated wire $\varnothing = 0.8$ mm

Note: WXE Series will only be available for shipment through 6/1/2004 as it is obsoleted in favor of WXP Series.

WXE Specifications

Part Number	Cap. (μ F)	L max mm	H max mm	W max mm	P ± 0.5 mm	Quantity Per Box	
						Long Lead 30-35mm	Short Lead 4, 5, 6mm
WXE-103K	0.010	18.0	10.5	5.5	15.0	500	1300
WXE-153K	0.015	18.0	10.5	5.5	15.0	500	1300
WXE-223K	0.022	18.0	10.5	5.5	15.0	500	1300
WXE-333K	0.033	18.0	10.5	5.5	15.0	500	1300
WXE-473K	0.047	18.0	12.5	6.5	15.0	400	950
WXE-683K	0.068	18.0	13.5	7.5	15.0	400	750
WXE-104K	0.100	18.0	14.5	8.5	15.0	400	650
WXE-154K	0.150	26.5	15.5	7.5	22.5	200	480
WXE-224K	0.220	26.5	16.5	8.5	22.5	200	400
WXE-334K	0.330	26.5	18.5	10.5	22.5	150	330
WXE-474K	0.470	31.5	20.5	11.5	27.5 *	100	220
WXE-684K	0.680	31.5	23.5	13.5	27.5 *	100	150
WXE-105K	1.000	31.5	24.5	15.0	27.5 *	80	140
WXE-155K	1.500	41.5	28.5	16.0	37.5 *	40	80
WXE-225K	2.200	41.5	33.0	18.0	37.5 *	40	80

* = These parts are ± 0.7 mm.

dv/dt up to 0.1 μ F = 300v/ μ s

dv/dt 0.15 μ F to 0.68 μ F = 150v/ μ s

dv/dt 1.0 μ F to 2.2 μ F = 100v/ μ s

R.F.I. Suppressors - WYE Specifications

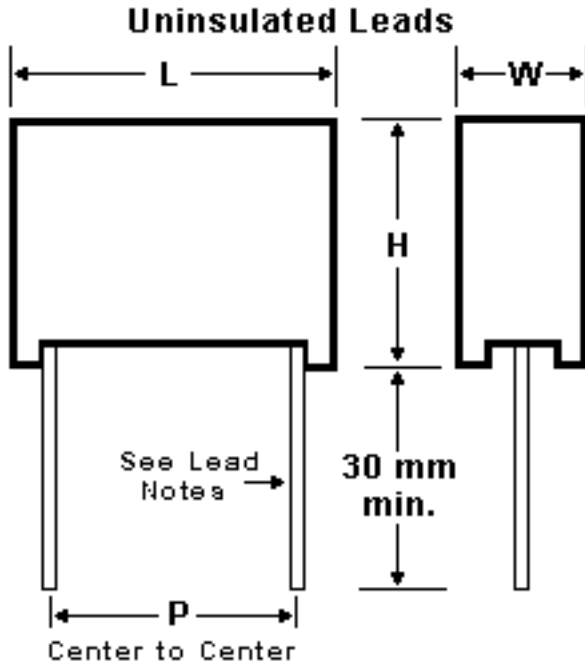

Standard Lead Lengths		
Lead cut suffixes -L04, -L05 & -L06 for 4mm, 5mm, 6mm ±1mm lead lengths respectively	6mm ± 1mm short leads	Solid uninsulated wire $\varnothing = 0.8$ mm
Standard	35mm ± 5mm long leads	Solid uninsulated wire $\varnothing = 0.8$ mm

WYE Specifications

Part Number	Cap. (μF)	L max mm	H max mm	W max mm	P ± 0.5 mm	Quantity Per Box	
						Long Lead 30-35mm	Short Lead 4, 5, 6mm
WYE-102M	0.0010	13.0	10.5	4.5	10.0	1000	2200
WYE-152M	0.0015	13.0	10.5	4.5	10.0	1000	2200
WYE-222M	0.0022	13.0	10.5	5.5	10.0	1000	1800
WYE-252M	0.0025	13.0	10.5	5.5	10.0	1000	1800
WYE-332M	0.0033	13.0	12.5	5.5	10.0	800	1500
WYE-392M	0.0039	13.0	12.5	5.5	10.0	800	1500
WYE-472M	0.0047	13.0	13.5	5.5	10.0	800	1400
WYE-682M	0.0068	18.0	14.0	5.5	15.0	500	1000
*WYE-103M	0.0100	18.0	13.5	7.5	15.0	400	750
*WYE-153M	0.0150	18.0	14.5	8.5	15.0	400	650
*WYE-223M	0.0220	18.0	17.0	8.5	15.0	300	550

dv/dt up to $0.0047\mu\text{F} = 1000\text{v}/\mu\text{s}$

dv/dt $0.0068\mu\text{F}$ to $0.022\mu\text{F} = 600\text{v}/\mu\text{s}$

* Note: These WYE values will only be available for shipment through 6/1/2004 as these values will be obsoleted in favor of WYP Series.

R.F.I. Suppressors - Taping Specifications

Taping of Capacitors

The original lead spacing of 10.0 mm (suffix code — T1)
 (the pitch of holes on carrier tape = 12.7 mm) (All dimensions in mm)

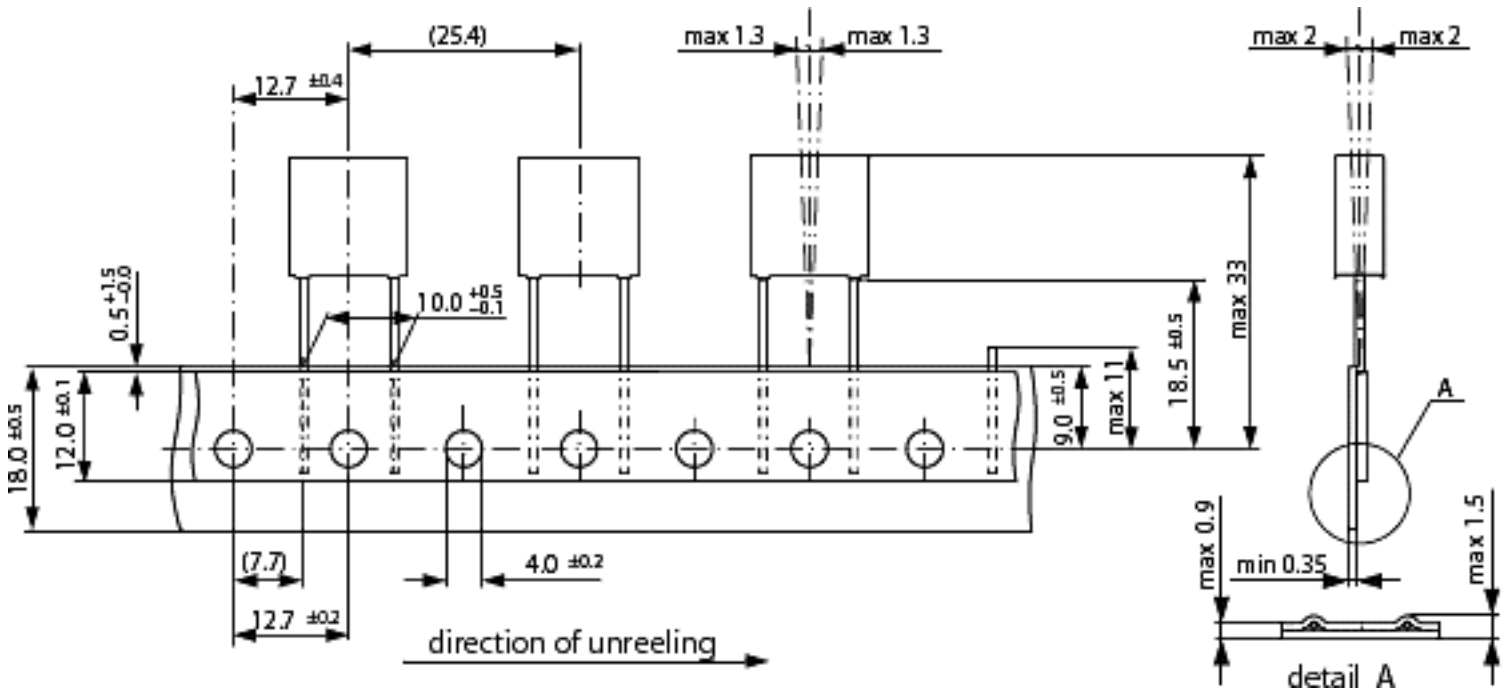

The original lead spacing of 15.0 mm (suffix code — T2)
 (the pitch of holes on carrier tape = 12.7 mm) (All dimensions in mm)

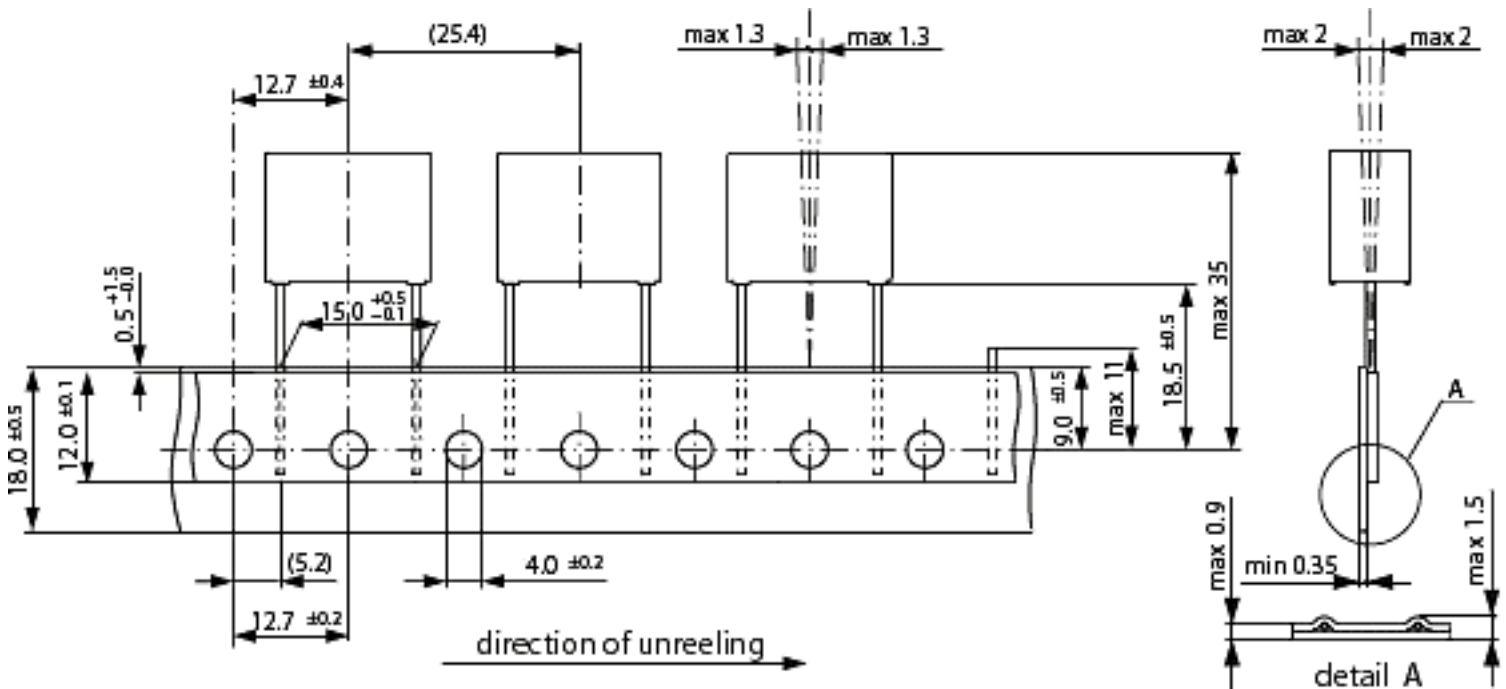

R.F.I. Suppressors - Taping Specifications (cont.)

Taping of Capacitors

The original lead spacing of 15.0 mm crimped to the lead spacing of 7.5 mm (suffix code — T4)
(the pitch of holes on carrier tape = 15.0 mm) (All dimensions in mm)

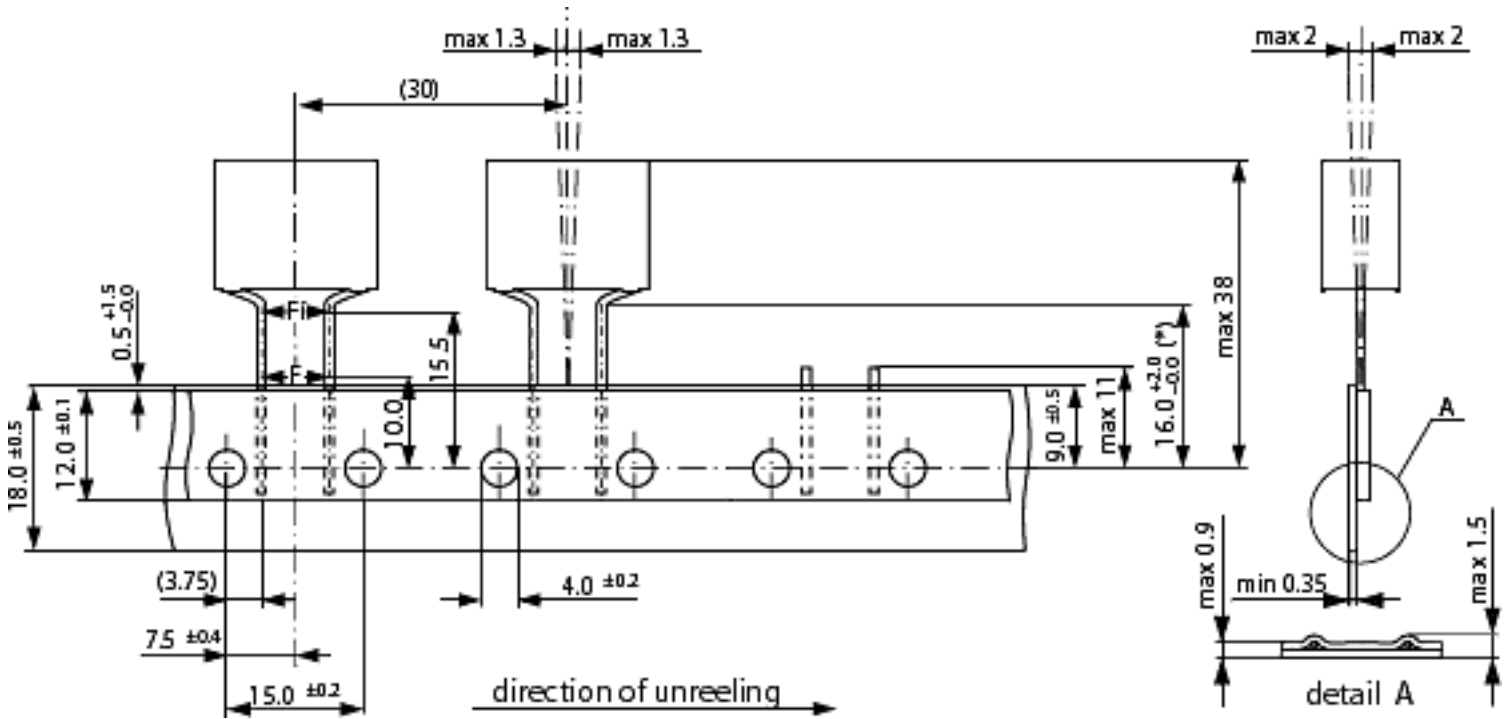

R.F.I. Suppressors - Taping Specifications (cont.)

Packaging of Capacitors

AMMO Packing

Capacitor case dimension (W x H x L)	Lead spacing	Number of taped capacitors per box
mm	mm	pcs
4.5 x 10.5 x 13.0	10.0	516
5.5 x 10.5 x 13.0	10.0	420
5.5 x 12.5 x 13.0	10.0	420
5.5 x 13.5 x 13.0	10.0	420
5.5 x 10.5 x 18.0	15.0	420
5.5 x 14.0 x 18.0	15.0	420
6.5 x 12.5 x 18.0	15.0	360
7.5 x 13.5 x 18.0	15.0	312
8.5 x 14.5 x 18.0	15.0	276
8.5 x 17.0 x 18.0	15.0	276
4.5 x 10.5 x 13.0	10.0 / 7.5	860
5.5 x 10.5 x 13.0	10.0 / 7.5	700
5.5 x 12.5 x 13.0	10.0 / 7.5	700
5.5 x 13.5 x 13.0	10.0 / 7.5	700
5.5 x 10.5 x 18.0	15.0 / 7.5	350
5.5 x 14.0 x 18.0	15.0 / 7.5	350
6.5 x 12.5 x 18.0	15.0 / 7.5	300
7.5 x 13.5 x 18.0	15.0 / 7.5	260
8.5 x 14.5 x 18.0	15.0 / 7.5	230
8.5 x 17.0 x 18.0	15.0 / 7.5	230

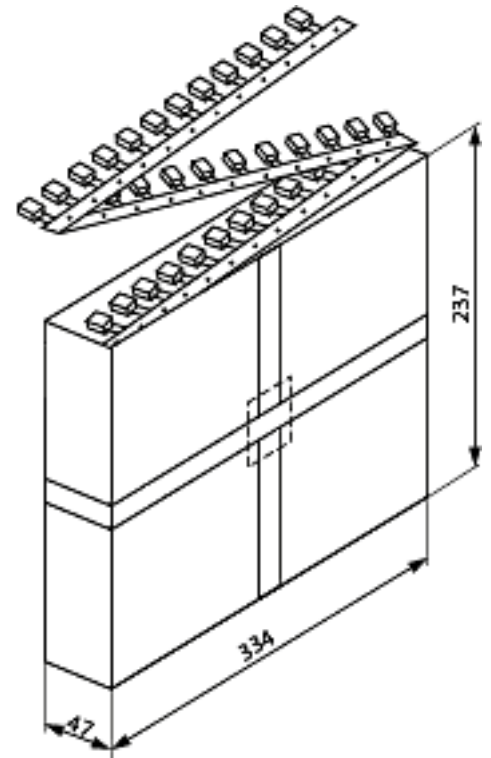

Requirements

1. A maximum of 2 consecutive capacitors may be missing provided this gap is followed by 6 consecutive capacitors.
2. The maximum number of empty places per reel shall not exceed 0.5% of the total number of the capacitors per reel.
3. Cumulative pitch error over 20 pitches: ± 1.0 mm.
4. The other taping requirements: acc. to EN/IEC 60286-2 & EIA-468-B.

R.F.I. Suppressors - Marking and Safety Approvals

Marking

- World Products Inc. Logo
- Part Number & Film Symbol (MKP or MKT)
- Capacitance
- Rated Voltage
- Climatic Category
- Class (X2 or Y2)
- Safety Approval Marking
- EIA Date Code (YYWW) Year & Week #

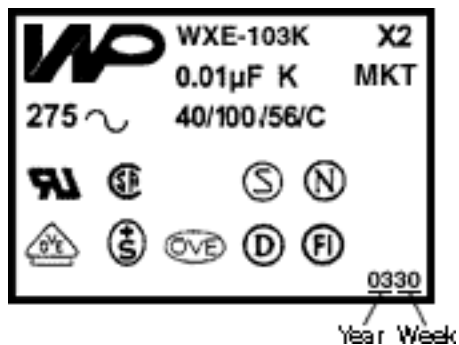

Safety Approval References

Symbol	Country	Reference	WXE File	WYE File	WXP File	WXPC File	WYP File
UL	USA	UL 1283	E119899	E119899	E119899	E119899	E119899
C-UL	USA	UL 1414	E71602	E71602	E71602	E71602	E71602
CSA	Canada	22.2 No.1 & No.8	LR86091	LR86091	LR86091		
VDE	Germany	*	83647	87425	94633	94633	132747
D	Denmark	*	117323JJa	117324JJa			
FI	Finland	*	180398-01	180397-01			
N	Norway	*	P95100026	L94150			
OVE	Austria	OVE-F22/179	348556-13115	348556-13115			
S	Sweden	*	9447241	9409048			
SEV	Switzerland	*	93,1 01346,02	93,1 01346,06			

*Approval test standards: EN132400, 1994/IEC 384-14, 2nd Edition, 1993

NOTES:

1. UL1414 and CSA 22.2 No. 1 approvals apply only up to 1µF.
2. WXE 0.68µF through 1.0µF do not have UL1414 and CSA 22.2 No. 1 approvals.