



GL4xxe Operator's Manual

For printer models:
GL4xxe series



Read this Operator's Manual before and during the servicing of the above product. Keep this document handy for future reference.

SATO International Pte Ltd
438A Alexandra Road
#05-01/02
Alexandra Technopark
Singapore 119967
Tel: (65) 6271 2122
Fax: (65) 6271 2151
Email: customerservice@sato-int.com

**Be sure to ask your dealer about our maintenance contracts
to ensure peace of mind during your usage of SATO products**

Version: SI-GL4xxe-01rB-11-11-OM

© Copyright 1994 – 2007

SATO International Pte Ltd

Warning: This equipment complies with the requirements in Part 15 of FCC rules for a Class A computing device. Operation of this equipment in a residential area may cause unacceptable interference to radio and TV reception requiring the operator to take whatever steps are necessary to correct the interference.

All rights reserved. No part of this document may be reproduced or issued to third parties in any form whatsoever without the express permission of SATO. The materials in this document are provided for general information and are subject to change without notice. SATO assumes no responsibilities for any errors that may appear.

PN: 9001163B

Worldwide Contact Details

International Headquarters	Americas
SATO INTERNATIONAL PTE. LTD 438A Alexandra Road #05-01/04, Alexandra Technopark, Singapore 119967 Phone: 65-6271-2122 Fax: 65-6271-2151 Email: sales@sato-int.com	SATO INTERNATIONAL AMERICA, INC. (Regional HQ) 10350 Nations Ford Road Suite A, Charlotte, NC 28273 Phone: 1-704-644-1650 Fax: 1-704-644-1662 Email: sato-sales@satoamerica.com
Americas	
SATO AMERICA, INC. 10350 Nations Ford Road Suite A, Charlotte, NC 28273 Phone: 1-704-644-1650 Fax: 1-704-644-1662 Email: sato-sales@satoamerica.com	SATO LABELING SOLUTIONS AMERICA, INC. 1140 Windham Parkway, Romeoville, Illinois 60446 Phone: 630-771-4200 Fax: 630-771-4210 Email: sales@sato-labeling.com Horticultural Division 930 Jimmy Ann Drive Daytona Beach, FL 32117 Phone: 1-386-274-5566 Fax: 1-386-274-5599
Europe	
SATO INTERNATIONAL EUROPE N.V. (Regional HQ) Leuvensesteenweg 369, 1932 Sint-Stevens-Woluwe, Brussels, Belgium Phone: 32(0)-2-788-80-00 Fax: 32(0)-2-788-80-80 Email: info@be.sato-europe.com	SATO UK LTD Valley Road, Harwich, Essex England Co12 4RR, United Kingdom Phone: 44-1255-240000 Fax: 44-1255-240111 Email: enquiries@sato-uk.com
SATO LABELLING SOLUTIONS EUROPE GmbH Ersheimer Straße 71, 69434 Hirschhorn, Germany Phone: 49-6272-9201-324 Fax: 49-6272-9201-399	SATO POLSKA SP Z O.O. Ul. Wroclawska 123, 55-015 Radwanice K/Wroclawia, Poland Phone: 48-71-381-03-60 Fax: 48-71-381-03-68 Email: info@sato-europe.com
SATO FRANCE SAS Parc D'Activites - Rue Jacques Messager - 59175 Templemars, France Phone: 33-3-20-62-96-40 Fax: 33-3-20-62-96-55	SATO IBERIA S.A. Dels Coralls Nous, 35-39, Pol. Can Roqueta, 08202 - Sabadell, Barcelona, Spain Phone: 34-93-492-5750 Fax: 34-93-786-3451
Asia Pacific & Oceania	
SATO INTERNATIONAL ASIA PACIFIC PTE. LTD. (Regional HQ) 438A Alexandra Road #05-01/04, Alexandra Technopark, Singapore 119967 Phone: 65-6271-5300 Fax: 65-6273-6011 Email: sales@sato-int.com	SATO AUTO-ID MALAYSIA SDN. BHD. No.25, Jalan Pemberita U1/49, Temasya Industrial Park Section U1, 40150 Shah Alam, Selangor Darul Ehsan, Malaysia Phone: 60-3-7620-8901 Fax: 60-3-5569-4977 Email: sales@satosms.com.my
SATO ASIA PACIFIC PTE. LTD. 438A Alexandra Road #05-01/04, Alexandra Technopark, Singapore 119967 Phone: 65-6271-5300 Fax: 65-6273-6011 Email: sales@satoasiapacific.com	SATO AUTO-ID (THAILAND) CO., LTD. 292/1 Moo 1 Theparak Road, Tumbol Theparak, Amphur Muang, Samutprakarn 10270 Phone: 662-736-4460 Fax: 662-736-4461
SATO SHANGHAI CO., LTD. 307 Haining Road, ACE Bldg, 10th Floor, Hongkou Area, Shanghai, China 200080 Phone: (86) 021-63068899 Fax: (86) 021-63091318	SATO AUSTRALIA PTY LTD. 1/1 Nursery Avenue, Clayton Business Park (1508 Centre Road) Clayton VIC 3168, Melbourne, Australia Phone: 61-3-8814-5330 Fax: 61-3-8814-5335
SATO NEW ZEALAND LTD 30 Apollo Drive, Mairangi Bay PO Box 305-031, North Shore, Auckland, New Zealand Phone: 64-9-477-2222 Fax: 64-9-477-2228	For a full list of all SATO offices, refer to www.satoworldwide.com

TABLE OF CONTENTS

INTRODUCTION

About This Manual	1-2
General Description	1-3
Control Features	1-4

TECHNICAL DATA

Physical Characteristics	2-2
Environmental	2-2
Power	2-2
Processing	2-2
Command	2-2
Interface Modules	2-2
Print	2-2
Sensing	2-3
Media	2-3
Ribbon	2-3
Regulatory	2-3
Character Font Capabilities	2-4
Barcode Capabilities	2-5

INSTALLATION

Unpacking & Parts Identification	3-2
Printer Installation	3-3
Site Location	3-3
Cable Connection	3-3
Media Selection	3-4
Media & Ribbon Loading	3-4
Operational Mode Selection	3-6
Continuous Mode	3-6
Tear-Off Mode	3-6
Cutter Mode	3-6
Dispense Mode	3-6
Linerless Mode	3-6
Interface Selection	3-8
RS232C High-Speed Serial Interface	3-8
IEEE1284 Parallel Interface	3-10
Universal Serial BUS (USB) Adapter	3-11
Local Area Network (LAN) Ethernet	3-11
802.11G Wireless	3-12
All Interfaces	3-14
Accessories Installation	3-22
Interface Installation	3-22
Flash Memory Card	3-22

PRINTER CONFIGURATION

Printer Configuration	4-2
Configuration Modes	4-3
User Mode	4-3
Configuration Mode	4-4
Advanced Mode	4-5
Serial Interface Mode	4-7
Parallel Interface Mode	4-8
Centronics Interface Mode	4-9
Universal Serial BUS (USB) Interface Mode	4-10
Local Area Network (LAN) Interface Mode	4-11
Wireless Local Area Network (WLAN) Interface Mode	4-12
PGL Emulation Mode	4-13
ZGL Emulation Mode	4-14
DGL Emulation Mode	4-15
TGL Emulation Mode	4-16
IGL Emulation Mode	4-17
Diagnostics Mode	4-18
Printer Management Mode	4-19
Misc Quick Menus	4-20
Display Intensity Adjustment	4-20
Buffer Clear	4-20
Soft Reset	4-21
Key Lock/Unlock	4-21
Menu Definition Tables	4-22
User Mode	4-22
Configuration Mode	4-26
Advanced Mode	4-29
Serial Interface Mode	4-39
Parallel Interface Mode	4-44
Centronics Interface Mode	4-47
Universal Serial BUS (USB) Interface Mode	4-50
Local Area Network (LAN) Interface Mode	4-52
Wireless Local Area Network (WLAN) Interface Mode	4-56
PGL Emulation Mode	4-63
ZGL Emulation Mode	4-69
DGL Emulation Mode	4-72
TGL Emulation Mode	4-75
IGL Emulation Mode	4-78
Diagnostics Mode	4-82
Printer Management Mode	4-85
Misc Quick Menus	4-88
Display Intensity Adjustment	4-88
Buffer Clear	4-88
Soft Reset	4-88
Key Lock/Unlock	4-88

TROUBLESHOOTING

Error Signal Troubleshooting	5-2
Troubleshooting Table	5-8
Interface Troubleshooting	5-10
Parallel Interface	5-10
RS232 Serial Interface	5-10
Universal Serial Bus (USB) Interface	5-10
LAN Ethernet Interface	5-11
802.11G Wireless Interface	5-11
Centronics Interface	5-11
Test Print Troubleshooting	5-12
Hex Dump Mode	5-12
Test Label Printing	5-12
Sample Test Label	5-13

MAINTENANCE

Cleaning Procedures	6-2
Replacement Procedures	6-3
Print Head	6-3
Fuse	6-4
Media Platen Roller	6-5
Adjustment Procedures	6-6
Label Sensor Positioning	6-6
Print Head Balance	6-7
Print Head Pressure	6-8
Print Head Alignment	6-9
Ribbon Guide	6-10
Ribbon Roller Alignment	6-11

1

INTRODUCTION

- **About This Manual**
- **General Description**
- **Control Features**

ABOUT THIS MANUAL

This manual is laid out consistent with the product discussed and provides all of the information required for printer installation, configuration, operation, and light maintenance. Refer to this product's Programming Reference document for instructions on printer programming through a host system.

This manual also incorporates the use of special information boxes. Examples of these boxes and the type of information provided in each, are below.

WARNING: PROVIDES INFORMATION THAT, IF UNHEEDED, MAY RESULT IN PERSONAL INJURY.

CAUTION: PROVIDES INFORMATION THAT, IF UNHEEDED, MAY RESULT IN EQUIPMENT DAMAGE.

ATTENTION: Provides information that is deemed of special importance but will not result in personal injury or product damage if unheeded.

NOTE: Provides helpful hints to assist in performing the tasks at hand.

LCD DISPLAY: Provides the specific display that should be visible on the LCD at that point.

A comprehensive Table Of Contents provided at the front of this manual facilitates rapid movement within. The contents identify the different Units, Chapters, and some Sections. Each references the page number of their commencement.

The pages of this manual have embedded headers and footers to assist the user in identifying his or her exact position within the manual. The header provides the unit number followed by its name. The footer identifies the product on the left, the page number in the center, and the manual's part number to the right side of the page.

Page enumeration is two-part with each separated by a hyphen. The first character set references the Unit and the second identifies the page number within that unit. Page numbers begin with the numeral one (1) at the beginning of a new unit and ascend sequentially.

GENERAL DESCRIPTION

The GL4e Series printers are specifically designed for use in high-volume, labeling applications demanding great reliability and around the clock operation. It's aluminum chassis provides the needed corrosion resistance demanded by some industrial applications. The coated interior frame provides strength and stability.

The stylish front housing cover and operator panel are both molded of extra-durable, black ABS plastic to not only provide protection against corrosive chemicals; but to also provide a low-show, easy clean surface for unsightly grim.

This printer model has the attractiveness desired for commercial applications coupled with the muscle expected of an industrial printer.

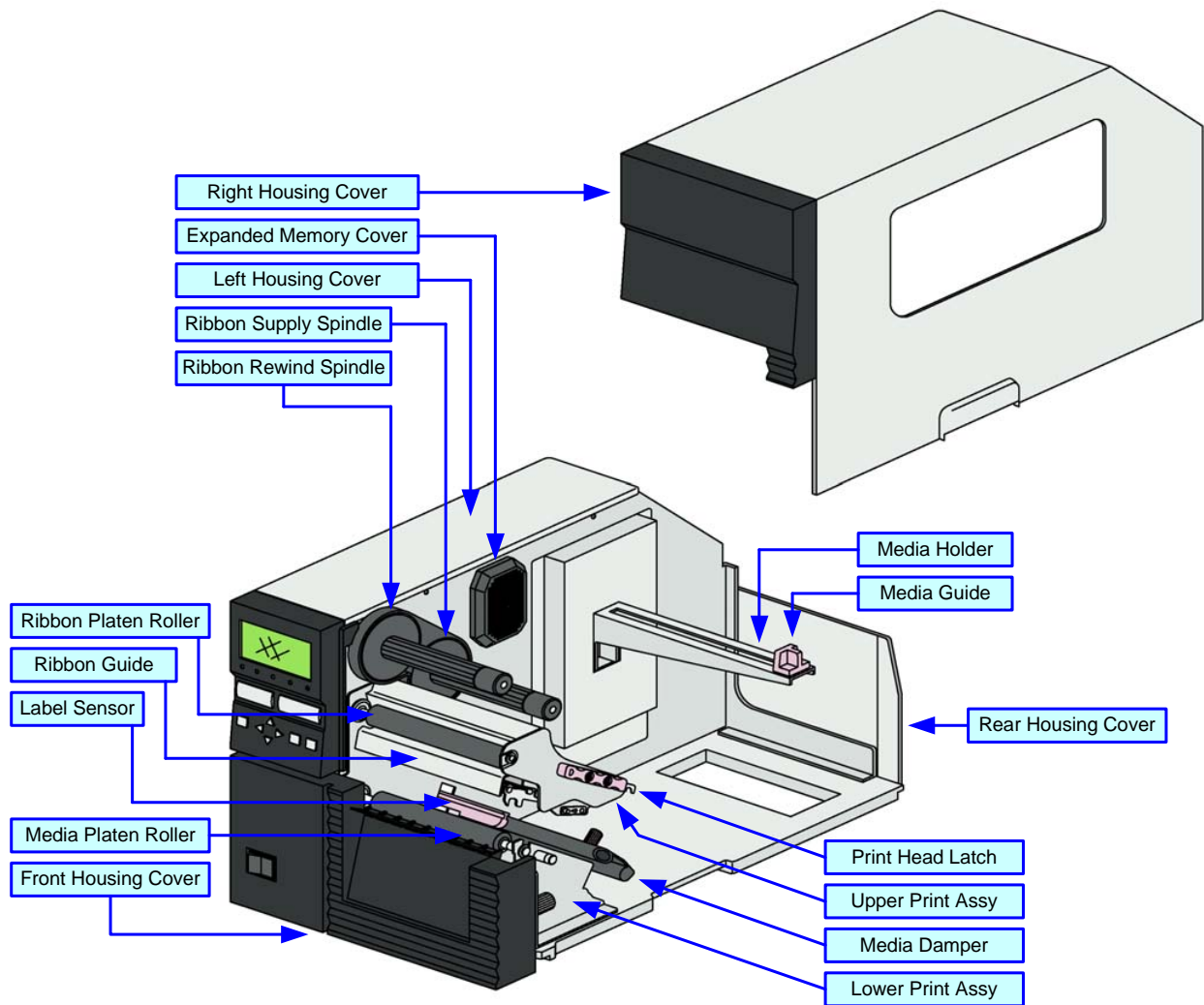

Figure 1-1, Primary Components

CONTROL FEATURES

This chapter identifies the interactive control features of the printer. These functions are defined generally here. More specific explanations will be found throughout this manual on how to use them.

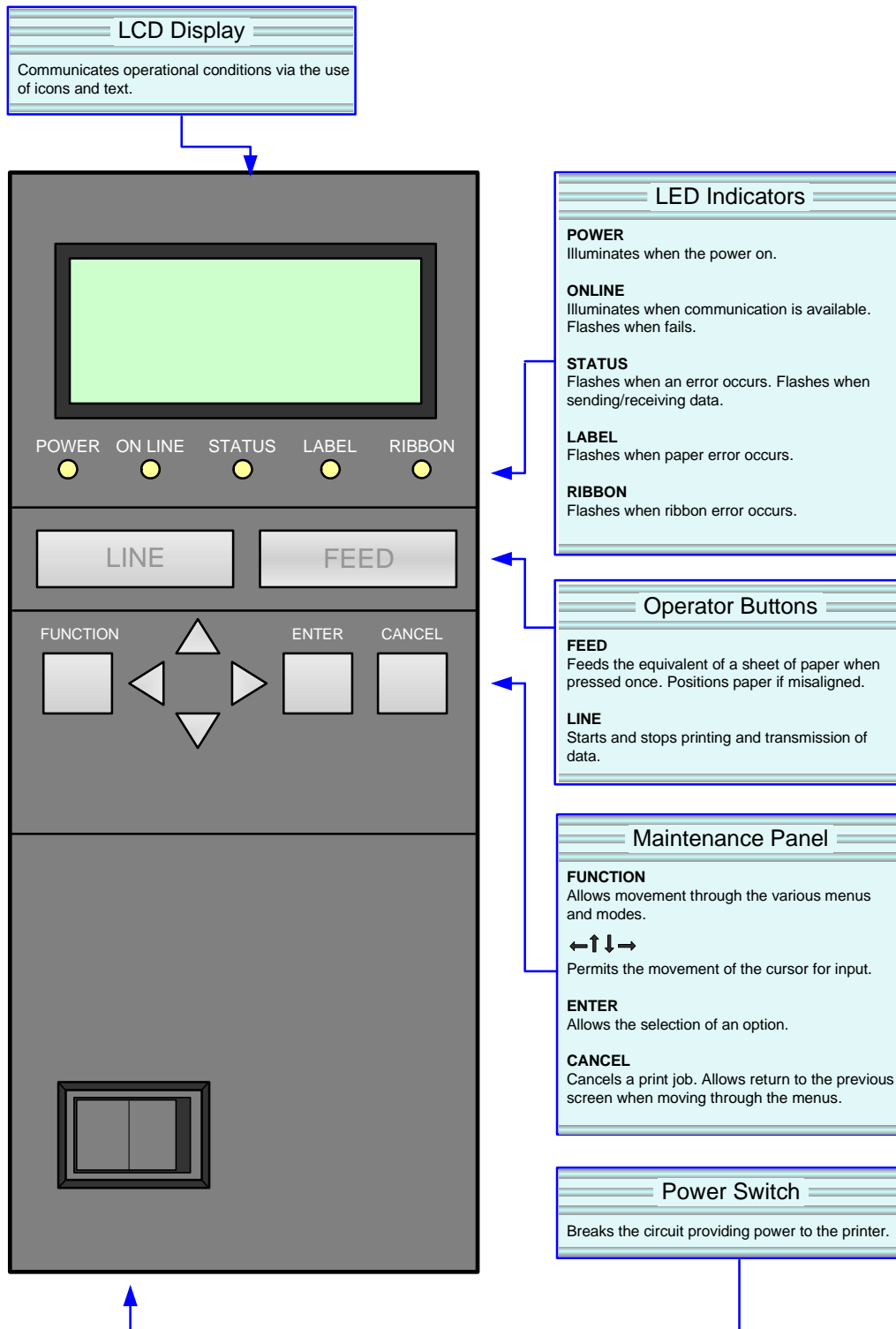

Figure 1-2, Operator Panel

2

TECHNICAL DATA

- **Physical Characteristics**
- **Environmental**
- **Power**
- **Processing**
- **Command**
- **Interface Modules**
- **Print**
- **Sensing**
- **Media**
- **Ribbon**
- **Regulatory Approvals**
- **Character Font Capabilities**
- **Barcode Capabilities**

Unit 2: Technical Data

PHYSICAL CHARACTERISTICS

Width	10.75 Inches (271 mm)
Height	12.00 Inches (305 mm)
Depth	18.00 Inches (455 mm)
Weight	33 Pounds (15 Kg)

ENVIRONMENTAL

Operating Temperature	41 to 104°F (5° to 40°C)
Storage Temperature	-4 to 140°F (-20° to 60°C)
Storage Humidity	15 to 85% RH Non-Condensing
Operating Humidity	15 to 85% RH Non-Condensing

POWER

Input Voltage	100-120/200-240 Volts AC +/- 10%, 50/60 Hertz +/-5%
Consumption Voltage	Maximum: 222 Volts AC, 219 Watts (when print ratio is 50%) Standby: 22.3 Volts AC, 20.6 Watts

PROCESSING

CPU	32 Bit RISC
Flash ROM	8 Megabytes
Receive Buffer	2.95 Megabytes maximum, 0.95 Megabytes near full

COMMAND

Standard	SATO Barcode Printer Language (SBPL) Intelligent Command
Non-Standard	N/A

INTERFACE MODULES

Enhanced Parallel Port	IEEE1284 (EPC compatible)
Serial Port	9-Pin RS232C
Universal Serial Bus (USB)	USB Adapter (480 Mbps)
Local Area Network (LAN)	10BASE-T/100BASE-TX Automatic Switching
Ethernet (Wireless LAN)	802.11g Wireless Wi-Fi

PRINT

Method	Direct Thermal / Thermal Transfer
Maximum Speed (selectable)	2, 3, 4, 5, 6, 7, 8, 9, 10 Inches Per Second (50.8 - 254 mm)
Print Module (dot size)	.0049 Inches (.125 mm)
Resolution	GL408e: 203 Dots Per Inch (8 dpmm) GL412e: 305 Dots Per Inch (12 dpmm)
Maximum Print Width	4.09 Inches (104 mm)
Maximum Print Length	98.98 Inches (2514 mm)

Unit 2: Technical Data

SENSING	
Gap	Position & Sensitivity Adjustable
Reflective Eye-Mark	Position & Sensitivity Adjustable
Ribbon Near End	Fixed (enabled/disabled)
Media Out	Fixed (always enabled)
Ribbon Out	Fixed (always enabled)
Cover Open	Fixed (always enabled)

MEDIA	
Width	Media Width: 0.87 to 5.04 Inches (22 - 128mm) Media Width with Backing Paper: 0.98 to 5.16 Inches (25 - 131mm)
Length (Continuous)	Media Length: 0.24 to 15.63 Inches (6 - 397mm) Media Length with Backing Paper: 0.35 to 15.75 Inches (9 - 400mm)
Length (Tear-Off)	Media Length: 0.67 to 15.63 Inches (17 - 397mm) Media Length with Backing Paper: 0.79 to 15.75 Inches (20 - 400mm)
Type	Roll or Fan-Fold Eye-Mark or Gap Direct Thermal or Thermal Transfer
Thickness	0.002 to 0.010 Inches (0.06 - 0.268 mm)
Roll Diameter	Maximum: 10.43 Inches (265mm)
Core Diameter	1.5 to 4.0 Inches (38.1 - 101.6mm)
Wind Direction	Face In, Face Out (linerless only)
Fan-Fold Height	Maximum: 7.87 Inches (200mm)

RIBBON	
Width	Maximum: 5.04 Inches (128mm)
Length	1476 Feet (450M)
Wound	Face In, Face Out
Core Diameter	1.00 Inch (25.6 mm)
Roll Diameter	Maximum: 3.35 Inches (85 mm)

REGULATORY	
Radiation Noise	FCC Part 15, Subpart B, Class B EN55022 Class B
Static Electricity	IEC61000-4-2, Level 3
AC Line Noise	Above: 1000Vp-p
Packing Drop Standard	ISTA-2A
Environmental (RoHS)	Chromium: below 0.1% Lead: below 0.1% Mercury: below 0.1% Cadmium: below 0.01% Polybrominated Biphenyl (PBB): below 0.1% Polybrominated Diphenyl Ether (PBDE): below 0.1%

CHARACTER FONT CAPABILITIES	
MATRIX FONTS	
XU	5 dots W x 9 dots H (Helvetica)
XS	17 dots W x 17 dots H (Univers Condensed Bold)
XM	24 dots W x 24 dots H (Univers Condensed Bold)
OA Font (OCR-A)	GL408e: 15 dots W x 22 dots H GL412e: 22 dots W x 33 dots H
OB Font (OCR-B)	GL408e: 20 dots W x 24 dots H GL412e: 30 dots W x 36 dots H
AUTO SMOOTHING FONTS	
XB	48 dots W x 48 dots H (Univers Condensed Bold)
XL	48 dots W x 48 dots H (Sans Serif)
VECTOR FONT	
	Proportional or Fixed Spacing Font Size 50 x 50 dots to 999 x 999 dots Helvetica, 10 Font Variations
AGFA RASTER FONTS	
A Font	CG Times, 8 to 72 pt.
B Font	CG Triumvirate, 8 to 72 pt.
DOWNLOADABLE FONTS	
	N/A
CHARACTER CONTROL	
	Expansion up to 12 x in either the X or Y coordinates. Character Pitch Control Line Space Control Journal Print Facility 0, 90, 180, and 270 Degree Rotation

Unit 2: Technical Data

BARCODE CAPABILITIES	
Linear Bar Codes	UPC A/E JAN 8/13 EAN 8/13 Code 39 Code 93 Code 128 Interleaved 2 of 5 Industrial 2 of 5 Matrix 2 of 5 Bookland NW-7 MSI RSS-14 POSTNET UCC/EAN 128 Customer Barcode
Two Dimemsional	QR Code Data Matrix Maxi Code PDF417 Micor PDF417 Synthetic Symbol
Ratios	1:2, 1:3, 2:5, User definable bar widths
Bar Height	4 to 999 dots, User programmable
Rotation	0, 90, 180, and 270 Degrees
Sequential Numbering	Sequential numbering of both numerics and bar codes
Expansion Ratio of Character	Height: 1 to 12 times, Width: 1 to 12 times
Graphics	Full dot addressable graphics, SATO Hex/Binary, BMP or PCX formats
Form Overlay	Form overlay for high-speed editing of complex formats

3

INSTALLATION

- **Unpacking & Parts Identification**
- **Printer Installation**
- **Operational Mode Selection**
- **Interface Selection**
- **Accessories Installation**

UNPACKING & PARTS IDENTIFICATION

Unpack the printer as directed in the following procedure.

- 1 Place the shipping container (box) upright on a solid, flat surface.
- 2 Open the box, remove any loose items and the first layer of packing material.
- 3 Carefully lift the printer and accessories from the box and place them on a solid flat surface.
- 4 Remove the plastic covers from the packed items and visually inspect for physical damage.
- 5 Ensure all components are present as dictated on the Packing List.
- 6 Report damaged property.

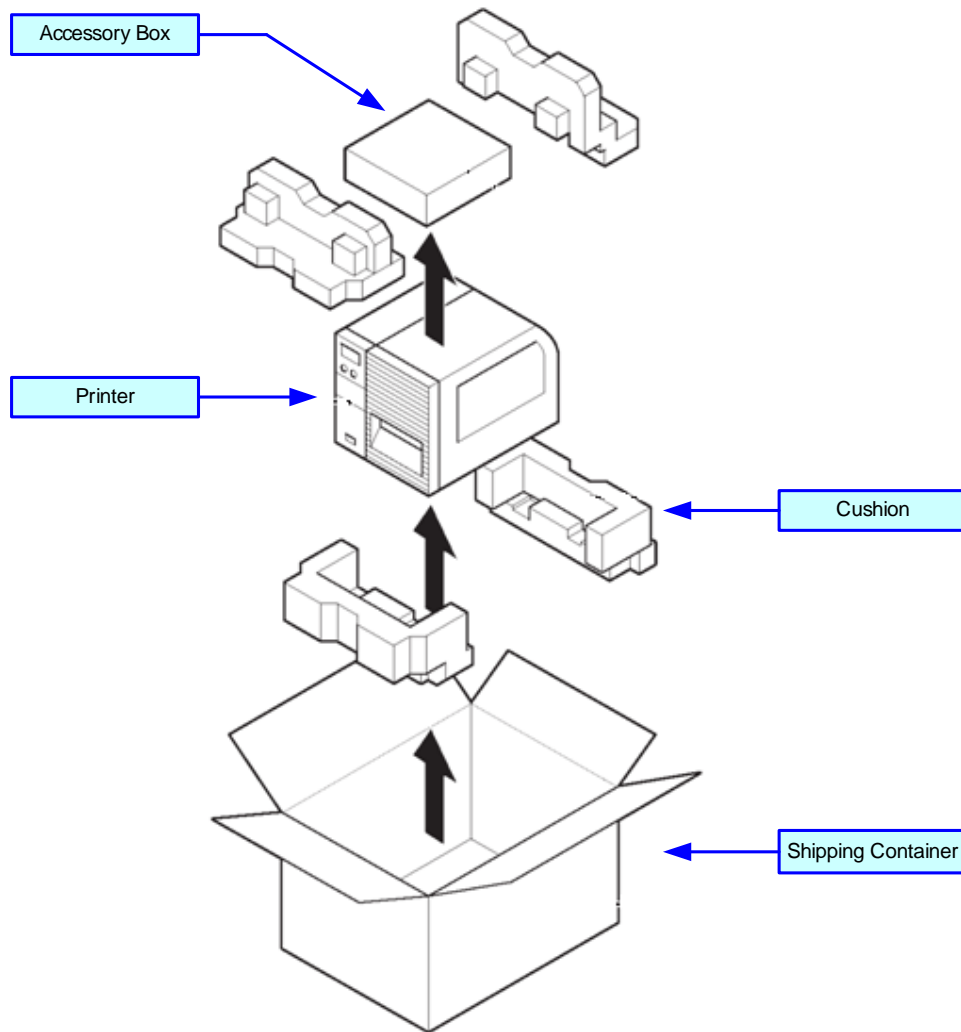

Figure 3-1, Unpacking & Parts Identification

PRINTER INSTALLATION

This chapter provides guidance on how to station, connect, and load the printer once unpacked. Following printer setup, proceed to the next chapter for information on interface selection.

SITE LOCATION

- Stationed on a solid flat surface.
- Stationed away from hazardous materials.
- Stationed within operational distance of the host based on interface specifications.

CABLE CONNECTION

The diagram below (Figure 3-2) displays the printer's connectors and ports for power supply and host interfacing. For interfacing, choose the desired method and connect its respective cable as indicated.

All interface boards are integrated except the LAN/WLAN board. This will have to be installed as shown.

When the interface cable is connected, or the board is installed, the interface option will display in the configuration menu of the operator panel. Refer to the Configuration unit of this manual to configure the printer for host computer interfacing.

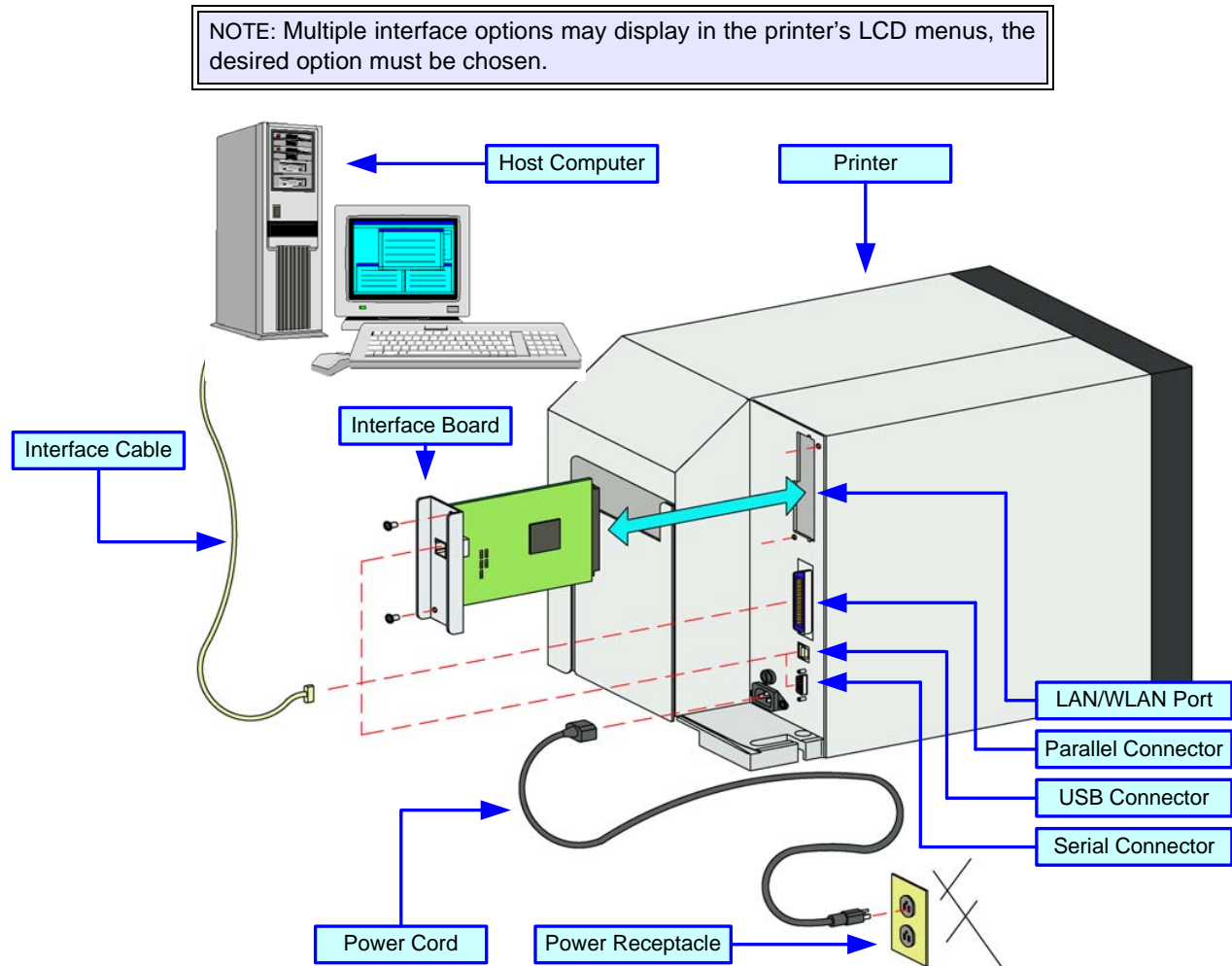

Figure 3-2, Cable Connection Diagram

MEDIA SELECTION

The size and type of the labels or tags to be printed should have been taken into consideration before printer purchase. Ideally, the media width will be equal to, or just narrower than, the print head. Using media that does not cover the print head will allow the platen roller to tread on it and wear it out. The media edge will also wear a groove in the platen roller affecting print quality.

MEDIA & RIBBON LOADING

There are two general media types that may be loaded and used; rolled and fan-folded. Each of those types may again be defined by whether their print application is direct thermal or thermal transfer. Those factors determine how the media is loaded and if ribbon stock is loaded at all.

Thermal transfer media requires the use of ribbon stock for print application. In such a scenario, it is the ribbon stock (carbon paper) that contains the ink that will be transferred to the media.

Direct thermal media has a coating on the surface that is made visible through the application of heat from the print head.

Rolled media of standard diameter is loaded within the printer and suspended by the media holder. Larger, non-standard rolled media would be suspended outside the printer at its rear and fed inward. Fan-folded media would also be fed inward from the rear over the rear housing cover, but is stacked as opposed to suspended.

Refer to Figures 3-3a and 3-3b for proper media routing relative to the type to be used. If that to be used is direct thermal, ignore the ribbon stock in the figures and do not load.

Ribbon can be wound in or wound out.

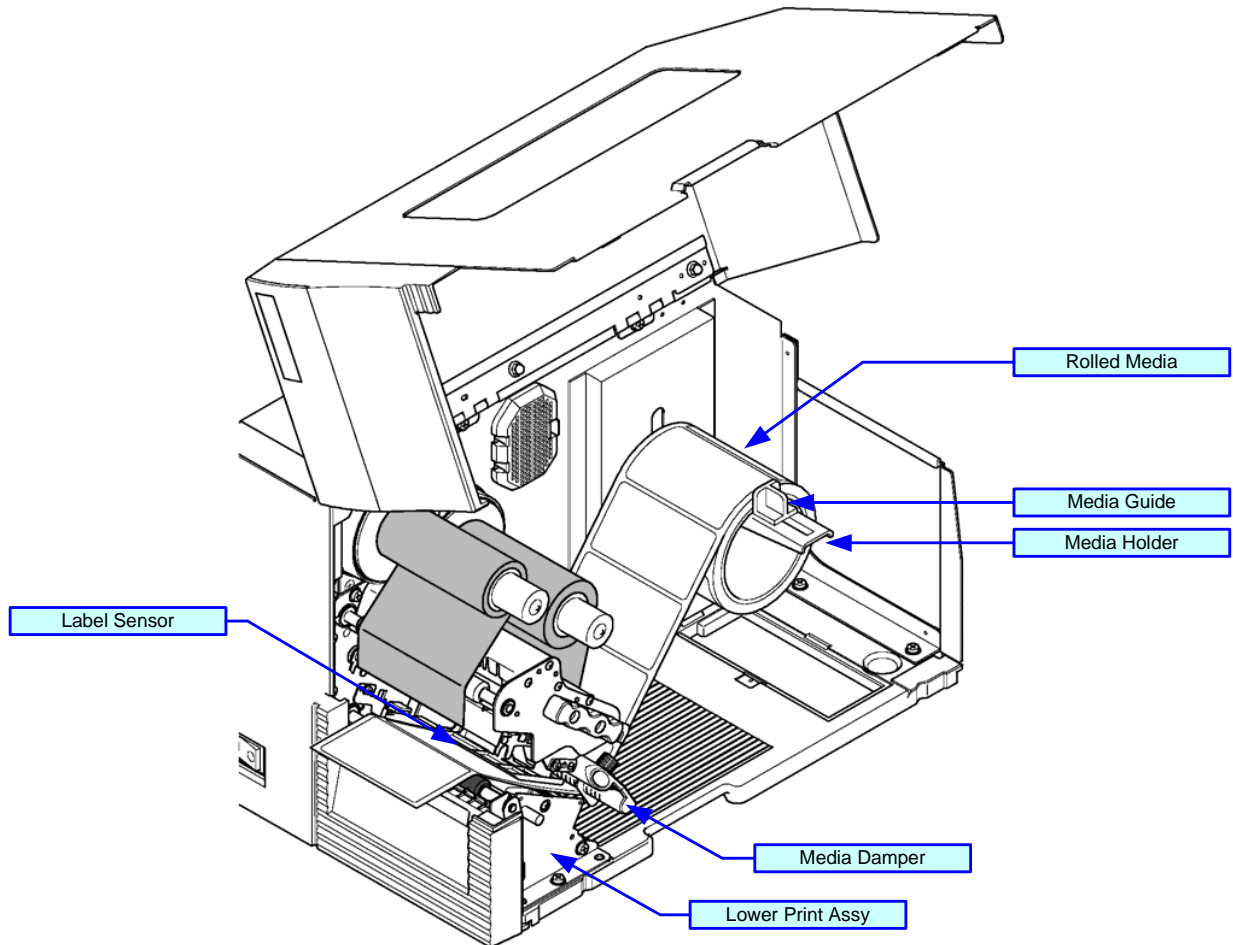

Figure 3-3a, Rolled Media Loading

Unit 3: Installation

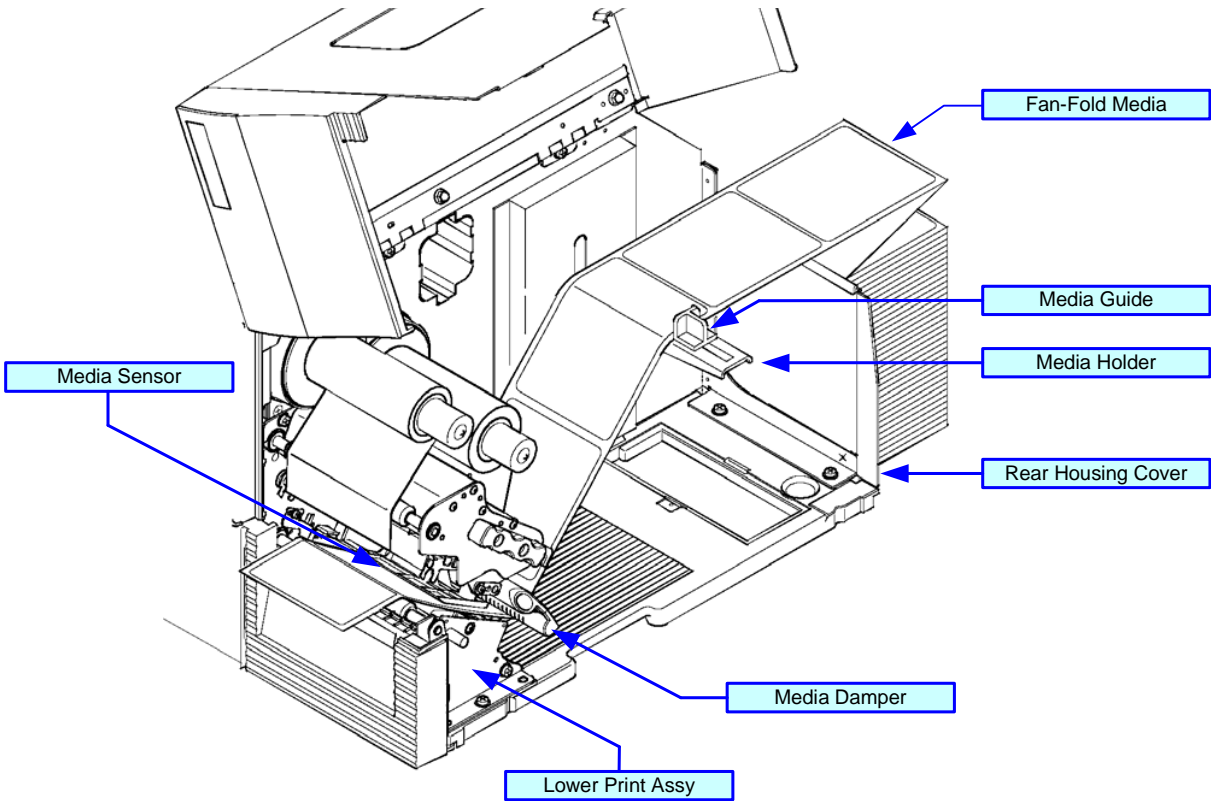

Figure 3-3b, Fan-fold Media Loading

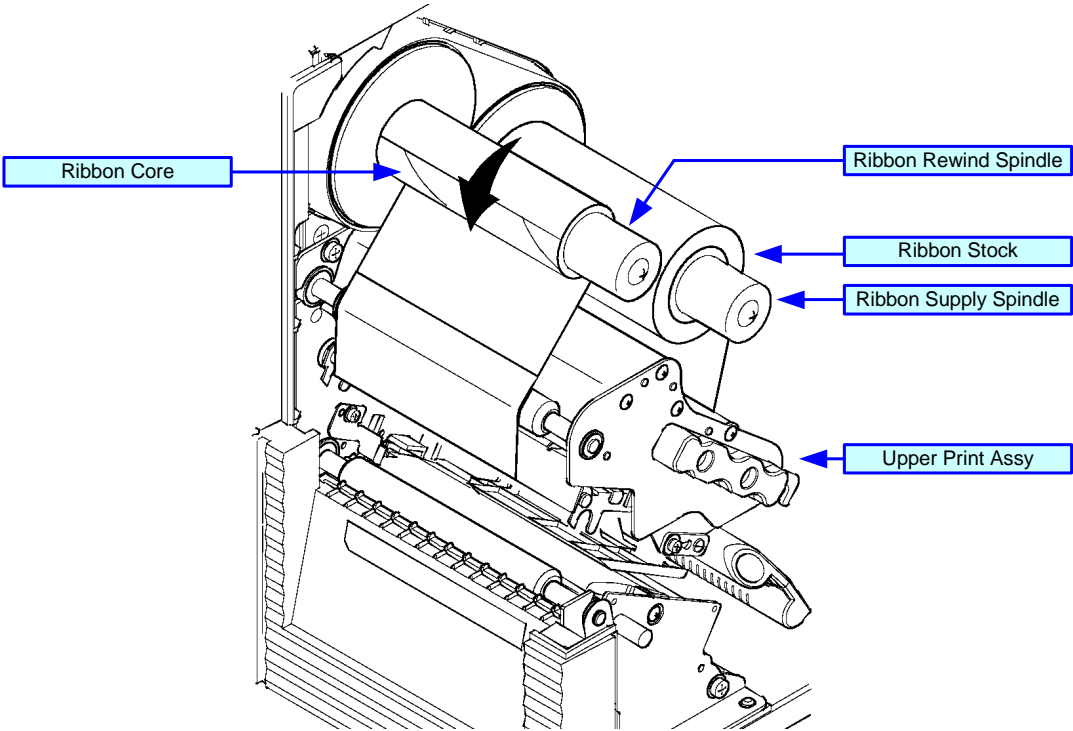

Figure 3-3c, Ribbon Loading

OPERATIONAL MODE SELECTION

There are two modes of printer operation; Dispense and Continuous. The difference between the two is the way that the label and paper backing is ejected. Before printer configuration, one must determine which mode will be used. This chapter identifies the functional differences between the two.

ATTENTION: Refer to the Printer Configuration unit of this manual to program the printer's internal memory to suit individual needs using the integrated menu options. Refer to the Programming Reference document to remotely program the printer's features and functions through a host system.

CONTINUOUS MODE

With this mode of operation, the media remains in position for printing at all times. To do so, means that the previous printed label is only available for removal when one to four additional labels have been printed (quantity is depended on label size). This mode of operation is specifically suited for printing bulk quantities to be applied later.

TEAR-OFF MODE

With this method of operation, after printing, the printer feeds the first (outermost) label so that it is fully extended out of the printer's front for removal. Printing of the next label will not begin until the prior printed label has been removed. This mode of operation is specifically suited for immediate application at the time of print.

Upon removal of the prior printed label, the printer retracts the media so that the next label in line may be printed, then prints. This cycle, repeats for each consecutive label.

CUTTER MODE

With the cutter assembly installed and enabled, this mode of operation will cut individual printed labels or in multiples. The media will be advanced to the cutter blade, the label cut will occur, and the unprinted media will retract for positioning of the next print.

DISPENSE MODE

When the dispenser assembly is installed and enabled, this mode of operation will peel the paper backing from the printed label as it is advanced to the printer's front. Once the printed label has been removed from the printer for application, the unprinted media will retract and position itself so the next label may be printed.

This operational mode is specifically applicable to print operations where the label is to be immediately adhered.

LINERLESS MODE

When the linerless option is installed and enabled, this mode of operation allows for the feeding and printing of linerless media. In this mode, the printer's functionality is the same as with the continuous or tear-off modes - depending on configuration settings.

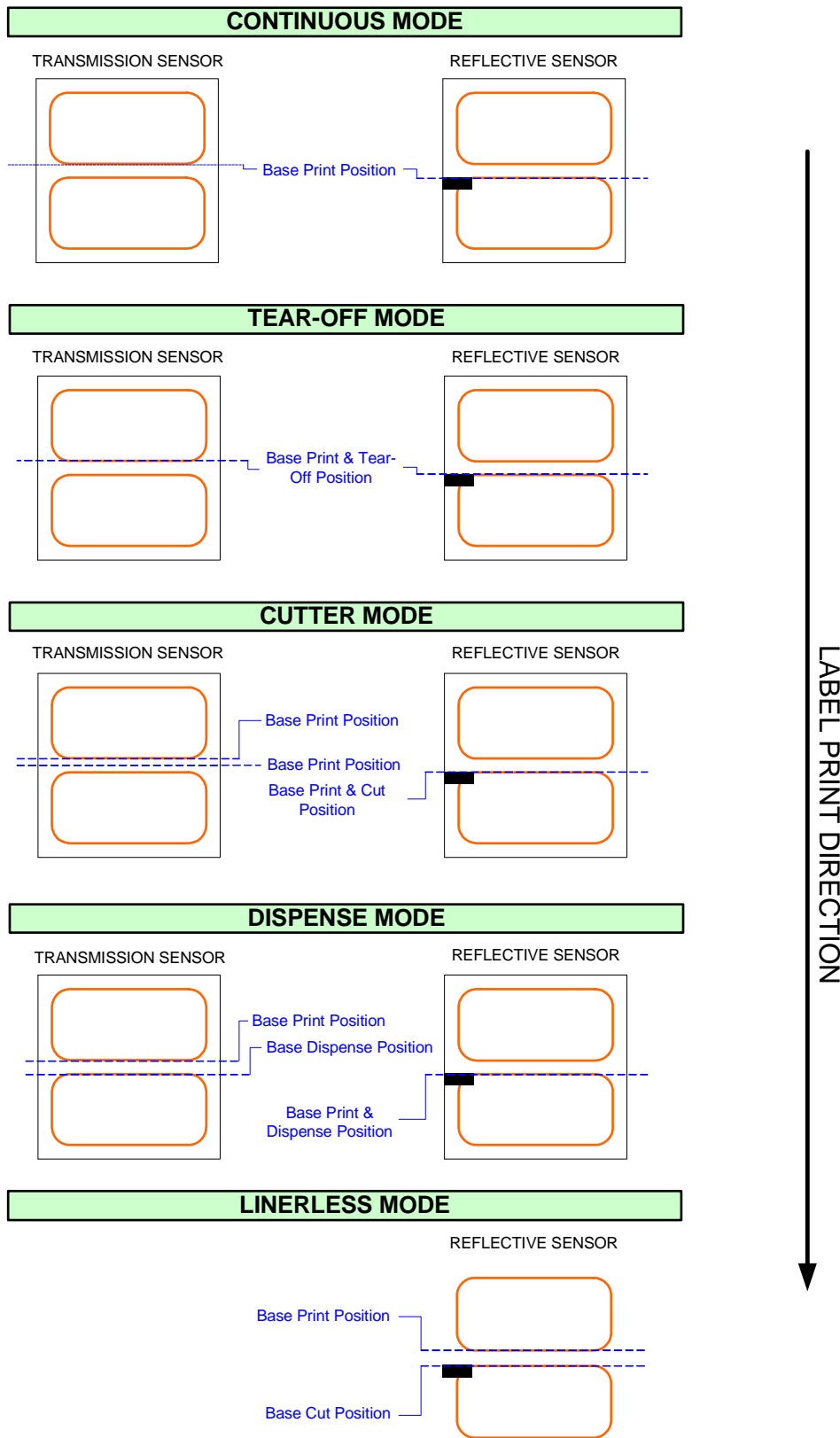

Figure 3-4, Label Reference Position

INTERFACE SELECTION

This unit presents the printer interface types and their specifications. These specifications include detailed information to assist in the selection of the most appropriate method for the printer to interface with the host. The five acceptable interface methods are:

- RS232C High-Speed Serial
- IEEE1284 Parallel
- Universal Serial Bus (USB)
- Local Area network (LAN) Ethernet
- 802.11g Wireless

Following the selection of the desired interface, proceed to the next unit for instructions on how to configure the printer for that interface type.

WARNING: NEVER CONNECT OR DISCONNECT INTERFACE CABLES (OR USE A SWITCH BOX) WITH POWER APPLIED TO EITHER THE HOST OR THE PRINTER. THIS MAY CAUSE DAMAGE TO THE INTERFACE CIRCUITRY IN THE PRINTER/HOST AND IS NOT COVERED BY WARRANTY.

RS232C HIGH-SPEED SERIAL INTERFACE

INTERFACE SPECIFICATIONS	
Asynchronous ASCII	Half-duplex communication Bi-Directional Communication
Data Transmission Rate	600, 1200, 2400, 4800, 9600, 19200, 38400, 57600, 115200 bps
Transmission Form	Start, b1, b2, b3, b4, b5, b6, b7, b8, Stop (b8 will be omitted if using 7 bit oriented)
Data Length	7 or 8 bit (selectable)
Stop Bit	1 or 2 bit (selectable)
Parity Bit	ODD, EVEN, NONE (selectable)
Codes Used	ASC II Character Codes: 7 bits, Graphics: 8 bits
Control Codes	STX (02H), ETX (03H), ACK (06H), NAK (15H)
Connector (Printer Side)	DB-9 Male (equivalent), 9-pin Serial Interface (PCI)
Cable Connector	DB-9 Female (equivalent), 9-pin Serial Interface (PCI)
Cable Length	5 meters or less.
Signal Levels	High = +5V to +12V, Low = -5V to -12V
Protocol	Ready/Busy, X-On/X-Off, Protocol for Driver, Status2, Status3, Status4, Status5

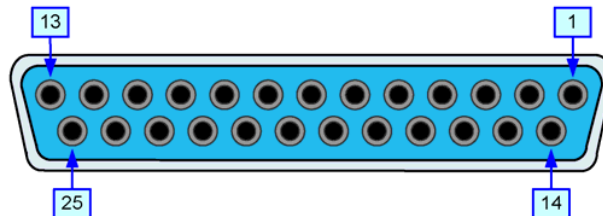

Figure 3-5, Serial Connector Pin Assignments

READY/BUSY INTERFACE SIGNALS	
SIGNAL	SIGNAL DEFINITION
FGN	(Frame Ground)
TxD	(Transmit Data) - Data from the printer to the host computer. Sends X-On/X-Off characters or status data (bi-directional protocols).
RxD	(Receive Data) - Data to the printer from the host computer.
RTS	(Request To Send) - Used with Ready/Busy flow control to indicate an error condition. RTS is high and remains high unless the print head is open (in this case, RTS would return to the high state after the print head is closed and the printer is placed back online) or an error condition occurs during printing (e.g., ribbon out, label out).
CTS	(Clear To Send) - When this line is high, the printer assumes that data is ready to be transmitted. The printer will not receive data when when the line is low. If not being used, it is to be tied high.
DSR	(Data Set Ready) - When this line is high, the printer will not receive data. This line must be high before data is transmitted. If not being used, it is to be tied high.
SGN	(Signal Ground)
DTR	(Data Terminal Ready) - This signal applies to Ready/Busy flow control. The printer is ready to receive data when this pin is high. It goes low when the printer is offline, either manually or due to an error condition, and while printing in the single-job buffer mode. It will also go low when the data in the buffer reaches the buffer near-full level.

READY/BUSY CABLE REQUIREMENTS				
DB9	HOST	DIRECTION	DB9	PRINTER
--	FGN (Frame Ground)	Bi-Directional	--	FGN (Frame Ground)
3	TxD (Transmit Data)	To Printer	2	RxD (Receive Data)
2	RxD (Receive Data)	To Host	3	TxD (Transmit Data)
6	DSR (Data Set Ready)	To Printer	4	DTR (Data Terminal Ready)
5	SGN (Signal Ground)	Bi-Directional	5	SGN (Signal Ground)
4	DTR (Data Terminal Ready)	To Host	6	DSR (Data Set Ready)
8	CTS (Clear To Send)	To Printer	7	RTS (Request To Send)
7	RTS (Request To Send)	To Host	8	CTS (Clear To Send)

IEEE1284 PARALLEL INTERFACE

The parallel interface is a plug-in module that can be installed by the user and conforms to IEEE1284 specifications. It automatically detects the IEEE1284 signals and operates in the high speed mode. If the IEEE1284 signals are not detected, it will operate in the slower standard Centronics mode. For this reason, an interface cable and host interface conforming to the IEEE1284 specification must be present to fully utilize the speed capabilities. This interface also operates bi-directionally and can report the status of the printer back to the host.

SPECIFICATIONS	
Printer Connector	AMP 57-40360 DDK (or equivalent)
Cable Connector	AMP 57-30360 DDK (or equivalent)
Cable	1.5 meter or less
Signal Level	High = +2.4V to +5.0V, Low = 0V to -0.4V
Data Stream	<ESC>A .. Job#1 .. <ESC>Z<ESC>A .. Job#n .. <ESC>Z

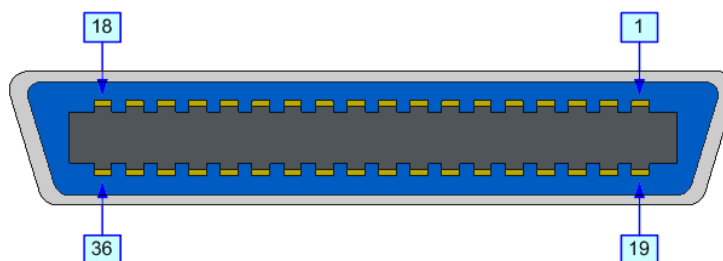

Figure 3-6, Parallel Connector Pin Assignments

PIN ASSIGNMENTS					
PIN	SIGNAL	DIRECTION	PIN	SIGNAL	DIRECTION
1	Strobe	To Printer	19	Strobe Return	Reference
2	Data 1	To Printer	20	Data 1 Return	Reference
3	Data 2	To Printer	21	Data 2 Return	Reference
4	Data 3	To Printer	22	Data 3 Return	Reference
5	Data 4	To Printer	23	Data 4 Return	Reference
6	Data 5	To Printer	24	Data 5 Return	Reference
7	Data 6	To Printer	25	Data 6 Return	Reference
8	Data 7	To Printer	26	Data 7 Return	Reference
9	Data 8	To Printer	27	Data 8 Return	Reference
10	ACK	To Host	28	ACK Return	Reference
11	Busy	To Host	29	Busy Return	Reference
12	Ptr Error	To Host	30	PE Return	Reference
13	Select	To Host	31	INIT	From Host
14	AutoFD ₁	To Host	32	Fault	To Host
15	Not Used		33	Not Used	
16	Logic Gnd		34	Not Used	
17	FG	Frame Gnd	35	Not Used	
18	+5V (z=24k ohm)	To Host	36	SelectIn ₁	From Host

1 Signals required for ieee 1284 mode.

UNIVERSAL SERIAL BUS (USB)

The Universal Serial Bus (USB) interface is a Plug-In Interface Module that can be installed by the user. It requires a driver (shipped with each printer that has the interface installed) that must be loaded onto the PC and configured to support USB peripherals using Windows 2000 or above. Details for loading the USB driver are contained in the USB Interface Manual that is shipped with each printer with a USB Optional interface installed. Up to 127 devices may be connected to a USB port using powered hubs.

ATTENTION: This Interface Type Is Not Compatible With Windows 98 Or Windows Me.

SPECIFICATIONS	
Printer Connector	USB Type B Plug
Cable	10 feet (3 m) maximum
Host	Windows 2000 or above with USB Port
Power Supply	BUS Power through cable
Power Consumption	+5 V at 80 ma

LOCAL AREA NETWORK (LAN) ETHERNET

A Local Area Network (LAN) interface is an optional Plug-In Interface Module that can be installed by the user. It requires a driver shipped with each printer that has the interface installed. The driver that must be loaded onto the host computer and configured to run one of the supported network protocols using a 10Base-T or 100Base-TX LAN connection. Details for loading the LAN driver are contained in the LAN Interface Manual that is shipped with each printer with a LAN Optional interface installed.

SOFTWARE SPECIFICATIONS	
Corresponding Protocol	TCP/IP
Network Layer	ARP, RARP, IP, ICMP
Session Layer	TCP, UDP
Application Layer	LPD, FTP, TELNET, BOOTP, DHCP
<i>NOTE: Print data can be sent by LPR and FTP of TCP/IP and dedicated socket protocol. Printer status is obtainable by dedicated socket protocol.</i>	
<i>NOTE: In the TCP/IP protocol environment, LPD and FTP are provided for printing; TELNET for variable setup; ARP, RARP, and BOOTP/DHCP for address setup.</i>	
<i>LPD protocol complies with RFC1179 and handles the list of logical printer name as queue name such as lp, sjis, euc. In addition, a banner page can be printed by a proper setup.</i>	
<i>When sending the job by LPR, the transmission order of data file/control file within the job will not affect print operation. In addition, if the banner page is specified, it will be added to each data file. Job deletion by LPR is not available.</i>	
<i>FTP protocol complies with RFC959 and handles the list of logical printer name as a transfer directory. File transfer to this directory executes print operation. It is possible to specify ASCII(A), Binary(I) and TENEX(L8) as transfer mode - although the mode difference is dependent on the client. A banner page may be printed with a proper setup.</i>	
<i>TELNET Complies with RFC854. This operation consists of interactive menu form and enables change and reference of internal setup, and to display status. To change the setup, enter "root" user and password at the time of login. Default of root password is set as null (linefeed only).</i>	

Unit 3: Installation

SPECIFICATIONS	
Connector	RJ-45 Receptacle
Cable	10/100BaseT Category 5
Cable Length	100 meters or less
Power Supply	Powered from printer
Protocol	Status3 return Protocol for Driver (cyclic response mode) Protocol for Driver (ENQ response mode) Status5 return
IP Address	0.0.0.0 to 255.255.255.255
Subnet Mask	0.0.0.0 to 255.255.255.255
Gateway Address	0.0.0.0 to 255.255.255.255

802.11G WIRELESS

The wireless print server provides easy printer interface with 802.11g Wi-Fi compliant networks free of wired connections. Each printer is shipped with an integrated driver and interface installed. The driver must be loaded onto the host computer and configured to run one of the supported protocols.

SPECIFICATIONS	
Variable Data Rates	54, 11, 5.5, 2 and 1 Mbps
Frequency Band	2.4 GHz ISM Band
Wired Equivalent Privacy	128 bit, 64 bit (compatible with 40bit), none (WPA)
Sensitivity	(typ. AAWGN, 8E-2 PER): -91dBm at 1Mbps, -88dBm at 2 Mdps, -87dBm at 5.5Mbps, -84dBm at 11Mbps.
Range	100m indoors, 300m outdoors (enviromentally dependent)
Protocols	TCP/IP, IPX/SPX, Direct Mode IPX/IP, DLC/LLC, NetBEUI, NetBIOS/IP
Protocol	Status3 return Protocol for Driver (cyclic response mode) Protocol for Driver (ENQ response mode) Status5 return
IP Address	0.0.0.0 to 255.255.255.255
Subnet Mask	0.0.0.0 to 255.255.255.255
Gateway Address	0.0.0.0 to 255.255.255.255
Communication Mode	Infrastructure
SSID	Optional alphanumeric character string (up to 32 characters)
Channels	01 to 11

LED INDICATOR STATUS			
Link LED (green)	Network Port	Off	---
	Front Panel	Blinking	Waiting for link
		On	Linked
Status LED (orange)	Network Port	Off	---
	Front Panel	Blinking	Receiving packet
Wireless LED (green)	Front Panel	On	Infrastructure mode

WIRELESS LAN SIGNAL STRENGTH			
Network Port	Link LED	Off	0 to 50% (weak)
		Blinking	50 to 75% (medium)
		On	75 to 100% (strong)

SOFTWARE SPECIFICATIONS	
Corresponding Protocol	TCP/IP
Network Layer	ARP, RARP, IP, ICMP
Session Layer	TCP, UDP
Application Layer	LPD, FTP, TELNET, BOOTP, DHCP
NOTE: Print data can be sent by LPR and FTP of TCP/IP and dedicated socket protocol. Printer status is obtainable by dedicated socket protocol.	
NOTE: In the TCP/IP protocol enviroment, LPD and FTP are provided for printing; TELNET for variable setup; ARP, RARP, and BOOTP/DHCP for address setup.	
LPD protocol complies with RFC1179 and handles the list of logical printer name as queue name such as lp, sjis, euc. In addition, a banner page can be printed by a proper setup.	
When sending the job by LPR, the transmission order of data file/control file within the job will not affect print operation. In addition, if the banner page is specified, it will be added to each data file. Job deletion by LPR is not available.	
FTP protocol complies with RFC959 and handles the list of logical printer name as a transfer directory. File transfer to this directory executes print operation. It is possible to specify ASCII(A), Binary(I) and TENEX(L8) as transfer mode - although the mode difference is dependent on the client. A banner page may be printed with a proper setup.	
TELNET Complies with RFC854. This operation consists of interactive menu form and enables change and reference of internal setup, and to display status. To change the setup, enter "root" user and password at the time of login. Default of root pasword is set as null (linefeed only).	

1) Printing by socket (Protocol for driver)

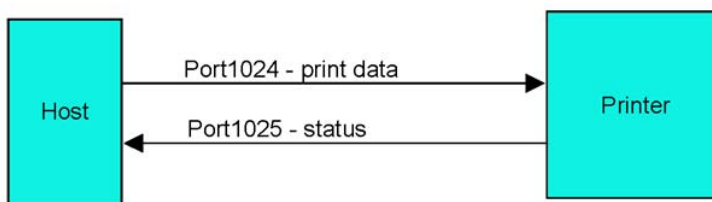

2) Printing by LPR and FTP

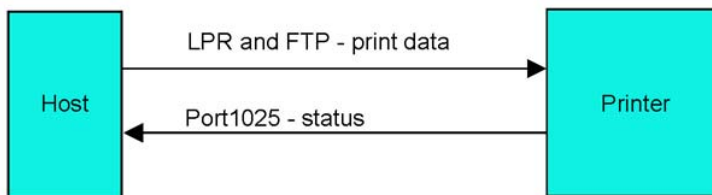

Figure 3-7, Socket Connection Diagram

ALL INTERFACES

Receive Buffer

The data stream is received from the host to the printer one job at a time. This allows the software program to maintain control of the job print queue so that it can move a high priority job in front of ones of lesser importance. A multiple job buffer allows the printer to continuously receive print jobs while compiling and printing other jobs at the same time. It acts much like a Print buffer to maximize the performance of the host and the printer.

The printer receives and prints one job at a time. If a print job exceeds the buffer size, transmission will be rejected by the printer. Error conditions that occur during the Print Data transmission will cause the printer to return a NAK.

ACK/NAK Protocol

Bi-Directional ACK/NAK protocol is used for error control. In a normal transmission sequence when the transmission is received, the printer will return an ACK (06H) signifying that it was received without a transmission error. After the transmission command structure has been analyzed, a status byte is returned to the host. This status byte informs the host of the validity of the command structure.

If the command structure is error free, the printer proceeds with the print operation. When the print operation is completed, a Printer Status message is returned to the host. If an error was detected during the initial transmission sequence, a NAK (15H) will be returned signalling to the host that the received transmission contained errors and must be resent. If the returned Status byte indicates a command structure error, the error must then be corrected before the print data is resent to the printer.

A valid transmission to the printer must be bounded by an STX/ETX pair, with the STX (02H) signifying the start of the Print Data and ending with an ETX (03H) signifying the end.

Status5 Return

This communication protocol is designed for the purpose of monitoring and controlling print data status in the host and featuring various functions.

INTERFACE SIGNALS	
SIGNAL	SIGNAL DEFINITION
FGN	(Frame Ground)
SxD	(Send Data) - Data from the printer to the host.
RxD	(Receive Data) - Data from the host to the printer.
SGN	(Signal Ground)

Note: Depending on the host used, the CS and RS (maintaining at high) may need to be looped on the host side. Refer to host computer documentation for details.

CABLE REQUIREMENTS				
DB9	HOST	DIRECTION	DB9	PRINTER
2	Send Data	To Printer	2	Receive Data
3	Receive Data	To Host	3	Send Data
5	Frame Ground	Bi-Directional	5	Frame Ground

RECEIVE BUFFER CONTROL	
Causes For Receive Buffer Near Full	Occurs when the remaining free space of the buffer drops to 0.95MB of 2.95MB capacity or when the remaining free space is available for storing 50 of 500 items in the history buffer.
Release Of Receive Buffer Near Full	Can be released when the remaining free space rises to 1.95MB or when the remaining free space is available for storing 200 items in the history buffer.

STATUS5 TIMING CHARTS

NORMAL PROCESS

(Figure 3-8a)

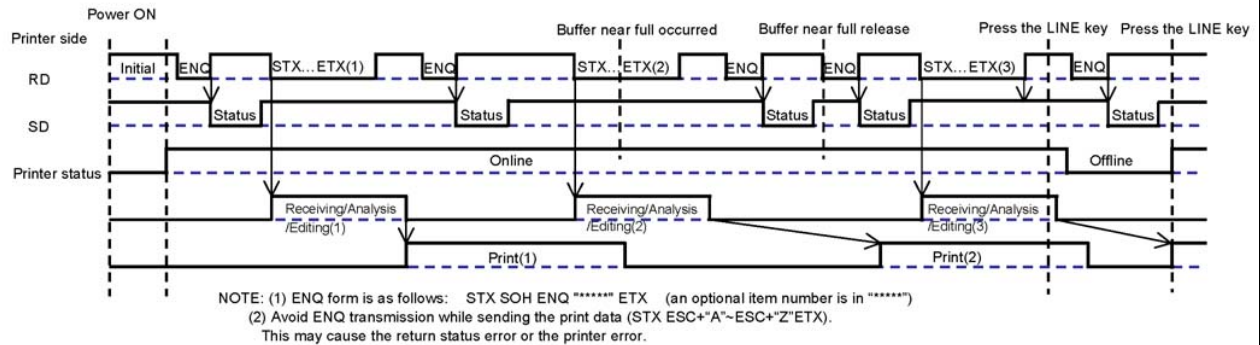

CANCEL PROCESS

(Figure 3-8b)

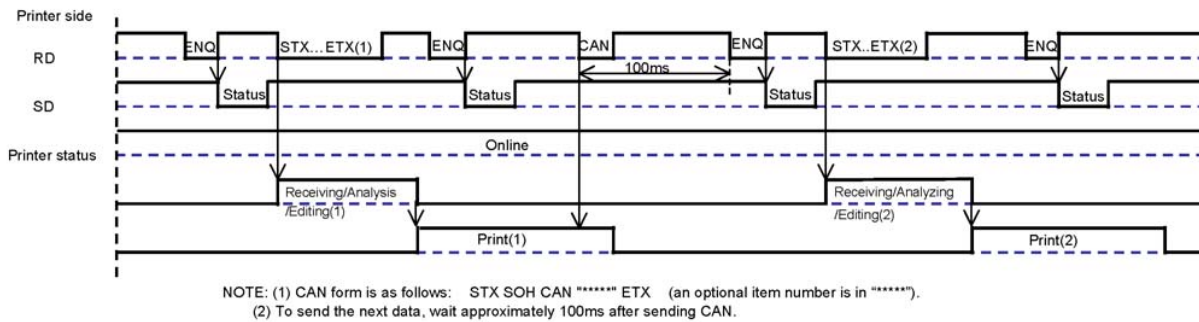

ERROR PROCESS

(Figure 3-8c)

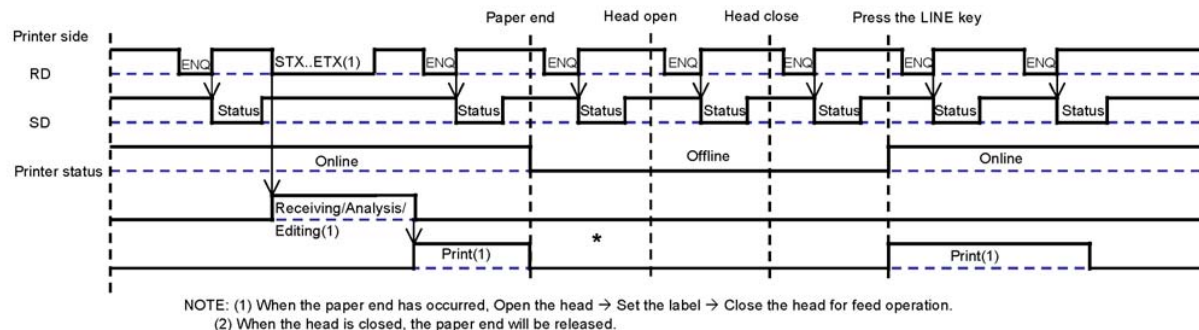

STATUS5 TIMING CHARTS

PRINT PROCESS

(Figure 3-8d)

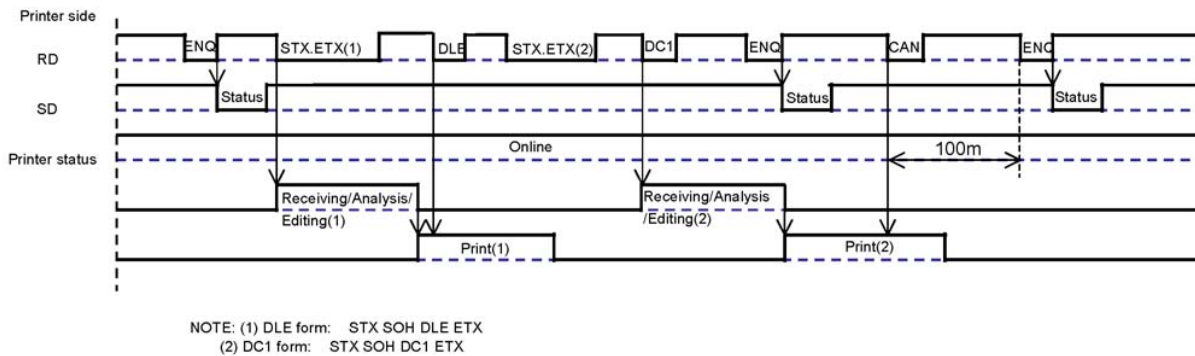

COMMAND PROCESS

(Figure 3-8e)

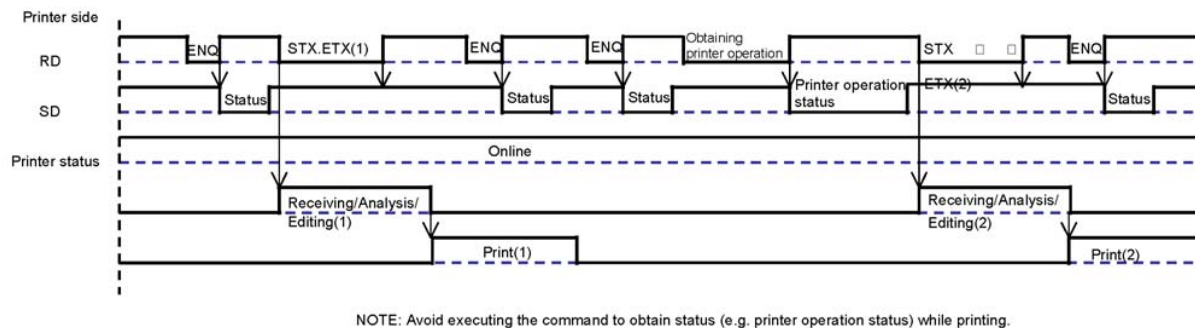

BCC ERROR PROCESS

(Figure 3-8f)

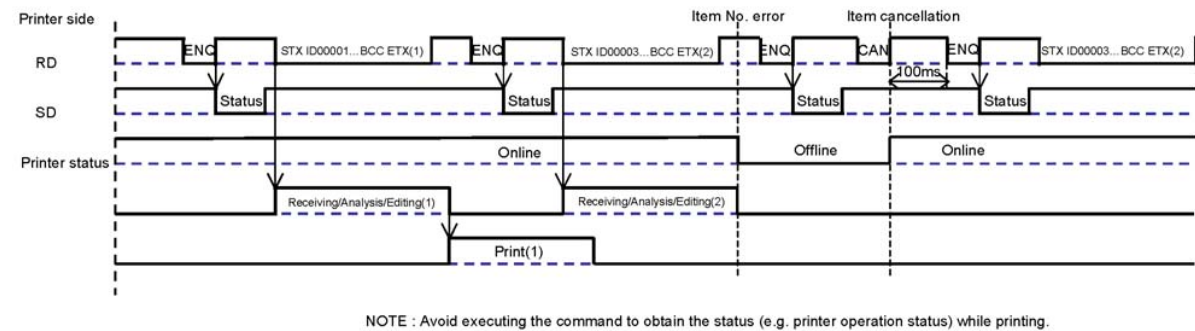

EXTERNAL SIGNAL

The external signal interface is designed to connect the printer to an applicator. Proceed to the printer's Advanced Mode for various setup activities related to the external signal.

There are two connector types available for the external signal interface, one with a 14-pin connector and the other with a 25-pin connector.

SPECIFICATIONS	
Signal Level	High: +2.4 to +5.0V, Low: +0.0 to +0.4V
Issuing/Reissuing EXT signal	Enable/Disable in the Advanced Mode.
Switching EXT signal	Switching jumper connector to enable +24V output by 24V and 27V power supplies. When using 24V power supply: Short IN 24V side by jumper connector When using 27V power supply: Short IN 27V side by jumper connector.
Signal Types	<p>Type I Print end signal (PREND) is "low" before printing labels, "high" after completion of print, and "low" 20 milliseconds later.</p> <p>Type II Print end signal (PREND) is "high" before printing labels, "low" after completion of print, and "high" 20 milliseconds later.</p> <p>Type III Print end signal (PREND) is "low" before printing labels, "high" from start to end of print, and "low" upon completion of print.</p> <p>Type IV Print end signal (PREND) is "high" before printing labels, "low" from start to end of print, and "high" upon completion of print.</p>

14-PIN CONNECTOR ASSIGNMENTS				
PIN	SIGNAL NAME	DIRECTION	LEVEL	MAX CURRENT
1	Paper End	Output	Low	5V, 400mA
2	Ground	--	--	--
3	Ribbon End	Output	High	5V, 400mA
4	Machine Error	Output	Low	5V, 400mA
5	Print Start (PRIN)	Input	Low	High: high impedance, Low: -15mA or more, 0V
6	Print End (PREND)	Output	Low	5V, 400mA
7	Reprint (PRIN2)	Input	Low	High: high impedance, Low: -15mA or more, 0V
8	EXT5V_IN	Input		5V
9	Online	Output	Low	5V, 400mA
10	Ribbon Near End	Output	Low	5V, 400mA
11	--	--	--	--
12	+24V	--	--	--
13	+5V	--	--	--
14	FG	--	--	--

Choose from Type I to Type IV for PREND (the output signal for Pin 6).

25-PIN CONNECTOR ASSIGNMENTS				
PIN	SIGNAL NAME	DIRECTION	LEVEL	MAX CURRENT
1	Frame Ground	---	---	---
2	+5V	---	---	---
3	---	---	---	---
4	Machine Error	Output	Low	5V, 400mA
5	Print End (PREND)	Output	Low	5V, 400mA
6	Online	Output	Low	5V, 400mA
7	---	---	---	---
8	Reprint (PRIN2)	Input	Low	High: high impedance, Low: -15mA or more, 0V
9	---	---	---	---
10	---	---	---	---
11	EXT_GND	---	---	---
12	+5V	---	---	---
13	+24V	---	---	---
14	GND	---	---	---
15	EXT_GND	---	---	---
16	Ribbon End	Output	High	5V, 400mA
17	Paper End	Output	Low	5V, 400mA
18	Ribbon Near End	Output	High	5V, 400mA
19	---	---	---	---
20	Print Start (PRIN)	Input	Low	High: high impedance, Low: -15mA or more, 0V
21	---	---	---	---
22	---	---	---	---
23	---	---	---	---
24	EXT5V_IN	Input	---	5V
25	GND	---	---	---

Choose from Type I to Type IV for PREND (the output signal for Pin 5). PREND will not be output when the command is "0" in the cutter mode.

Connect EXT_GND (Pins 11, 15) to external equipment GND.

Supply EXT5V_IN (Pin 24) 5V from the external power supply.

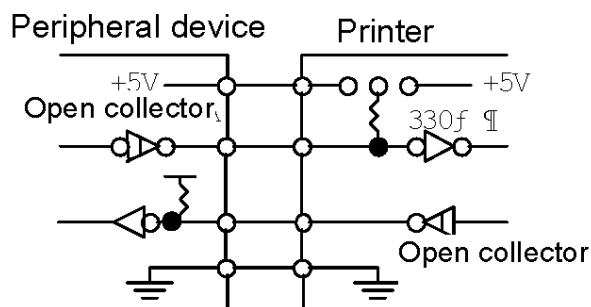

Figure 3-9, Input/Output Circuit Diagram

Unit 3: Installation

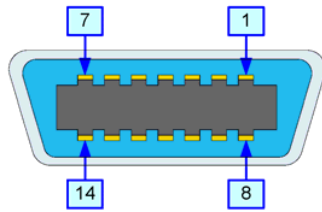

Figure 3-10, 14-Pin Connector Assignments

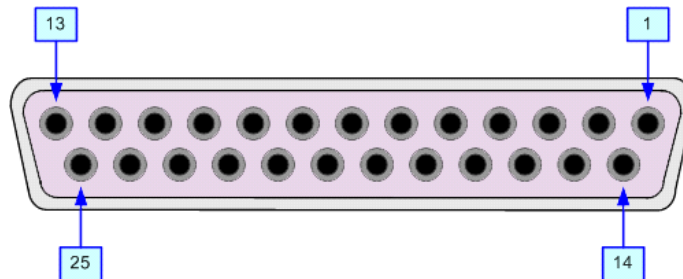
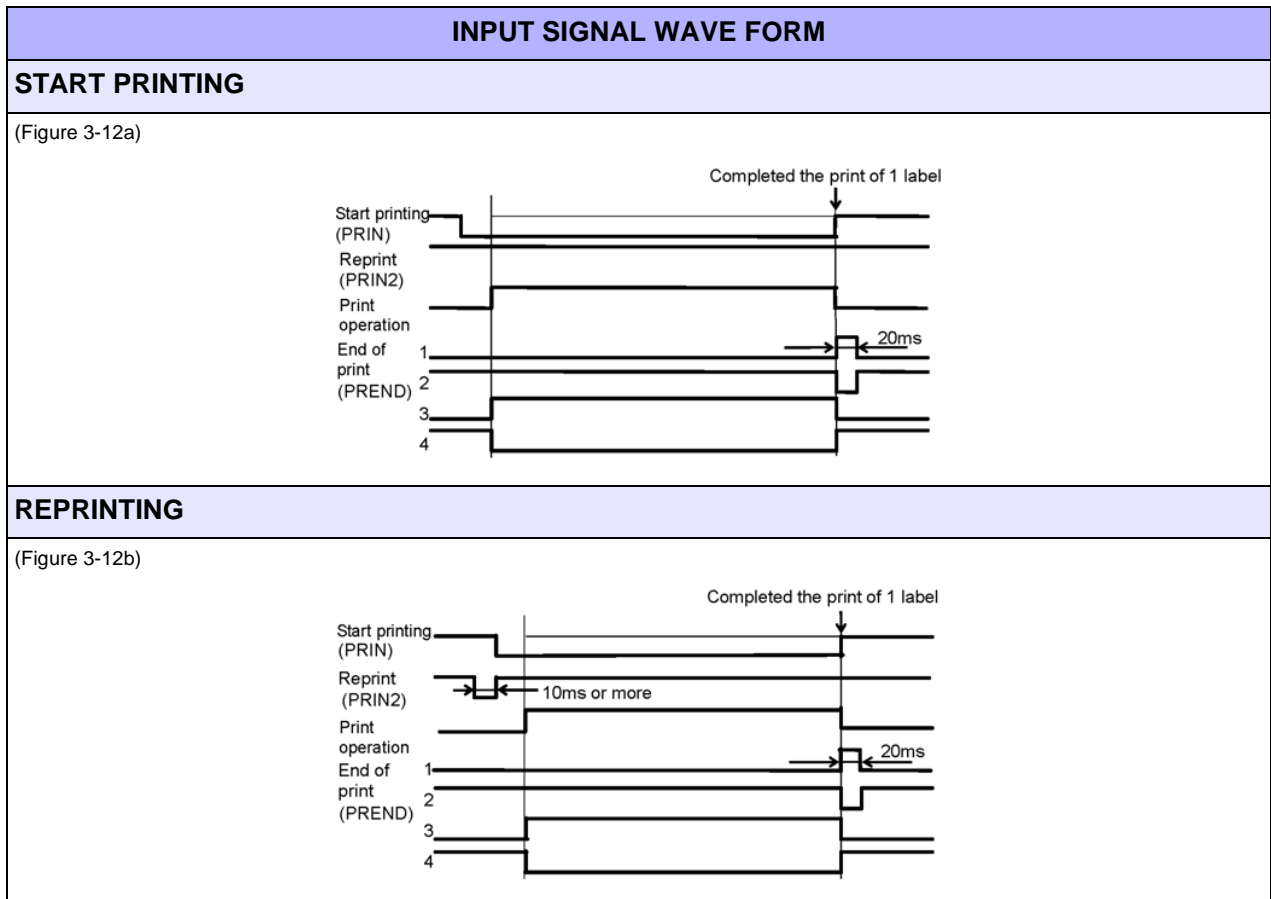

Figure 3-11, 25-Pin Connector Assignments



OUTPUT SIGNAL WAVE FORM

BASIC OPERATION

(Figure 3-13a)

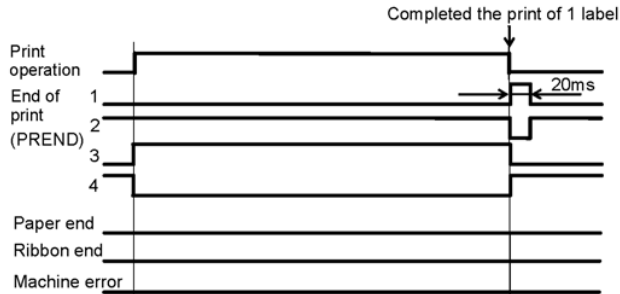

PAPER END

(Figure 3-13b)

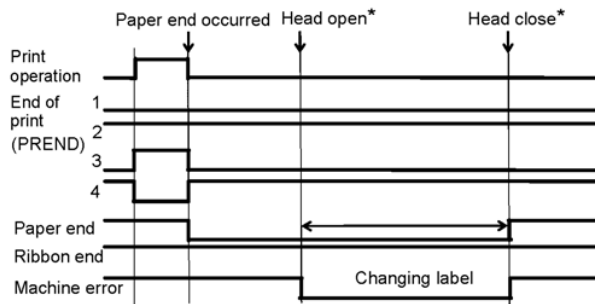

RIBBON END

(Figure 3-13c)

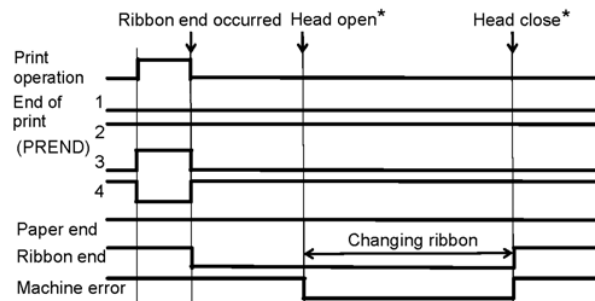

MACHINE ERROR

(Figure 3-13d)

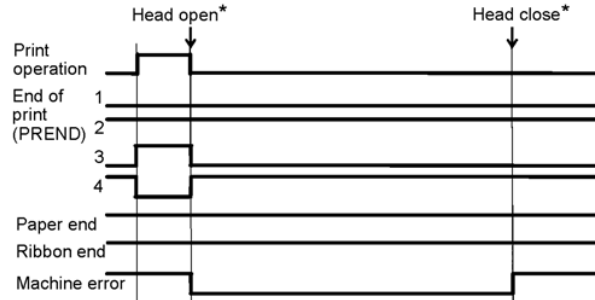

Unit 3: Installation

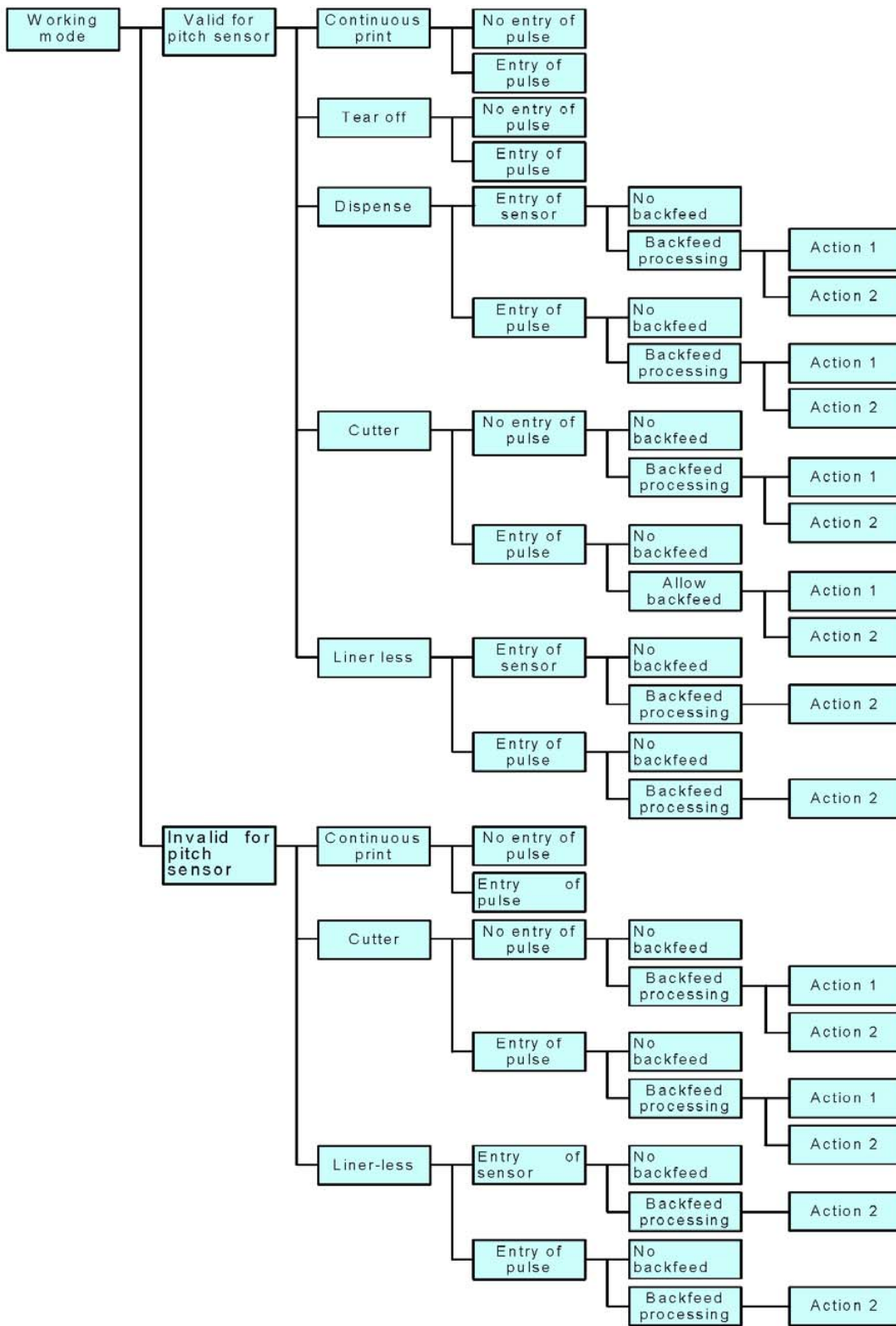

Action 1: Backfeed after printing
 Action 2: Print after backfeeding

Figure 3-14, Operation Mode Flow Chart

ACCESSORIES INSTALLATION

INTERFACE INSTALLATION

The diagram below (Figure 3-15) displays the physical installation of interface hardware. Refer to the Configuration unit of this manual for instructions on printer setup for the interface type chosen.

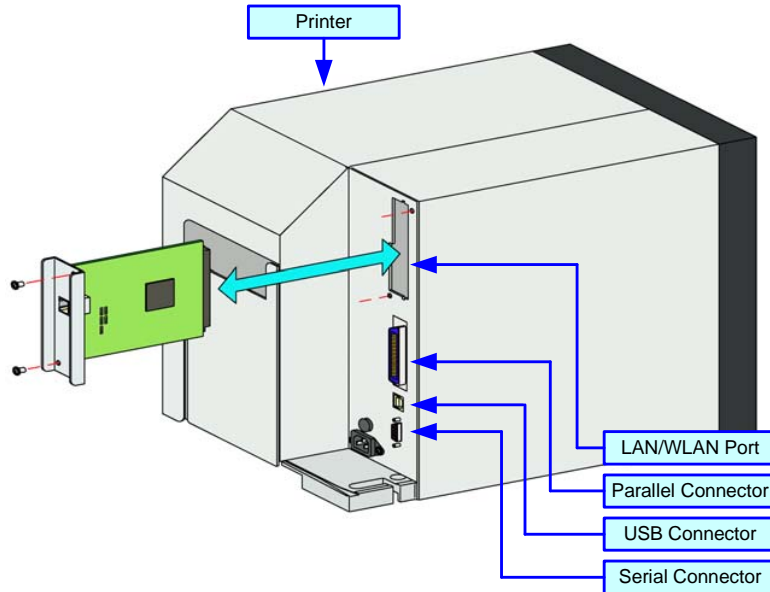

Figure 3-15, Interface Installation Diagram

FLASH MEMORY CARD

The memory cartridge provides additional storage of user data and graphics. The diagram below (Figure 3-16) displays the physical installation of the cartridge. Refer to the Configuration unit of this manual for instructions on printer setup for the interface type chosen.

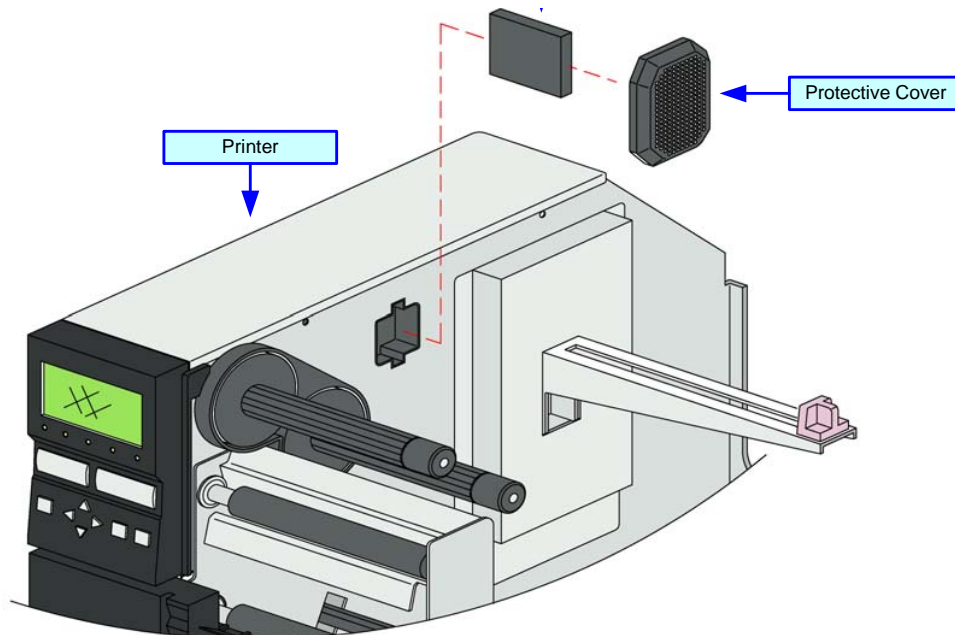

Figure 3-16, Memory Card Installation Diagram

4

PRINTER CONFIGURATION

- **Printer Configuration**
- **Configuration Modes**
- **Menu Definition Tables**

PRINTER CONFIGURATION

This unit provides in-depth instruction on printer configuration for operation and for some troubleshooting.

The printer may be configured via the buttons and/or potentiometers located on the printer's operator panel. All of the printer's buttons, switches, and potentiometers are used either singularly, or in conjunction, to perform configuration activities.

Refer to the Control Features chapter of the Introduction unit for identification of specific interface features.

CONFIGURATION MODES

This chapter provides an overview of the various configuration modes of the operation menu. All of the configuration activities are performed via the use of the operator panel located on the printer's face. However, many settings may also be controlled via external software commands.

USER MODE

This mode allows configuration of printing features that are prone to change from job to job. These are some of the most basic and common adjustments of all of the configuration modes.

Refer to the Menu Definition Tables in the following chapter to provide an explanation of each menu screen.

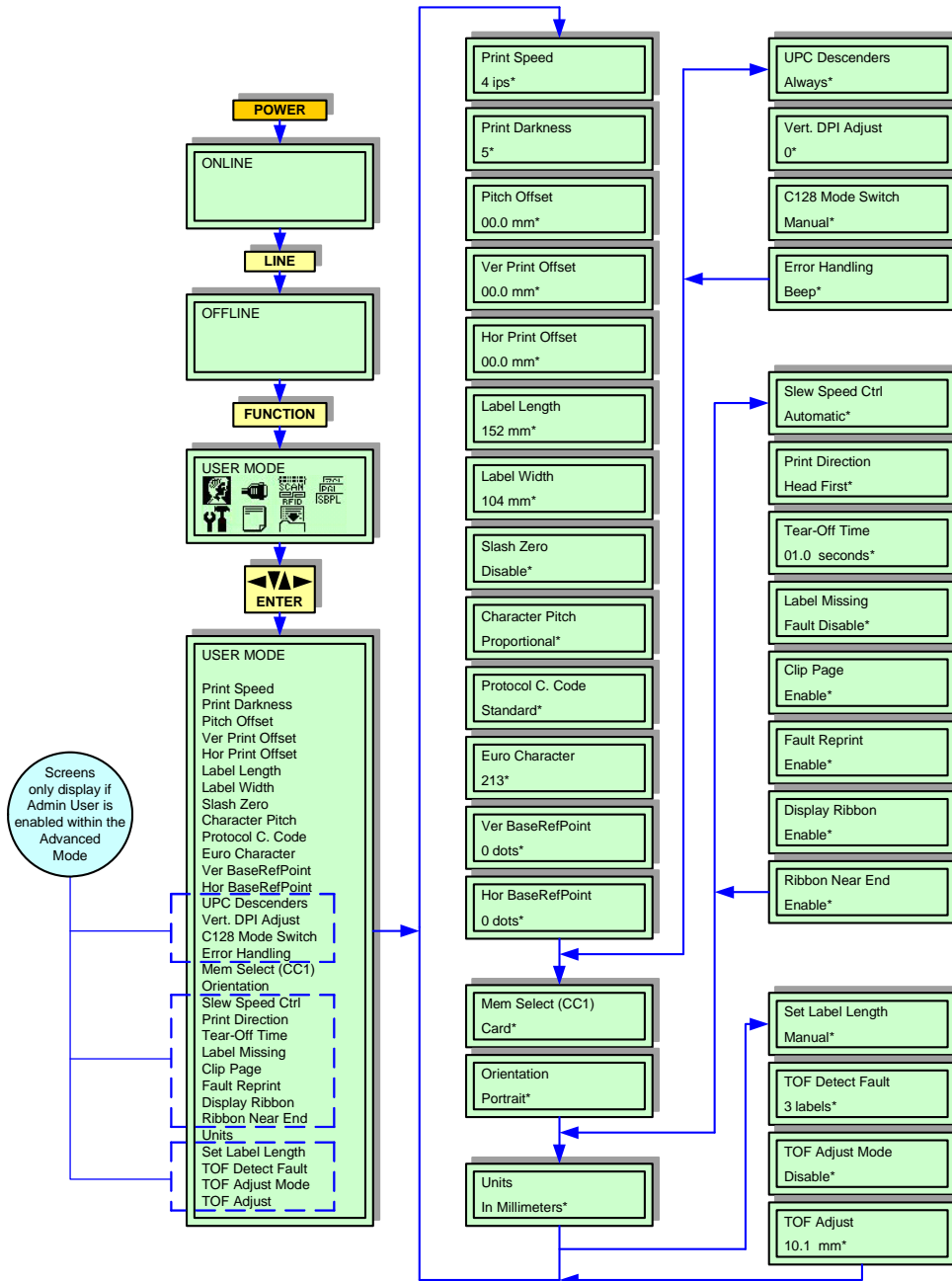

Figure 4-1, User Mode

CONFIGURATION MODE

The Configuration Mode is a set of menus that allows the operator to configure the printer on how to deal with multiple print jobs. This activity is focused on loading, saving, naming those jobs, and then deleting them when no longer needed.

Refer to the Menu Definition Tables in the following chapter to provide an explanation of each menu screen.

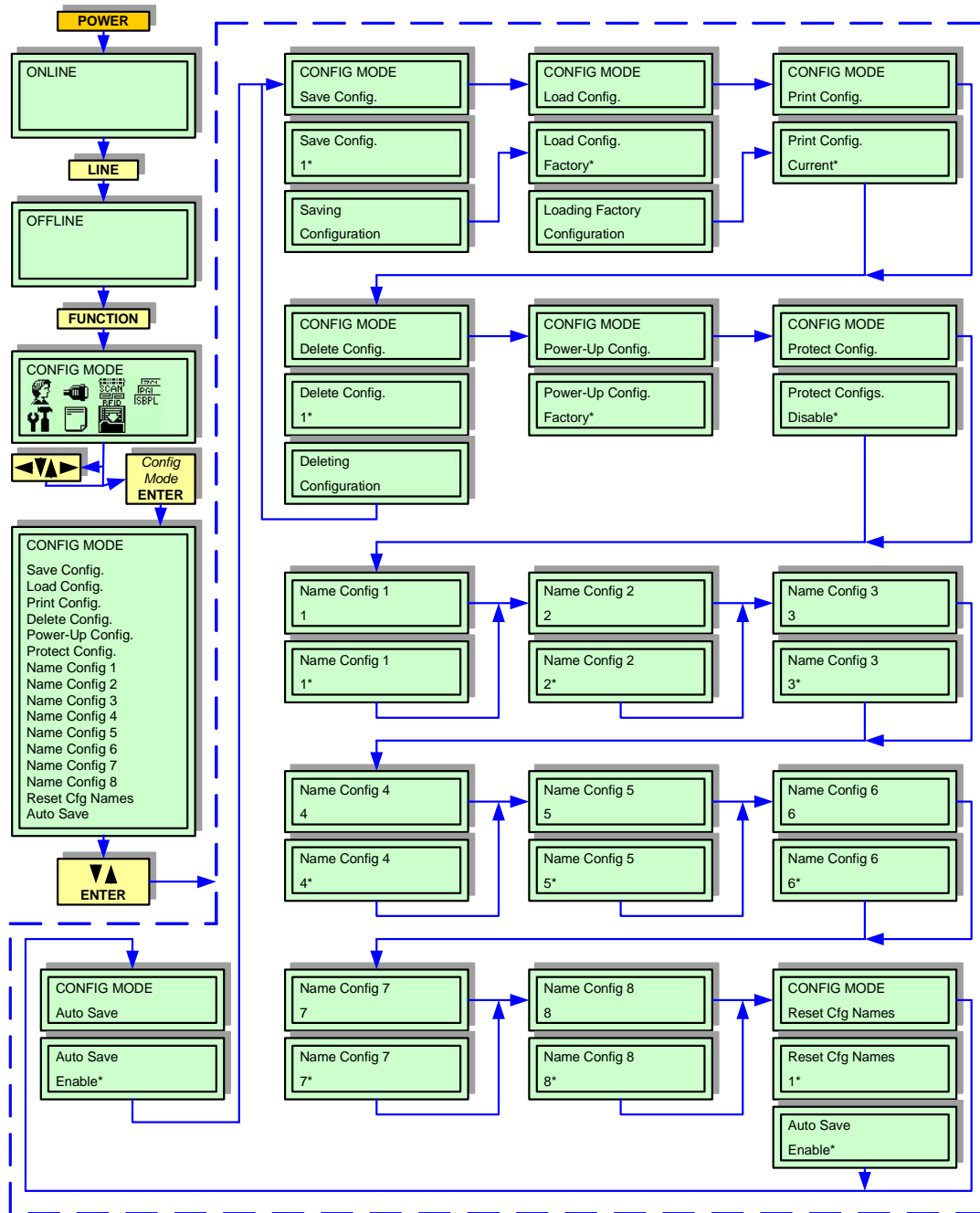

Figure 4-2, Configuration Mode

ADVANCED MODE

The Advanced Mode is provided to make basic printer operational adjustments. Typically, once these adjustments or settings have been made, they will not require additional address unless a new job is downloaded. Use the keys of the printer's operator panel to select and enter the required options.

Refer to the Menu Definition Tables in the following chapter to provide an explanation of each menu screen.

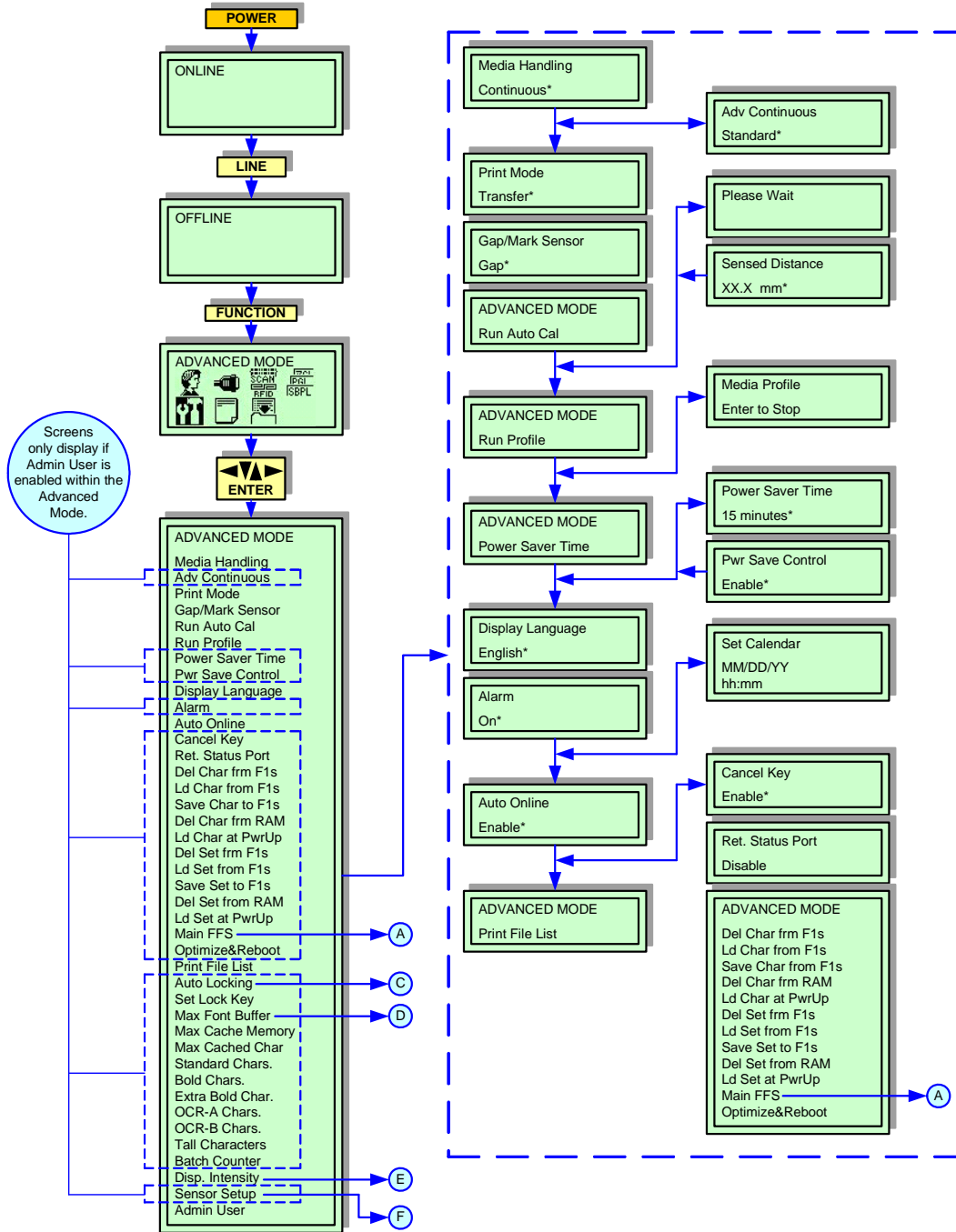

Figure 4-3a, Advanced Mode

Unit 4: Printer Configuration

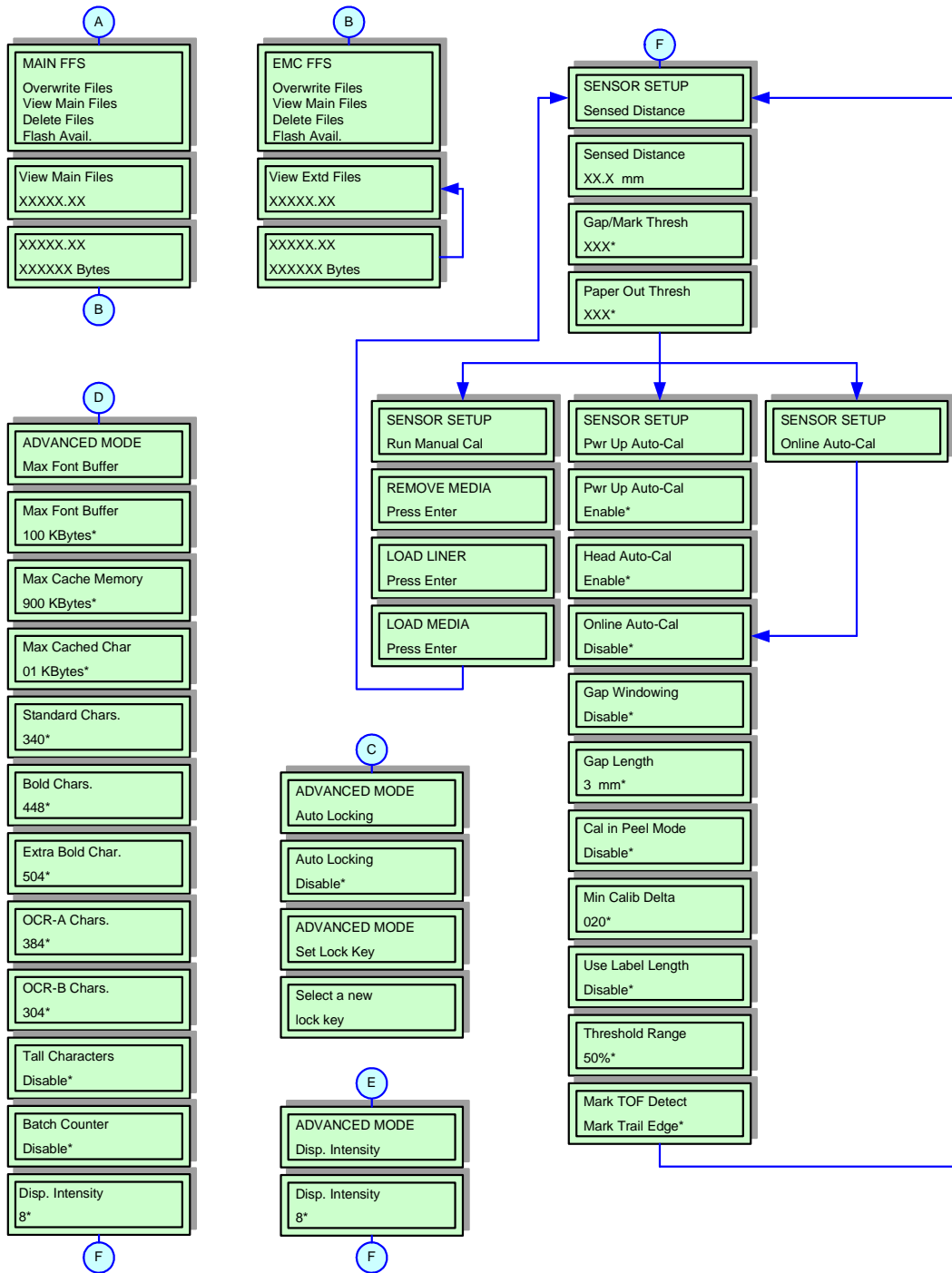

Figure 4-3b, Advanced Mode Continued

SERIAL INTERFACE MODE

This chapter provides the programming sequences required for RS232C and RS422 interface setup. Use the keys of the printer's operator panel to select and enter the required options.

Refer to the Menu Definition Tables in the following chapter to provide an explanation of each menu screen.

ATTENTION: Perform the following programming sequence only if this is the interface type to be used. Instead, refer to the appropriate interface programming chart.

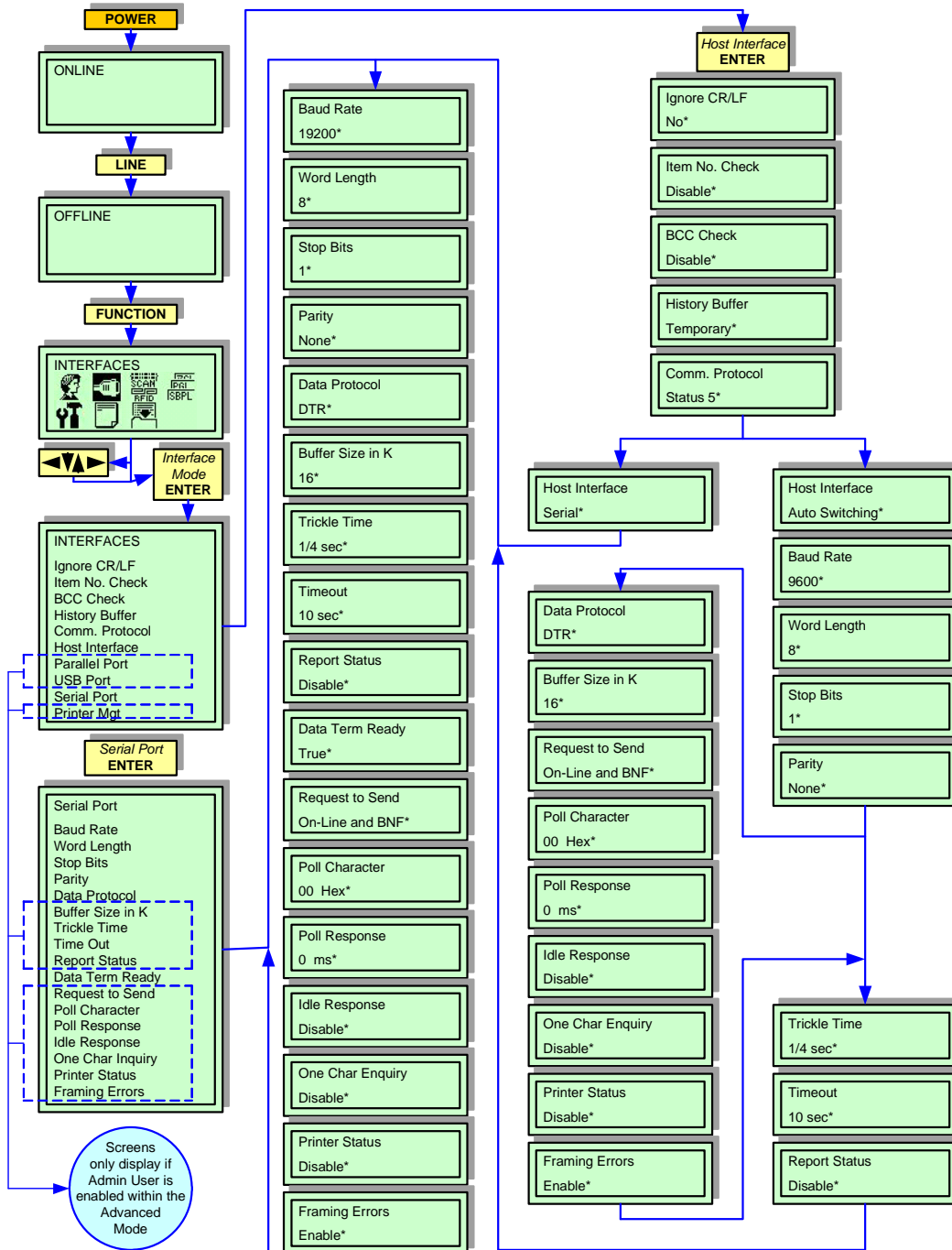

Figure 4-4, Serial Interface Mode

PARALLEL INTERFACE MODE

This chapter provides the programming sequences required for IEEE1284 interface setup. Use the keys of the printer's operator panel to select and enter the required options.

Refer to the Menu Definition Tables in the following chapter to provide an explanation of each menu screen.

ATTENTION: Perform the following programming sequence only if this is the interface type to be used. Instead, refer to the appropriate interface programming chart.

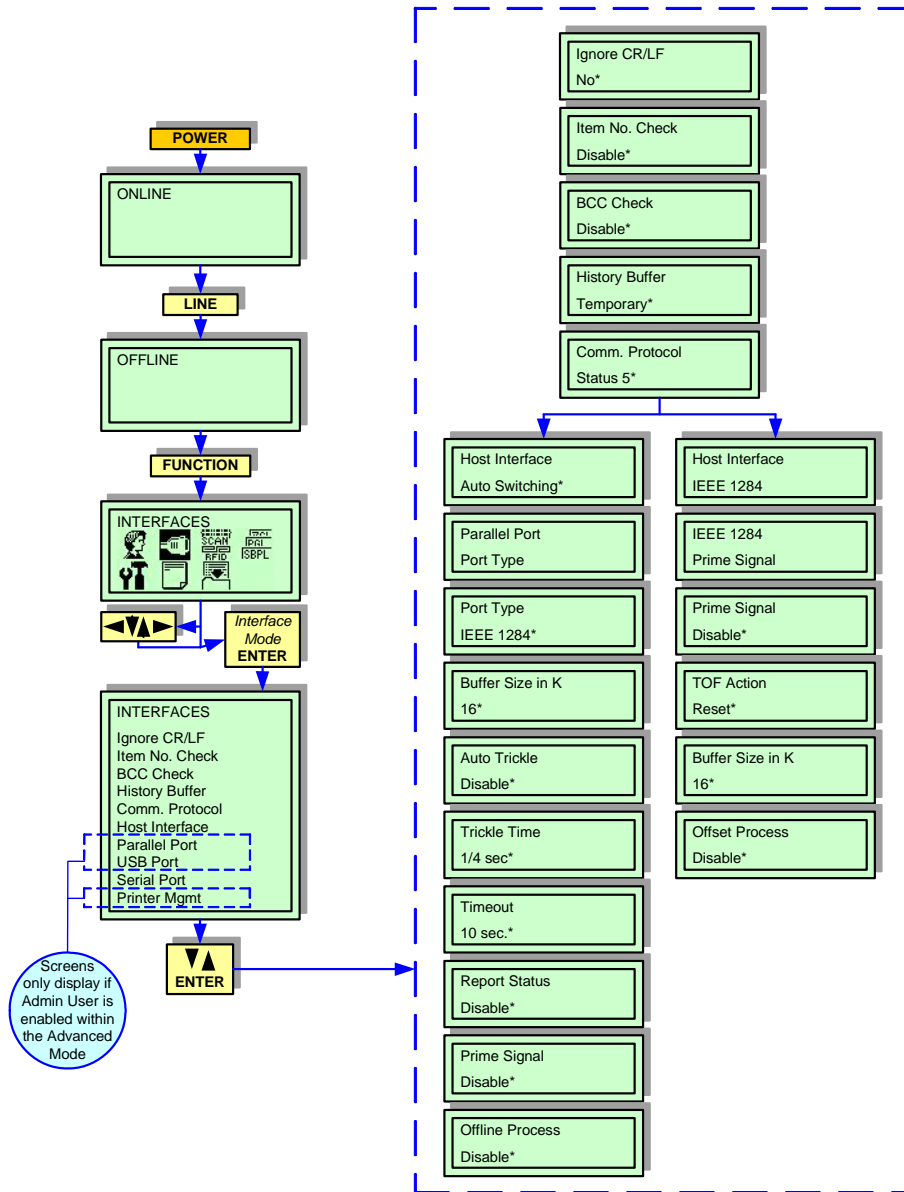

Figure 4-5, Parallel Interface Mode

CENTRONICS INTERFACE MODE

This chapter provides the programming sequences required for Centronics interface setup. Use the keys of the printer's operator panel to select and enter the required options.

Refer to the Menu Definition Tables in the following chapter to provide an explanation of each menu screen.

ATTENTION: Perform the following programming sequence only if this is the interface type to be used. Instead, refer to the appropriate interface programming chart.

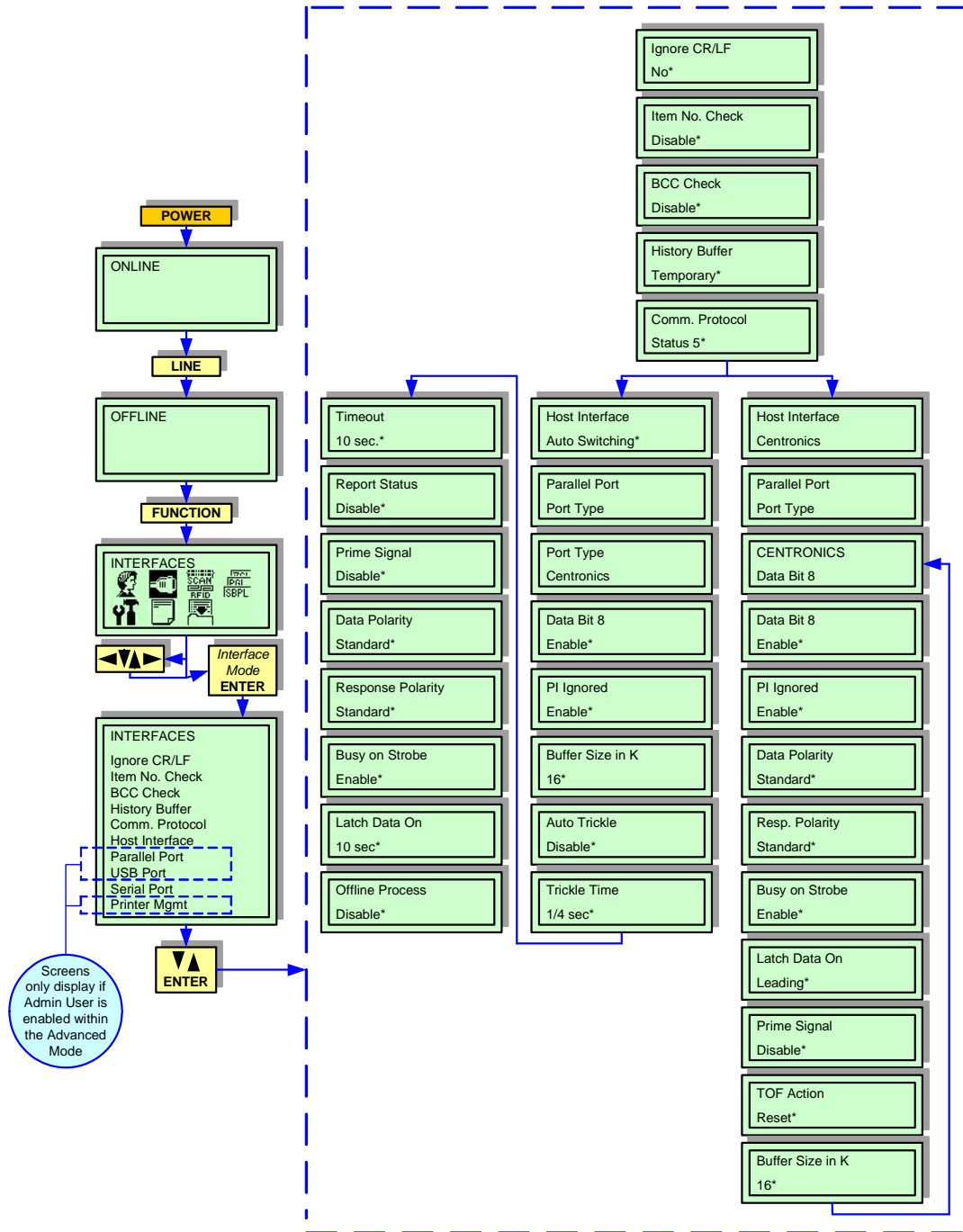

Figure 4-6, Centronics Interface Mode

UNIVERSAL SERIAL BUS (USB) INTERFACE MODE

This chapter provides the programming sequences required for USB interface setup. Use the keys of the printer's operator panel to select and enter the required options.

Refer to the Menu Definition Tables in the following chapter to provide an explanation of each menu screen.

ATTENTION: Perform the following programming sequence only if this is the interface type to be used. Instead, refer to the appropriate interface programming chart.

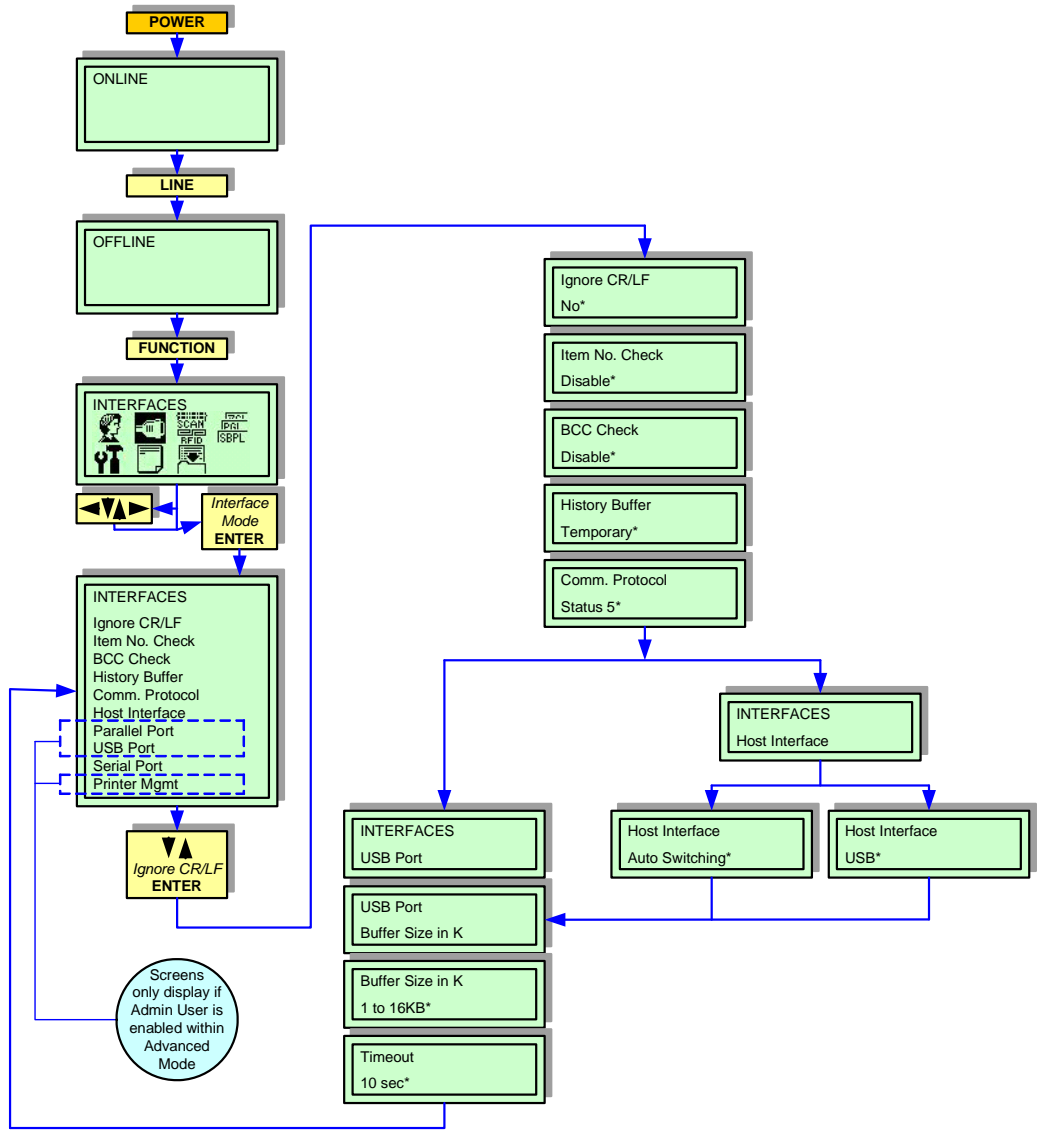

Figure 4-7, USB Interface Mode

LOCAL AREA NETWORK (LAN) INTERFACE MODE

This chapter provides the programming sequences required for LAN interface setup. Use the keys of the printer's operator panel to select and enter the required options.

Refer to the Menu Definition Tables in the following chapter to provide an explanation of each menu screen.

ATTENTION: Perform the following programming sequence only if this is the interface type to be used. Instead, refer to the appropriate interface programming chart.

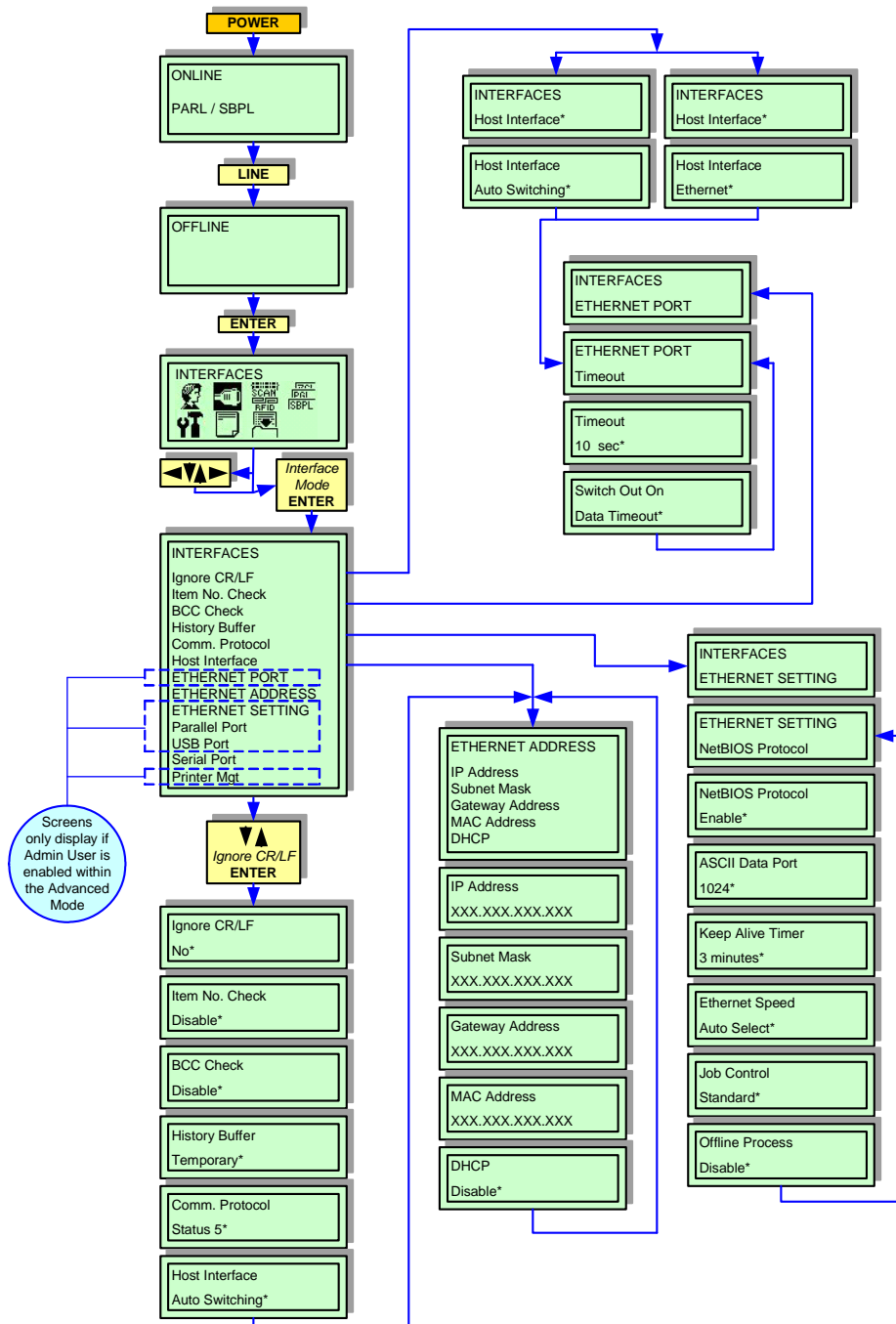

Figure 4-8, LAN Interface Mode

WIRELESS LOCAL AREA NETWORK (WLAN) INTERFACE MODE

This chapter provides the programming sequences required for WLAN interface setup. Use the keys of the printer's operator panel to select and enter the required options.

Refer to the Menu Definition Tables in the following chapter to provide an explanation of each menu screen.

ATTENTION: Perform the following programming sequence only if this is the interface type to be used. Instead, refer to the appropriate interface programming chart.

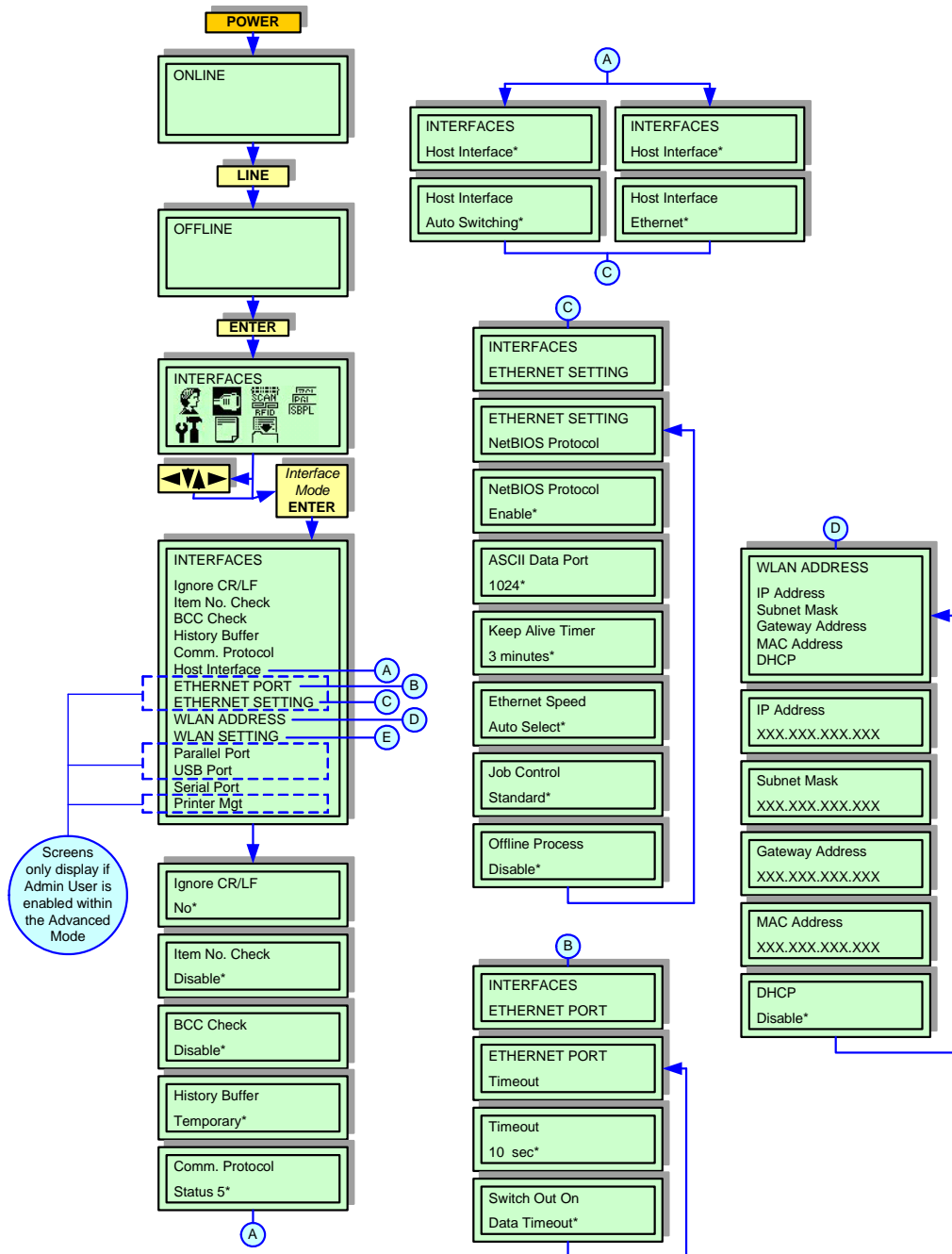

Figure 4-9, WLAN Interface Mode

PGL EMULATION MODE

This chapter provides the programming sequences required to correlate the printer's interpreter language with that of Printronics interpreter language. Use the keys of the printer's operator panel to select and enter the required options.

Refer to the Menu Definition Tables in the following chapter to provide an explanation of each menu screen.

ATTENTION: Perform the following programming sequence only if this is the emulation type required. Instead, refer to the appropriate emulation chart.

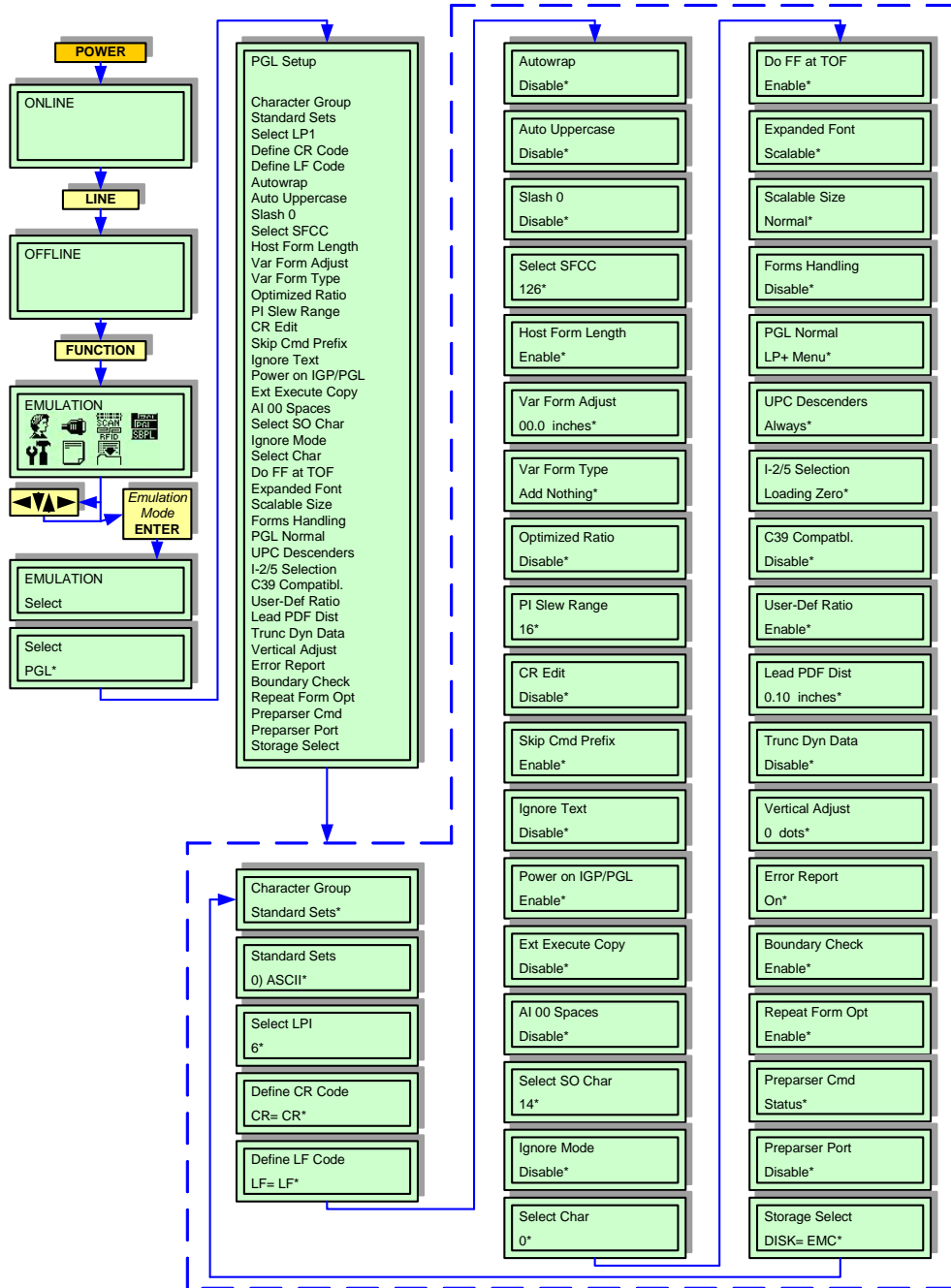

Figure 4-10, PGL Emulation Mode

ZGL EMULATION MODE

This chapter provides the programming sequences required to correlate the printer's interpreter language with that of Zebra interpreter language. Use the keys of the printer's operator panel to select and enter the required options.

Refer to the Menu Definition Tables in the following chapter to provide an explanation of each menu screen.

ATTENTION: Perform the following programming sequence only if this is the emulation type required. Instead, refer to the appropriate emulation chart.

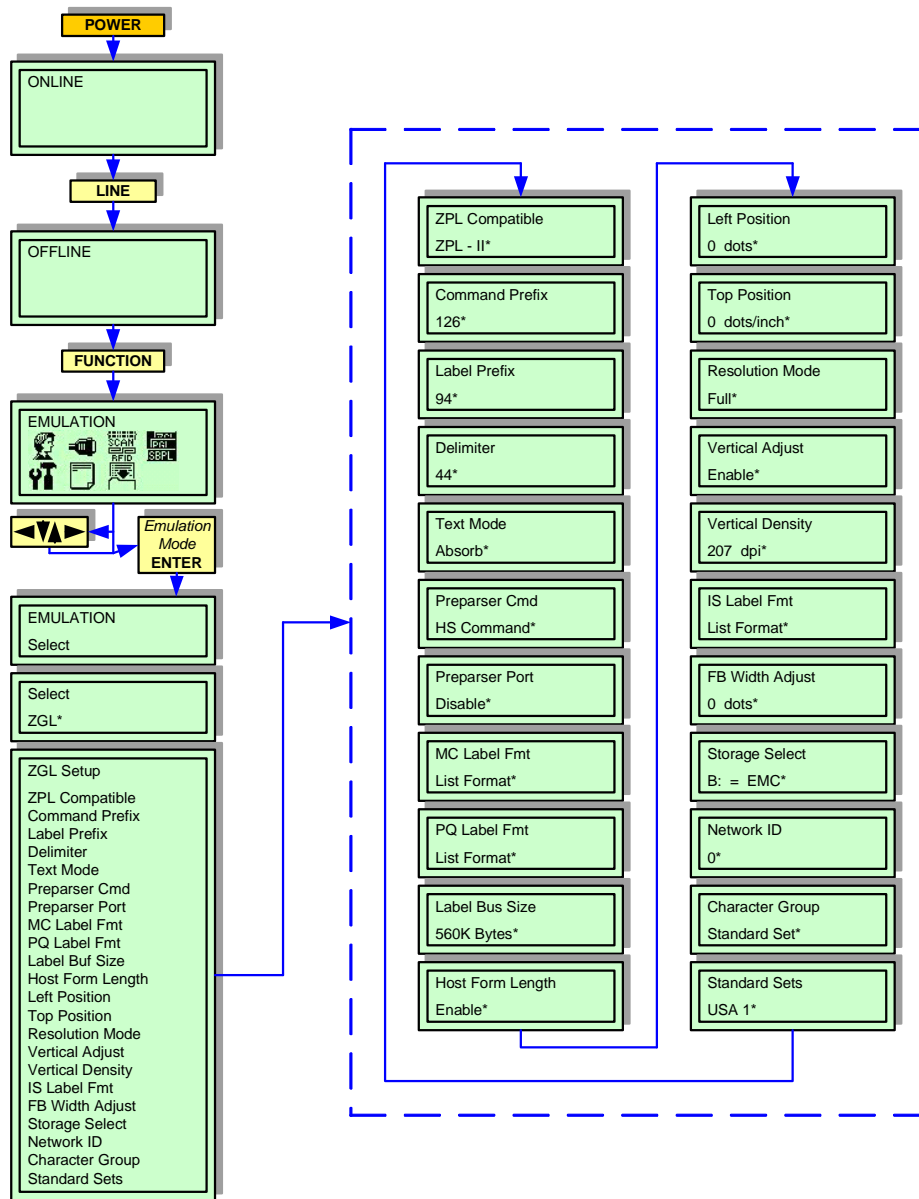

Figure 4-11, ZGL Emulation Mode

DGL EMULATION MODE

This chapter provides the programming sequences required to correlate the printer's interpreter language with that of Datamax interpreter language. Use the keys of the printer's operator panel to select and enter the required options.

Refer to the Menu Definition Tables in the following chapter to provide an explanation of each menu screen.

ATTENTION: Perform the following programming sequence only if this is the emulation type required. Instead, refer to the appropriate emulation chart.

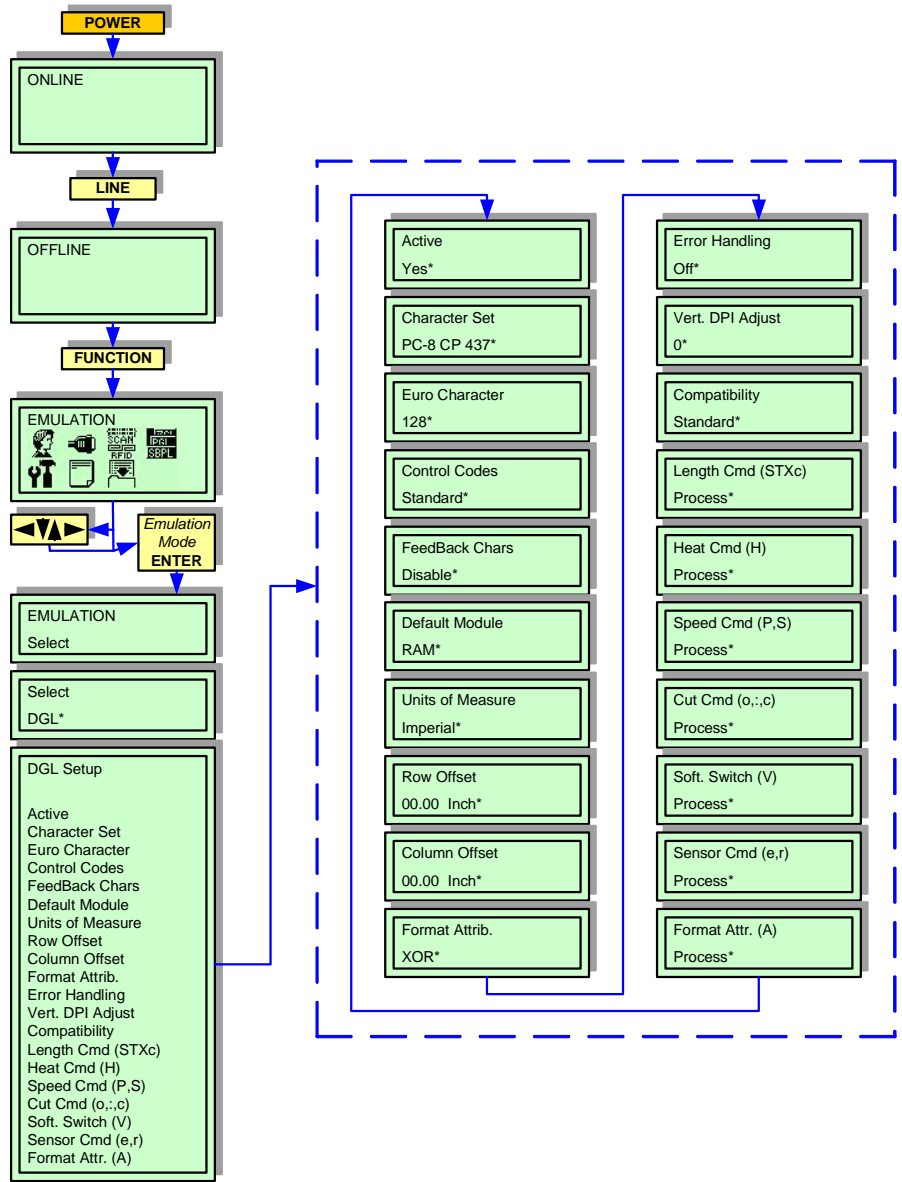

Figure 4-12, DGL Emulation Mode

TGL EMULATION MODE

This chapter provides the programming sequences required to correlate the printer's interpreter language with that of TEC interpreter language. Use the keys of the printer's operator panel to select and enter the required options.

Refer to the Menu Definition Tables in the following chapter to provide an explanation of each menu screen.

ATTENTION: Perform the following programming sequence only if this is the emulation type required. Instead, refer to the appropriate emulation chart.

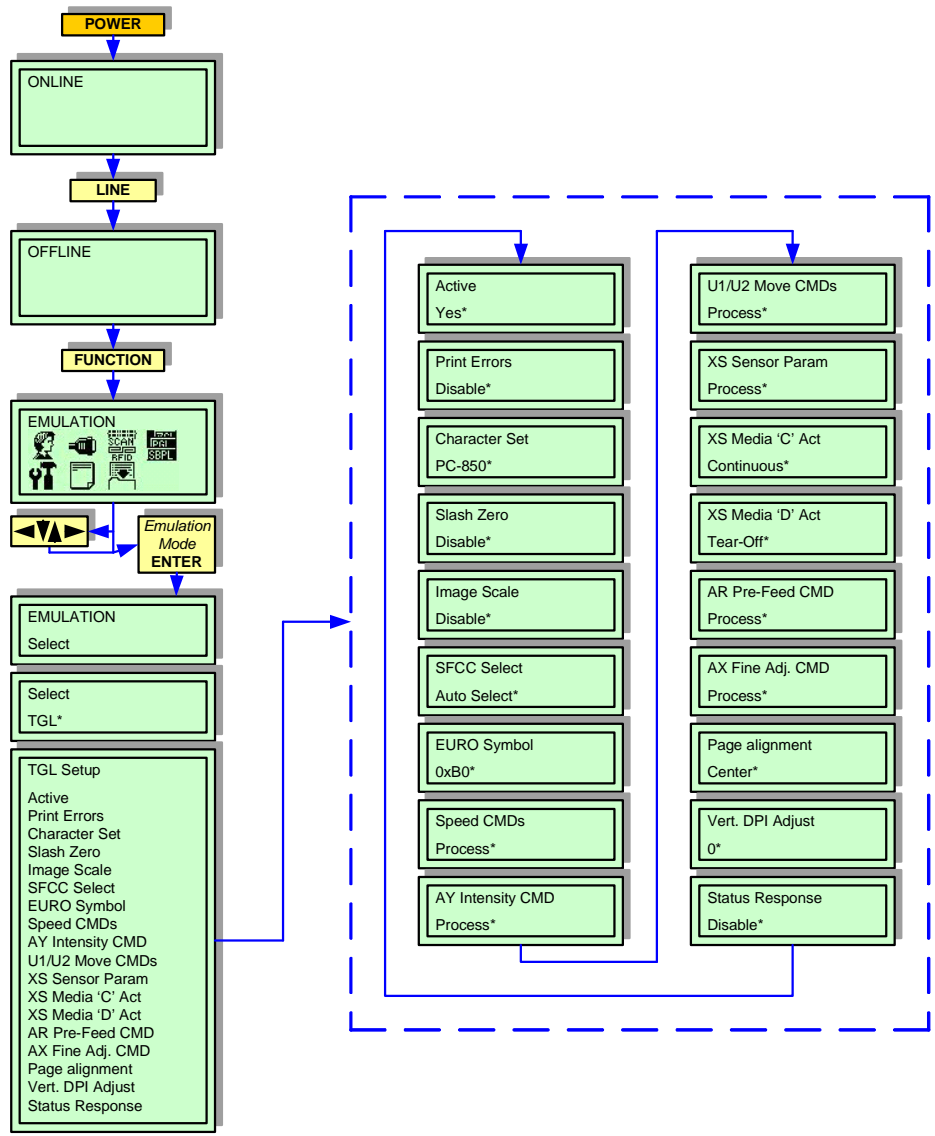

Figure 4-13, TGL Emulation Mode

IGL EMULATION MODE

This chapter provides the programming sequences required to correlate the printer's interpreter language with that of Intermecc interpreter language. Use the keys of the printer's operator panel to select and enter the required options.

Refer to the Menu Definition Tables in the following chapter to provide an explanation of each menu screen.

ATTENTION: Perform the following programming sequence only if this is the emulation type required. Instead, refer to the appropriate emulation chart.

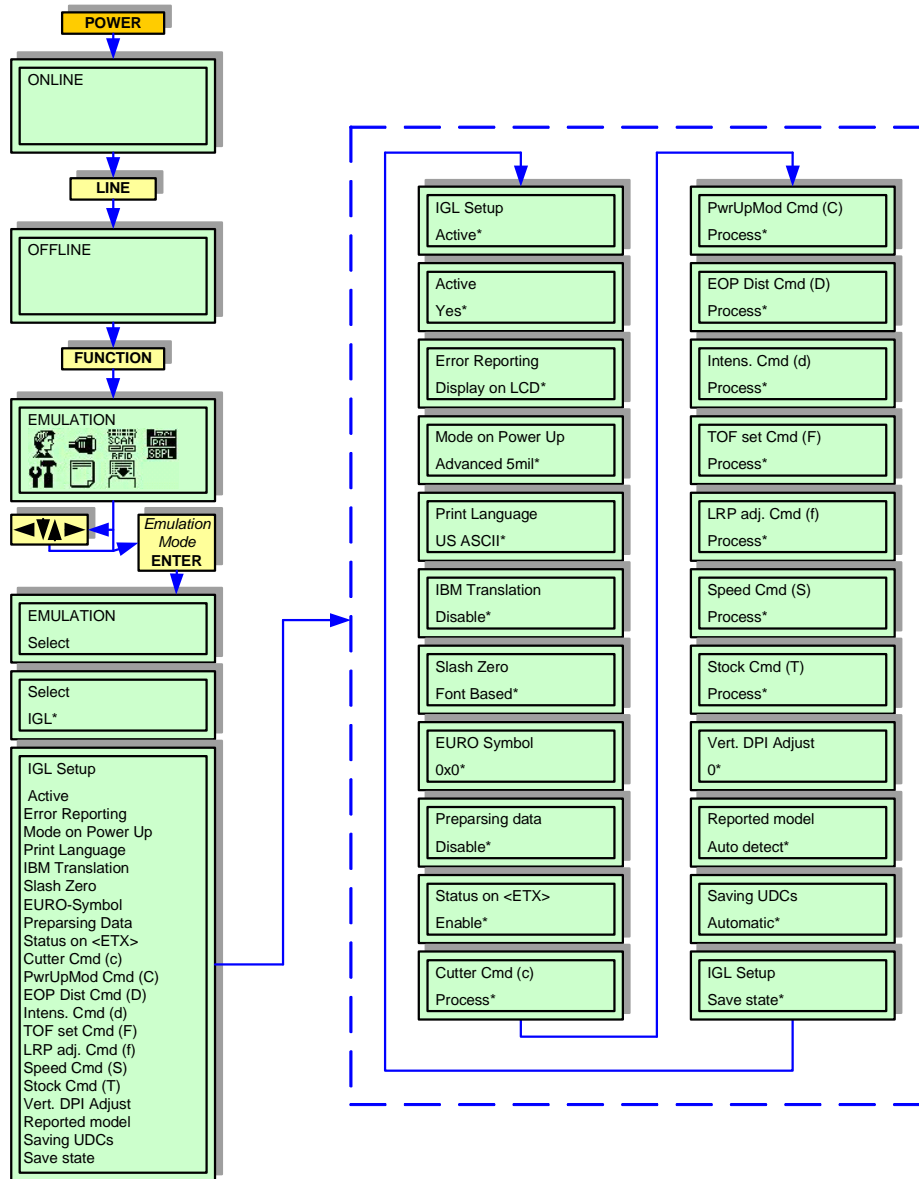

Figure 4-14, IGL Emulation Mode

DIAGNOSTICS MODE

This set of menu screens allows for the confirmation of various printer configurations, testing of its operational condition, and the monitoring of certain past activities. Use the keys of the printer's operator panel to select and enter the required options.

Refer to the Menu Definition Tables in the following chapter to provide an explanation of each menu screen.

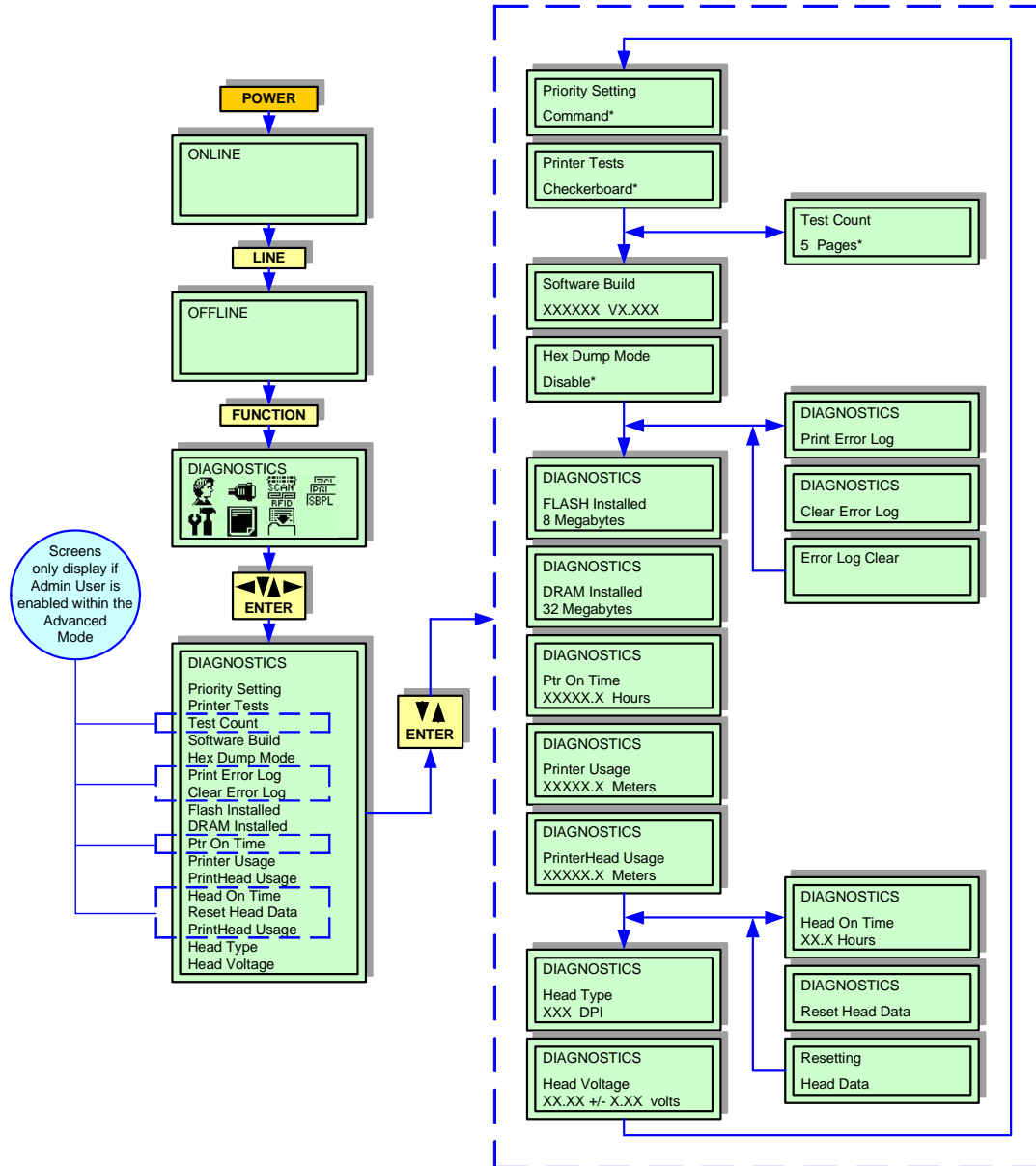

Figure 4-15, Diagnostics Mode

PRINTER MANAGEMENT MODE

This chapter provides the programming sequences required to connect and operate the printer through a systems network. The menu screens that will appear and will require address, is dependent on the interface type to be used.

Refer to the Menu Definition Tables in the following chapter to provide an explanation of each menu screen.

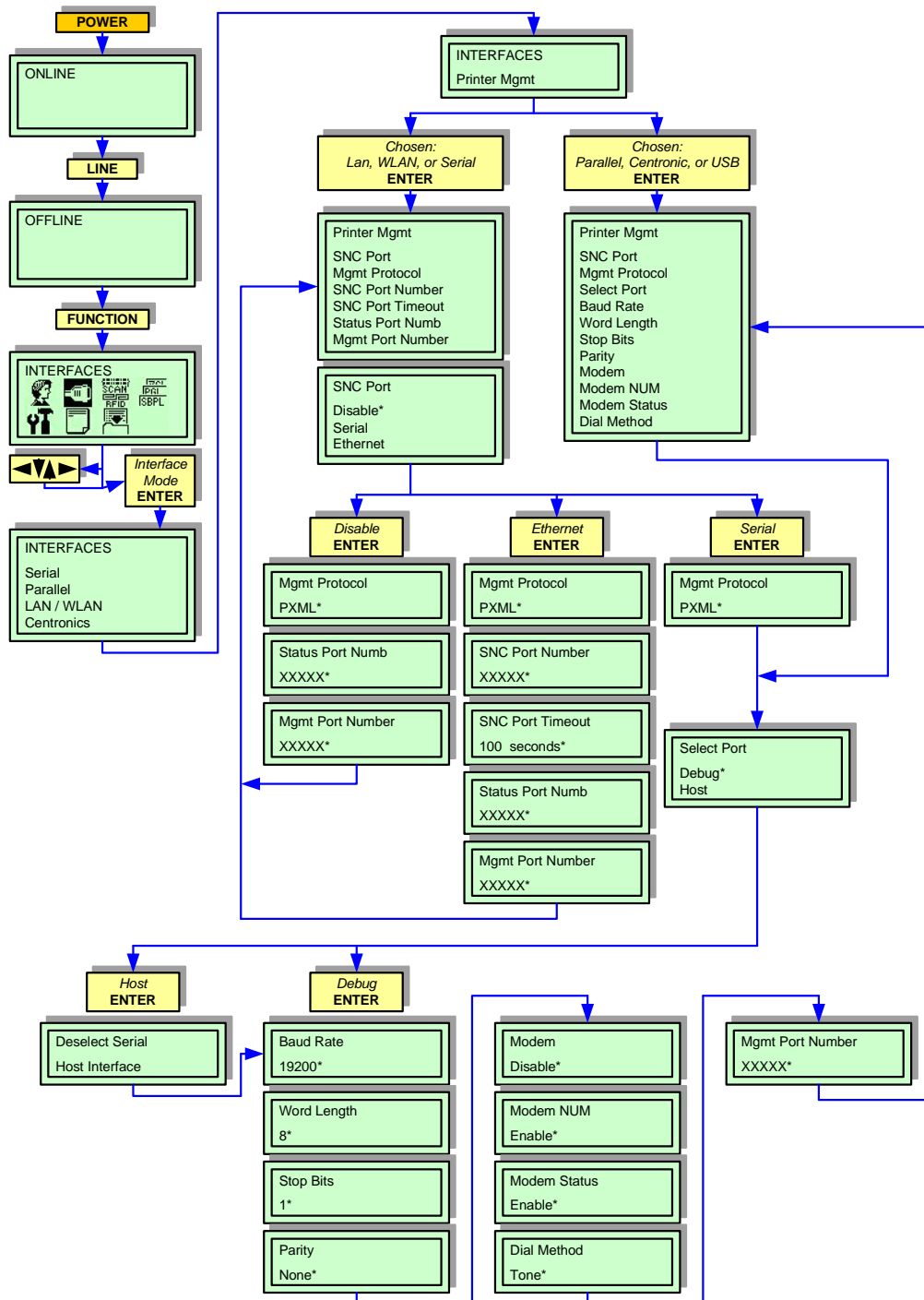

Figure 4-16, Printer Management Mode

MISC QUICK MENUS

The flow charts in this chapter provide quick access to certain printer features without having to enter their specific printer modes. All of the keystrokes required are performed via the printer's operator panel.

Refer to the Menu Definition Tables in the following chapter to provide an explanation of each menu screen.

DISPLAY INTENSITY ADJUSTMENT

The keystrokes identified in Figure 4-17 provide the steps required to adjust the brightness of the printer's LCD without having to enter the Advanced Mode.

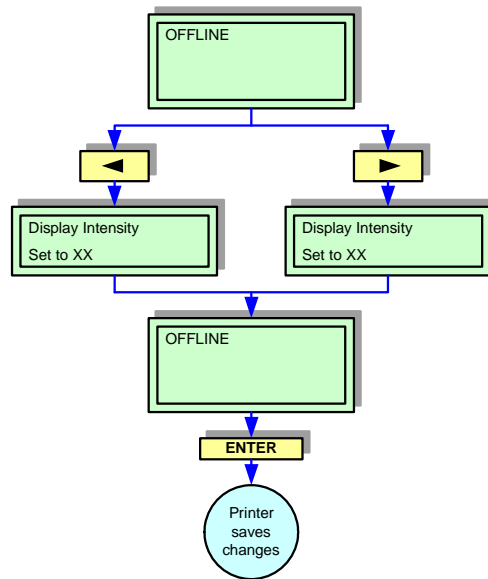

Figure 4-17, Display Intensity Adjustment

BUFFER CLEAR

The keystrokes identified in Figure 4-18 provide the steps required to perform a Hex Dump operation without having to enter the Diagnostics Mode.

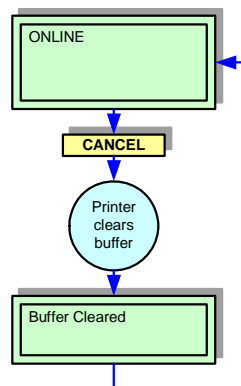

Figure 4-18, Buffer Clear

SOFT RESET

Reboots the printer back to an online state. If the reset is performed during a parameter change, it will not be saved. This reset will not erase any settings previously saved to non-volatile memory.

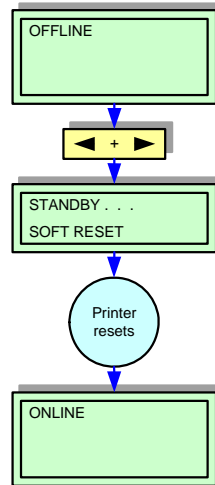

Figure 4-19, Soft Reset

KEY LOCK/UNLOCK

Certain keystrokes within the printer's menu tree is locked to prevent change under normal circumstances. These default menu settings may be changed however, by performing the keystrokes identified in Figure 4-20.

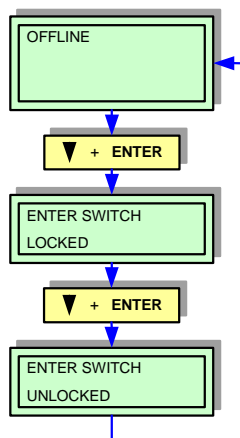

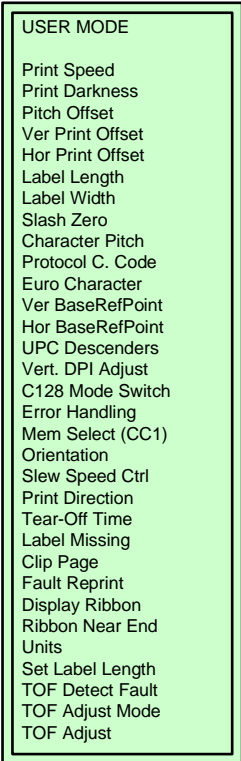
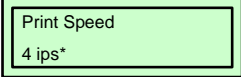
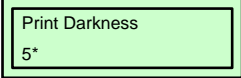
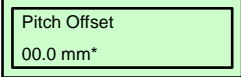

Figure 4-20, Key Lock/Unlock

MENU DEFINITION TABLES

USER MODE (TABLE 4-1)	
MENU	DESCRIPTION
	Permits entry into the USER Mode.
	Is the menu selection screen for the USER Mode.
	<p>Specifies the speed in inches per second (ips) at which the media passes through the printer while printing.</p> <p>The speed may be adjusted in increments of 1 ips with a range from 1 to 10 ips.</p> <p>The factory default is 4 ips.</p>
	<p>Specifies the level of thermal energy provided from the print head to affect print darkness. The print darkness setting needed is dependent on the type of ribbon and media installed for use and also relative to print speed.</p> <p>The adjustment range is from -15 to +15. The factory default is -3.</p>
	<p>This setting vertically adjusts where the printer begins printing relative to top-of-form.</p> <p>The allowable range is -12.7 to +5 millimeters.</p>



USER MODE (TABLE 4-1)	
MENU	DESCRIPTION
<div style="border: 1px solid black; padding: 2px; width: fit-content;"> Ver Print Offset 00.0 mm* </div>	<p>Specifies the distance to advance or retract the print image on the label to determine its vertical positioning. The actual image height is not affected by this adjustment, only its location.</p> <p>The factory default is -1.00 inches with a range of 6.00 inches. A negative value (-) retracts the image and a positive value (+) advances the image placement on the label.</p>
<div style="border: 1px solid black; padding: 2px; width: fit-content;"> Hor Print Offset 00.0 mm* </div>	<p>Specifies the lateral distance to move the print image on the label to determine its horizontal positioning. The actual image width is not affected by this adjustment, only its location.</p> <p>The factory default is 0.00 inches with a range from -1.00 inch to +1.00 inch. A negative value (-) moves the image closer to the printer's center frame and a positive value (+) moves the image from the printer's center frame.</p>
<div style="border: 1px solid black; padding: 2px; width: fit-content;"> Label Length 152 mm* </div>	<p>Typically specifies the physical label length of the media installed. However, the type of media in addition to its size it a determinant.</p> <ul style="list-style-type: none"> • Die-Cut Labels - the measurable length of the removable label. Does not include the liner material or gap. • Tag Stock w/ notices or holes - the measurable length is from the trailing edge of one notch or hole to the leading edge of the next notch or hole. • Tag Stock w/ black marks on underside - the measurable length from the leading edge of one black mark to the leading edge of the next black mark. • Continuous Media w/o indicators - the measurable length depends upon the image size. <p>The allowable label length is from 0.1 to 0.99 inches (2.5 - 2514.6mm). The factory default is 6 inches. The label length allowable is dependent on the label's width and the printhead resolution in use.</p>
<div style="border: 1px solid black; padding: 2px; width: fit-content;"> Label Width 104 mm* </div>	<p>Specifies the physical width of the print image. The allowable range is 0.1 to 4.1 inches (2.5 - 104mm).</p>
<div style="border: 1px solid black; padding: 2px; width: fit-content;"> Slash Zero Disable* </div>	<p>Determines if a zero is printed with or without a diagonal slash through it.</p>
<div style="border: 1px solid black; padding: 2px; width: fit-content;"> Character Pitch Proportional* </div>	<p>This setting determines whether each printer character occupies a designated space (Fixed) regardless of the character's width, or if the character's space is representative of its width (Proportional).</p> <p>Proportional is contemporarily preferred.</p>
<div style="border: 1px solid black; padding: 2px; width: fit-content;"> Protocol C. Code Standard* </div>	<p>The ESC sequence in SBPL commands may be defined as standard (using non-printable code 1BH) or non-standard (Hex 5E).</p>
<div style="border: 1px solid black; padding: 2px; width: fit-content;"> Euro Character 213* </div>	<p>Changes the address of the Euro character.</p>

USER MODE (TABLE 4-1)	
MENU	DESCRIPTION
<div style="border: 1px solid black; padding: 5px; width: fit-content;"> Ver BaseRefPoint 0 dots* </div>	This setting changes the vertical base reference point for the current label job and all subsequent label jobs. Its effect is identical to the <ESC>A3 Base Reference Point command.
<div style="border: 1px solid black; padding: 5px; width: fit-content;"> Hor BaseRefPoint 0 dots* </div>	This setting changes the horizontal base reference point for the current label job and all subsequent label jobs. Its effect is identical to the <ESC>A3 Base Reference Point command.
<div style="border: 1px solid black; padding: 5px; width: fit-content;"> UPC Descenders Always* </div>	This parameter allows the printing of bar code descenders when human readable data is not presented in the UPC/EAN barcodes. <ul style="list-style-type: none"> • No Change - factory default. • Always - factory default. UPC/EAN bar codes are printed with descenders even if human readable data is not present. • Never - UPC/EAN bar codes are printed without descenders.
<div style="border: 1px solid black; padding: 5px; width: fit-content;"> Vert. DPI Adjust 0* </div>	Allows fine adjustment of resolution used to scale page elements/coordinates. In cases where the printed label length is incorrect, the vertical resolution value used for calculations can be fine adjusted by this menu between -100 and +100 . Negative values result in a lower DPI value and thusly a longer label. Positive values result in a higher DPI value resulting in a shorter label. This adjustment does not affect the size of images and downloaded bitmap fonts.
<div style="border: 1px solid black; padding: 5px; width: fit-content;"> C128 Mode Switch Manual* </div>	Allows compatibility with older SATO printer models. By selecting 'Automatic' enables the printer to encode C128 bar code data using automatic mode switching. This action generally results in smaller barcodes.
<div style="border: 1px solid black; padding: 5px; width: fit-content;"> Error Handling Beep* </div>	If enabled, the printer will beep if an invalid code is deleted in the format file being downloaded/printed.
<div style="border: 1px solid black; padding: 5px; width: fit-content;"> Mem Select (CC1) Card* </div>	Specifies the memory assigned to parameters 1 and 2 of <ESC>CC command. If the operator panel selection is set to Card , the command <ESC>CC1 declares that the memory cartridge is to be used to recall/store data (graphic & font) and CC2 is to be used to access internal flash memory. If the operator panel selection is to Memory , the above scenrio is reversed.
<div style="border: 1px solid black; padding: 5px; width: fit-content;"> Orientation Portrait* </div>	This menu screen allows the image orientation on the printed label to be determined. <ul style="list-style-type: none"> • Portrait - specifies vertical page orientation with page height being greater than its width. The top-right corner of the image is positioned in the media's leading right corner. • Landscape - specifies horizontal orientation with page width being greater than its height. The top-left corner of the image is positioned in the media's leading left corner. • Inv. Portrait - specifies vertical page orientation with page height being greater than its width. The bottom-right corner of the image is positioned in the media's trailing left corner. • Inv. Landscape - specifies horizontal orientation with page width being greater than its height. The top-right corner of the image is positioned in the media's trailing right corner.

Unit 4: Printer Configuration

USER MODE (TABLE 4-1)	
MENU	DESCRIPTION
<div style="border: 1px solid black; padding: 2px;">Slew Speed Ctrl Automatic*</div>	<p>Allows selection of the manner of determining the speed of media movement during non-print activity.</p> <ul style="list-style-type: none"> • Automatic - always the same as the print speed. • Manual - allows the slew speed to be set. Selecting this option brings up another menu that allows a speed range from 2 to 10 ips. The factory default is 6 ips, but the maximum slew speed is also determined by the printer model.
<div style="border: 1px solid black; padding: 2px;">Print Direction Head First*</div>	<p>Determines basic print image orientation.</p> <ul style="list-style-type: none"> • Head First - the edge of the image that has been determined to be the top will be printed first. In the case of a portrait, the head will print and exit the printer first. • Foot First - the edge of the image that has been determined to be the bottom will be printed first. In the case of a portrait, the head will be printed and exit the printer last. <p>Note: This feature will not change the orientation of any test patterns in the DIAGNOSTIC mode.</p>
<div style="border: 1px solid black; padding: 2px;">Tear-Off Time 01.0 seconds*</div>	<p>Allows specification of the number of seconds after the buffer is empty that the printer will wait before it advances media to the tear bar position. This is applicable when Media Handling is set to Tear-Off Strip or Continuous mode and Continuous mode is set Tear-strip Full.</p> <p>The allowed range is .1 to 60.0 seconds and the factory default is 1.0 seconds.</p>
<div style="border: 1px solid black; padding: 2px;">Label Missing Fault Disable*</div>	<p>Allows a label to be detected at the tear bar for the Peel-Off Media mode.</p> <ul style="list-style-type: none"> • Fault Disable - factory default. The printer does not generate a fault condition if a missing label is encountered. • Fault Enable - the printer generates a fault condition if a missing label is encountered.
<div style="border: 1px solid black; padding: 2px;">Clip Page Enable*</div>	<p>Determines how the printer handles images that are too large for one physical page length when using gap or black mark media.</p> <ul style="list-style-type: none"> • Enable - factory default. When the user selected page length is greater than the physical page length, the printer clips the excess data to fit the physical page and the excess data is lost. The media sensor consequently looks for the gap, notch, hole, or black mark and when detected, uses it as the top-of-form position for the next label. Any remaining data is clipped from the label being printed. • Disable - when the user selected page length is greater than the physical page length dictated by the gap, notch, hole, or black mark on media, the printer continues to print the remaining excess data onto the next physical page. The media sensor looks for the gap, notch, hole, or black mark only after the media has advanced the distance specified by the label length value in the Media Setup menu or by the Host Forms Length value sent by via the software. Any gaps, notches, holes, or black marks that exist prior to reaching the Label Length or Host Forms Length are ignored. <p>Note: When Disable is selected, media sensing reliability can be improved, but the correct label length value must be entered. If the value is too long, the printer will ignore the actual gap or mark it needs to detect. When gap sensing is used, the Label Length value is equal to the physical length of a die-cut or removable label. When eye-mark sensing is used, the Label Length value is the physical distance from the leading edge of one eye-mark to the leading edge of the next.</p>
<div style="border: 1px solid black; padding: 2px;">Fault Reprint Enable*</div>	<p>This menu option determines how the printer handles data that was printing when an error occurred.</p> <ul style="list-style-type: none"> • Disable - factory default. Will not reprint a label affected by an error condition. • Enable - Will reprint a label affected by an error condition.
<div style="border: 1px solid black; padding: 2px;">Display Ribbon Enable*</div>	<p>When enabled and the printer is online, 1 to 4 asterisks will display on the LCD indicating the approximate amount of ribbon remaining on the supply spindle.</p> <p>**** = full to 3/4 full, *** = 1/2 to 3/4 full, ** = 1/4 to 1/2 full, * = 1/8 to 1/4 full.</p> <p>Enable is the factory default.</p>

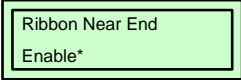
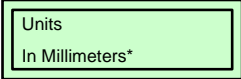
Unit 4: Printer Configuration

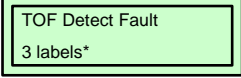
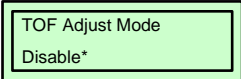
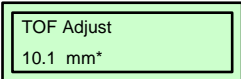
USER MODE (TABLE 4-1)	
MENU	DESCRIPTION
	<p>When enabled and the amount of ribbon remaining on the supply spindle is approximately 75 to 50 meters or less, the ON LINE indicator of the operator panel will flash and 'Ribbon Low' will display on the second line of the LCD. The warning message will not prevent printing.</p> <p>The Display Ribbon option must be enabled for the warning to display. Disable is the factory default setting.</p>
	<p>This menu screen allows selection of millimeters or inches as the unit of measure.</p> <p>Inches is the factory default.</p>
	<p>Allows selection of whether the Sensed Distance value derived from an Auto or Manual Calibrate will be used to set the Label Length value in the Media Setup menu.</p> <ul style="list-style-type: none"> • Manual - factory default. The Sensed Distance value derived from an Auto or Manual Calibrate will not override or change the Label Length value. • Automatic - when an Auto or Manual Calibrate is performed, the Sensed Distance value derived from either calibration will override and change the Label Length value. If Auto or Calibrate is not performed, the current Label Length value will be used. <p>Note: When Set Label Length = Automatic and the label sensor is set to Gap, the printer will subtract the Gap Length value (in the Sensor Setup menu of the Advanced Mode) from the Sensed Distance value obtained when the Auto or Manual Calibrate was performed. Setting the label length to 'Automatic' sets the 'Use Label Length' menu to 'Disable' in the Sensor Setup menu of the Advanced Mode.</p>
	<p>Allows selection of top-of-form detection fault. The printer displays a 'Gap Not Detected' fault and stops printing when media has advanced a distance equal to the selected quantity or more times the Label Length value set in menu.</p> <ul style="list-style-type: none"> • 3 Labels - factory default. • 9 Labels • 1 Label
	<p>Allows the top-of-form distance to be set using the TOF Adjust menu.</p> <ul style="list-style-type: none"> • Enable - enables the adjustment through the TOF Adjust menu. • Disable - factory default. Disables the adjustment through the TOF Adjust menu.
	<p>This option sets the distance from the top-of-form (TOF) that is left blank (unprinted) after a label has been removed in Tear-Off Strip. Printing normally starts at top-of-form, but when enabled, the print start position can be adjusted from 0.00 to 0.40 inches from top-of-form in increments of 0.01 inches.</p> <p>This adjustment is useful if a die-cut label sticks to the platen because of jagged edges created by poor label removal using the tear bar. By controlling how much blank space there is from top-of-form, the amount of media called back after being torn off can be controlled.</p>

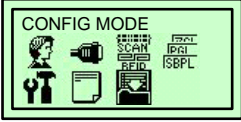
CONFIGURATION MODE (TABLE 4-2)	
MENU	DESCRIPTION
	<p>Permits entry into the CONFIGURATION Mode.</p>

CONFIGURATION MODE (TABLE 4-2)	
MENU	DESCRIPTION
<div style="border: 1px solid black; padding: 5px;"> <p>CONFIG MODE</p> <p>Save Config. Load Config. Print Config. Delete Config. Power-Up Config. Protect Config. Name Config 1 Name Config 2 Name Config 3 Name Config 4 Name Config 5 Name Config 6 Name Config 7 Name Config 8 Reset Cfg Names Auto Save</p> </div>	<p>Is the menu selection screen for the CONFIGURATION Mode.</p>
<div style="border: 1px solid black; padding: 5px;"> <p>CONFIG MODE</p> <p>Save Config.</p> </div>	<p>This menu allows up to eight unique configurations to be saved to meet different printer requirements. These saved configurations eliminate the need to change the parameter settings as needed. The configurations are stored in memory and will not be lost when the printer is powered off.</p> <p>Note: If the Protect Configs feature is enabled, the new configuration will not be saved unless the existing configuration has first been deleted.</p> <p>The factory default is 1.</p>
<div style="border: 1px solid black; padding: 5px;"> <p>Save Config.</p> <p>1*</p> </div>	<p>Is a sub-menu of the configuration save feature. This menu screen permits a particular print job to be assigned a numeral reference. As many as eight printer configurations may be saved.</p>
<div style="border: 1px solid black; padding: 5px;"> <p>Saving</p> <p>Configuration</p> </div>	<p>Is an informational menu screen displaying the configuration is being saved.</p>
<div style="border: 1px solid black; padding: 5px;"> <p>CONFIG MODE</p> <p>Load Config.</p> </div>	<p>The printer can store up to eight configurations in memory. This menu set allows the selection and loading of a specific configuration.</p>
<div style="border: 1px solid black; padding: 5px;"> <p>Load Config.</p> <p>Factory*</p> </div>	<p>Is a sub-menu of the configuration load feature. This menu screen permits a particular configuration to be assigned a numeral reference. As many as eight configurations may be loaded.</p> <p>The factory default is Factory.</p>
<div style="border: 1px solid black; padding: 5px;"> <p>Loading Factory</p> <p>Configuration</p> </div>	<p>Is an informational menu screen displaying the configuration is being loaded.</p>

Unit 4: Printer Configuration

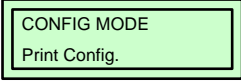
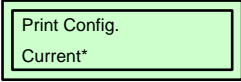
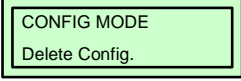
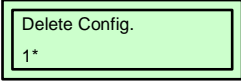
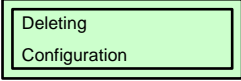
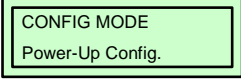
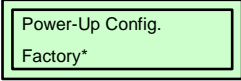
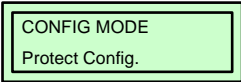
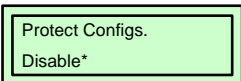
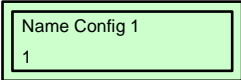
CONFIGURATION MODE (TABLE 4-2)	
MENU	DESCRIPTION
	<p>This menu set is used to print a list of various stored printer configurations. It is recommended that a printed list of loaded/saved configurations be kept for quick reference.</p>
	<p>Is a sub-menu of the configuration print feature. The factory default is Current.</p>
	<p>This menu set is used to delete specific configurations stored in the printer's memory.</p>
	<p>Allows the selection of the configuration to be deleted. The factory default may not be deleted. The factory default is 1.</p>
	<p>Is an informational menu screen displaying the configuration is being deleted.</p>
	<p>This menu set allows the selection of which stored configuration will be initialized when the printer is powered on. Any one of the saved configurations or the factory default configuration may be chosen. The factory default is Factory.</p>
	<p>Allows the selection of the configuration that will be initialized at startup.</p>
	<p>This menu set determines if a new configuration will overwrite an existing configuration.</p>
	<p>Allows the selection of the desired option.</p> <ul style="list-style-type: none"> • Disable - factory default. Will overwrite. • Enable - will not overwrite.
	<p>There is a menu set for each of the saved configurations (1 through 8). By entering the specific menu set designated for a particular configuration, that configuration may be provided with a text name. The assigned text name may not exceed 15 characters.</p> <p>When a configuration has been assigned a name here, all other menus (Save, Load, Print, Delete, Power-Up, Protect) relative to that particular configuration will also display the assigned file name.</p>

Unit 4: Printer Configuration

CONFIGURATION MODE (TABLE 4-2)	
MENU	DESCRIPTION
	This menu screen permits the designation of the desired file name. Use the arrow keys of the printer's operator panel to scroll and select appropriate characters in the appropriate sequence.
	This menu set permits file names for print configurations to be reset to their respective default configuration number. Either a particular file may reset or all.
	The available options for file name reset is 1, 2, 3, 4, 5, 6, 7, 8, or All . The factory default is 1 .
	This menu set allows selection of whether the printer will automatically prompt the operator to save alterations made to any of the stored configurations.
	<p>Allows selection of the desired menu option.</p> <ul style="list-style-type: none"> • Enable - factory default. Will prompt. • Disable - will not prompt. <p>Note: If currently in the Factory Config menus and a change is made, pressing ENTER saves to Config 1 or the next available configuration set and becomes the Power-Up Config.</p> <p>If the Current Config is configuration set 1 and a change is made, pressing ENTER will save the change to Config 1.</p>







ADVANCED MODE (TABLE 4-3)	
MENU	DESCRIPTION
	Permits entry into the ADVANCED Mode.

ADVANCED MODE (TABLE 4-3)	
MENU	DESCRIPTION
<div style="border: 1px solid black; padding: 5px;"> <p>ADVANCED MODE</p> <p>Media Handling</p> <p>Adv Continuous</p> <p>Print Mode</p> <p>Gap/Mark Sensor</p> <p>Run Auto Cal</p> <p>Run Profile</p> <p>Power Saver Time</p> <p>Pwr Save Control</p> <p>Display Language</p> <p>Alarm</p> <p>Auto Online</p> <p>Cancel Key</p> <p>Ret. Status Port</p> <p>Del Char frm F1s</p> <p>Ld Char from F1s</p> <p>Save Char to F1s</p> <p>Del Char frm RAM</p> <p>Ld Char at PwrUp</p> <p>Del Set frm F1s</p> <p>Ld Set from F1s</p> <p>Save Set to F1s</p> <p>Del Set from RAM</p> <p>Ld Set at PwrUp</p> <p>Main FFS</p> <p>Optimize&Reboot</p> <p>Print File List</p> <p>Auto Locking</p> <p>Set Lock Key</p> <p>Max Font Buffer</p> <p>Max Cache Memory</p> <p>Max Cached Char</p> <p>Standard Chars.</p> <p>Bold Chars.</p> <p>Extra Bold Char.</p> <p>OCR-A Chars.</p> <p>OCR-B Chars.</p> <p>Tall Characters</p> <p>Batch Counter</p> <p>Disp. Intensity</p> <p>Sensor Setup</p> <p>Admin User</p> </div>	<p>Is the premiere menu screen of the Advanced Mode. Allows scrolling and selection of its primary menu options.</p>
<div style="border: 1px solid black; padding: 5px;"> <p>Media Handling</p> <p>Continuous*</p> </div>	<p>Permits selection of the media handling method desired.</p> <ul style="list-style-type: none"> • Tear-Off - factory default. Prints labels until the print buffer is empty, then positions the last label over the tear bar for removal. • Continuous - prints continuously and feeds the printed labels along with its backing paper. • Peel-Off - prints die-cut labels and automatically peels away the backing paper as each label advances from the printer. The printer waits until the printed label is taken for application before printing the next label. This method is only supported when the Value Peel or the Peel-Off Rewinder option is installed. A Remove Label message will display on the LCD prompting label removal for each label printed. • Cut - cuts printed labels or tags at the user specified intervals. Cutting may occur after each printed label/tag or following a specified quantity. Only available with cutter assembly installed. • Rewind - rewinds printed labels onto a spindle assembly. This option is used for efficient storage of the printed labels to be applied at a later date. Only available with rewinder assembly installed.

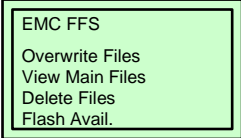
ADVANCED MODE (TABLE 4-3)	
MENU	DESCRIPTION
<div style="border: 1px solid black; padding: 2px; width: fit-content;"> Adv Continuous Standard* </div>	<p>Allows selection of special media modes when the Continuous option is chosen as the Media Handling method.</p> <ul style="list-style-type: none"> • Standard - factory default. Printing occurs without automatic media offset or positioning for each consecutive label. In such applications, the FEED key may need to be pressed to position the next label for printing. Will result in a blank label being fed between each printed label to advance the media sufficiently to remove the printed label. • Tear-Off - provides offset movement of the media to position the perforated line of its backing paper at the tear bar. This option will not result in blank labels as with the Standard method, but only supports label lengths 2.50 inches or longer. • Tear-Strip Full - provides offset movement of the media to position the perforated line of its backing paper at the tear bar once the print buffer is empty for a period Test Strip Time (media is not aligned at the tear bar until that time expires). when printable data is again detected, a blank label is automatically fed resulting in one blank label between each print job. This option supports label lengths 2.50 inches or longer. Shorter label lengths will result in two or more blank labels to be automatically fed at the beginning of each print job.
<div style="border: 1px solid black; padding: 2px; width: fit-content;"> Print Mode Transfer* </div>	<p>This option specifies the media type to be used.</p> <ul style="list-style-type: none"> • Transfer - factory default. Indicates thermal transfer media requiring ribbon stock. • Direct - indicates direct thermal printing using heat sensitive media without ribbon stock.
<div style="border: 1px solid black; padding: 2px; width: fit-content;"> Gap/Mark Sensor Gap* </div>	<p>Allows specification of the label sensor to be used relative to the media type for label length indication (gap, notch, hole, eye-mark).</p> <ul style="list-style-type: none"> • Gap - factory default. Select when using media with a liner space between die-cut labels or when using tag stock with notches or holes as length indicators on white background media. The top-of-form position is the leading edge of the die-cut label (trailing edge of the gap, notch, hole). • Disable - select when using media without label length indicators (without gap, notch, hole, eye-mark) or to ignore any present length indicators. When this option is chosen, label length will be based on the Label Legth value entered in the Media Setup menu or the value sent via host software. • Mark - select when using eye-mark media or tag stock. The top-of-form position is the leading edge of the eye-mark indicator (black mark).
<div style="border: 1px solid black; padding: 2px; width: fit-content;"> ADVANCED MODE Run Auto Cal </div>	<p>This feature is used to improve the sensitivity and reliability of the printer's label sensor in detecting reference indicators (gap, notch, hole, eye-mark) as well as, a paper-out condition.</p> <p>Press the ENTER key of the operator panel while 'Run Auto-Cal' is displayed on the LCD. the printer will then advance media the distance required to accurately detect the label length indicator, then stop at the top-of-form position. The LCD will momentarily display the Sensed Distance. The end result will be a change to the Gap/Mark Threshold, Paper-Out Threshold, and Sensed Distance values that the printer will use. The changes will take effect immediately within the current configuration menu.</p>
<div style="border: 1px solid black; padding: 2px; width: fit-content;"> Please Wait </div>	<p>Is an informational menu screen. Indicates that automatic calibration is in process from Run Auto-Cal.</p>
<div style="border: 1px solid black; padding: 2px; width: fit-content;"> Sensed Distance XX.X mm* </div>	<p>Run Auto-Cal is successfully completed when the Sensed Distance displayed correctly matches that of the installed media. When Gap is selected, the Sensed Distance will be representative of the length from the trailing edge of one gap to the trailing edge of the next gap (one label + one gap). When Mark is selected, the Sensed Distance will represent the length form the leading edge of one eye-mark to the leading edge of the next eye-mark. Run Auto-Cal supports label lengths up to 24 inches.</p>

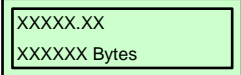
ADVANCED MODE (TABLE 4-3)	
MENU	DESCRIPTION
<div style="border: 1px solid black; padding: 2px; width: fit-content; margin: auto;"> ADVANCED MODE Run Profile </div>	<p>This feature provides a graphical printout showing the relationship of the Paper-Out Threshold and the Gap/Mark Threshold. The profile printed is to assist in setting the thresholds for difficult media (preprinted labels and labels with poor gap/media dynamic range).</p> <p>When selected, the printer will advance media and print the media profile along the length of each label. The factory default is Print Profile.</p>
<div style="border: 1px solid black; padding: 2px; width: fit-content; margin: auto;"> Media Profile Enter to Stop </div>	<p>Displays while the printer is printing the media profile. Will continue to print until the ENTER key is pressed.</p>
<div style="border: 1px solid black; padding: 2px; width: fit-content; margin: auto;"> ADVANCED MODE Power Saver Time </div>	<p>Permits entry into the Power Saver Time sub-menus.</p>
<div style="border: 1px solid black; padding: 2px; width: fit-content; margin: auto;"> Power Saver Time 15 minutes* </div>	<p>The user specified time interval for this parameter sets the amount of idle time before the printer goes into Power Saver Mode. Pressing any key or sending a print job removes the power saver message from the LCD.</p> <p>The options are 1, 5, 10, 15, 30, 45, 60, and 240 minutes. The factory default is 15 minutes.</p>
<div style="border: 1px solid black; padding: 2px; width: fit-content; margin: auto;"> Pwr Save Control Enable* </div>	<p>Permit the Power Saver mode to be enabled or disabled as preferred.</p> <ul style="list-style-type: none"> • Enable - factory default. Permits the setting from the Power Saver Time menu to become effective. • Disable - the power saver feature will not function.
<div style="border: 1px solid black; padding: 2px; width: fit-content; margin: auto;"> Display Language English* </div>	<p>This menu permits the language to be chosen that will appear on the operator panel LCD. The language options are: English, German, French, Italian, Spanish, or Portugese.</p> <p>The factory default is English.</p>
<div style="border: 1px solid black; padding: 2px; width: fit-content; margin: auto;"> Alarm On* </div>	<p>The printer has an integrated audible alarm that may be enabled to alert the user of detected faults. The manner of audible may also be determined in this menu.</p> <ul style="list-style-type: none"> • On - factory default. The audible alarm sounds 3 beeps when a fault occurs. • Cont. Beep - the audible alarm emits a continuous beep upon the detection of a fault. • Off - the audible alarm feature is disabled. Sound is not emitted upon a fault detection.
<div style="border: 1px solid black; padding: 2px; width: fit-content; margin: auto;"> Set Calendar MM/DD/YY hh:mm </div>	<p>This menu screen will only appear if the real-time clock chip has been installed. If installed, the menu will allow the time and date to be set. The time and date is expressed in hh:mm YYYYMMDD.</p> <p>hh = hour, mm = minute, MMM = month, DD = day, YYYY = year</p>
<div style="border: 1px solid black; padding: 2px; width: fit-content; margin: auto;"> Auto Online Enable* </div>	<p>Allows the determination of whether the printer will automatically power up in the online state.</p> <ul style="list-style-type: none"> • Enable - factory default. The printer powers up in the online state. • Disable - the printer powers up in the state that conditions dictate.
<div style="border: 1px solid black; padding: 2px; width: fit-content; margin: auto;"> Cancel Key Enable* </div>	<p>Permits the determination of whether a cancel key may be used in the offline mode to clear all data in the print buffer. The deleted data will not be printed. If enabled, the cancel key located on the host computer keyboard shall be the underscore (_) key.</p> <ul style="list-style-type: none"> • Enable - factory default. The cancel key is functional. • Disable - the cancel key is not functional.

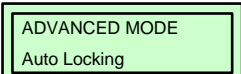
ADVANCED MODE (TABLE 4-3)	
MENU	DESCRIPTION
<div style="border: 1px solid black; padding: 5px; width: fit-content;"> Ret. Status Port Disable </div>	<p>This option selects the port for the Return Status Commands (i.e., ~STATUS (PGL) and ~HS (PPI/ZGL)) to send the status back to the host.</p> <p>The options are Serial, E-NET Stat Port, USB, IEEE 1284, Disable, E-NET Data Port.</p> <p>Serial is the factory default.</p>
<div style="border: 1px solid black; padding: 5px; width: fit-content;"> ADVANCED MODE Del Char frm F1s Ld Char from F1s Save Char from F1s Del Char frm RAM Ld Char at PwrUp Del Set frm F1s Ld Set from F1s Save Set to F1s Del Set from RAM Ld Set at PwrUp Main FFS Optimize&Reboot </div>	<p>Each option when selected, permits the deletion, loading, or saving of characters or overlay sets to/from flash memory or Ram.</p> <ul style="list-style-type: none"> • Del Char frm F1s - deletes downloaded character(s) from flash memory. • Ld Char from F1s - loads downloaded character(s) from flash memory. • Save Char from F1s - saves downloaded character(s) to flash memory. • Del Char frm RAM - deletes downloaded character(s) from RAM. • Ld Char at PwrUp - loads downloaded character(s) from flash memory at power up. Can enable or disable. Disable is the factory default. • Del Set frm F1s - deletes downloaded overlay set(s) from flash memory. • Ld Set from F1s - loads downloaded overlay set(s) from flash memory. • Save Set to F1s - saves downloaded overlay set(s) to flash memory. • Del Set from RAM - seletes downloaded overlay set(s) from RAM. • Ld Set at PwrUp - loads downloaded overlay set(s) from flash memory at power up. Can enable or disable. Disable is the factory default. • Main FFS - • Optimize&Reboot - reclaims flash space from deleted flash files. After pressing the ENTER key on the printer's operator panel, wiat for the printer to reboot. Will optimize both the Main and Extd file system if present.
<div style="border: 1px solid black; padding: 5px; width: fit-content;"> MAIN FFS Overwrite Files View Main Files Delete Files Flash Avail. </div>	<p>Main Flash File System.</p> <ul style="list-style-type: none"> • Overwrite Files - factory default. This option prevents files in the main file system from being overwritten by disabling the overwrite function. • View Main Files - displays a list of files in the main file system. Pressing ENTER on the printer's operator panel display file size. • Delete Files - allows deletion of files in the main file list. Contact your adminstrator for assistance. • Flash Avail. - displays the amount of flash memory available to save or download files into main flash.
<div style="border: 1px solid black; padding: 5px; width: fit-content;"> View Main Files XXXXX.XX </div>	<p>Is the screen that appears if the View Main Files option is selected from the MAIN FFS menu screen. Displays the list of files in the main file system.</p>
<div style="border: 1px solid black; padding: 5px; width: fit-content;"> XXXXX.XX XXXXXX Bytes </div>	<p>Is the screen that appears if the Flash Avail. option is selected from the MAIN FFS menu screen. Displays the amount of flash memory available to save or download files into flash.</p>

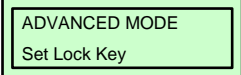
ADVANCED MODE (TABLE 4-3)	
MENU	DESCRIPTION
	<p>Extended Memory Card - Flash File System</p> <ul style="list-style-type: none"> • Overwrite Files - factory default. This option prevents files in the extended file system from being overwritten by disabling the overwrite function. • View Main Files - displays a list of files in the extended file system. Pressing ENTER on the printer's operator panel display file size. • Delete Files - allows deletion of files in the extended file list. Contact your administrator for assistance. • Flash Avail. - displays the amount of flash memory available to save or download files into extended flash.
	<p>Is the screen that appears if the View EMC Files option is selected from the EMC FFS menu screen. Displays the list of files in the extended file system.</p>
	<p>Is the screen that appears if the Flash Avail. option is selected from the EMC FFS menu screen. Displays the amount of flash memory available to save or download files into extended flash.</p>
	<p>Prints a summary of the files stored in extended flash memory and several statistics on file system usage.</p>
	<p>Is a menu option within the main menu of the ADVANCED MODE and allows advancement to the Auto Locking sub-menu to be enabled or disabled as desired.</p>
	<p>Is the sub-menu of the Auto Locking feature.</p> <ul style="list-style-type: none"> • Disable - factory default. The ENTER key of the printer's operator panel must be manually locked. • Enable - the printer automatically locks the ENTER key 5 minutes after the last operator panel key is pressed.
	<p>Is a menu option within the main menu of the ADVANCED MODE and allows advancement to the Set Lock Key sub-menu to select a lock key.</p> <p>Normally, the down arrow key and the ENTER key is pressed simultaneously to lock or unlock the printer menu. This set of menus allows a personal choice of operator panel keys for this purpose as long as they are not already used for another function. There is not a limit on how many keys can be selected.</p>

ADVANCED MODE (TABLE 4-3)	
MENU	DESCRIPTION
<div style="border: 1px solid black; padding: 5px; width: fit-content; margin: auto;"> Select a new lock key </div>	<p>Is the sub-menu of the Set Lock Key feature.</p> <p>When this menu is displayed, simultaneously press the combination of keys desired to be the new lock keys.</p> <p>If the entry is valid, the display will read "Enter the new lock key again". Accurately repeat the entry and "Lock key has been changed" will appear. In case of an error in the second entry, "Validation Failed" will appear and the process must be begun again.</p> <p>If the entry was invalid, the display will read "Invalid key selection" and another set of keys will have to be chosen.</p> <p>The new lock key designation will remain in effect even if the printer is powered off and then on again. Press the FUNCTION key to exit the Advanced Mode.</p>
<div style="border: 1px solid black; padding: 5px; width: fit-content; margin: auto;"> ADVANCED MODE Max Font Buffer </div>	<p>Is a menu option within the main menu of the ADVANCED MODE and allows advancement to the Max Font Buffer sub-menu.</p>
<div style="border: 1px solid black; padding: 5px; width: fit-content; margin: auto;"> Max Font Buffer 100 KBytes* </div>	<p>Allows selection of the maximum amount of DRAM to be allocated for downloading fonts (TrueType, Scalable, Bit-Map). The range is from 100 to 800 KBytes. Factory default is 100 KBytes.</p>
<div style="border: 1px solid black; padding: 5px; width: fit-content; margin: auto;"> Max Cache Memory 900 KBytes* </div>	<p>Maximum Cache Memory. This option specifies the size of the memory block that can be allocated to the font cache. The font cache stores bitmaps that are created on demand from the font outlines stored on the printer flash. The cache allows the printer to print scalable fonts at optimum speed.</p> <p>To calculate the memory requirement, use the following equation:</p> $\text{(HS x VS x Average Height x Average Width x NumOf Char)/8}$ <p>HS = horizontal resolution, VS = vertical resolution, Average Height = average character height in inches, Average Width = average character width in inches, NumOf Char = number of characters to be cached.</p> <p>For most applications, the default settings for font memory is acceptable. Therefore, do not change the defaults unless the application requires an uncommon memory configuration.</p>
<div style="border: 1px solid black; padding: 5px; width: fit-content; margin: auto;"> Max Cached Char 01 KBytes* </div>	<p>Maximum Cached Characters. This option specifies the size of the largest character that can be stored in the font cache. To calculate the memory requirement, use this equation:</p> $\text{(HS x VS x Average Height x Average Width)/8}$ <p>HS = average character height in inches, VS = vertical resolution, Average Height = average character height in inches, Average Width = average character width in inches, NumOf Char = number of characters to be cached.</p> <p>For most applications, the default settings for font memory is acceptable. Therefore, do not change the defaults unless the application requires an uncommon memory configuration.</p>
<div style="border: 1px solid black; padding: 5px; width: fit-content; margin: auto;"> Standard Chars. 340* </div>	<p>This menu entry permits the thickness or font weight of standard text fonts to be adjusted. The range is 0 to 512, and the factory default is 340.</p>
<div style="border: 1px solid black; padding: 5px; width: fit-content; margin: auto;"> Bold Chars. 448* </div>	<p>This menu entry permits the thickness or font weight of bold text fonts to be adjusted. The range is 0 to 512, and the factory default is 448.</p>

ADVANCED MODE (TABLE 4-3)	
MENU	DESCRIPTION
<div style="border: 1px solid black; padding: 2px; width: fit-content; margin: auto;"> Extra Bold Char. 504* </div>	<p>This menu entry permits the thickness or font weight of extra bold text fonts to be adjusted. The range is 0 to 512, and the factory default is 504.</p> <p>For most applications, the default settings for font memory is acceptable. Therefore, do not change the defaults unless the application requires an uncommon memory configuration.</p>
<div style="border: 1px solid black; padding: 2px; width: fit-content; margin: auto;"> OCR-A Chars. 384* </div>	<p>Permits character weight adjustment of resident OCR-A characters. The allowed range is 0 to 512, and the factory default is 384.</p>
<div style="border: 1px solid black; padding: 2px; width: fit-content; margin: auto;"> OCR-B Chars. 304* </div>	<p>Permits character weight adjustment of resident OCR-A characters. The allowed range is 0 to 512, and the factory default is 304.</p>
<div style="border: 1px solid black; padding: 2px; width: fit-content; margin: auto;"> Tall Characters Disable* </div>	<p>Increases the point height of resident Intellifont characters.</p> <ul style="list-style-type: none"> • Disable - factory default. Standard resident font character height is maintained. • Enable - increases the point height by approximately 10%.
<div style="border: 1px solid black; padding: 2px; width: fit-content; margin: auto;"> Batch Counter Disable* </div>	<p>Permits the display of the quantity of pages remaining in a print job.</p> <ul style="list-style-type: none"> • Enable - factory default. Will display on the operator panel LCD. Is only supported in PGL and ZGL. If the correct execute command is absent from the print file, "0 Pages" will continually display. • Disable - the quantity of pages remaining to be printed will not display. Instead, the Active emulation and interface will display on the operator panel LCD.
<div style="border: 1px solid black; padding: 2px; width: fit-content; margin: auto;"> ADVANCED MODE Disp. Intensity </div>	<p>Display Intensity. Is a menu option within the main menu of the ADVANCED MODE and allows advancement to the Disp. Intensity sub-menu.</p>
<div style="border: 1px solid black; padding: 2px; width: fit-content; margin: auto;"> Disp. Intensity 8* </div>	<p>Display Intensity. Allows the light intensity of the operator panel LCD to be adjusted. The allowable range is 0 to 20, the factory default is 10.</p>
<div style="border: 1px solid black; padding: 2px; width: fit-content; margin: auto;"> SENSOR SETUP Sensed Distance </div>	<p>Is the first menu screen of the Sensor Setup portion of the ADVANCED MODE. The sub-menus to follow allow values and settings to be established relative to the printers media sensors.</p>
<div style="border: 1px solid black; padding: 2px; width: fit-content; margin: auto;"> Sensed Distance XX.X mm </div>	<p>This value represents in inches, the distance that was sensed between the top-of-form of one label to the top-of-form of the next label. With gapped media loaded, the distance equals the physical label length plus one gap, notch, or hole (trailing edge to trailing edge).</p> <p>With eye-mark media loaded, the distance equals the leading edge of one eye-mark to the leading edge of the next eye-mark. This value is automatically determined only after successful completion of Auto or Manual Calibrate and cannot be manually changed. The factory default is 0.00 inches.</p>

ADVANCED MODE (TABLE 4-3)	
MENU	DESCRIPTION
<div style="border: 1px solid black; padding: 2px; width: fit-content;">Gap/Mark Thresh XXX*</div>	<p>This menu sets a value that when exceeded by the output of the media sensor, is recognized by the printer as a gap or eye-mark. When Auto or Manual Paper Calibrate is performed, the value displayed is equal to the gap/eye-mark threshold value set by this procedure. If running the procedure does not provide a reliable top-of-form detection (e.g., when using unusual media), the Gap/Mark Thresh value can be manually set to the desired value.</p> <p>The factory default is 171 with a range of 000 to 255.</p> <p>Note: If the Gap/Mark Sensor (in ADVANCED MODE) is set for gap sensing, the factory default is 140. The factory default is 75 for eye-mark sensing.</p>
<div style="border: 1px solid black; padding: 2px; width: fit-content;">Paper Out Thresh XXX*</div>	<p>This menu allows selection of a value that when exceeded by the output of the media sensor, is recognized by the printer as a paper-out condition. When Auto or Manual Calibrate is performed, the value displayed is equal to the paper-out threshold value set by this procedure. If running this procedure does not provide a reliable paper-out detection (e.g., when using non-standard media), the Paper Out Thresh value can be manually set to the desired value.</p> <p>The factory default is 171 with a range of 000 to 255.</p> <p>Note: If the Gap/Mark Sensor (in ADVANCED MODE) is set for gap sensing, the factory default is 160. The factory default is 150 for eye-mark sensing.</p>
<div style="border: 1px solid black; padding: 2px; width: fit-content;">SENSOR SETUP Run Manual Cal</div>	<p>This menu provides another method of improving the printer's media sensing and is only used when Auto Calibrate has failed or the Gap/Mark Threshold or Paper Out Threshold values derived from Auto Calibrate do not improve the media sensors' gap or eye-mark sensing capability.</p>
<div style="border: 1px solid black; padding: 2px; width: fit-content;">REMOVE MEDIA Press Enter</div>	<p>Is the final stage of the Run Manual Cal process. The printer uses the statistically derived values, advances media, stops at the top-of-form position, and momentarily displays the Sensed Distance. When complete, the Gap/Mark threshold, Paper Out Threshold, and the Sensed Distance values the printer will use is changed. These value changes take effect immediately within the current configuration menu.</p>
<div style="border: 1px solid black; padding: 2px; width: fit-content;">LOAD LINER Press Enter</div>	<p>This menu prompts the operator to manually insert just the liner (paper backing) for Gap sensing, or the black bar (eye-mark) for Mark sensing. Ensure that either is underneath sensor prior to pressing the ENTER key of the printer's operator panel.</p>
<div style="border: 1px solid black; padding: 2px; width: fit-content;">LOAD MEDIA Press Enter</div>	<p>This menu prompts the operator to manually insert both the liner (paper backing) with label for Gap sensing, or the black bar (eye-mark) with label for Mark sensing. Ensure that either is underneath sensor prior to pressing the ENTER key of the printer's operator panel.</p>
<div style="border: 1px solid black; padding: 2px; width: fit-content;">SENSOR SETUP Pwr Up Auto-Cal</div>	<p>Is the first menu screen of a sub-menu set within Sensor Setup of the ADVANCED MODE. The sub-menu to follow determines if the printer will perform a self-test and automatic calibration when the printer is powered on.</p>
<div style="border: 1px solid black; padding: 2px; width: fit-content;">Pwr Up Auto-Cal Enable*</div>	<p>Allows determination of whether the printer will perform a self-test and automatic calibration when the printer is powered on. If enabled, once the automatic calibration is complete, the printer will momentarily display the determined Sensed Distance.</p> <ul style="list-style-type: none"> • Enable - factory default. Automatic calibration will be performed at power up initialization. • Disable - automatic calibration will not be performed upon initialization.

ADVANCED MODE (TABLE 4-3)	
MENU	DESCRIPTION
<div style="border: 1px solid black; padding: 2px; width: fit-content;"> Head Auto-Cal Enable* </div>	Head Automatic Calibration. Allows selection of whether the printer performs a media calibration after a Printhead Open fault. <ul style="list-style-type: none"> • Enable - factory default. Performs media calibration each time the fault condition is cleared. • Disable - does not perform media calibration when the fault has been cleared.
<div style="border: 1px solid black; padding: 2px; width: fit-content;"> SENSOR SETUP Online Auto-Cal </div>	Is the first menu screen of a sub-menu set within Sensor Setup of the ADVANCED MODE. The sub-menu to follow determines if online automatic calibration will be enabled or disabled.
<div style="border: 1px solid black; padding: 2px; width: fit-content;"> Online Auto-Cal Disable* </div>	Determines if automatic calibration will occur when the printer is online. Will perform Run Auto-Cal and when complete, the printer will momentarily display the Sensed Distance, then resume printing any pending jobs. <ul style="list-style-type: none"> • Disable - factory default. Automatic calibration will not occur each time the printer is brought online. • Enable - automatic calibration will occur each time the printer is brought online. Note: This feature will not function when there is data in the buffer and when Fault Reprint of the USER MODE is enabled. This feature must also be enabled prior to printing any data.
<div style="border: 1px solid black; padding: 2px; width: fit-content;"> Gap Windowing Disable* </div>	Permits automatic compensation for any media imperfections that may affect the sensor's ability to read reference indicators. <ul style="list-style-type: none"> • Disable - factory default. When the leading edge of a gap is detected, the printer continuously looks for the leading edge of the next label and uses it as the top-of-form position. • Enable - when the leading edge of a gap is detected, the printer ignores the first 90% of the gap length value specified in the Gap Length menu option. The result is that cross perforations or unusual media discrepancies within the gap are filtered out. This allows the printer to reliably detect the actual leading edge of the next label and use it as the top-of-form position. With this option, perforations or unusual media discrepancies within the gap can cause inaccurate top-of-form detection.
<div style="border: 1px solid black; padding: 2px; width: fit-content;"> Gap Length 3 mm* </div>	Allows the actual length (height) of a gap measured in .01 inch increments to be set. The allowable range is 0.05 to 1.00 inches. <p>Note: If an incorrect gap length is set, the image on the label will shift accordingly.</p> The factory default is 0.12 inches.
<div style="border: 1px solid black; padding: 2px; width: fit-content;"> Cal in Peel Mode Disable* </div>	Setting determines if a calibration (Run Auto-Cal or Pwr Up Auto-Cal) will be performed while in the Peel-Off Media Handling mode. <ul style="list-style-type: none"> • Disable - factory default. The printer will not permit calibration and a "CANNOT CALIBRATE/Disable Peel-Off" message will briefly display. Additionally, if PwrUp Auto-Cal is enabled, the printer will not perform calibration at power up. • Enable - Run Auto-Cal can be performed from the operator panel. If the PwrUp Auto-Cal option is enabled, calibration will be performed at power up.
<div style="border: 1px solid black; padding: 2px; width: fit-content;"> Min Calib Delta 020* </div>	Minimum Calibrate Delta. Permits the sensor minimum threshold value that is required to detect the difference between the label and a gap, notch, hole or eye-mark to be changed. This allows bolder gaps to be used as the top-of-form while intermediate gaps are ignored. <p>Increasing the value makes the sensors less sensitive to intermediate gaps or noise. Decreasing the value makes the sensors more sensitive for detecting gaps on low contrast media where there is little difference between the label and the liner.</p> The factory default is 012 with a range of 012 to 050 .

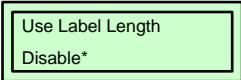
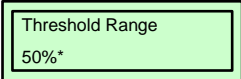
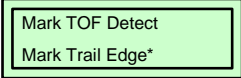
ADVANCED MODE (TABLE 4-3)	
MENU	DESCRIPTION
	<p>Determines if the Label Length value set in the Media Setup menu is used during Run Auto-Cal. Run Auto-Cal relies exclusively in its ability to detect varying transitions between labels and gaps, notches, holes, or eye-marks while advancing media during the calibration process to determine sensed distance. The amount of media advanced is based on the quantity of transitions detected.</p> <p>Although the Use Label Length keeps its value (enable/disable) at all times, it will always be disabled when Set Label Length is set to Automatic. The correct setting will take effect when Set Label Length is set to manual. Based on the setting on the Label Length menu in the USER MODE, the Use Label Length menu will be ignored.</p> <ul style="list-style-type: none"> • Disable - factory default. • Enable - the Label Length value set in the USER MODE is used in the calibrate algorithm. This causes the Run Auto-Cal process to advance media the minimum distance to detect the true gap, notch, hole, or eye-mark used for top-of-form sensing. This resolves problems where the sensors may mistake high noise levels or preprinted images within the label as the reference indicator that could result in a sensed distance value much shorter than the actual label length. Note that setting a Label Length value less than half the actual label length in use will result in erroneous sensed distance values when Run Auto-Cal is performed.
	<p>This option allows the user to select the optimal threshold range for the label stock in use. The printer defaults to using a threshold range of 50% of the positive going pulse that represents each reference indicator detected after doing an Auto or Manual calibrate. the printer then detects anything within the label with that threshold range as top-of-form.</p> <p>While this range is ideal for most medias, some labels with a preprinted image, liner gap or inlay can confuse the media sensors causing a false top-of-form detection. In most cases this can be resolved selecting a higher threshold range so the printer will only trigger on the true top-of-form position.</p> <p>Note: A new threshold range will not take effect until an Auto or Manual Calibate is successfully performed. Run a Media Profile after a Calibrate to visually verify that the new range is the best possible selection.</p> <p>The factory default is 50% with an allowable range of 5 to 95% in 5% increments.</p>
	<p>Mark Top-Of-Form Detect. Allows selection of the point of measure for the start print position to be determined.</p> <ul style="list-style-type: none"> • Mark Trailing Edge - factory default. Printer adjusts the top-of-form to the label's trailing edge. • Mark Leading Edge - printer adjusts the top-of-form to the label's leading edge.

SERIAL INTERFACE MODE (TABLE 4-4)	
MENU	DESCRIPTION
	<p>Permits entry into the INTERFACES Mode.</p>

SERIAL INTERFACE MODE (TABLE 4-4)	
MENU	DESCRIPTION
<div style="border: 1px solid black; padding: 5px; width: fit-content;"> INTERFACES Ignore CR/LF Item No. Check BCC Check History Buffer Comm. Protocol Host Interface Parallel Port USB Port Serial Port Printer Mgt </div>	Is the menu selection screen for the INTERFACES Mode.
<div style="border: 1px solid black; padding: 5px; width: fit-content;"> Ignore CR/LF No* </div>	Determines whether the print data code will be deleted. Hexadecimal graphic data will not be deleted. <ul style="list-style-type: none"> • No - factory default. Will not be deleted. • Yes - will delete all carriage returns (CR) and line feed (LF) commands in the data stream - including graphics and 2D barcodes.
<div style="border: 1px solid black; padding: 5px; width: fit-content;"> Item No. Check Disable* </div>	This menu screen is only available when Status 5 is selected for Bi-Com interface. Determines how the printer will react if the item number (ID Command) is set to be processed by the printer. <ul style="list-style-type: none"> • Disable - factory default. Does nothing regardless of whether the item number is included in the format. • Cancel - errors when the incorrect item number is being accessed. When the printer is brought back online from the error, by pressing the Line key, the incorrect job is canceled. • Resume - errors when the incorrect item number is being accessed. When the printer is brought back online from the error, by pressing the Line key, the incorrect job is canceled.
<div style="border: 1px solid black; padding: 5px; width: fit-content;"> BCC Check Disable* </div>	Block-Check-Code Algorithm Check. Only available when Status 5 is selected for Bi-Com interface. Determines how the printer will react if the BCC is set to be processed by the printer. <ul style="list-style-type: none"> • Disable - factory default. Does nothing regardless of whether the BCC is included in the format. • Cancel - errors when the incorrect BCC is being accessed. When the printer is brought back online from an error, by pressing the Line key, the incorrect job is printed. • Resume - error when the incorrect item number is being accessed. When the printer is brought back online from the error, by pressing the Line key, the incorrect job is canceled.
<div style="border: 1px solid black; padding: 5px; width: fit-content;"> History Buffer Temporary* </div>	The history buffer stores a history of printer statuses. Is only available when Status 5 is selected for Bi-Com interface. <ul style="list-style-type: none"> • Temporary - factory default. Store the history buffer in the internal RAM. This memory is deleted when the printer's power is turned off. • Permanent - stores the history buffer in Flash (internal or optional) Memory. This memory can only be cleared through the printer's display.
<div style="border: 1px solid black; padding: 5px; width: fit-content;"> Comm. Protocol Status 5* </div>	Communication Protocol. Selects the mode of Bi-Directional communications. In most cases this menu does not need to be altered and is meant to help support legacy applications which may have incorporated older bi-directional statuses. Anything other than Status 5 or Standard (none) is not recommended. <ul style="list-style-type: none"> • Status 5 - factory default. Most advanced of the options. This status is the most recent and represented in the interface specifications. For more information, refer to the appropriate section in the programming and interface guide. • Standard - bi-directional interface is not used. • Status 2 - legacy bi-directional support. Not recommended for new applications. • Status 3 - legacy bi-directional support. Not recommended for new applications. • Status 4 - legacy bi-directional support. Not recommended for new applications.

SERIAL INTERFACE MODE (TABLE 4-4)	
MENU	DESCRIPTION
<div style="border: 1px solid black; padding: 5px;"> Host Interface Serial* </div>	<p>Is the main menu screen for the Host Interface option of the INTERFACES mode. There are only two options relative to the serial interface, ignore all others.</p> <ul style="list-style-type: none"> • Serial - factory default. Allows the operator to select the interface and the relative menus will follow. • Auto Switching - the printer automatically switches to the relative interface type and moves into the applicable menus.
<div style="border: 1px solid black; padding: 5px;"> Serial Port Baud Rate Word Length Stop Bits Parity Data Protocol Buffer Size in K Trickle Time Time Out Report Status Data Term Ready Request to Send Poll Character Poll Response Idle Response One Char Inquiry Printer Status Framing Errors </div>	<p>Is the menu selection screen for the Serial Port option of the INTERFACES mode.</p>
<div style="border: 1px solid black; padding: 5px;"> Baud Rate 19200* </div>	<p>Allows setting the baud rate for the serial interface. The baud rate is the speed serial data is transferred between the host computer and the printer. The options for RS232 and RS422 are 600, 1200, 2400, 4800, 9600, 19200, 38400, 57600, and 115200 baud.</p> <p>Note: If using RS232 and the selected baud rate is greater than 19200, data loss may occur. To correct this, it may be necessary to lower the baud rate or use RS422. An increase in the Buffer Size in K parameter from the default (1 Kbyte) may be required to improve performance.</p> <p>The factory default is 9600.</p>
<div style="border: 1px solid black; padding: 5px;"> Word Length 8* </div>	<p>This menu allows the length of the serial data word to be set. The data word length can be set to 7 or 8 bits and must match the corresponding data bits setting in the host computer.</p> <p>The factory default is 8.</p>
<div style="border: 1px solid black; padding: 5px;"> Stop Bits 1* </div>	<p>This menu allows the quantity of stop bits in the serial word to be set. either 1 or 2 stop bits may be selected, but the setting must match the corresponding stop bit setting in the host computer.</p>
<div style="border: 1px solid black; padding: 5px;"> Parity None* </div>	<p>This menu screen allows the parity to be set, but the setting must match that of the host computer. The options are: Odd, Even, Mark, Sense, or None.</p> <p>The factory default is None.</p>

SERIAL INTERFACE MODE (TABLE 4-4)	
MENU	DESCRIPTION
<div style="border: 1px solid black; padding: 2px; width: fit-content;"> Data Protocol DTR* </div>	<p>Allows the serial interface protocol type to be selected to meet host interface requirements.</p> <ul style="list-style-type: none"> • DTR - The printer controls the data flow by sending this hardware signal to the host. If there is enough room in the printer buffer, the printer will send a high signal; if the buffer is full, the printer will send a low signal. DTR tells the host if it is safe to send more data (if the host sends data during an unsafe condition, data will be lost). DTR is not available when RS422 is selected. • XON/XOFF - factory default. The printer controls the flow of communication from the host by turning the transmission on and off. In some situations, such as when the buffer is full or the timing of signals is too slow/fast, the printer will tell the host to stop transmission by sending an XOFF character. An XOFF character is sent when the quantity of empty bytes in the buffer is less than or equal to 25 percent of the buffer size. If the host keeps sending data after an XOFF is sent, the printer firmware will continue to send an XOFF for every 16 characters received. When cleared, the printer will resume receiving data (XON). The data does not have any End of Text Codes; XON/XOFF is a non-block protocol. • ETX/ACK - End of Text/Acknowledge. The host controls the flow of communication to the printer by sending a block of data and ending the block with an End of Text (ETX) signal. When the printer receives the ETX signal, it acknowledges the ETX, thereby acknowledging it has received the entire block of data. • ACK/NAK - Acknowledge/Negative Acknowledge. When the device acknowledges ACK, it has accepted a transmission. When the device acknowledges NAK, it has not accepted a transmission. • Series1 1 Char - The printer controls the flow of communication from the host by turning the transmission on and off using response characters sent to the host. If the quantity of valid bytes in the buffer reaches 75 percent of the buffer size, the online or offline and buffer full response character is sent. If the buffer is completely full, an online or offline buffer full response is sent every time a character is sent to the host. Whenever the printer state changes to online or offline, the appropriate response character is sent. If the idle response option is enabled, the printer will send a response character every two seconds while the quantity of valid bytes in the buffer is less than 75 percent of the buffer size. If a poll character is received (configurable from the Poll character xx Hex option on the operator panel from the Hex 0 through FF), the printer will send a response character in milliseconds later (configurable from the Poll character xx MS on the operator panel from 0 through 30). This in milliseconds is called the poll delay. The poll character will be removed from the input data stream and will not be processed. This may cause problems with the transmission binary data (e.g., control codes, bit image, etc.). If a poll delay is started due to the receipt of a poll character and another poll character is received, the second poll character has no effect and is removed from the input data stream. If a transmission (from buffer full to empty or online to offline) occurs during a poll delay, the new printer state will be sent at the end of the poll delay. • Series1 2 char - This protocol behaves exactly the same as the Series 1 Char except there is a two-character response to the host.
<div style="border: 1px solid black; padding: 2px; width: fit-content;"> Buffer Size in K 16* </div>	<p>This menu configures the amount of memory allocated for the serial port buffer. The range is 1 to 16 Kbytes in 1 kbyte increments.</p> <p>Note: If a baud rate 19200 or greater is selected, the Buffer Size in K parameter may need to be increased from the default to 16 Kbytes to improve performance.</p> <p>The factory default is 16.</p>

SERIAL INTERFACE MODE (TABLE 4-4)	
MENU	DESCRIPTION
<div style="border: 1px solid black; padding: 2px; width: fit-content;">Trickle Time 1/4 sec*</div>	<p>When the printer is printing data from a host and a second job is received by the printer from a different host, Trickle Time prevents the second host from timing out while waiting for its data to be printed. In order to support this feature, the port has to be able to accept data from the host and store it for future use.</p> <p>For example, the printer is printing a job from the serial port and then receives a second print job from the parallel port, the data from the parallel port will trickle bit by bit into the print buffer to prevent a timeout error from being sent back to the host connected to the parallel port.</p> <p>The selected value should be less than the host timeout value, but not too much shorter or else the printer fills up its buffer too fast. This function is applicable for C/T hotport.</p> <p>the options are 1/4, 1/2, 1, 2, 4, 8, and 16 seconds and Off. The factory default is 1/4.</p>
<div style="border: 1px solid black; padding: 2px; width: fit-content;">Timeout 10 sec*</div>	<p>This is the value used by the printer to time out from the current port and check the other selected Port Types for data print. When the printer has not received data from the host after a certain period of time, it must timeout in order to service other ports.</p> <p>The factory default is 10 seconds with an allowable range of 1 to 60 seconds.</p>
<div style="border: 1px solid black; padding: 2px; width: fit-content;">Report Status Disable*</div>	<p>When a fault condition occurs in the printer, normally only the active port reports the fault to the host. When the Report Status menu option is enabled, the port will report any fault even when it is not the current, active port.</p> <p>The options are Disable and Enable. The factory default is Disable.</p>
<div style="border: 1px solid black; padding: 2px; width: fit-content;">Data Term Ready True*</div>	<p>Data Terminal Ready. This configuration is part of hardware flow control and determines when the Data Terminal Ready (DTR) signal is generated. This signal indicates if the printer is ready to receive data.</p> <ul style="list-style-type: none"> • True - factory default. Continuously asserts the DTR signal. • False - never asserts the DTR signal. • On-Line and BNF - buffer not full. Asserts the DTR signal when the printer is online and the internal serial buffer is not full. • Off-Line or BF - buffer full. Asserts the DTR signal when the printer is offline or the internal serial buffer is full. • On-Line - asserts the DTR signal when the printer is online.
<div style="border: 1px solid black; padding: 2px; width: fit-content;">Request to Send On-Line and BNF*</div>	<p>This configuration is part of hardware flow control and determines when the Request to Send (RTS) signal is generated. This signal indicates whether or not the printer is ready to receive data.</p> <ul style="list-style-type: none"> • On-Line and BNF - factory default. Asserts the RTS signal when the printer is online and the internal serial buffer is not full. • Off-Line or BF - buffer full. Asserts the RTS signal when the printer is offline or the internal serial buffer is full. • On-Line - asserts the RTS signal when the printer is online. • False - never asserts the RTS signal. • True - factory default. Continuously asserts the RTS signal.
<div style="border: 1px solid black; padding: 2px; width: fit-content;">Poll Character 00 Hex*</div>	<p>This option is for the Series1 protocol. Whenever the printer receives this character, it sends a response to the host indicating the current state of the printer (refer to Series1 protocol).</p> <p>The allowable range is 00 to FF Hex, and the factory default is 00 Hex.</p>

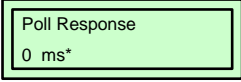
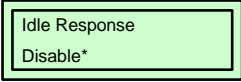
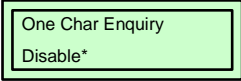
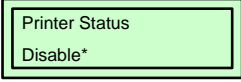
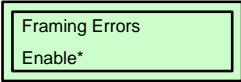
SERIAL INTERFACE MODE (TABLE 4-4)	
MENU	DESCRIPTION
	<p>This option is for the Series1 protocol. After receiving a poll character, the printer will wait the poll response time in milliseconds before sending the response.</p> <p>The allowable range is 0 to 30 ms, and the factory default is 0 ms.</p>
	<p>This option is for the Series1 protocol.</p> <ul style="list-style-type: none"> • Disable - factory default. • Enable - the printer sends a response character every two seconds while the quantity of valid bytes in the buffer is less than 75 percent of the buffer size.
	<p>One Character Enquiry. This mode uses the poll character to detect a request from the host and sends a response back to the host.</p> <ul style="list-style-type: none"> • Disable - factory default. Poll character will not detect. • Enable - poll character will detect.
	<p>If enabled, allows the printer to respond according to two different response tables when an ENQ command is sent to the printer.</p> <ul style="list-style-type: none"> • Disable - factory default. A response is not sent. • ENQ/STX - when the printer receives an ENQ, the printer responds with a status according to ENQ/STX parameters. • ENQ - when the printer receives an ENQ, the printer responds with a status according to ENQ parameters.
	<p>These are possible errors that can occur when serial interface settings of the printer do not match those of the host computer.</p> <ul style="list-style-type: none"> • Enable - factory default. If a framing error occurs, a fault message will display on the operator panel. • Disable - if a framing error occurs, a fault message will not display on the operator panel.

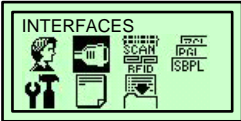
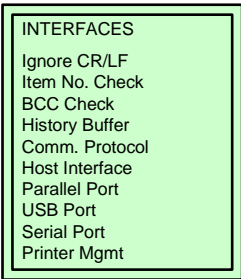

PARALLEL INTERFACE MODE (TABLE 4-5)	
MENU	DESCRIPTION
	<p>Permits entry into the INTERFACES Mode.</p>
	<p>Is the menu selection screen for the INTERFACES Mode.</p>

PARALLEL INTERFACE MODE (TABLE 4-5)	
MENU	DESCRIPTION
<div style="border: 1px solid black; padding: 5px; width: fit-content;">Ignore CR/LF No*</div>	<p>Determines whether the print data code will be deleted. Hexadecimal graphic data will not be deleted.</p> <ul style="list-style-type: none"> • No - factory default. Will not be deleted. • Yes - will delete all carriage returns (CR) and line feed (LF) commands in the data stream - including graphics and 2D barcodes.
<div style="border: 1px solid black; padding: 5px; width: fit-content;">Item No. Check Disable*</div>	<p>This menu screen is only available when Status 5 is selected for Bi-Com interface. Determines how the printer will react if the item number (ID Command) is set to be processed by the printer.</p> <ul style="list-style-type: none"> • Disable - factory default. Does nothing regardless of whether the item number is included in the format. • Cancel - errors when the incorrect item number is being accessed. When the printer is brought back online from the error, by pressing the Line key, the incorrect job is canceled. • Resume - error when the incorrect item number is being accessed. When the printer is brought back online from the error, by pressing the Line key, the incorrect job is canceled.
<div style="border: 1px solid black; padding: 5px; width: fit-content;">BCC Check Disable*</div>	<p>Block-Check-Code Algorithm Check. Only available when Status 5 is selected for Bi-Com interface. Determines how the printer will react if the BCC is set to be processed by the printer.</p> <ul style="list-style-type: none"> • Disable - factory default. Does nothing regardless of whether the BCC is included in the format. • Cancel - errors when the incorrect BCC is being accessed. When the printer is brought back online from an error, by pressing the Line key, the incorrect job is printed. • Resume - error when the incorrect item number is being accessed. When the printer is brought back online from the error, by pressing the Line key, the incorrect job is canceled.
<div style="border: 1px solid black; padding: 5px; width: fit-content;">History Buffer Temporary*</div>	<p>The history buffer stores a history of printer statuses. Is only available when Status 5 is selected for Bi-Com interface.</p> <ul style="list-style-type: none"> • Temporary - factory default. Store the history buffer in the internal RAM. This memory is deleted when the printer's power is turned off. • Permanent - stores the history buffer in Flash (internal or optional) Memory. This memory can only be cleared through the printer's display.
<div style="border: 1px solid black; padding: 5px; width: fit-content;">Comm. Protocol Status 5*</div>	<p>Communication Protocol. Selects the mode of Bi-Directional communications. In most cases this menu does not need to be altered and is meant to help support legacy applications which may have incorporated older bi-directional statuses. Anything other than Status 5 or Standard (none) is not recommended.</p> <ul style="list-style-type: none"> • Status 5 - factory default. Most advanced of the options. This status is the most recent and represented in the interface specifications. For more information, refer to the appropriate section in the programming and interface guide. • Standard - bi-directional interface is not used. • Status 2 - legacy bi-directional support. Not recommended for new applications. • Status 3 - legacy bi-directional support. Not recommended for new applications. • Status 4 - legacy bi-directional support. Not recommended for new applications.
<div style="border: 1px solid black; padding: 5px; width: fit-content;">Host Interface Auto Switching*</div>	<p>Is the main menu screen for the Host Interface option of the INTERFACES mode. There are only two options relative to the serial interface, ignore all others.</p> <ul style="list-style-type: none"> • Auto Switching - the printer automatically switches to the relative interface type and moves into the applicable menus. • Parallel - factory default. Allows the operator to select the interface and the relative menus will follow.

PARALLEL INTERFACE MODE (TABLE 4-5)	
MENU	DESCRIPTION
<div style="border: 1px solid black; padding: 5px; width: fit-content;"> Parallel Port Port Type </div>	Is the menu selection screen for the Parallel Port option of the INTERFACES mode.
<div style="border: 1px solid black; padding: 5px; width: fit-content;"> Port Type IEEE 1284* </div>	This menu allows selection of the type of printer parallel port interface to be used with the host. IEEE1284 is the default and the only option applicable to the parallel interface.
<div style="border: 1px solid black; padding: 5px; width: fit-content;"> Buffer Size in K 16* </div>	<p>This menu configures the amount of memory allocated for the parallel port buffer. The range is 1 to 16 Kbytes in 1 kbyte increments.</p> <p>Note: If a baud rate 19200 or greater is selected, the Buffer Size in K parameter may need to be increased from the default to 16 Kbytes to improve performance.</p> <p>The factory default is 16.</p>
<div style="border: 1px solid black; padding: 5px; width: fit-content;"> Auto Trickle Disable* </div>	<p>This feature is used to prevent a host computer from timing out because the parallel interface is busy for too long.</p> <ul style="list-style-type: none"> • Enable - factory default. When the printer's buffers are almost full, the printer begins to trickle data in from the host (at the rate set in the Trickle Time menu) until the buffers start to empty. • Disable - is not used.
<div style="border: 1px solid black; padding: 5px; width: fit-content;"> Trickle Time 1/4 sec* </div>	<p>When the printer is printing data from a host and a second job is received by the printer from a different host, Trickle Time prevents the second host from timing out while waiting for its data to be printed. In order to support this feature, the port has to be able to accept data from the host and store it for future use.</p> <p>For example, the printer is printing a job from the serial port and then receives a second print job from the parallel port, the data from the parallel port will trickle bit by bit into the print buffer to prevent a timeout error from being sent back to the host connected to the parallel port.</p> <p>The selected value should be less than the host timeout value, but not too much shorter or else the printer fills up its buffer too fast. This function is applicable for C/T hotport.</p> <p>The options are 1/4, 1/2, 1, 2, 4, 8, and 16 seconds and Off. The factory default is 1/4.</p>
<div style="border: 1px solid black; padding: 5px; width: fit-content;"> Timeout 10 sec.* </div>	<p>This is the value used by the printer to time out from the current port and check the other selected Port Types for data print. When the printer has not received data from the host after a certain period of time, it must timeout in order to service other ports.</p> <p>The factory default of 10 seconds with an allowable range of 1 to 60 seconds.</p>
<div style="border: 1px solid black; padding: 5px; width: fit-content;"> Report Status Disable* </div>	<p>When a fault condition occurs in the printer, normally only the active port reports the fault to the host. When the Report Status menu option is enabled, the port will report any fault even when it is not the current, active port.</p> <p>The options are Disable and Enable. The factory default is Disable.</p>
<div style="border: 1px solid black; padding: 5px; width: fit-content;"> IEEE 1284 Prime Signal </div>	Is a menu subset of the IEEE1284 option. Will move into the Prime Signal menu to enable or disable the option.
<div style="border: 1px solid black; padding: 5px; width: fit-content;"> Prime Signal Disable* </div>	<p>Is a normally low signal on the parallel port. When initiated, it is designed to reset the parallel port and clear the printer buffer.</p> <ul style="list-style-type: none"> • Disable - factory default. No action when the signal is initiated by the host. • Enable - reboots interface and clears the printer buffer when the signal is asserted.

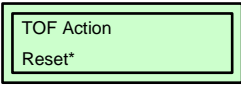
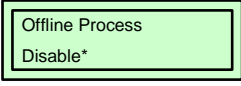
Unit 4: Printer Configuration

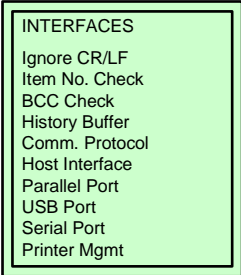
PARALLEL INTERFACE MODE (TABLE 4-5)	
MENU	DESCRIPTION
	<p>Top-Of-Form Action. When enabled, the printer will feed out the job in process when the prime signal is activated through the parallel interface. If disabled, the job in process may be aborted.</p>
	<p>Allows determination of whether the printer will process data while offline.</p> <ul style="list-style-type: none"> • Disable - factory default. The printer does not process parallel/network data while offline. • Enable - the printer continues to process (but not print) the current network/parallel job while the printer is offline until the printer's buffer is full.

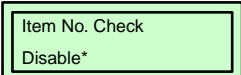
CENTRONICS INTERFACE MODE (TABLE 4-6)	
MENU	DESCRIPTION
	<p>Permits entry into the INTERFACES Mode.</p>
	<p>Is the menu selection screen for the INTERFACES Mode.</p>
	<p>Determines whether the print data code will be deleted. Hexadecimal graphic data will not be deleted.</p> <ul style="list-style-type: none"> • No - factory default. Will not be deleted. • Yes - will delete all carriage returns (CR) and line feed (LF) commands in the data stream - including graphics and 2D barcodes.
	<p>This menu screen is only available when Status 5 is selected for Bi-Com interface. Determines how the printer will react if the item number (ID Command) is set to be processed by the printer.</p> <ul style="list-style-type: none"> • Disable - factory default. Does nothing regardless of whether the item number is included in the format. • Cancel - errors when the incorrect item number is being accessed. When the printer is brought back online from the error, by pressing the Line key, the incorrect job is canceled. • Resume - error when the incorrect item number is being accessed. When the printer is brought back online from the error, by pressing the Line key, the incorrect job is canceled.



CENTRONICS INTERFACE MODE (TABLE 4-6)	
MENU	DESCRIPTION
<div style="border: 1px solid black; padding: 2px; width: fit-content; margin: auto;"> BCC Check Disable* </div>	<p>Block-Check-Code Algorithm Check. Only available when Status 5 is selected for Bi-Com interface. Determines how the printer will react if the BCC is set to be processed by the printer.</p> <ul style="list-style-type: none"> • Disable - factory default. Does nothing regardless of whether the BCC is included in the format. • Cancel - errors when the incorrect BCC is being accessed. When the printer is brought back online from an error, by pressing the Line key, the incorrect job is printed. • Resume - error when the incorrect item number is being accessed. When the printer is brought back online from the error, by pressing the Line key, the incorrect job is canceled.
<div style="border: 1px solid black; padding: 2px; width: fit-content; margin: auto;"> History Buffer Temporary* </div>	<p>The history buffer stores a history of printer statuses. Is only available when Status 5 is selected for Bi-Com interface.</p> <ul style="list-style-type: none"> • Temporary - factory default. Store the history buffer in the internal RAM. This memory is deleted when the printer's power is turned off. • Permanent - stores the history buffer in Flash (internal or optional) Memory. This memory can only be cleared through the printer's display.
<div style="border: 1px solid black; padding: 2px; width: fit-content; margin: auto;"> Comm. Protocol Status 5* </div>	<p>Communication Protocol. Selects the mode of Bi-Directional communications. In most cases this menu does not need to be altered and is meant to help support legacy applications which may have incorporated older bi-directional statuses. Anything other than Status 5 or Standard (none) is not recommended.</p> <ul style="list-style-type: none"> • Status 5 - factory default. Most advanced of the options. This status is the most recent and represented in the interface specifications. For more information, refer to the appropriate section in the programming and interface guide. • Standard - bi-directional interface is not used. • Status 2 - legacy bi-directional support. Not recommended for new applications. • Status 3 - legacy bi-directional support. Not recommended for new applications. • Status 4 - legacy bi-directional support. Not recommended for new applications.
<div style="border: 1px solid black; padding: 2px; width: fit-content; margin: auto;"> Host Interface Auto Switching* </div>	<p>Is the main menu screen for the Host Interface option of the INTERFACES mode. There are only two options relative to the serial interface, ignore all others.</p> <ul style="list-style-type: none"> • Auto Switching - the printer automatically switches to the relative interface type and moves into the applicable menus. • Centronics - factory default. Allows the operator to select the interface and the relative menus will follow.
<div style="border: 1px solid black; padding: 2px; width: fit-content; margin: auto;"> Parallel Port Port Type </div>	<p>Is the menu selection screen for the Parallel Port option of the INTERFACES mode.</p>
<div style="border: 1px solid black; padding: 2px; width: fit-content; margin: auto;"> Port Type Centronics </div>	<p>Is a submenu that allows the Centronics interface to be chosen.</p>
<div style="border: 1px solid black; padding: 2px; width: fit-content; margin: auto;"> CENTRONICS Data Bit 8 </div>	<p>Is a menu set that permits entry into the Data Bit 8 enable/disable menu.</p>

CENTRONICS INTERFACE MODE (TABLE 4-6)	
MENU	DESCRIPTION
<div style="border: 1px solid black; padding: 2px; width: fit-content; margin: auto;">Data Bit 8 Enable*</div>	<p>Is typically for a line-printer and should not normally be enabled. Is used for legacy applications which interpret the 8th data bit line as a PI signal.</p> <ul style="list-style-type: none"> • Enable - factory default. The PI line is not passed directly from the host to printer; all 8 bits are used for data bits. Characters in the Hex 80 to FF range can be accessed. • Disable - when the PI line is enabled, data bit 8 internally indicates PI line status. To use the PI line, disable data bit 8 and enable the Host PI configuration option (under PI Ignored option).
<div style="border: 1px solid black; padding: 2px; width: fit-content; margin: auto;">PI Ignored Enable*</div>	<p>Paper Instruction Ignored. This signal is used to control vertical paper motion.</p> <ul style="list-style-type: none"> • Enable - factory default. Ignores the PI signal and treats the data as characters or control codes. • Disable - causes the printer to interpret the eight data lines as VFU commands when the PI signal is true.
<div style="border: 1px solid black; padding: 2px; width: fit-content; margin: auto;">Data Polarity Standard*</div>	<p>This parameter must be set to match the response polarity of the host computer.</p> <ul style="list-style-type: none"> • Standard - factory default. Does not expect the host computer to invert data. • Inverted - expects the data received on the data lines from the host computer to be inverted. One become zeros and vice versa.
<div style="border: 1px solid black; padding: 2px; width: fit-content; margin: auto;">Resp. Polarity Standard*</div>	<p>Response Polarity. This parameter must be set to match the response polarity of the host computer.</p> <ul style="list-style-type: none"> • Standard - factory default. Does not invert the response to the host computer. • Inverted - inverts the response signal sent to the host computer.
<div style="border: 1px solid black; padding: 2px; width: fit-content; margin: auto;">Busy on Strobe Enable*</div>	<p>The strobe signal tells the printer when to look for data on the data lines. The printer can either be set to assert a busy signal after each data byte or after the printer's buffer has filled.</p> <ul style="list-style-type: none"> • Enable - factory default. Asserts a busy signal after each character is received. • Disable - asserts a busy signal only when the print buffers are full.
<div style="border: 1px solid black; padding: 2px; width: fit-content; margin: auto;">Latch Data On Leading*</div>	<p>Specifies whether the data is read on the leading or trailing edge of the data strobe signal. The options are Leading and Trailing. Leading is the factory default.</p>
<div style="border: 1px solid black; padding: 2px; width: fit-content; margin: auto;">Prime Signal Disable*</div>	<p>Is a normally low signal on the parallel port. When initiated, it is designed to reset the parallel port and clear the printer buffer.</p> <ul style="list-style-type: none"> • Disable - factory default. No action when the signal is initiated by the host. • Enable - reboots interface and clears the printer buffer when the signal is asserted.
<div style="border: 1px solid black; padding: 2px; width: fit-content; margin: auto;">TOF Action Reset*</div>	<p>Top-Of-Form Action. When enabled, the printer will feed out the job in process when the prime signal is activated through the Centronics interface. If disabled, the job in process may be aborted.</p> <p>Regardless of this menu, the prime signal will also reset the printer.</p>
<div style="border: 1px solid black; padding: 2px; width: fit-content; margin: auto;">Buffer Size in K 16*</div>	<p>This menu configures the amount of memory allocated for the serial port buffer. The range is 1 to 16 Kbytes in 1 kbyte increments.</p> <p>Note: If a baud rate 19200 or greater is selected, the Buffer Size in K parameter may need to be increased from the default to 16 Kbytes to improve performance.</p> <p>The factory default is 16.</p>

CENTRONICS INTERFACE MODE (TABLE 4-6)	
MENU	DESCRIPTION
<div style="border: 1px solid black; padding: 5px; width: fit-content;"> Auto Trickle Disable* </div>	<p>This feature is used to prevent a host computer from timing out because the parallel interface is busy for too long.</p> <ul style="list-style-type: none"> • Enable - factory default. When the printer's buffers are almost full, the printer begins to trickle data in from the host (at the rate set in the Trickle Time menu) until the buffers start to empty. • Disable - is not used.
<div style="border: 1px solid black; padding: 5px; width: fit-content;"> Trickle Time 1/4 sec* </div>	<p>When the printer is printing data from a host and a second job is received by the printer from a different host, Trickle Time prevents the second host from timing out while waiting for its data to be printed. In order to support this feature, the port has to be able to accept data from the host and store it for future use.</p> <p>For example, the printer is printing a job from the serial port and then receives a second print job from the parallel port, the data from the parallel port will trickle bit by bit into the print buffer to prevent a timeout error from being sent back to the host connected to the parallel port.</p> <p>The selected value should be less than the host timeout value, but not too much shorter or else the printer fills up its buffer too fast. This function is applicable for C/T hotport.</p> <p>The options are 1/4, 1/2, 1, 2, 4, 8, and 16 seconds and Off. The factory default is 1/4.</p>
<div style="border: 1px solid black; padding: 5px; width: fit-content;"> Timeout 10 sec.* </div>	<p>This is the value used by the printer to time out from the current port and check the other selected Port Types for data print. When the printer has not received data from the host after a certain period of time, it must timeout in order to service other ports.</p> <p>The factory default of 10 seconds with an allowable range of 1 to 60 seconds.</p>
<div style="border: 1px solid black; padding: 5px; width: fit-content;"> Report Status Disable* </div>	<p>When a fault condition occurs in the printer, normally only the active port reports the fault to the host. When the Report Status menu option is enabled, the port will report any fault even when it is not the current, active port.</p> <p>The options are Disable and Enable. The factory default is Disable.</p>
<div style="border: 1px solid black; padding: 5px; width: fit-content;"> Offline Process Disable* </div>	<p>Allows determination of whether the printer will process data while offline.</p> <ul style="list-style-type: none"> • Disable - factory default. The printer does not process parallel/network data while offline. • Enable - the printer continues to process (but not print) the current network/parallel job while the printer is offline until the printer's buffer is full.

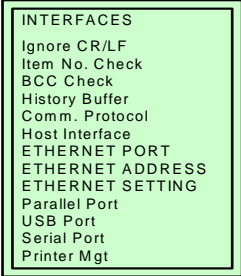
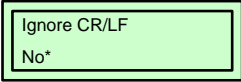
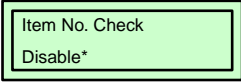
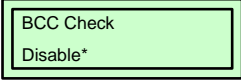
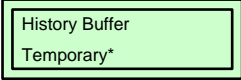
UNIVERSAL SERIAL BUS (USB) INTERFACE MODE (TABLE 4-7)	
MENU	DESCRIPTION
<div style="border: 1px solid black; padding: 5px; width: fit-content;">  </div>	<p>Permits entry into the INTERFACES Mode.</p>

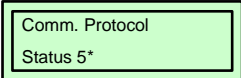
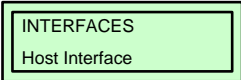
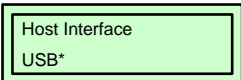
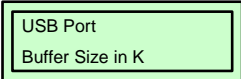
UNIVERSAL SERIAL BUS (USB) INTERFACE MODE (TABLE 4-7)	
MENU	DESCRIPTION
	<p>Is the menu selection screen for the INTERFACES Mode.</p>
	<p>Determines whether the print data code will be deleted. Hexadecimal graphic data will not be deleted.</p> <ul style="list-style-type: none"> • No - factory default. Will not be deleted. • Yes - will delete all carriage returns (CR) and line feed (LF) commands in the data stream - including graphics and 2D barcodes.
	<p>This menu screen is only available when Status 5 is selected for Bi-Com interface. Determines how the printer will react if the item number (ID Command) is set to be processed by the printer.</p> <ul style="list-style-type: none"> • Disable - factory default. Does nothing regardless of whether the item number is included in the format. • Cancel - errors when the incorrect item number is being accessed. When the printer is brought back online from the error, by pressing the Line key, the incorrect job is canceled. • Resume - errors when the incorrect item number is being accessed. When the printer is brought back online from the error, by pressing the Line key, the incorrect job is canceled.
	<p>Block-Check-Code Algorithm Check. Only available when Status 5 is selected for Bi-Com interface. Determines how the printer will react if the BCC is set to be processed by the printer.</p> <ul style="list-style-type: none"> • Disable - factory default. Does nothing regardless of whether the BCC is included in the format. • Cancel - errors when the incorrect BCC is being accessed. When the printer is brought back online from an error, by pressing the Line key, the incorrect job is printed. • Resume - errors when the incorrect item number is being accessed. When the printer is brought back online from the error, by pressing the Line key, the incorrect job is canceled.
	<p>The history buffer stores a history of printer statuses. Is only available when Status 5 is selected for Bi-Com interface.</p> <ul style="list-style-type: none"> • Temporary - factory default. Store the history buffer in the internal RAM. This memory is deleted when the printer's power is turned off. • Permanent - stores the history buffer in Flash (internal or optional) Memory. This memory can only be cleared through the printer's display.

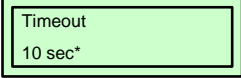
UNIVERSAL SERIAL BUS (USB) INTERFACE MODE (TABLE 4-7)	
MENU	DESCRIPTION
	<p>Communication Protocol. Selects the mode of Bi-Directional communications. In most cases this menu does not need to be altered and is meant to help support legacy applications which may have incorporated older bi-directional statuses. Anything other than Status 5 or Standard (none) is not recommended.</p> <ul style="list-style-type: none"> • Status 5 - factory default. Most advanced of the options. This status is the most recent and represented in the interface specifications. For more information, refer to the appropriate section in the programming and interface guide. • Standard - bi-directional interface is not used. • Status 2 - legacy bi-directional support. Not recommended for new applications. • Status 3 - legacy bi-directional support. Not recommended for new applications. • Status 4 - legacy bi-directional support. Not recommended for new applications.
	<p>Is the menu selection screen for the USB Port option of the INTERFACES mode.</p>
	<p>Is the main menu screen for the Host Interface option of the INTERFACES mode. There are only two options relative to the serial interface, ignore all others.</p> <ul style="list-style-type: none"> • Auto Switching - the printer automatically switches to the relative interface type and moves into the applicable menus. • USB - factory default. Allows the operator to select the interface and the relative menus will follow.
	<p>Is a transitional screen that will allow the buffer size to be established in the following screen.</p>
	<p>This menu configures the amount of memory allocated for the serial port buffer. The range is 1 to 16 Kbytes in 1 kbyte increments.</p> <p>Note: If a baud rate 19200 or greater is selected, the Buffer Size in K parameter may need to be increased from the default to 16 Kbytes to improve performance.</p> <p>The factory default is 16.</p>
	<p>This is the value used by the printer to time out from the current port and check the other selected Port Types for data print. When the printer has not received data from the host after a certain period of time, it must timeout in order to service other ports.</p> <p>The factory default of 10 seconds with an allowable range of 1 to 60 seconds.</p>

LOCAL AREA NETWORK (LAN) INTERFACE MODE (TABLE 4-8)	
MENU	DESCRIPTION
	<p>Permits entry into the INTERFACES Mode.</p>

LOCAL AREA NETWORK (LAN) INTERFACE MODE (TABLE 4-8)	
MENU	DESCRIPTION
<div style="border: 1px solid black; padding: 5px;"> INTERFACES Ignore CR/LF Item No. Check BCC Check History Buffer Comm. Protocol Host Interface ETHERNET PORT ETHERNET ADDRESS ETHERNET SETTING Parallel Port USB Port Serial Port Printer Mgt </div>	Is the menu selection screen for the INTERFACES Mode.
<div style="border: 1px solid black; padding: 5px;"> Ignore CR/LF No* </div>	Determines whether the print data code will be deleted. Hexadecimal graphic data will not be deleted. <ul style="list-style-type: none"> • No - factory default. Will not be deleted. • Yes - will delete all carriage returns (CR) and line feed (LF) commands in the data stream - including graphics and 2D barcodes.
<div style="border: 1px solid black; padding: 5px;"> Item No. Check Disable* </div>	This menu screen is only available when Status 5 is selected for Bi-Com interface. Determines how the printer will react if the item number (ID Command) is set to be processed by the printer. <ul style="list-style-type: none"> • Disable - factory default. Does nothing regardless of whether the item number is included in the format. • Cancel - errors when the incorrect item number is being accessed. When the printer is brought back online from the error, by pressing the Line key, the incorrect job is canceled. • Resume - errors when the incorrect item number is being accessed. When the printer is brought back online from the error, by pressing the Line key, the incorrect job is canceled.
<div style="border: 1px solid black; padding: 5px;"> BCC Check Disable* </div>	Block-Check-Code Algorithm Check. Only available when Status 5 is selected for Bi-Com interface. Determines how the printer will react if the BCC is set to be processed by the printer. <ul style="list-style-type: none"> • Disable - factory default. Does nothing regardless of whether the BCC is included in the format. • Cancel - errors when the incorrect BCC is being accessed. When the printer is brought back online from an error, by pressing the Line key, the incorrect job is printed. • Resume - errors when the incorrect item number is being accessed. When the printer is brought back online from the error, by pressing the Line key, the incorrect job is canceled.
<div style="border: 1px solid black; padding: 5px;"> History Buffer Temporary* </div>	The history buffer stores a history of printer statuses. Is only available when Status 5 is selected for Bi-Com interface. <ul style="list-style-type: none"> • Temporary - factory default. Store the history buffer in the internal RAM. This memory is deleted when the printer's power is turned off. • Permanent - stores the history buffer in Flash (internal or optional) Memory. This memory can only be cleared through the printer's display.

LOCAL AREA NETWORK (LAN) INTERFACE MODE (TABLE 4-8)	
MENU	DESCRIPTION
<div style="border: 1px solid black; padding: 2px; width: fit-content;">Comm. Protocol Status 5*</div>	<p>Communication Protocol. Selects the mode of Bi-Directional communications. In most cases this menu does not need to be altered and is meant to help support legacy applications which may have incorporated older bi-directional statuses. Anythin other than Staus 5 or Standard (none) is not recommended.</p> <ul style="list-style-type: none"> • Status 5 - factory default. Most advanced of the options. This status is the most recent and represented in the interface specifications. For more information, refer to the appropriate section in the programming and interface guide. • Standard - bi-directional interface is not used. • Status 2 - legacy bi-directional support. Not recommended for new applications. • Status 3 - legacy bi-directional support. Not recommended for new applications. • Status 4 - legacy bi-directional support. Not recommended for new applications.
<div style="border: 1px solid black; padding: 2px; width: fit-content;">INTERFACES Host Interface*</div>	<p>Is the menu selection screen for the Host Interface option of the INTERFACES mode.</p>
<div style="border: 1px solid black; padding: 2px; width: fit-content;">Host Interface Auto Switching*</div>	<p>There are only two options relative to the serial interface, ignore all others.</p> <ul style="list-style-type: none"> • Auto Switching - the printer automatically switches to the relative interface type and moves into the applicable menus. • Ethernet - factory default. Allows the operator to select the interface and the relative menus will follow.
<div style="border: 1px solid black; padding: 2px; width: fit-content;">INTERFACES ETHERNET PORT</div>	<p>Is the menu selection screen for the Ethernet Port option of the INTERFACES mode.</p>
<div style="border: 1px solid black; padding: 2px; width: fit-content;">ETHERNET PORT Timeout</div>	<p>Is a menu subset of the Ethernet Port option. Will move into the Timeout menu.</p>
<div style="border: 1px solid black; padding: 2px; width: fit-content;">Timeout 10 sec*</div>	<p>This is the value used by the printer to time out from the current port and check the other selected Port Types for data print. When the printer has not received data from the host after a certain period of time, it must timeout in order to service other ports.</p> <p>The factory default of 10 seconds with an allowable range of 1 to 60 seconds.</p>
<div style="border: 1px solid black; padding: 2px; width: fit-content;">Switch Out On Data Timeout*</div>	<p>Determines when other ports are active and able to communicate with the printer when the Ethernet interface is not in use.</p> <ul style="list-style-type: none"> • Data Timeout - factory default. The other ports (Parallel, Serial, USB) are able to send data to the printer when the timeout setting has been reached. This setting is adjustable via the display menu item Timeout. • Session Close - the other ports (Parallel, Serial, USB) are able to send data to the printer when the port has been closed. Example: If a RAW port of 9100 is open, the printer will not accept data from another interface until that port is closed by the host.
<div style="border: 1px solid black; padding: 2px; width: fit-content;">INTERFACES ETHERNET SETTING</div>	<p>Is the menu selection screen for the Ethernet Setting option of the INTERFACES mode.</p>

LOCAL AREA NETWORK (LAN) INTERFACE MODE (TABLE 4-8)	
MENU	DESCRIPTION
<div style="border: 1px solid black; padding: 5px;"> ETHERNET SETTING NetBIOS Protocol </div>	Is a transitional screen that allows entry into the Net BIOS Protocol menu.
<div style="border: 1px solid black; padding: 5px;"> NetBIOS Protocol Enable* </div>	Allows determination of if the NIC will recognize the NetBIOS protocol. <ul style="list-style-type: none"> • Enable - factory default. Will recognize. • Disable - will not recognize.
<div style="border: 1px solid black; padding: 5px;"> ASCII Data Port 1024* </div>	This options allows for the port number to be set for ASCII print jobs. The data port number must match the host computer setting. The allowable range is 0 to 65535 , and the factory default is 9100 .
<div style="border: 1px solid black; padding: 5px;"> Keep Alive Timer 3 minutes* </div>	Determines the amount of time that the tcp connection will remain connected after the print job has terminated. The allowable range is 2 to 10 minutes , and the factory default is 3 minutes .
<div style="border: 1px solid black; padding: 5px;"> Ethernet Speed Auto Select* </div>	This menu appears only if a 10/100Base-t Network Interface Card (NIC) is installed. There are five different speed modes to allow compatibility with different systems and networks. <ul style="list-style-type: none"> • Auto Select - factory default. Tells the 10/100Base-T NIC to perform an automatic detection scheme and configure itself to be one of the other allowable options. • 10 Half Duplex - communicates at 10 megabytes per second using half duplex. • 10 Full Duplex - communicates at 10 megabytes per second using full duplex. • 100 Half Duplex - communicates at 100 megabytes per second using half duplex. • 100 Full Duplex - communicates at 100 megabytes per second using full duplex.
<div style="border: 1px solid black; padding: 5px;"> Job Control Standard* </div>	Determines how the printer and/or NIC card respond when a job has been completed. The definition of a complete job is also determined by this setting. <ul style="list-style-type: none"> • Standard - factory default. The NIC card responds to the host that the job is complete when the entire print job has been accepted by the printer. • Enhanced - the NIC card responds to the host that the job is complete when the entire job has not only been accepted by the printer, but also completely printed. • Off - without synchronization between the NIC and the printer. The NIC card is simply a pass-through and the printer tells the host when the job is complete.
<div style="border: 1px solid black; padding: 5px;"> Offline Process Disable* </div>	Determines whether the printer processes incoming data when it is in an offline state. <ul style="list-style-type: none"> • Disable - factory default. The printer does not process data while offline. • Enable - continues to process (but not print) the current network/parallel job while the printer is offline until in a buffer-near-full state.
<div style="border: 1px solid black; padding: 5px;"> ETHERNET ADDRESS IP Address Subnet Mask Gateway Address MAC Address DHCP </div>	Is the menu selection screen for the Ethernet Address option of the INTERFACES mode. Its menu options are explained in the following five menu screen descriptions.

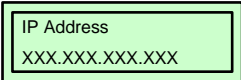
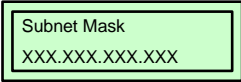
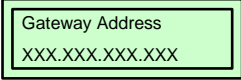
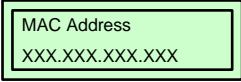
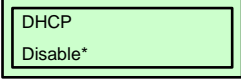
LOCAL AREA NETWORK (LAN) INTERFACE MODE (TABLE 4-8)	
MENU	DESCRIPTION
	<p>This menu allows the IP Address to be set for the TCP/IP protocol in four three-digit segments (SEG1 through SEG4). If the IP Address is assigned by Bootp, ARP, or DHCP it is dynamic and read only.</p> <p>The factory defaults for SEG1 through SEG4 are 000, 000, 000, and 000.</p> <p>Note: When changing the IP Address, the printer resets the Network Interface Card (NIC) when the printer is placed online. When the printer resets the NIC, the LCD displays DO NOT POWER OFF. After the NIC has completed initialization, the LCD displays E-NET INIT to signal that the NIC and printer are in initialization process. When both the NIC and printer have completed the initialization, the LCD displays E-NET READY.</p>
	<p>Allows the Subnet Mask to be set for the TCP/IP protocol in four three-digit segments (SEG1 through SEG4). If the Subnet Mask is assigned by Bootp, Arp or DHCP, it is dynamic and read only.</p> <p>The defaults for the SEG1 through SEG4 are 000, 000, 000, and 000.</p> <p>Note: When changing the Subnet Mask, the printer resets the NIC when the printer is placed online. When the printer resets the NIC, the LCD displays DO NOT POWER OFF. After the NIC has completed its initialization, the LCD displays E-NET INIT to signal that the NIC and printer are in the initialization process. When both the NIC and printer have completed initialization, the LCD displays E-NET READY.</p>
	<p>Allows the Gateway Address to be set for the TCP/IP protocol in four three-digit segments (SEG1 through SEG4). If the Gateway Address is assigned by Bootp, ARP, or DHCP, it is dynamic and read only.</p> <p>The defaults for the SEG1 through SEG4 are 000, 000, 000, and 000.</p> <p>Note: When changing the Gateway Address, the printer resets the NIC when the printer is placed online. When the printer resets the NIC, the LCD displays DO NOT POWER OFF. After the NIC has completed its initialization, the LCD displays E-NET INIT to signal that the NIC and printer are in the initialization process. When both the NIC and printer have completed initialization, the LCD displays E-NET READY.</p>
	<p>This is an informational screen that displays the manufacturer's assigned number. This number is unique for each NIC.</p>
	<p>Allows the DHCP protocol to be enabled or disabled through this menu.</p> <p>The factory default is Disable.</p> <p>Note: Consult with your systems administrator for the appropriate setting.</p>

WIRELESS LOCAL AREA NETWORK (WLAN) INTERFACE MODE (TABLE 4-9)	
MENU	DESCRIPTION
	<p>Permits entry into the INTERFACES Mode.</p>



WIRELESS LOCAL AREA NETWORK (WLAN) INTERFACE MODE (TABLE 4-9)	
MENU	DESCRIPTION
<div style="border: 1px solid black; padding: 5px;"> INTERFACES Ignore CR/LF Item No. Check BCC Check History Buffer Comm. Protocol Host Interface ETHERNET PORT ETHERNET SETTING WLAN ADDRESS WLAN SETTING Parallel Port USB Port Serial Port Printer Mgt </div>	Is the menu selection screen for the INTERFACES Mode.
<div style="border: 1px solid black; padding: 5px;"> Ignore CR/LF No* </div>	Determines whether the print data code will be deleted. Hexadecimal graphic data will not be deleted. <ul style="list-style-type: none"> • No - factory default. Will not be deleted. • Yes - will delete all carriage returns (CR) and line feed (LF) commands in the data stream - including graphics and 2D barcodes.
<div style="border: 1px solid black; padding: 5px;"> Item No. Check Disable* </div>	This menu screen is only available when Status 5 is selected for Bi-Com interface. Determines how the printer will react if the item number (ID Command) is set to be processed by the printer. <ul style="list-style-type: none"> • Disable - factory default. Does nothing regardless of whether the item number is included in the format. • Cancel - errors when the incorrect item number is being accessed. When the printer is brought back online from the error, by pressing the Line key, the incorrect job is canceled. • Resume - errors when the incorrect item number is being accessed. When the printer is brought back online from the error, by pressing the Line key, the incorrect job is canceled.
<div style="border: 1px solid black; padding: 5px;"> BCC Check Disable* </div>	Block-Check-Code Algorithm Check. Only available when Status 5 is selected for Bi-Com interface. Determines how the printer will react if the BCC is set to be processed by the printer. <ul style="list-style-type: none"> • Disable - factory default. Does nothing regardless of whether the BCC is included in the format. • Cancel - errors when the incorrect BCC is being accessed. When the printer is brought back online from an error, by pressing the Line key, the incorrect job is printed. • Resume - errors when the incorrect item number is being accessed. When the printer is brought back online from the error, by pressing the Line key, the incorrect job is canceled.
<div style="border: 1px solid black; padding: 5px;"> History Buffer Temporary* </div>	The history buffer stores a history of printer statuses. Is only available when Status 5 is selected for Bi-Com interface. <ul style="list-style-type: none"> • Temporary - factory default. Store the history buffer in the internal RAM. This memory is deleted when the printer's power is turned off. • Permanent - stores the history buffer in Flash (internal or optional) Memory. This memory can only be cleared through the printer's display.

WIRELESS LOCAL AREA NETWORK (WLAN) INTERFACE MODE (TABLE 4-9)	
MENU	DESCRIPTION
Comm. Protocol Status 5*	<p>Communication Protocol. Selects the mode of Bi-Directional communications. In most cases this menu does not need to be altered and is meant to help support legacy applications which may have incorporated older bi-directional statuses. Anything other than Status 5 or Standard (none) is not recommended.</p> <ul style="list-style-type: none"> • Status 5 - factory default. Most advanced of the options. This status is the most recent and represented in the interface specifications. For more information, refer to the appropriate section in the programming and interface guide. • Standard - bi-directional interface is not used. • Status 2 - legacy bi-directional support. Not recommended for new applications. • Status 3 - legacy bi-directional support. Not recommended for new applications. • Status 4 - legacy bi-directional support. Not recommended for new applications.
Host Interface Ethernet*	<p>There are only two options relative to the serial interface, ignore all others.</p> <ul style="list-style-type: none"> • Auto Switching - the printer automatically switches to the relative interface type and moves into the applicable menus. • Ethernet - factory default. Allows the operator to select the interface and the relative menus will follow.
ETHERNET SETTING NetBIOS Protocol	<p>Is a transitional screen that allows entry into the Net BIOS Protocol menu.</p>
NetBIOS Protocol Enable*	<p>Allows determination of if the NIC will recognize the NetBIOS protocol.</p> <ul style="list-style-type: none"> • Enable - factory default. Will recognize. • Disable - will not recognize.
ASCII Data Port 1024*	<p>This options allows for the port number to be set for ASCII print jobs. The data port number must match the host computer setting.</p> <p>The allowable range is 0 to 65535, and the factory default is 9100.</p>
Keep Alive Timer 3 minutes*	<p>Determines the amount of time that the tcp connection will remain connected after the print job has terminated.</p> <p>The allowable range is 2 to 10 minutes, and the factory default is 3 minutes.</p>
Ethernet Speed Auto Select*	<p>This menu appears only if a 10/100Base-t Network Interface Card (NIC) is installed. There are five different speed modes to allow compatibility with different systems and networks.</p> <ul style="list-style-type: none"> • Auto Select - factory default. Tells the 10/100Base-T NIC to perform an automatic detection scheme and configure itself to be one of the other allowable options. • 10 Half Duplex - communicates at 10 megabytes per second using half duplex. • 10 Full Duplex - communicates at 10 megabytes per second using full duplex. • 100 Half Duplex - communicates at 100 megabytes per second using half duplex. • 100 Full Duplex - communicates at 100 megabytes per second using full duplex.

WIRELESS LOCAL AREA NETWORK (WLAN) INTERFACE MODE (TABLE 4-9)	
MENU	DESCRIPTION
<div style="border: 1px solid black; padding: 5px; width: fit-content;"> Job Control Standard* </div>	<p>Determines how the printer and/or NIC card respond when a job has been completed. The definition of a complete job is also determined by this setting.</p> <ul style="list-style-type: none"> • Standard - factory default. The NIC card responds to the host that the job is complete when the entire print job has been accepted by the printer. • Enhanced - the NIC card responds to the host that the job is complete when the entire job has not only been accepted by the printer, but also completely printed. • Off - without synchronization between the NIC and the printer. The NIC card is simply a pass-through and the printer tells the host when the job is complete.
<div style="border: 1px solid black; padding: 5px; width: fit-content;"> Offline Process Disable* </div>	<p>Determines whether the printer processes incoming data when it is in an offline state.</p> <ul style="list-style-type: none"> • Disable - factory default. The printer does not process data while offline. • Enable - continues to process (but not print) the current network/parallel job while the printer is offline until in a buffer-near-full state.
<div style="border: 1px solid black; padding: 5px; width: fit-content;"> ETHERNET PORT Timeout </div>	<p>Is a menu subset of the Ethernet Port option. Will move into the Timeout menu.</p>
<div style="border: 1px solid black; padding: 5px; width: fit-content;"> Timeout 10 sec* </div>	<p>This is the value used by the printer to time out from the current port and check the other selected Port Types for data print. When the printer has not received data from the host after a certain period of time, it must timeout in order to service other ports.</p> <p>The factory default of 10 seconds with an allowable range of 1 to 60 seconds.</p>
<div style="border: 1px solid black; padding: 5px; width: fit-content;"> Switch Out On Data Timeout* </div>	<p>Determines when other ports are active and able to communicate with the printer when the Ethernet interface is not in use.</p> <ul style="list-style-type: none"> • Data Timeout - factory default. The other ports (Parallel, Serial, USB) are able to send data to the printer when the timeout setting has been reached. This setting is adjustable via the display menu item Timeout. • Session Close - the other ports (Parallel, Serial, USB) are able to send data to the printer when the port has been closed. Example: If a RAW port of 9100 is open, the printer will not accept data from another interface until that port is closed by the host.
<div style="border: 1px solid black; padding: 5px; width: fit-content;"> WLAN ADDRESS IP Address Subnet Mask Gateway Address MAC Address DHCP </div>	<p>Is a subset of menus of the INTERFACES mode. Additional menus may be selected from here.</p>
<div style="border: 1px solid black; padding: 5px; width: fit-content;"> IP Address XXX.XXX.XXX.XXX </div>	<p>This menu allows the IP Address for the TCP/IP protocol to be set in four three-digit segments (SEG1 through SEG4). If the IP Address is assigned by Bootp, ARP, or DHCP, it is dynamic and read only.</p> <p>When changing the IP Address, the printer resets the Network Interface Card (NIC) when the printer is placed online. When the printer resets the NIC, the LCD displays "DO NOT POWER OFF". After initialization is complete, the LCD displays "E-NET INIT" to signal that the NIC and printer are in the initialization process. When both the NIC and printer have completed initialization, the LCD displays "E-NET READY".</p> <p>The factory default is 000.000.000.000 .</p>

WIRELESS LOCAL AREA NETWORK (WLAN) INTERFACE MODE (TABLE 4-9)	
MENU	DESCRIPTION
<div style="border: 1px solid black; padding: 5px;"> Subnet Mask XXX.XXX.XXX.XXX </div>	<p>This menu allows the Subnet Mask for the TCP/IP protocol to be set in four three-digit segments (SEG1 through SEG4). If the Subnet Mask is assigned by Bootp, ARP, or DHCP, it is dynamic and read only.</p> <p>When changing the Subnet Mask, the printer resets the Network Interface Card (NIC) when the printer is placed online. When the printer resets the NIC, the LCD displays "DO NOT POWER OFF". After initialization is complete, the LCD displays "E-NET INIT" to signal that the NIC and printer are in the initialization process. When both the NIC and printer have completed initialization, the LCD displays "E-NET READY".</p> <p>The factory default is 000.000.000.000 .</p>
<div style="border: 1px solid black; padding: 5px;"> Gateway Address XXX.XXX.XXX.XXX </div>	<p>This menu allows the Gateway Address for the TCP/IP protocol to be set in four three-digit segments (SEG1 through SEG4). If the Subnet Mask is assigned by Bootp, ARP, or DHCP, it is dynamic and read only.</p> <p>When changing the Gateway Address, the printer resets the Network Interface Card (NIC) when the printer is placed online. When the printer resets the NIC, the LCD displays "DO NOT POWER OFF". After initialization is complete, the LCD displays "E-NET INIT" to signal that the NIC and printer are in the initialization process. When both the NIC and printer have completed initialization, the LCD displays "E-NET READY".</p> <p>The factory default is 000.000.000.000 .</p>
<div style="border: 1px solid black; padding: 5px;"> MAC Address XXX.XXX.XXX.XXX </div>	<p>This is an informational screen that displays the manufacturer's assigned number. This number is unique for each NIC.</p>
<div style="border: 1px solid black; padding: 5px;"> DHCP Disable* </div>	<p>Allows the DHCP protocol to be enabled or disabled through this menu.</p> <p>The factory default is Disable.</p> <p>Note: Consult with your systems administrator for the appropriate setting.</p>
<div style="border: 1px solid black; padding: 5px;"> WLAN SETTING Signal Strength Operation Mode SSID Name Reset SSID Name Min Xfer Rate Channel Ant. Diversity Preamble Power Mgt Transmit Power Internat. Mode Auth Method Reset WEP Keys WEP Key 1 WEP Key 2 WEP Key 3 WEP Key 4 Default WEP Key </div>	<p>Is a subset of menus of the INTERFACES mode. Additional menus may be selected form here.</p>
<div style="border: 1px solid black; padding: 5px;"> Signal Strength 255%* </div>	<p>This is an informational screen that displays the factory set signal strength of the wireles interface and cannot be changed.</p>

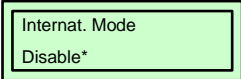
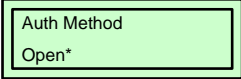
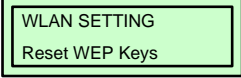
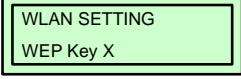
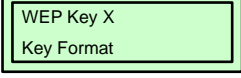
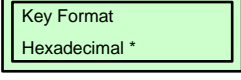
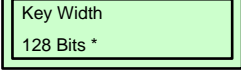
WIRELESS LOCAL AREA NETWORK (WLAN) INTERFACE MODE (TABLE 4-9)	
MENU	DESCRIPTION
<div style="border: 1px solid black; padding: 5px;"> SSID Name SSID Name (01 – 15) SSID Name (16 – 30) SSID Name (31 – 32) </div>	<p>A 1 to 32 character, case-sensitive string that identifies the Extended Service Set Identification (ESS_ID) network with which the unit is affiliated. ESS_ID is also referred to as NET_ID.</p> <p>This character string is broken up into three sets. This menu allows a psecific set to be selected and the identification entered into the menu screen that follows.</p>
<div style="border: 1px solid black; padding: 5px;"> SSID Name XX - XX * </div>	<p>These characters may be alphanumeric, symbols, or spaces.</p>
<div style="border: 1px solid black; padding: 5px;"> WLAN SETTING Reset SSID Name </div>	<p>This menu allows the determination of if the SSID Name is too be reset.</p>
<div style="border: 1px solid black; padding: 5px;"> Min Xfer Rate Auto-negociable* </div>	<p>Minimum Tranfer Rate. Allows the minimum speed at which the wireless option will accept a connection to be set in millions of bits per second.</p> <ul style="list-style-type: none"> • Auto-negociate - factory default. Automatically selects. • 1Mb/sec. - 1 million bits per second. • 2Mb/sec. - 2 million bits per second. • 5.5Mb/sec. - 5.5 million bits per second.
<div style="border: 1px solid black; padding: 5px;"> Channel Default* </div>	<p>Allows the wireless channel to be selected for the device to communicate.</p> <ul style="list-style-type: none"> • Default - factory default. the interface card detects the correct channel to communicate with the Access Point in infrastructure mode. • Select Channel - the allowable range is 1 to 15.
<div style="border: 1px solid black; padding: 5px;"> Ant. Diversity Diverse* </div>	<p>Antenna Diversity. Allows the type of antenna to be used to be selected.</p> <ul style="list-style-type: none"> • Diverse - factory default. Select to use the antenna with the best reception. • Primary - select to use the primary antenna on the server. • Auxiliary - select to use the auxiliary antenna on the server.
<div style="border: 1px solid black; padding: 5px;"> Preamble Default* </div>	<p>Allows the preamble length in tranfer packets to be selected. Preamble is the delay needed between packets of data. The preamble selection is dependent on the network.</p> <ul style="list-style-type: none"> • Default - factory default. The wireless option automatically determines the length. • Short - preamble of 96 microseconds. This is appropriate for most newer networks. • Long - preamble of 192 microseconds. This is for legacy systems that do not support the higher preamble rates.
<div style="border: 1px solid black; padding: 5px;"> Power Mgt 0 ms. * </div>	<p>Power Management. This menu allows the power-save and sleep modes to be set. The value set wil be in milliseconds. If set to zero, the power-save mode will be disabled.</p> <p>The allowable range is 0 to 1000 ms., and the factory default is 0 ms..</p>
<div style="border: 1px solid black; padding: 5px;"> Transit Power 100% * </div>	<p>Allows the transmission power to be set as a percentage of full power capabilities.</p> <p>The allowable range is 0 to 100%, and the factory default is 100%.</p>

WIRELESS LOCAL AREA NETWORK (WLAN) INTERFACE MODE (TABLE 4-9)	
MENU	DESCRIPTION
	<p>International Mode. Allows the determination of whether the wireless option adapts to international frequency requirements in Europe.</p> <ul style="list-style-type: none"> • Disable - factory default. Conforms to European standards. • Enable - does not conform to European standards.
	<p>Authentication Method. Allows the authentication method used for the wireless network interface to be selected.</p> <ul style="list-style-type: none"> • Open - factory default. Provides open authentication. • Shared - provides shared key authentication.
	<p>Allows all four WEP keys to be simultaneously reset.</p>
	<p>Allows which WEP Key will be formatted in the following menus.</p>
	<p>Is a transitional menu screen that will lead to menu screens that will allow the WEP Key to be formatted.</p>
	<p>Allows WEP Key input format to be selected.</p> <ul style="list-style-type: none"> • Hexadecimal - factory default. Valid characters are 0 to 9 and A to F (upper case only) with a maximum of 32 characters. • ASCII - allows for alphanumeric characters to be used with a maximum of 16 characters.
	<p>Allows the operator to select the width of the key desired.</p> <ul style="list-style-type: none"> • 128 Bits - factory default. 32 Hex values or 16 ASCII characters. • 40 Bits - 10 Hex values or 5 ASCII characters.
	<p>Enables the encryption (scramble) of information for security purposes. Up to four encryption keys may be set in either ASCII or hexadecimal format, and in either 40 or 128 bits. The mode bits chosen, the greater the difficulty of decoding the information.</p> <p>Note: None of the WEP Key Configuration menus display on the configuration printout.</p>

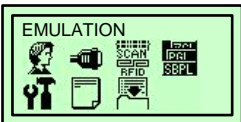
PGL EMULATION MODE (TABLE 4-10)	
MENU	DESCRIPTION
	<p>Permits entry into the EMULATION Mode.</p>

Unit 4: Printer Configuration

PGL EMULATION MODE (TABLE 4-10)	
MENU	DESCRIPTION
<div style="border: 1px solid black; padding: 5px; width: fit-content;"> EMULATION Select </div>	Allows the specific emulation to be selected or if the Select option is chosen, the menu to follow will contain a list of emulation options available.
<div style="border: 1px solid black; padding: 5px; width: fit-content;"> Select PGL* </div>	Allows the selection of the specific emulation to be selected from a list. The allowable emulation options are: PGL for Printronics, ZGL for Zebra, TGL for TEC, IGL for Intermecc, SGPL for SATO, and DGL for Datamax.
<div style="border: 1px solid black; padding: 5px;"> PGL Setup Character Group Standard Sets Select LP1 Define CR Code Define LF Code Autowrap Auto Uppercase Slash 0 Select SFCC Host Form Length Var Form Adjust Var Form Type Optimized Ratio PI Slew Range CR Edit Skip Cmd Prefix Ignore Text Power on IGP/PGL Ext Execute Copy AI 00 Spaces Select SO Char Ignore Mode Select Char Do FF at TOF Expanded Font Scalable Size Forms Handling PGL Normal UPC Descenders I-2/5 Selection C39 Compatibl. User-Def Ratio Lead PDF Dist Trunc Dyn Data Vertical Adjust Error Report Boundary Check Repeat Form Opt Preparser Cmd Preparser Port Storage Select </div>	Is the menu selection screen for the EMULATION Mode.
<div style="border: 1px solid black; padding: 5px; width: fit-content;"> Character Group Standard Sets* </div>	This menu selects the character set used by the printer.

PGL EMULATION MODE (TABLE 4-10)	
MENU	DESCRIPTION
<div style="border: 1px solid black; padding: 2px; width: fit-content;"> Standard Sets 0) ASCII* </div>	Provides access to the desired character set.
<div style="border: 1px solid black; padding: 2px; width: fit-content;"> Select LPI 6* </div>	<p>Lines Per Inch. This menu allows the quantity of lines that will be printed in a linear inch to be selected. Example: at 6 LPI, there is 1/6 inches from the top of one line to the top of the next.</p> <p>The allowable options are 6.0, 8.0, and 10.3 LPI. The factory default is 6.0 LPI.</p>
<div style="border: 1px solid black; padding: 2px; width: fit-content;"> Define CR Code CR= CR* </div>	<p>This menu controls the action of the printer when it receives a Carriage Return code (0D Hex) from the host computer. If this feature is enabled, each time the printer receives a carriage return, it inserts an additional Line Feed code (0A Hex) into the data stream. Do not use this feature if the host computer sends line feeds to the printer.</p> <ul style="list-style-type: none"> • CR = CR - factory default. Does not insert an extra line feed after each carriage return. • CR = CR + LF - inserts an extra line feed after each carriage return. The next print position will be print position 1 of the next line. <p>Note: For this menu to take effect in PGL, PGL Normal must be set to PGL Menu.</p>
<div style="border: 1px solid black; padding: 2px; width: fit-content;"> Define LF Code LF= LF* </div>	<p>This parameter forces the printer to insert an automatic Carriage Return code into the data stream whenever a Line Feed code occurs. This can be used in most installations, but is required if the host computer does not send carriage returns to the printer.</p> <ul style="list-style-type: none"> • LF = LF - factory default. Does not perform an automatic carriage return. The next print position will be at the current print character position on the next line. • LF = CR + LF - performs an automatic carriage return. The next print position will be print position 1 of the next line. <p>Note: For this menu to take effect in PGL, PGL Normal must be set to PGL Menu.</p>
<div style="border: 1px solid black; padding: 2px; width: fit-content;"> Autowrap Disable* </div>	<p>This parameter determines if text will wrap to the next line when the line of text exceeds the right margin.</p> <ul style="list-style-type: none"> • Disable - factory default. Truncates the text beyond the right margin until a CR or CR + LF is received. • Enable - automatically inserts a CR + LF after a full print line.
<div style="border: 1px solid black; padding: 2px; width: fit-content;"> Auto Uppercase Disable* </div>	<p>This parameter enables the printer to print text in all uppercase when using the ALPHA command.</p> <ul style="list-style-type: none"> • Disable - factory default. Will print in upper and lowercase. • Enable - will print text only in uppercase.
<div style="border: 1px solid black; padding: 2px; width: fit-content;"> Slash 0 Disable* </div>	<p>This parameter allows printing the zero numeral with or without a diagonal slash through it. This option applies to all character sets except OCR-A and OCR-B.</p> <ul style="list-style-type: none"> • Disable - factory default. Zero will be printed without a slash. • Enable - zero will be printed with a slash.
<div style="border: 1px solid black; padding: 2px; width: fit-content;"> Select SFCC 126* </div>	<p>Specifies which decimal code will be used as the Special Function Control Code (SFCC). The SFCC denotes the following data is a PGL command.</p> <p>The allowable range is 1 to 255, and the factory default is 126.</p>

PGL EMULATION MODE (TABLE 4-10)	
MENU	DESCRIPTION
<div style="border: 1px solid black; padding: 5px; width: fit-content;"> Host Form Length Enable* </div>	Determines how the physical label length is affected upon receiving an EXECUTE command. <ul style="list-style-type: none"> • Enable - factory default. The physical label length will change to match the form length specified in CREATE command. The physical label size remains at the new setting until another EXECUTE command is received or the printer setup menu settings are changed. • Var. Length - the physical label length is the longest print element plus the setting of Var Form Adjust. • Var Dynamic Len - the physical label length will change to the longest print element defined in CREATE command plus the Var Form Adjust menu. • Disable - forms printed with EXECUTE command do not change the physical label size. Therefore, the size of the form must fit within the current label dimensions or errors may occur.
<div style="border: 1px solid black; padding: 5px; width: fit-content;"> Var Form Adjust 00.0 inches* </div>	This menu specifies an amount in tenth of inches, to add to the length of variable-length forms. Variable length forms use a semi-colon at the end of the Create command: ~CREATE; <FORMNAME>:0.
<div style="border: 1px solid black; padding: 5px; width: fit-content;"> Var Form Type Add Nothing* </div>	Determines the manner that form length is set. The physical form length can be set by command or by selecting the final print position on a form. <ul style="list-style-type: none"> • Add Nothing - factory default. No action is taken. • Add; 0 - the form length ends at the longest printed element. The same as: ~CREATE;filename;0. • Add; X - the form length is the same as the physical page length (the Label Length menu under MEDIA SETUP). The same as: ~CREATE;filename;X.
<div style="border: 1px solid black; padding: 5px; width: fit-content;"> Optimized Ratio Disable* </div>	This option selects bar code ratios for certain bar codes including Code 39 and Interleaved 2 of 5. It is included for compatibility with the IGP-X00 printers. <ul style="list-style-type: none"> • Disable - factory default. Use standard barcode ratios. • Enable - select the alternative barcode ratios.
<div style="border: 1px solid black; padding: 5px; width: fit-content;"> PI Slew Range 16* </div>	Allows for specification of the quantity of lines the backing paper will feed. <ul style="list-style-type: none"> • 16 - factory default. A paper slew of 0 to 15 will move 1 to 16 lines. • 15 - a paper slew of 1 to 15 will move 1 to 15 lines. A paper slew of 0 will move 1 line.
<div style="border: 1px solid black; padding: 5px; width: fit-content;"> CR Edit Disable* </div>	This parameter determines if a carriage return will be followed by a line feed. <ul style="list-style-type: none"> • Disable - factory default. Carriage returns not followed by line feeds are ignored. • Enable - processes all carriage returns including those not followed by line feeds.
<div style="border: 1px solid black; padding: 5px; width: fit-content;"> Skip Cmd Prefix Enable* </div>	Skip Command Prefix. This parameter determines if the printer will print any data before a PGL command is received. <ul style="list-style-type: none"> • Enable - factory default. Will print. • Disable - will not print.
<div style="border: 1px solid black; padding: 5px; width: fit-content;"> Ignore Text Disable* </div>	Allows selection of whether the printer will ignore unformatted text. Example: With a simple text field using a recognizable printer, the printer can either print this unformatted text or ignore it. <ul style="list-style-type: none"> • Disable - factory default. Text in normal mode will be printed. Attributes to be printed depend on the PGL Normal menu setting. • Enable - any line of text (non-PGL commands) in normal mode will be ignored.

PGL EMULATION MODE (TABLE 4-10)	
MENU	DESCRIPTION
<div style="border: 1px solid black; padding: 2px; width: fit-content; margin: auto;"> Power on IGP/PGL Enable* </div>	<p>Allows setting the IGP/PGL feature so that it is enabled or disabled when the printer is powered on.</p> <ul style="list-style-type: none"> • Enable - factory default. The IGP/PGL is enabled when the printer is powered on. The PGL feature is initialized in the Normal mode. • Disable - PGL is disabled when the printer is powered on. The PGL feature is initialized to the Quite mode.
<div style="border: 1px solid black; padding: 2px; width: fit-content; margin: auto;"> Ext Execute Copy Disable* </div>	<p>Ext Execute copy</p> <ul style="list-style-type: none"> • Disable - factory default. Dynamic data, overlay data, etc., are not allowed if the optional Form Count parameter (number of forms printed) is specified as part of the Execute command. This setting is IGP-100 compatible. • Enable - dynamic data, overlay data, etc., are allowed within a form where the Form Count parameter is specified in the Execute command. In this case, the same form is printed for whatever is the Form Count. Incremental data is not incremented since the printing page is the same. The overlay data is only printed with the first form and not on subsequent forms, and each form is printed on a separate page.
<div style="border: 1px solid black; padding: 2px; width: fit-content; margin: auto;"> AI 00 Spaces Disable* </div>	<p>This option is designated for EAN/UCC-128 barcodes whose application identifier (AI) is 00.</p> <ul style="list-style-type: none"> • Disable - factory default. The printable data field is printed with the AI enclosed in parenthesis. • Enable - the printable data field is printed with the UCC fields separated by spaces. This option is IGP-X00 compatible.
<div style="border: 1px solid black; padding: 2px; width: fit-content; margin: auto;"> Select SO Char 14* </div>	<p>Select Shift Out Character. Allows to specify a decimal code from 0 through 255 to be used in place of Shift Out as the control code which allows access for the alternate set of control function characters.</p> <p>The allowable range is 0 to 255, and the default is 14.</p>
<div style="border: 1px solid black; padding: 2px; width: fit-content; margin: auto;"> Ignore Mode Disable* </div>	<p>This parameter instructs the IGP to ignore the character selected under the Select Character menu.</p> <ul style="list-style-type: none"> • Disable - factory default. The IGP does not ignore any characters. • Enable - the IGP ignores the character specified in the Select Character menu.
<div style="border: 1px solid black; padding: 2px; width: fit-content; margin: auto;"> Select Char 0* </div>	<p>Select Character. This parameter selects which character to discard when Ignore mode is enabled.</p> <p>The allowable range is 0 to 255 (in decimal), and the default is 0.</p>
<div style="border: 1px solid black; padding: 2px; width: fit-content; margin: auto;"> Do FF at TOF Enable* </div>	<p>Determines whether the printer, with media already set at the top-of-form position, will advance media to the next top-of-form position upon receipt of an FF command.</p> <ul style="list-style-type: none"> • Enable - factory default. The printer will advance media from the present top-of-form position to the next top-of-form position upon receipt of an FF command. • Disable - The printer will not advance media from the present top-of-form position to the next top-of-form position upon receipt of an FF command.
<div style="border: 1px solid black; padding: 2px; width: fit-content; margin: auto;"> Expanded Font Scalable* </div>	<p>Allows printing of characters in different sizes with specified parameters and to select which font face to use.</p> <ul style="list-style-type: none"> • Scalable - factory default. Uses scalable fonts. • Block - uses block fonts. • Alt. Block 1 - uses alternative block fonts with a different character set.

PGL EMULATION MODE (TABLE 4-10)	
MENU	DESCRIPTION
<div style="border: 1px solid black; padding: 5px; width: fit-content;"> Scalable Size Normal* </div>	This option determines how scalable characters are sized. <ul style="list-style-type: none"> • Normal - factory default. Normal scaling. • Block - the scalable characters are made to be the same size as block characters in the old IGP-X00 printers.
<div style="border: 1px solid black; padding: 5px; width: fit-content;"> Forms Handling Disable* </div>	Determines the handling of form. <ul style="list-style-type: none"> • Disable - factory default. No effect. • Auto Eject - automatically ejects a page at the end of the job. • Auto TOF - automatically does a form feed (FF) at the end of each form to the next top-of-form.
<div style="border: 1px solid black; padding: 5px; width: fit-content;"> PGL Normal LP+ Menu* </div>	Determines whether PGL passes the text data in Normal mode or if PGL will print the text itself. <ul style="list-style-type: none"> • LP + Menu - factory default. PGL will pass the text data to LP+ only in the default setting state (6LPI, default character set, and font attribute). • PGL Menu - PGL will always print the text data itself.
<div style="border: 1px solid black; padding: 5px; width: fit-content;"> UPC Descenders Always* </div>	Allows printing barcode descenders when human-readable data is not presented in the UPC/EAN barcodes. <ul style="list-style-type: none"> • Always - factory default. UPC/EAN barcodes are printed with descenders, even where there is not human-readable data. • Never - UPC/EAN barcodes are printed without descenders if the PDF command is present. • Only With PDF - UPC/EAN barcodes are printed with descenders only when the PDF command is presented.
<div style="border: 1px solid black; padding: 5px; width: fit-content;"> I-2/5 Selection Loading Zero* </div>	Interleaved 2 of 5. Allows compatibility with special IGP-X00 customizations. Usually, these barcodes have an odd quantity of digits, a leading zero is inserted in front of the data. However, this special IGP-X00 customization provides the option of adding a space character at the end of the barcode instead. <ul style="list-style-type: none"> • Leading Zero - factory default. A leading zero is inserted in front of the data. • Trailing Space - a space is inserted at the end of the data instead of a leading zero. • X2 DPD - the barcode with a magnification of x2 will use the specially configured ratios 3:3:6:5 rather than 3:6:9:12 for compatibility issues. • Modulo 7 CD - the barcode uses a modulo 7 check digit instead of the default module 10 check digit.
<div style="border: 1px solid black; padding: 5px; width: fit-content;"> C39 Compatbl. Disable* </div>	Allows the prior method of decoding C39 alternative character set compatible with the new. <ul style="list-style-type: none"> • Enable - factory default. Matches the prior method. • Disable - uses the current method of decoding.
<div style="border: 1px solid black; padding: 5px; width: fit-content;"> User-Def Ratio Enable* </div>	Allows the user-defined barcode ratio to be ignored and to replace it with the default ratio (X1). <ul style="list-style-type: none"> • Enable - factory default. Allows the user-defined barcode ratio. • Disable - replaces the user-defined ratio.
<div style="border: 1px solid black; padding: 5px; width: fit-content;"> Lead PDF Dist 0.10 inches* </div>	Adjust the leading and trailing character distance of PDF for UPC/EAN barcodes. The allowable range is 0.01 to 0.10 inches in 0.01 increments. the factory default is 0.10 inches .

Unit 4: Printer Configuration

PGL EMULATION MODE (TABLE 4-10)	
MENU	DESCRIPTION
<div style="border: 1px solid black; padding: 5px; width: fit-content;"> Trunc Dyn Data Disable* </div>	Allows dynamic data to be truncated up to the maximum data length specified in Create mode. <ul style="list-style-type: none"> • Disable - factory default. If the dynamic data exceeds the maximum data length, an error will report. • Enable - if the dynamic data exceeds the maximum data length, the data truncates.
<div style="border: 1px solid black; padding: 5px; width: fit-content;"> Vertical Adjust 0 dots* </div>	Allows adjustment of the printer's dpi (dot per inch) to expand or shrink the vertical position of graphic elements and the height of the vertical line. The allowable range is -20 dots to +20 dots with respect to the current printer dpi. The factory default is 0 dots .
<div style="border: 1px solid black; padding: 5px; width: fit-content;"> Error Report On* </div>	Allows setting the error reporting capability of the printer for PGL forms. <ul style="list-style-type: none"> • On - factory default. Full error checking reported. Any element that falls off the current page is reported as an error. • Debug Mode - places the printer in debug mode whenever a form is defined in Create mode. Each line of the create form will be printed along with an error if one has occurred. • Fault - allows halting the printer if a PGL error occurs. The PGL error prints and the message IGP/PGL Error displays on the operator panel. The printer then goes offline. The error must be cleared before the printer can resume normal operation. • Off - error checking is not performed. Graphic elements such as alpha. line, barcodes, etc., will be clipped if they are beyond the page boundaries.
<div style="border: 1px solid black; padding: 5px; width: fit-content;"> Boundary Check Enable* </div>	Turns the page boundary check on or off for all print elements. <ul style="list-style-type: none"> • Enable - factory default. An out of bound error is reported if the print element is out of the page boundary. • Disable - an out of bound error is not reported. The out of bound print element prints over the page boundary.
<div style="border: 1px solid black; padding: 5px; width: fit-content;"> Repeat Form Opt Enable* </div>	Selects whether the printer analyzes like data strings or not for faster throughput. If the host forms are alike, with minimal variables changes, then enabling will increase performance. If not, then enabling will only slow the process down. <ul style="list-style-type: none"> • Enable - factory default. Increases the processing speed of repeated forms for PGL, thereby resulting in increased printer throughput. This option does not provide benefit for forms that are unrelated to one another and are to be disabled under those circumstances. • Disable - select when subsequent forms are unrelated to each other.
<div style="border: 1px solid black; padding: 5px; width: fit-content;"> Preparser Cmd Status* </div>	Allows selection of which preparser command to use. Once the command is selected, the command will be executed immediately when it is sent to the printer. <ul style="list-style-type: none"> • Status - factory default. Select (STCC) STATUS command. • Cancel - select (STCC) CANCEL command.
<div style="border: 1px solid black; padding: 5px; width: fit-content;"> Preparser Port Disable* </div>	Allows selection of which port to send the Preparser command to the printer. <ul style="list-style-type: none"> • Disable - factory default. Not using Preparser command. • Parallel - the parallel port (including attached ethernet card).
<div style="border: 1px solid black; padding: 5px; width: fit-content;"> Storage Select DISK= EMC* </div>	Allows the user to map the parameter DISK. <ul style="list-style-type: none"> • DISK = EFC - factory default. Expanded memory cartridge. • DISK = PCB Flash - flash board.

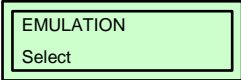
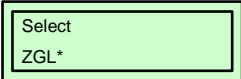
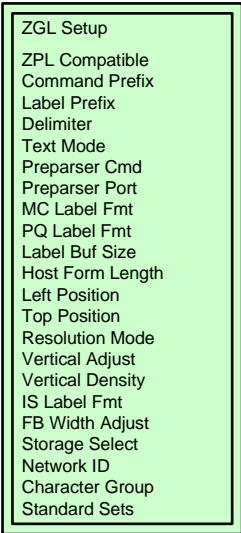
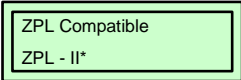
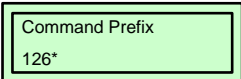
ZGL EMULATION MODE (TABLE 4-11)	
MENU	DESCRIPTION
	Permits entry into the EMULATION Mode.
	Allows the specific emulation to be selected or if the Select option is chosen, the menu to follow will contain a list of emulation options available.
	Allows the selection of the specific emulation to be selected from a list. The allowable emulation options are: PGL for Printronics, ZGL for Zebra, TGL for TEC, IGL for Intermec, SGPL for SATO, and DGL for Datamax.
	Is the menu selection screen for the EMULATION Mode.
	This menu allows compatibility selection to ZPL-I or ZPL-II. <ul style="list-style-type: none"> • ZPL-II - factory default. Zebra Programming Language II. • ZPL-I - Zebra Programming Language I.
	Allows selection of control instructions command prefix. The allowable range is 1 to 255 , and the factory default is 126 .

ZGL EMULATION MODE (TABLE 4-11)	
MENU	DESCRIPTION
<div style="border: 1px solid black; padding: 5px; width: fit-content;"> Label Prefix 94* </div>	Allows the format instructions command prefix to be selected. The allowable range is 1 to 255 , and the factory default is 94 .
<div style="border: 1px solid black; padding: 5px; width: fit-content;"> Delimiter 44* </div>	Allows the delimiter used to separate the parameter of a command to be selected. The allowable range is 1 to 255 , and the factory default is 44 .
<div style="border: 1px solid black; padding: 5px; width: fit-content;"> Text Mode Absorb* </div>	PPI supports text printing using the LP+ emulation. <ul style="list-style-type: none"> • Absorb - factory default. Use this setting for ZPL compatibility. Absorbs non-PPI data. • Auto Pass-thru - use this setting for text printing. Non-PPI data is passed to the LP+ emulation. • ZGL Quiet - all data and PPI commands are passed to the LP+ emulation.
<div style="border: 1px solid black; padding: 5px; width: fit-content;"> Preparser Cmd HS Command* </div>	The incoming data will be checked for the string HS or JA prior to entering the ZGL emulation parser based on the HS Command or the JA Command. Once the string is detected, the command will immediately take effect. The factory default is HS Command .
<div style="border: 1px solid black; padding: 5px; width: fit-content;"> Preparser Port Disable* </div>	Allows the selection of a port for preformatted data to be parsed through. The code being sent to the printer must comply to the parser format specified in the ZGL programming manual. <ul style="list-style-type: none"> • Disable - factory default. Disables the parser command feature. • Parallel - select if the data is coming to the parser through the parallel port. • Serial - select if the data is coming to the printer through the serial port.
<div style="border: 1px solid black; padding: 5px; width: fit-content;"> MC Label Fmt List Format* </div>	MC Label Format. The ^MC command determines whether the printed label image should be retained for use immediately following label definition. The MC Label Fmt option determines the internal format to be used for storing the label image (list format or bitmap format). <ul style="list-style-type: none"> • List Format - factory default. Works for most applications but memory must be sufficient. • Bitmap Format - to be used in applications where a large amount of data is sent. Bitmap format has greater efficiency of memory use. The label image of the next label is overlaid on the bitmap for the current label (instead of accumulating a list of stored print elements like List Format, which might eventually run out of memory in a large print job).
<div style="border: 1px solid black; padding: 5px; width: fit-content;"> PQ Label Fmt List Format* </div>	Print Quantity Label Format. Allows selection of the method for printing a label from memory. <ul style="list-style-type: none"> • List Format - factory default. A list of all stored print elements (graphics, text, barcodes) is reprocessed and executed again for each label. Work for most applications. • Bitmap Format - the bitmap of the first label is stored and copied over for each label printed without reprocessing a list of all print elements. To be used only in applications that print labels of the same data for greater print speed.
<div style="border: 1px solid black; padding: 5px; width: fit-content;"> Label But Size 560K Bytes* </div>	Label Buffer Size. This option allows the label buffer size to be set. The buffer is used to store the data from ^XA up to ^XZ for command processing. The maximum buffer size cannot exceed the amount of available memory in the system. If a menu value greater than the amount of memory available is selected, the menu value will be set to the amount available. To increase the amount of available memory, increase the Glob Mem Adjust setting in the Printer control menu. The new buffer size only takes effect upon powering on, so perform a Save Config for the new setting and select that configuration as the Power-Up. The allowable range is 160 to 3600 Kbytes , and the factory default is 560 Kbytes .

ZGL EMULATION MODE (TABLE 4-11)	
MENU	DESCRIPTION
<div style="border: 1px solid black; padding: 2px; width: fit-content;">Host Form Length Enable*</div>	<p>Determines the method of setting the Label Length.</p> <ul style="list-style-type: none"> • Enable - factory default. Label length will be determined by the ^LL command if it is present. If the ^LL command is not present, it will be based on the Label Length value in the Quick Setup or Media Control menu. • Ignore - label length as determined by the ^LL command is ignored. • Disable - label length will be determined by the Label Length value in the Quick Setup or Media Control menu.
<div style="border: 1px solid black; padding: 2px; width: fit-content;">Left Position 0 dots*</div>	<p>The ^LS command specifies a horizontal offset to be added to all label element positions. The Left Position option displays the value specified by the ^LS command and provides an alternative method for specifying the horizontal offset.</p> <p>The factory default is 0 dots.</p>
<div style="border: 1px solid black; padding: 2px; width: fit-content;">Top Position 0 dots/inch*</div>	<p>The value of this option specifies a vertical offset to be added to all label element positions in dots per inch. For example, if the value is 3 and the current form length is 6 inches, then 18 dots will be added to the element's vertical position.</p> <p>The allowable range is -100 to +100 dots/inch, and the factory default is 0 dots/inch.</p>
<div style="border: 1px solid black; padding: 2px; width: fit-content;">Resolution Mode Full*</div>	<p>The ^JM command determines the apparent print resolution of the printed label.</p> <ul style="list-style-type: none"> • Full - factory default. The output is printed normally. The Resolution mode option displays and selects the current setting associated with the ^JM command. • Half - if selected by the ^JM command, the printed output of a 300 dpi printer matches that printed by a 150 dpi printer (half resolution). This essentially doubles the size of the label image, including label dimensions.
<div style="border: 1px solid black; padding: 2px; width: fit-content;">Vertical Adjust Enable*</div>	<p>Allows the vertical adjustment feature to be enabled or disabled.</p> <ul style="list-style-type: none"> • Disable - factory default. Vertical density adjustment will not take place. • Enable - is active and will use the Vertical Density value selected.
<div style="border: 1px solid black; padding: 2px; width: fit-content;">Vertical Density 207 dpi*</div>	<p>If Vertical Adjust is enabled, this option allows to fine tune the vertical print density (in the paper motion direction) on printers with 203 or 300 dpi print heads. The result is that the vertical position and height will be changed accordingly. Selecting a greater vertical density value causes the image to compress or expand vertically on the label.</p> <ul style="list-style-type: none"> • 203 DPI - the allowable range is 201 to 220 dpi, and the factory default is 207 dpi. • 300 DPI - the allowable range is 301 to 330 dpi, and the factory default is 300 dpi.
<div style="border: 1px solid black; padding: 2px; width: fit-content;">IS Label Fmt List Format*</div>	<p>This command saves the printed label image by name for later recall as part of a label definition and determines the internal format to be used. The storage location is determined by the option selected in the Storage Select menu.</p> <ul style="list-style-type: none"> • List Format - factory default. Used for most applications due to its greater efficiency of data process. • Bitmap Format - used in applications that frequently recall the saved label image. Results in greater print speed.
<div style="border: 1px solid black; padding: 2px; width: fit-content;">FB Width Adjust 0 dots*</div>	<p>Field Block Width Adjustment. This command allows the user to increase or decrease the width of field block from the field block command ^FB, so the text line in the block can be broken at a different word.</p> <p>The allowable range is -100 to +100 dots, and the factory default is 0 dots.</p>

Unit 4: Printer Configuration

ZGL EMULATION MODE (TABLE 4-11)	
MENU	DESCRIPTION
<div style="border: 1px solid black; padding: 5px;"> Storage Select B: = EMC* </div>	This menu allows the operator to map the device B: to an External Memory Cartridge or PC Board Flash. <ul style="list-style-type: none"> • B: = EMC - factory default. External Memory Cartridge. • B: = PCB Flash - PC Board Flash.
<div style="border: 1px solid black; padding: 5px;"> Network ID 0* </div>	Network Identification. Allows the operator to assign an identification number to the network. <ul style="list-style-type: none"> • 0 - factory default. Without identification. • 1 to 999 - a range of numbers to choose for identification.
<div style="border: 1px solid black; padding: 5px;"> Character Group Standard Set* </div>	Allows the language to be selected for the character group to represent. There are multiple languages from which to choose. The factory default is Standard Set .
<div style="border: 1px solid black; padding: 5px;"> Standard Sets USA 1* </div>	Allows further language clarification by choosing language options from a group within the Standard Set of characters. There are multiple languages from which to choose. The factory default is USA1 .



DGL EMULATION MODE (TABLE 4-12)	
MENU	DESCRIPTION
<div style="border: 1px solid black; padding: 5px;">  </div>	Permits entry into the EMULATION Mode.
<div style="border: 1px solid black; padding: 5px;"> EMULATION Select </div>	Allows the specific emulation to be selected or if the Select option is chosen, the menu to follow will contain a list of emulation options available.
<div style="border: 1px solid black; padding: 5px;"> Select DGL* </div>	Allows the selection of the specific emulation to be selected from a list. The allowable emulation options are: PGL for Printronics, ZGL for Zebra, TGL for TEC, IGL for Intermec, SGPL for SATO, and DGL for Datamax.

DGL EMULATION MODE (TABLE 4-12)	
MENU	DESCRIPTION
<div style="border: 1px solid black; padding: 5px;"> DGL Setup Active Character Set Euro Character Control Codes FeedBack Chars Default Module Units of Measure Row Offset Column Offset Format Attrib. Error Handling Vert. DPI Adjust Compatibility Length Cmd (STXc) Heat Cmd (H) Speed Cmd (P,S) Cut Cmd (o,.,c) Soft. Switch (V) Sensor Cmd (e,r) Format Attr. (A) </div>	Is the menu selection screen for the EMUALTION Mode.
<div style="border: 1px solid black; padding: 5px;"> Active Yes* </div>	This menu determines if the DGL parser will possess all incoming data or pass all data to the underlying emulation. <ul style="list-style-type: none"> • Yes - factory default. DGL is active; processes all DPL commands. • No - DGL is inactive; the data is processed by the underlying emulation.
<div style="border: 1px solid black; padding: 5px;"> Character Set PC-8 CP 437* </div>	Allows selection of the character set desired for the printer to use to inter-operate with the characters sent from the host system. There are multiple languages from which to choose. The factory default is PC-8 CP437 .
<div style="border: 1px solid black; padding: 5px;"> Euro Character 128* </div>	Allows the Euro character position in the code page to be selected. Select the ASCII character (in decimal format) desired to represent the Euro character. The factory default is 128 .
<div style="border: 1px solid black; padding: 5px;"> Control Codes Standard* </div>	Allows the operator to change the software command prefix interpreted by the printer. When User Defined is selected, five additional submenus are inserted into the menu tree. These submenus allow the user to set a value for each of the control codes. The default User Defined values are shown below.
<div style="border: 1px solid black; padding: 5px;"> FeedBack Chars Disable* </div>	Feedback Characters. Determines if the printer returns aHex 1E (RS) after each label successfully prints and a Hex 1F (US) after each batch of labels printed. <ul style="list-style-type: none"> • Disable - factory default. Feedback characters are not sent to the host. • Enable - feedback characters are sent to the host.
<div style="border: 1px solid black; padding: 5px;"> Default Module RAM* </div>	Sets the default module used to store files when a module is not specified or the default module is specified in the command. <ul style="list-style-type: none"> • RAM - factory default. Storage in volatile RAM where the data will be lost when the printer is powered off. • Flash - Storage in non-volatile Flash where the data will remain unless actively removed.

DGL EMULATION MODE (TABLE 4-12)	
MENU	DESCRIPTION
<div style="border: 1px solid black; padding: 2px; width: fit-content; margin: auto;"> Units of Measure Imperial* </div>	<p>Selects how the printer will interpret measurements.</p> <ul style="list-style-type: none"> • Imperial - factory default. American Standard values. • Metric - uses Metric values. <p>Note: <STX>n and <STX>m commands override this setting and will stay in effect until the printer is taken offline, then returned online.</p>
<div style="border: 1px solid black; padding: 2px; width: fit-content; margin: auto;"> Row Offset 00.00 Inch* </div>	<p>Shifts the vertical start of the print position. This is the user setting for row adjustment. The allowable range is 0 to 99.99 inches or 999.9 millimeters. The factory default is 0.</p> <p>Note: The Label Formatting command (R) only temporarily overrides this setting; it reverts back to this setting after the current label format is finished.</p>
<div style="border: 1px solid black; padding: 2px; width: fit-content; margin: auto;"> Column Offset 00.00 Inch* </div>	<p>Shifts the horizontal, left-justified start position to the right without shifting the Label Width termination point to the right. This is the user setting for row adjustment. The allowable range is 0 to 99.99 inches or 999.9 millimeters. The factory default is 0.</p> <p>Note: The Label Formatting command (C) only temporarily overrides this setting; it reverts back to this setting after the current label format is finished.</p>
<div style="border: 1px solid black; padding: 2px; width: fit-content; margin: auto;"> Format Attrib. XOR* </div>	<p>Format Attribute. Affects the manner in which overlapping text and graphics are treated as the label is printed.</p> <ul style="list-style-type: none"> • XOR - factory default. Intersecting text strings, images, and barcodes print on top of one another. • Transparent - intersecting text strings, images, and barcodes will not be printed. An odd quantity of overlapping objects will print. • Opaque - intersecting text strings, images, and barcodes are obliterated by those last formatted. Each character cell is treated as opaque.
<div style="border: 1px solid black; padding: 2px; width: fit-content; margin: auto;"> Error Handling Off* </div>	<p>Defines how the emulation handles errors detected in the data stream. For all selections, data processing will not be aborted when errors are detected and labels will be printed as best possible. Commands containing errors will be ignored.</p> <ul style="list-style-type: none"> • Off - factory default. Without signals to the user when errors are detected. • Report - the printer will beep when one or more errors are detected and the first command that contains an error is displayed on the printer's LCD in mnemonic form. • Beep - the printer will beep once if one or more errors are detected.
<div style="border: 1px solid black; padding: 2px; width: fit-content; margin: auto;"> Vert. DPI Adjust 0* </div>	<p>This option fine adjusts the resolution used to scale the page elements/coordinates. In cases where the printed label length is incorrect, the vertical resolution value DGL uses for calculations can be fine adjusted by this menu. Negative values result in a lower DPI value and thus a longer label. Positive values result in a higher DPI value, and thus a shorter label. The allowable range is -100 to +100, with a factory default of 0.</p>
<div style="border: 1px solid black; padding: 2px; width: fit-content; margin: auto;"> Compatibility Standard* </div>	<p>Determines compatibility with legacy Datamax emulations.</p> <ul style="list-style-type: none"> • Standard - factory default. Standard emulation. • S-462 - specific printer model.
<div style="border: 1px solid black; padding: 2px; width: fit-content; margin: auto;"> Length Cmd (STXc) Process* </div>	<p>Allows the user to disable the Length Command.</p> <ul style="list-style-type: none"> • Process - factory default. Acknowledges length commands. • Ignore - does not acknowledge length commands.

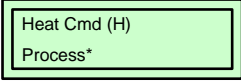
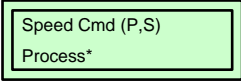
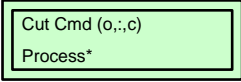
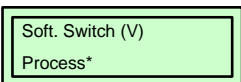
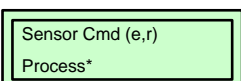
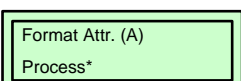
Unit 4: Printer Configuration

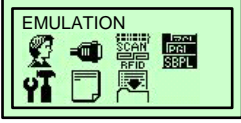
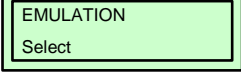

DGL EMULATION MODE (TABLE 4-12)	
MENU	DESCRIPTION
	<p>Determines whether the print intensity commands processed by the printer will be those sent from a host or those set by the printer's operator panel.</p> <ul style="list-style-type: none"> • Process - factory default. Downloaded commands take precedence. • Ignore - downloaded commands are ignored and printer settings take precedence.
	<p>Allows the user to disable the speed commands (Print, Feed, Reverse).</p> <ul style="list-style-type: none"> • Process - factory default. Acknowledges speed commands. • Ignore - does not acknowledge speed commands.
	<p>Allows the user to disable the commands affecting the cutter assembly.</p> <ul style="list-style-type: none"> • Process - factory default. Acknowledges cutter commands. • Ignore - does not acknowledge cutter commands.
	<p>Allows the selection of how the printer will respond to the software switch settings of <ESC>V commands. this command enables Cut or Tear-Off mode, or disables both by selecting Continuous mode.</p> <ul style="list-style-type: none"> • Process - factory default. Responds to the commands. • Ignore - does not respond to the commands.
	<p>Allows the selection of how the printer will respond to various sensor commands.</p> <ul style="list-style-type: none"> • Process - factory default. Acknowledges sensor commands. • Ignore - does not acknowledge sensor commands.
	<p>Allows the user to disable the commands that select the Format Attribute.</p> <ul style="list-style-type: none"> • Process - factory default. Acknowledges commands that select formatting attributes. • Ignore - does not acknowledge commands that select formatting attributes.

TGL EMULATION MODE (TABLE 4-13)	
MENU	DESCRIPTION
	<p>Permits entry into the EMULATION Mode.</p>
	<p>Allows the specific emulation to be selected or if the Select option is chosen, the menu to follow will contain a list of emulation options available.</p>
	<p>Allows the selection of the specific emulation to be selected from a list.</p> <p>The allowable emulation options are: PGL for Printronics, ZGL for Zebra, TGL for TEC, IGL for Intermec, SGPL for SATO, and DGL for Datamax.</p>

TGL EMULATION MODE (TABLE 4-13)	
MENU	DESCRIPTION
<div style="border: 1px solid black; padding: 5px; width: fit-content;"> TGL Setup Active Print Errors Character Set Slash Zero Image Scale SFCC Select EURO Symbol Speed CMDs AY Intensity CMD U1/U2 Move CMDs XS Sensor Param XS Media 'C' Act XS Media 'D' Act AR Pre-Feed CMD AX Fine Adj. CMD Page alignment Vert. DPI Adjust Status Response </div>	Is the menu selection screen for the EMULATION Mode.
<div style="border: 1px solid black; padding: 5px; width: fit-content;"> Active Yes* </div>	Allows the selection of how the printer will respond to non-TGL format text to either be printed or ignored. <ul style="list-style-type: none"> • Yes - factory default. All data is parsed by the TGL emulation. Non-TGL data is absorbed. • No - all data is is passed to the LP+ emulation. For information on setting the LP+ Text Mode through the host data stream, refer to the TGL Programming Reference manual.
<div style="border: 1px solid black; padding: 5px; width: fit-content;"> Print Errors Disable* </div>	Determines where and how errors will be displayed. <ul style="list-style-type: none"> • Disable - factory default. Errors display only on the printer's LCD. • Enable - errors are printed and displayed on the printer's LCD.
<div style="border: 1px solid black; padding: 5px; width: fit-content;"> Character Set PC-850* </div>	Allows the character set to be selected. The options are PC-850 , PC-8 , or 8859-2 Latin 2 . The factory default is PC-850 .
<div style="border: 1px solid black; padding: 5px; width: fit-content;"> Slash Zero Disable* </div>	Determines if a zero numeral will be printed with a diagonal slash. <ul style="list-style-type: none"> • Disable - factory default. The zero character does not have a slash. • Enable - the zero character is overlaid with a slash.
<div style="border: 1px solid black; padding: 5px; width: fit-content;"> Image Scale Disable* </div>	Determines if an imaged will be scaled according to the printer's print resolution. <ul style="list-style-type: none"> • Disable - factory default. Scaling will not take place, resulting in images that are 2% larger than images printed on the TEC printer. The image will maintain the correct proportions and result in faster printing. • Enable - images are scaled from TEC printer resolution (306 dpi) to the resolution of the TGL printer (300 dpi).

TGL EMULATION MODE (TABLE 4-13)	
MENU	DESCRIPTION
<div style="border: 1px solid black; padding: 2px; width: fit-content; margin: auto;"> SFCC Select Auto Select* </div>	<p>Special Function Control Code. These codes are specific to the delimiters of separate print jobs and commands. They can be customized and therefore changed via this menu so the printer can recognize these alternate control characters.</p> <ul style="list-style-type: none"> • Auto Select - factory default. The printer selects the SFCC set based upon the received host data. • <ESC><LF><NUL> - is a predefined set. The ESC character is the SFCC, the LF is the SFCC-Separator, and the NULL character is the SFCC-Terminator. • { I } - is a predefined set. The { character is the SFCC, the I is the SFCC-Separator, and the } is the SFCC-Terminator. • User Defined - if this option is selected, three additional menus appear. These menus allow the SFCC, SFCC-Separator, and SFCC-Terminator to be individually configured. <ul style="list-style-type: none"> • SFCC - can set value between 0x0 and 0xFF. The factory default is 0x7B. • SFCC Separator - can set value between 0x0 and 0xFF. The factory default is 0x7C. • SFCC Terminator - can set value between 0x0 and 0xFF. The factory default is 0x7D.
<div style="border: 1px solid black; padding: 2px; width: fit-content; margin: auto;"> EURO Symbol 0xB0* </div>	<p>This menu allows the position of the EURO symbol in the cold pages to be configured. The EURO symbol can be set to any value between 0x20 and 0xFF. The factory default is 0xB0.</p>
<div style="border: 1px solid black; padding: 2px; width: fit-content; margin: auto;"> Speed CMDs Process* </div>	<p>Speed Commands. Determines if engine commands that affect the print/feed speed will be processed or ignored. To adjust the print/feed speed through the operator panel, use this menu to prevent the host commands from overriding these settings. When Ignore is selected, the TGL ignores the following commands or command parameters:</p> <ul style="list-style-type: none"> • The print speed parameter in the XS command. The parameter will not have an effect; the Print Speed value as configured in the Media Control menu will be used. • The feed speed parameter in the T command. The parameter will not have an effect; the Slow Speed value as configured in the Media Control menu will be used. <p>The factory default is Process.</p>
<div style="border: 1px solid black; padding: 2px; width: fit-content; margin: auto;"> AY Intensity CMD Process* </div>	<p>Allows the selection of how the printer will respond to print intensity (darkness) commands.</p> <ul style="list-style-type: none"> • Process - factory default. Sent commands from the host take precedence. • Ignore - printer settings take precedence.
<div style="border: 1px solid black; padding: 2px; width: fit-content; margin: auto;"> U1/U2 Move CMDs Process* </div>	<p>Allows the selection of how the printer will respond to commands to move paper forward (U1) or backward (U2).</p> <ul style="list-style-type: none"> • Process - factory default. Sent commands from the host take precedence. • Ignore - printer settings take precedence. The paper will not be moved when either command is received.
<div style="border: 1px solid black; padding: 2px; width: fit-content; margin: auto;"> XS Sensor Param Process* </div>	<p>XS Sensor Parameter. Allows the selection of how the printer will respond to the XS command setting the sensor type parameters.</p> <ul style="list-style-type: none"> • Process - factory default. Sent commands from the host take precedence. • Ignore - printer settings take precedence. The paper will not be moved when either command is received. TGL will use the sensor type as configured through Gap/Mark Sensor under the Calibrate CTRL menu.
<div style="border: 1px solid black; padding: 2px; width: fit-content; margin: auto;"> XS Media 'C' Act Continuous* </div>	<p>Defines which media mode TGL will operate on receipt of a 'C' (strip mode) from the issue mode parameter in the XS command. Any of the supported media modes can be selected.</p> <ul style="list-style-type: none"> • Continuous - factory default. Sent commands from the host take precedence. • Ignore - will use the issue mode as configured through Media Handling under the Media Control menu.

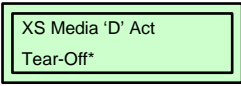
Unit 4: Printer Configuration

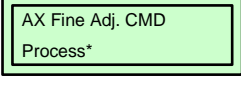
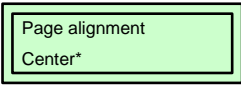
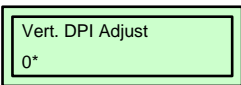
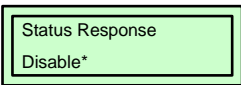
TGL EMULATION MODE (TABLE 4-13)	
MENU	DESCRIPTION
	<p>Defines which media mode TGL will operate on receipt of a 'D' (strip mode) from the issue mode parameter in the XS command. Any of the supported media modes can be selected. When Ignore is selected, TGL will use the issue mode as configured through Media Handling under the Media Control menu.</p> <p>The factory default is Tear-Off.</p>
	<p>AR Pre-Feed Command. Allows the selection of how the printer will respond to command for a paper pre-feed (AR).</p> <ul style="list-style-type: none"> • Process - factory default. Sent commands from the host take precedence. • Ignore - printer settings take precedence. The paper will not pre-feed.
	<p>AX Fine Adjustment Command. Allows the selection of how the printer will respond to command for a position fine adjustment (AX).</p> <ul style="list-style-type: none"> • Process - factory default. Sent commands from the host take precedence. • Ignore - printer settings take precedence. The paper will not fine adjust.
	<p>This menu is used to define the alignment of the image on the page.</p> <ul style="list-style-type: none"> • Center - factory default. Evenly spaced using the page width set in the configuration. • Left - aligned to the left side. When printing in the Portrait mode, the image's top will exit the printer first. Inverted Portrait mode, the image's bottom will exit the printer first.
	<p>Allows for fine adjustment of print the resolution used to convert coordinates of page elements (barcodes, font fields, graphic images, lines, boxes). The coordinates received from the host are in 1/10 millimeters and are converted to engine resolution (203 or 300 dpi).</p> <p>In cases where the printed image length is incorrect, the vertical resolution value TGL uses for calculations can be fine adjusted between -100 and +100. Negative values result in a lower dpi value and thus a shorter image. This adjustment does not affect the size of fonts and barcodes, only the coordinates.</p> <p>The factory default is 0.</p>
	<p>Allows the selection of how the printer will respond to command to the WS command for status responses from the printer.</p> <ul style="list-style-type: none"> • Disable - factory default. Will not process commands. • Enable - will process commands.

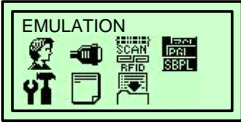
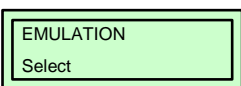
IGL EMULATION MODE (TABLE 4-14)	
MENU	DESCRIPTION
	<p>Permits entry into the EMULATION Mode.</p>
	<p>Allows the specific emulation to be selected or if the Select option is chosen, the menu to follow will contain a list of emulation options available.</p>

IGL EMULATION MODE (TABLE 4-14)	
MENU	DESCRIPTION
<div style="border: 1px solid black; padding: 5px; width: fit-content;"> Select IGL* </div>	Allows the selection of the specific emulation to be selected from a list. The allowable emulation options are: PGL for Printronics, ZGL for Zebra, TGL for TEC, IGL for Intermec, SGPL for SATO, and DGL for Datamax.
<div style="border: 1px solid black; padding: 5px;"> IGL Setup Active Error Reporting Mode on Power Up Print Language IBM Translation Slash Zero EURO-Symbol Preparsing Data Status on <ETX> Cutter Cmd (c) PwrUpMod Cmd (C) EOP Dist Cmd (D) Intens. Cmd (d) TOF set Cmd (F) LRP adj. Cmd (f) Speed Cmd (S) Stock Cmd (T) Vert. DPI Adjust Reported model Saving UDCs Save state </div>	Is the menu selection screen for the EMULATION Mode.
<div style="border: 1px solid black; padding: 5px; width: fit-content;"> IGL Setup Active* </div>	Allows transition to the Active menu screen.
<div style="border: 1px solid black; padding: 5px; width: fit-content;"> Active Yes* </div>	Allows for non-IGL formatted text to either be printed or ignored. <ul style="list-style-type: none"> • Yes - factory default. All data is parsed by the PPI/IGL emulation. Non-PPI/IGL data is absorbed. • No - all data is is passed to the LP+ emulation.
<div style="border: 1px solid black; padding: 5px; width: fit-content;"> Error Reporting Display on LCD* </div>	Determines where and how errors in the data stream will be displayed. <ul style="list-style-type: none"> • Display on LCD - factory default. Error will display on the printer's LCD. Upon detection, the printer will beep once. Each error will display for a half second, then the printer will go offline and will print the data as best possible. • Disable - errors are printed as best possible, but not displayed on the printer's LCD.
<div style="border: 1px solid black; padding: 5px; width: fit-content;"> Mode on Power Up Advanced 5mil* </div>	Allows the selection of the printer's print resolution. <ul style="list-style-type: none"> • Advanced 5mil - factory default. Standard for 203 dpi. • Emulation 10mil - for 100 dpi. • Emulation 15mil - for 67 dpi. <p>Note: This menu does not appear when a 300 dpi print head is installed. When a 300 dpi print head is installed, the mode will always be Advanced 3.3mil.</p>
<div style="border: 1px solid black; padding: 5px; width: fit-content;"> Print Language US ASCII* </div>	This menu selects the printed character language. The factory default is US ASCII.

IGL EMULATION MODE (TABLE 4-14)	
MENU	DESCRIPTION
<div style="border: 1px solid black; padding: 5px; width: fit-content; margin: auto;"> IBM Translation Disable* </div>	Select whether the data sent to the printer is translated as standard ASCII or EBCDIC. Many IBM Mini/Main-Frame computers use EBCDIC which does not directly translate to ASCII. <ul style="list-style-type: none"> • Disable - factory default. The IBM version of the selected character will not be used. • Enable - the IBM version of the selected character set will be used.
<div style="border: 1px solid black; padding: 5px; width: fit-content; margin: auto;"> Slash Zero Font Based* </div>	This menu determines if a zero numeral character will be printed with a diagonal slash overlaid. <ul style="list-style-type: none"> • Font Based - factory default. Zero characters will print with a slash if the selected font type designates that it has one. This mimics IPL3 printers where not all fonts contain a slashed zero. • Disable - factory default. Zero characters are never printed with a slash. • Enable - all zero characters will be printed with a slash, independent of the selected font.
<div style="border: 1px solid black; padding: 5px; width: fit-content; margin: auto;"> EURO Symbol 0x0* </div>	This menu defines the code page position that contains the the Euro symbol. The factory default is 0x0 .
<div style="border: 1px solid black; padding: 5px; width: fit-content; margin: auto;"> Preparing data Disable* </div>	Select whether the data is to be processed as it is received or if the printer is to wait until the entire job has been sent prior to any commands being processed. This menu determines if the data preparer will be active or inactive. <ul style="list-style-type: none"> • Enable - factory default. The data received from the host is preprocessed to quickly respond to the immediate commands. • Disable - the data is processed synchronously; the commands are not processed until all preceding commands have been processed.
<div style="border: 1px solid black; padding: 5px; width: fit-content; margin: auto;"> Status on <ETX> Enable* </div>	This menu determines if a printer status message will be returned to the host on receipt of the block terminator <ETX>. This is implemented only for serial interface, X-On/X-Off, or Intermecc protocol. <ul style="list-style-type: none"> • Disable - factory default. Will not send status message. • Enable - will send status message.
<div style="border: 1px solid black; padding: 5px; width: fit-content; margin: auto;"> Cutter Cmd (c) Process* </div>	Cutter Command. This menu defines if the <ESC>Sic command which enables or disables the cutter assembly is acknowledged. <ul style="list-style-type: none"> • Process - factory default. Acknowledges cutter commands. • Ignore - does not acknowledge cutter commands.
<div style="border: 1px solid black; padding: 5px; width: fit-content; margin: auto;"> PwrUpMod Cmd (C) Process* </div>	Power Up Mode Command. This menu defines if the <ESC>SIC command which selects the Emulation or Advanced power up mode is acknowledged. <ul style="list-style-type: none"> • Process - factory default. Acknowledges the commands. • Ignore - does not acknowledge the commands.
<div style="border: 1px solid black; padding: 5px; width: fit-content; margin: auto;"> EOP Dist Cmd (D) Process* </div>	End-Of-Print Distance Command. This menu defines if the <ESC>SID command is acknowledged. <ul style="list-style-type: none"> • Process - factory default. Acknowledges the commands. • Ignore - does not acknowledge the commands.
<div style="border: 1px solid black; padding: 5px; width: fit-content; margin: auto;"> Intens. Cmd (d) Process* </div>	Intensity Command. This menu defines if the <ESC>SId command which sets print darkness is acknowledged. <ul style="list-style-type: none"> • Process - factory default. Acknowledges the commands. • Ignore - does not acknowledge the commands.

IGL EMULATION MODE (TABLE 4-14)	
MENU	DESCRIPTION
<div style="border: 1px solid black; padding: 5px; width: fit-content; margin: auto;"> TOF set Cmd (F) Process* </div>	<p>Top-Of-Form Set Command. This menu defines if the <ESC>SIF command which sets the start print point, is acknowledged.</p> <ul style="list-style-type: none"> • Process - factory default. Acknowledges the commands. • Ignore - does not acknowledge the commands.
<div style="border: 1px solid black; padding: 5px; width: fit-content; margin: auto;"> LRP adj. Cmd (f) Process* </div>	<p>Label Rest Point Adjust Command. This menu defines if the <ESC>Sif command is acknowledged.</p> <ul style="list-style-type: none"> • Process - factory default. Acknowledges the commands. • Ignore - does not acknowledge the commands.
<div style="border: 1px solid black; padding: 5px; width: fit-content; margin: auto;"> Speed Cmd (S) Process* </div>	<p>This menu defines if the <ESC>SIS command which set print speed is acknowledged.</p> <ul style="list-style-type: none"> • Process - factory default. Acknowledges the commands. • Ignore - does not acknowledge the commands. <p>Note: If the print/feed speed is adjusted using the operator panel, host commands will not override operator panel settings.</p>
<div style="border: 1px solid black; padding: 5px; width: fit-content; margin: auto;"> Stock Cmd (T) Process* </div>	<p>Stock Command. This menu defines if the <ESC>SIT command which sets media handling is acknowledged.</p> <ul style="list-style-type: none"> • Process - factory default. Acknowledges the commands. • Ignore - does not acknowledge the commands.
<div style="border: 1px solid black; padding: 5px; width: fit-content; margin: auto;"> Vert. DPI Adjust 0* </div>	<p>Vertical Dots-Per-Inch Adjustment. This menu fine adjusts the resolution used to convert the coordinates of page elements (barcodes, font fields, graphic images, lines, boxes). The coordinates received from the host are converted to engine resolution (203 or 300 dpi).</p> <p>In cases where the printed label length is incorrect, the vertical resolution value IGL uses for calculations can be fine adjusted.</p> <p>Negative values result in a lower DPI value and thusly, a longer label. Positive values result in a higher DPI value and thusly, a shorter label.</p> <p>The allowable range is -100 to +100 with a factory default of 0.</p> <p>Note: This adjustment does not affect the size of fonts and barcodes.</p>
<div style="border: 1px solid black; padding: 5px; width: fit-content; margin: auto;"> Reported model Auto detect* </div>	<p>This menu defines which printer model IGL reports on the <ESC>M command. Manual selection may be needed in cases where the auto-detected Intermec model does not support a feature wanted. For example, TrueType font download is not supported on an Intermec 3600 printer. IGL always supports this feature. To download TrueType fonts via the Intermec utility, the user can set the model to 4420E which does support this download. This setting only affects the model reported to the host - it will not affect the IGL in any other way.</p> <ul style="list-style-type: none"> • Auto Detect - factory default. Will report a model that cooresponds with the actual width and resolution of the printer running IGL. • 3600 - printer model. • 4420E - printer model. • 4630 - printer model. • 4830 - printer model.
<div style="border: 1px solid black; padding: 5px; width: fit-content; margin: auto;"> Saving UDCs Automatic* </div>	<p>Saving User-Defined-Characters. This menu defines if UDC's are automatically saved to flash or manually via the Save State menu.</p> <ul style="list-style-type: none"> • Automatic - factory default. The file system can run full because it is not automatically optimized. • Use Save State - used in cases where UDC's are sent repeated for each label.

Unit 4: Printer Configuration

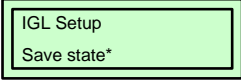
IGL EMULATION MODE (TABLE 4-14)	
MENU	DESCRIPTION
	<p>This menu saves the current state of the printer to flash memory. The pages, formats, and fields that currently exist in RAM memory save to flash memory and are restored at power up. This allows the format to be sent once and make it resident in the printer.</p> <p>Note: Saving the state does not save general printer settings for which configuration menus are provided. These settings are saved by storing the configuration, and selecting that configuration as the power up configuration. Examples of settings that can be configured this way by host control are print speed, print density, and media handling (continuous, tear-off, etc.).</p>

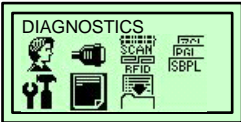
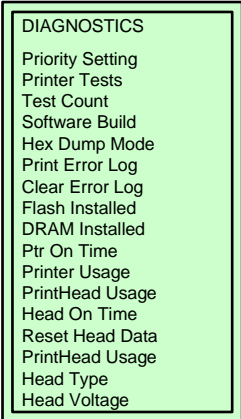
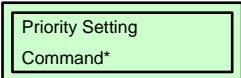
DIAGNOSTICS MODE (TABLE 4-15)	
MENU	DESCRIPTION
	<p>Permits entry into the DIAGNOSTICS Mode.</p>
	<p>Is the menu selection screen for the DIAGNOSTICS Mode.</p>
	<p>Allows the selection of which type of programming will take priority precedence in determining Print Darkness, Print Speed, and Print Offset.</p> <ul style="list-style-type: none"> • Command - factory default. Any commands in the label job will take precedence and be used for printing. The LCD will reflect the new setting. • LCD - Any settings established through the printer's operator panel will be used for an incoming print job regardless of different command settings.

DIAGNOSTICS MODE (TABLE 4-15)	
MENU	DESCRIPTION
<div style="border: 1px solid black; padding: 2px; margin-bottom: 5px;">Printer Tests</div> <div style="border: 1px solid black; padding: 2px;">Checkerboard*</div>	<p>Allows verification of proper printer operation and print quality through the selection of various test print options.</p> <ul style="list-style-type: none"> • Checkerboard - factory default. Helps identify marginal print head elements, edge sharpness, and uneven print quality. • Grey - helps identify burned out print head elements and uneven print quality. • Grid - helps identify edge sharpness and uneven print quality. • Current Config. - prints the current printer configuration and helps determine text print quality. • Left Test - prints a pattern containing a series of ladder-type bar code symbols starting with four and decrementing by one symbol on each print until a single symbol prints on the left side. • Right Test - prints a pattern containing a series of ladder-type bar code symbols starting with four and decrementing by one symbol on each print until a single symbol prints on the right side. • Combo Test - prints a combined left and right side test. • Ethernet Test - prints the NIC statistics stored on its adapter. Only appears if the Network Interface Card (NIC) adapter is installed. • Barcode Demo - prints text and barcodes with the barcodes positioned at the left and right margins of the standard label media supplied with the printer. The test automatically produces output for 4 inch printers at 203 and 305 dpi. • RFID Report - prints a report of RFID statistics since the printer was powered on or since the last data reset. Once the desired test pattern is chosen, press ENTER to start printing. If the Test Count option is set to Continuous (factory default), press ENTER again to stop printing. Only appears if the RFID encoder is installed.
<div style="border: 1px solid black; padding: 2px; margin-bottom: 5px;">Test Count</div> <div style="border: 1px solid black; padding: 2px;">5 Pages*</div>	<p>This menu screen enables the quantity of times the selected test pattern will be printed. The options are Continuous (factory default), 1 Page, 2 Pages, 5 Pages, and 10 Pages.</p>
<div style="border: 1px solid black; padding: 2px; margin-bottom: 5px;">Software Build</div> <div style="border: 1px solid black; padding: 2px;">XXXXXX VX.XXX</div>	<p>This menu screen allows the entry of the reference number which includes the program file part number and the revision number of the software installed in the printer (e.g., 358186 V1.07G).</p>
<div style="border: 1px solid black; padding: 2px; margin-bottom: 5px;">Hex Dump Mode</div> <div style="border: 1px solid black; padding: 2px;">Disable*</div>	<p>Allows the determination of whether the printer will print a label containing data sent from the host in hexadecimal format.</p> <ul style="list-style-type: none"> • Disable - factory default. Will not print. • Enable - will print.
<div style="border: 1px solid black; padding: 2px; margin-bottom: 5px;">DIAGNOSTICS</div> <div style="border: 1px solid black; padding: 2px;">Print Error Log</div>	<p>This menu screen permits the printing of the current log of errors. Most non-routine faults (Ribbon Fault, Print Head Hot) are stored in the error log.</p>
<div style="border: 1px solid black; padding: 2px; margin-bottom: 5px;">DIAGNOSTICS</div> <div style="border: 1px solid black; padding: 2px;">Clear Error Log</div>	<p>Is a subset of menu screens that permits the error log to be cleared.</p>

Unit 4: Printer Configuration

DIAGNOSTICS MODE (TABLE 4-15)	
MENU	DESCRIPTION
<div style="border: 1px solid black; padding: 5px; width: fit-content;">Error Log Clear</div>	Is an informational screen that displays that the error log is clearing.
<div style="border: 1px solid black; padding: 5px; width: fit-content;">DIAGNOSTICS FLASH Installed 8 Megabytes</div>	Is an informational screen that displays the amount of flash memory installed.
<div style="border: 1px solid black; padding: 5px; width: fit-content;">DIAGNOSTICS DRAM Installed 32 Megabytes</div>	Is an informational screen that displays the amount of DRAM installed.
<div style="border: 1px solid black; padding: 5px; width: fit-content;">DIAGNOSTICS Ptr On Time XXXXX.X Hours</div>	Is an informational screen that displays the cumulative time in hours the printer has been powered on. This value is set to zero at the factory following testing.
<div style="border: 1px solid black; padding: 5px; width: fit-content;">DIAGNOSTICS Printer Usage XXXXX.X Meters</div>	Is an informational screen that displays the cumulative distance the printer has moved media. This value is set to zero at the factory following testing.
<div style="border: 1px solid black; padding: 5px; width: fit-content;">DIAGNOSTICS PrinterHead Usage XXXXX.X Meters</div>	Is an informational screen that displays the length of media actually printed since the last Reset Head Data operation. This value is set to zero at the factory following testing.
<div style="border: 1px solid black; padding: 5px; width: fit-content;">DIAGNOSTICS Head On Time XX.X Hours</div>	Is an informational screen that displays the cumulative time that power has been applied to the print head since the last Reset Head Data operation. This value is set to zero at the factory following testing.
<div style="border: 1px solid black; padding: 5px; width: fit-content;">DIAGNOSTICS Reset Head Data</div>	Is a subset of menus that allows the operator to reset all print head statistics values (Head Prt Dist, Head On Time) to zero.
<div style="border: 1px solid black; padding: 5px; width: fit-content;">Resetting Head Data</div>	Is an informational screen that displays that the head data is clearing.

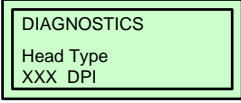
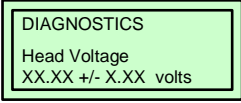

Unit 4: Printer Configuration

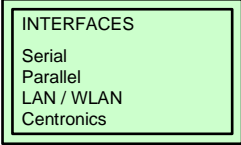
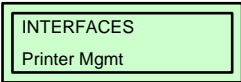
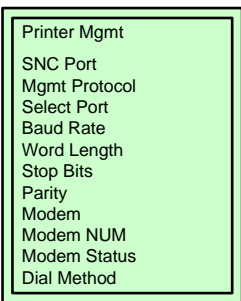
DIAGNOSTICS MODE (TABLE 4-15)	
MENU	DESCRIPTION
	Is an informational screen that displays the print head resolution in stalled in dots per inch (203 or 305 dpi).
	Is an informational screen that displays the applied print head voltage.

PRINTER MANAGEMENT MODE (TABLE 4-16)	
MENU	DESCRIPTION
	Permits entry into the INTERFACES Mode.
	Is the menu selection screen for the INTERFACES Mode.
	Allows entry into the Printer Management Mode from the INTERFACES Mode.
	Is the menu selection screen for the Printer Management Mode.

PRINTER MANAGEMENT MODE (TABLE 4-16)	
MENU	DESCRIPTION
<div style="border: 1px solid black; padding: 5px;"> Printer Mgmt SNC Port Mgmt Protocol SNC Port Number SNC Port Timeout Status Port Numb Mgmt Port Number </div>	Is the menu selection screen for the Printer Management Mode.
<div style="border: 1px solid black; padding: 5px;"> SNC Port Disable* Serial Ethernet </div>	SATO Net Connect Port. Allows selection of which port the printer expects SNC to connect with via Ethernet or Serial. <ul style="list-style-type: none"> • Disable - factory default. Not activated. • Serial - connects to serial port. • Ethernet - connect to ethernet port.
<div style="border: 1px solid black; padding: 5px;"> Mgmt Protocol PXML* </div>	This menu selects the active Management Protocol Interface. Any system that supports the XML standards and schemas can work with PXML. UCP is used mostly for GPIO (General Purpose Input/Output) devices. Since PXML and UCP management protocols share the same Ethernet port, only one can be active at a time. The options are PXML or UCP , and the factory default is UCP .
<div style="border: 1px solid black; padding: 5px;"> Status Port Numb XXXXX* </div>	This menu selects the port number the printer sends the emulation status. This is the Ethernet port number the emulations can use to communicate status to the host computer. The allowable range is 1023 to 65535 , and the factory default is 3001 .
<div style="border: 1px solid black; padding: 5px;"> Mgmt Port Number XXXXX* </div>	Allows the Ethernet port number to be selected that the PXML or UCP will use to communicate to the printer. This is the Ethernet Port number the PXML or UCP will use to communicate to the printer.
<div style="border: 1px solid black; padding: 5px;"> SNC Port Number XXXXX* </div>	This menu selects the port number the printer expects the SNC to connect through. The allowable range is 1023 to 65535 , and the factory default is 3001 .
<div style="border: 1px solid black; padding: 5px;"> SNC Port Timeout 100 seconds* </div>	If the SNC has not communicated to the printer within the period specified here, the SNC session closes. The allowable range is 1 to 255 seconds , and the factory default is 100 .
<div style="border: 1px solid black; padding: 5px;"> Select Port Debug* Host </div>	Allows the appropriate port option to be chosen. <ul style="list-style-type: none"> • Debug - factory default. If the PNE port is set to Serial, then the PNE will communicate through the Debug Serial Port. • Host - if PNE is set to Serial, the PNE will communicate through the Host Serial Port. This cannot be selected if the host interface is set to Auto-Switch or Serial.

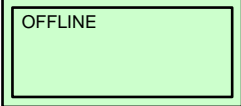
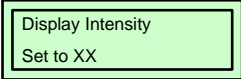
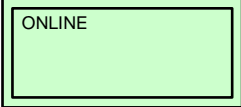
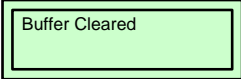
PRINTER MANAGEMENT MODE (TABLE 4-16)	
MENU	DESCRIPTION
Deselect Serial Host Interface	This menu disables the serial port.
Baud Rate 19200*	Allows setting the baud rate for the serial interface. The baud rate is the speed serial data is transferred between the host computer and the printer. The options for RS232 and RS422 are 600, 1200, 2400, 4800, 9600, 19200, 38400, 57600, and 115200 baud. Note: If using RS232 and the selected baud rate is greater than 19200, data loss may occur. To correct this, it may be necessary to lower the baud rate or use RS422. An increase in the Buffer Size in K parameter from the default (1 Kbyte) may be required to improve performance. The factory default is 9600 .
Word Length 8*	This menu allows the length of the serial data word to be set. The data word length can be set to 7 or 8 bits and must match the corresponding data bits setting in the host computer. The factory default is 8 .
Stop Bits 1*	This menu allows the quantity of stop bits in the serial word to be set. either 1 or 2 stop bits may be selected, but the setting must match the corresponding stop bit setting in the host computer.
Parity None*	This menu screen allows the parity to be set, but the setting must match that of the host computer. The options are: Odd, Even, Mark, Sense, or None . The factory default is None .
Modem Disable*	Determines the modem status. <ul style="list-style-type: none">• Disable - factory default. Is not active.• Enable - is active.
Modem NUM Enable*	Determines if the modem's NVM stored configuration will be used or if the printer will send a modem initialization string. <ul style="list-style-type: none">• Enable - factory default. The printer will only send a ATZ0 command to the modem on power-up. Resets the modem configuration to 0.• Disable - the printer sends a generic modem initialization string on power-up. NOTE: This generic initialization string does not work for all modem types. If the initialization string does not work, the modem must be manually configured, the setting must be stored in configuration 0, and the printer "Modem NVM menu must be enabled.
Modem Status Enable*	Determines if the modem's status will be displayed on the printer's operator panel. <ul style="list-style-type: none">• Enable - factory default. Will display status commands.• Disable - does not display status commands.
Dial Method Tone*	Determines the modem's communication method. <ul style="list-style-type: none">• Tone - factory default. Uses the tone dialing method.• Pulse - uses the pulse dialing method.

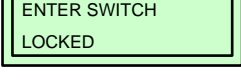
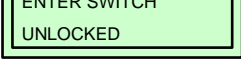
QUICK MENUS (TABLES 4-17 THROUGH 4-20)	
MENU	DESCRIPTION
	Indicates the printer has been removed from the online status. Is in a condition that allows menu changes.
	Is a display screen of the printer's current LCD brightness level. By pressing the left or right arrow keys of the printer's operator panel, the brightness of the LCD decrease or increases respectively.
	Indicates the printer is in a status for print operation. While in this state, most operational adjustments may not be performed.
	Is an informational menu screen that displays when the printer's internal buffer has been cleared of content.
	Is an informational menu screen that displays that the printer is in the process of resetting. This menu screen will disappear when the reset process is complete.
	Is an informational menu screen that displays that a particular key is currently locked so that change may not be performed. Pressing the appropriate keys will unlock the locked key so that it may be changed. Pressing the down arrow and the ENTER keys simultaneously will alter is condition.
	Is an informational menu screen that displays that a particular key has been unlocked so that change may not be performed. Pressing the appropriate keys will relock the unlocked key so that it may not be changed. Pressing the down arrow and the ENTER keys simultaneously will alter is condition.

5

TROUBLESHOOTING

- **Error Signal Troubleshooting**
- **Troubleshooting Table**
- **Interface Troubleshooting**
- **Test Print Troubleshooting**

ERROR SIGNAL TROUBLESHOOTING

ERROR SIGNALS		
DISPLAY	EXPLANATION	SOLUTION
<div style="border: 1px solid black; padding: 5px;"> B10 ERROR: NO DRAM DETECTED Cycle Power </div>	The printer could not find any DRAM.	Power off the printer for 15 seconds, then power on again. If the problem persists, contact an authorized customer service representative.
<div style="border: 1px solid black; padding: 5px;"> B11 ERROR: RAM TEST FAILED Cycle Power </div>	The printer found a defective memory location.	Power off the printer for 15 seconds, then power on again. If the problem persists, contact an authorized customer service representative.
<div style="border: 1px solid black; padding: 5px;"> B12 ERROR: PROGRAM MISSING Repeat Download </div>	The printer cannot the data controller program or the validation checksum is corrupt.	Power off the printer for 15 seconds, then power on again. If the problem persists, contact an authorized customer service representative.
<div style="border: 1px solid black; padding: 5px;"> B22 ERROR: DECOMPRESS SIZE Repeat Download </div>	Problem when downloading.	Cycle power. If the problem persists, repeat download.
<div style="border: 1px solid black; padding: 5px;"> B23 ERROR: DECOMPRESS CKSUM Repeat Download </div>	Problem when downloading.	Cycle power. If the problem persists, repeat download.
<div style="border: 1px solid black; padding: 5px;"> CALIBRATION FAIL See User Manual </div>	Calibration values derived from Manual Calibrate were not acceptable.	Perform a Run Manual Cal (run manual calibration) again.
<div style="border: 1px solid black; padding: 5px;"> DOWNLOADER ERROR BEYOND 8MB EFC Repeat Download </div>	Printer contains an 8MB EFC and the firmware attempted to access beyond its limit.	Contact an authorized service representative.
<div style="border: 1px solid black; padding: 5px;"> DOWNLOADER ERROR BEYOND 16MB EFC Repeat Download </div>	Printer contains an 16MB EFC and the firmware attempted to access beyond its limit.	Contact an authorized service representative.

ERROR SIGNALS		
DISPLAY	EXPLANATION	SOLUTION
<div style="border: 1px solid black; padding: 5px;"> DOWNLOADER ERROR BEYOND 32MB EFC Repeat Download </div>	Printer contains an 32MB EFC and the firmware attempted to access beyond its limit.	Contact an authorized service representative.
<div style="border: 1px solid black; padding: 5px;"> DOWNLOADER ERROR BEYOND 64MB EFC Repeat Download </div>	Printer contains an 64MB EFC and the firmware attempted to access beyond its limit.	Contact an authorized service representative.
<div style="border: 1px solid black; padding: 5px;"> DOWNLOADER ERROR EXTERNAL FLASH IS FULL Optimize Files </div>	An attempt was made to download to a full EFC.	Delete and optimize files.
<div style="border: 1px solid black; padding: 5px;"> DOWNLOADER ERROR EXTERNAL FLASH WAS NOT FOUND Insert Cartridge </div>	An attempt was made to download to a non-existent EFC.	Insert cartridge and repeat the process.
<div style="border: 1px solid black; padding: 5px;"> DOWNLOADER ERROR FLASH NOT ERASED Repeat Download </div>	The printer encountered an error trying to program flash memory.	Power off the printer for 15 seconds, then power on again. If the problem persists, contact an authorized customer service representative.
<div style="border: 1px solid black; padding: 5px;"> DOWNLOADER ERROR FLASH WRITE #1 Repeat Download </div>	A Flash Write failed to complete.	Try downloading again or contact an authorized customer service representative.
<div style="border: 1px solid black; padding: 5px;"> DOWNLOADER ERROR FLASH WRITE #2 Repeat Download </div>	A Flash Write failed to complete.	Try downloading again or contact an authorized customer service representative.
<div style="border: 1px solid black; padding: 5px;"> DOWNLOADER ERROR FLASH WRITE #3 Repeat Download </div>	A Flash Write failed to complete.	Try downloading again or contact an authorized customer service representative.

ERROR SIGNALS		
DISPLAY	EXPLANATION	SOLUTION
<div style="border: 1px solid black; padding: 5px; width: fit-content;"> DOWNLOADER ERROR FLASH WRITE #4 Repeat Download </div>	A Flash Write failed to complete.	Try downloading again or contact an authorized customer service representative.
<div style="border: 1px solid black; padding: 5px; width: fit-content;"> DOWNLOADER ERROR FLASH W ADDR BAD Repeat Download </div>	An attempt was made to write to flash where it wasn't present.	Try downloading again or contact an authorized customer service representative.
<div style="border: 1px solid black; padding: 5px; width: fit-content;"> DOWNLOADER ERROR MAIN FLASH IS FULL Optimize Files </div>	An attempt was made to download to a full main flash memory.	Delete and optimize files.
<div style="border: 1px solid black; padding: 5px; width: fit-content;"> DOWNLOADER ERROR NO EFC DETECTED Repeat Download </div>	The printer's firmware attempted to access an EFC that wasn't present.	Contact an authorized customer service representative.
<div style="border: 1px solid black; padding: 5px; width: fit-content;"> EC SOFTWARE FAIL Cycle Power </div>	Engine control software failure.	Power off the printer for 15 seconds, then power on again. If the problem persists, contact an authorized customer service representative.
<div style="border: 1px solid black; padding: 5px; width: fit-content;"> ERROR: INSUFFICIENT DRAM Cycle Power </div>	Not enough RAM memory available for the printer to function.	Power of the printer for 15 seconds, then power on again. If the message reappears, increase the Glob Mem Adjust size in the PRINTER SETUP menu and reboot the printer. If the message reappears, replace the main circuit board. Write down the message and return it with the defective board.
<div style="border: 1px solid black; padding: 5px; width: fit-content;"> ERROR: INSUFFICIENT FLASH Cycle Power </div>	The printer requires more flash memory to download program.	Power off the printer for 15 seconds, then power on again. If the problem persists, contact an authorized customer service representative.
<div style="border: 1px solid black; padding: 5px; width: fit-content;"> ERROR: WRONG CHECKSUM Repeat Download </div>	The printer received the complete program but the checksum did not match. The data may have been corrupted during download.	Power off the printer for 15 seconds, then power on again. If the problem persists, contact an authorized customer service representative.

ERROR SIGNALS		
DISPLAY	EXPLANATION	SOLUTION
<div style="border: 1px solid black; padding: 5px; width: fit-content;"> <p>ERROR: OCCURRED: CLEARING QUEUES</p> <p>Please Wait</p> </div>	<p>An interim message displays while the printer discards host data it cannot use because a fault condition exists.</p> <p>While the message displays, the asterisk (*) rotates.</p>	<p>Wait. When the asterisk (*) stops rotating, a different fault message will appear.</p> <p>Troubleshoot the final message.</p>
<div style="border: 1px solid black; padding: 5px; width: fit-content;"> <p>FILE SYS WRITE</p> <p>Check Flash</p> </div>	<p>Problem writing to flash memory.</p>	<p>Power off the printer for 15 seconds, then power on again. If the problem persists, contact an authorized customer service representative.</p>
<div style="border: 1px solid black; padding: 5px; width: fit-content;"> <p>GAP NOT DETECTED</p> <p>Check Sensor and Calibrate</p> </div>	<p>The printer is set for Gap or Mark sensing, but black mark is not being detected.</p>	<p>Ensure the Gap/Mark Sensor setting in the SENSOR SETUP menu matches the installed media.</p> <p>Ensure the sensors are properly positioned.</p> <p>Clean the sensor assembly and paper path.</p> <p>Run Auto-Cal to improve the sensor's ability to detect the media in use.</p> <p>Run the Media Profile printout in the SENSOR SETUP menu.</p> <p>Run Manual Calibrate.</p> <p>Manually change the Gap/Mark Thresh and/or Paper Out Thresh values.</p>
<div style="border: 1px solid black; padding: 5px; width: fit-content;"> <p>INVALID FILE SYS</p> <p>Optimize&Reboot</p> </div>	<p>File system not detected or flash was corrupted.</p>	<p>Enter the PRINTER SETUP menu and use the Optimize & Reboot option.</p>
<div style="border: 1px solid black; padding: 5px; width: fit-content;"> <p>LABEL MISSING</p> <p>Check Media Path</p> </div>	<p>The Label Taken Sensor did not detect the label present over the tear bar with Tear-Off or Peel-Off Media Handling mode enabled.</p> <p>The label was removed before the printer stopped printing or before the LCD "Remove Label" message displayed.</p> <p>The label slipped behind the platen roller.</p> <p>The label wrapped around the platen roller.</p> <p>Tear-Off or Peel-Off Media Handling mode was mistakenly selected.</p>	<p>Press the Pause key to continue printing and then wait for the LCD "Remove Label" message before removing the label.</p> <p>Open the pivoting deck, reinstall the label, close the print head, press the Pause key, and continue printing.</p> <p>Open the pivoting deck and remove wrapped labels from the platen. Clean all adhesive from the platen. Reinstall labels, close deck, press the Pause key, and continue printing.</p> <p>Select the correct Media Handling mode in the MEDIA Setup menu.</p>
<div style="border: 1px solid black; padding: 5px; width: fit-content;"> <p>LABEL READY</p> <p>Remove Label</p> </div>	<p>A label was detected at the front of the printer by the Label Taken Sensor. This is the normal reminder message when Peel-Off or Tear-Off Media Handling has been selected.</p> <p>A label was removed, but the "remove Label" message remained.</p> <p>The incorrect Media Handling mode was selected.</p>	<p>Remove the label from the front of the printer to allow the next label to print.</p> <p>Verify that a front door assembly is installed on the printer and that it is properly closed. Also ensure that debris is not obstructing the door mirror or the Label Taken Sensor.</p> <p>In the MEDIA SETUP menu, change Media Handling to the correct selection.</p>

ERROR SIGNALS		
DISPLAY	EXPLANATION	SOLUTION
<div style="border: 1px solid black; padding: 5px; width: fit-content;"> <p>MEDIA OUT Load Media</p> </div>	<p>Media was not installed or has run out. A break in media has occurred. Media was not correctly routed or installed. Media sensor is not correctly positioned. Media is correctly installed, but the sensor is not detecting it. Gap/Mark Thresh value may be set too high and/or Paper Out Thresh may be set too low.</p>	<p>Install media. If a break has occurred, reinstall the media. Press the Pause key to clear the fault message. Verify the media sensor is properly positioned. Run Auto-Cal to improve the ability of the sensor to detect the installed media. Check if the Gap/Mark Thresh is too high or the Paper Out Thresh is too low. Adjust the values as necessary. If using media without gaps or eye-marks, perform Run Auto-Cal to establish a valid Paper Out Thresh.</p>
<div style="border: 1px solid black; padding: 5px; width: fit-content;"> <p>MEDIA OUT COMPATIBLE WITH CUTTER Check Media Mode</p> </div>	<p>Tear-Off or Peel-Off Media Handling selection was attempted with the cutter option still installed. These modes require that the front door assembly be installed to use the Label Taken Sensor.</p>	<p>Select a different Media Handling mode.</p>
<div style="border: 1px solid black; padding: 5px; width: fit-content;"> <p>OPTION NOT INSTALLED</p> </div>	<p>If the printer is powered on with the cutter enabled in the Media Handling menu, but the cutter itself is open (in the down position, or the cutter upper enclosure is removed) the printer cannot detect the cutter. When using the cutter, the printer must be powered on with the cutter in the up position and the cutter upper enclosure installed.</p>	<p>Ensure the cutter option is installed, connected in the up position and the upper enclosure installed before powering on the printer. Install the cutter option or change to the correct Media Handling option in the MEDIA SETUP menu. If the error persists, contact an authorized customer service representative.</p>
<div style="border: 1px solid black; padding: 5px; width: fit-content;"> <p>PRINthead HOT Wait 5 Minutes Go Online</p> </div>	<p>The print head has become overheated.</p>	<p>Allow the print head to cool down for 5 minutes, then press the Pause key. Resume printing. If possible, reduce print intensity. If the problem persists, contact an authorized customer service representative.</p>
<div style="border: 1px solid black; padding: 5px; width: fit-content;"> <p>PRINthead POWER FAIL Cal For Service</p> </div>	<p>Print head lost power.</p>	<p>Replace the print head. Power off the printer for 15 seconds, then power on again. If the problem persists, contact an authorized customer service representative.</p>
<div style="border: 1px solid black; padding: 5px; width: fit-content;"> <p>PROGRAM IS NOT COMPATIBLE WITH THIS PRINTER Repeat Download</p> </div>	<p>An attempt was made to download a non-compatible program file.</p>	<p>Try downloading again. If the problem persists, contact an authorized customer service representative.</p>
<div style="border: 1px solid black; padding: 5px; width: fit-content;"> <p>RIBBON OUT Load Ribbon</p> </div>	<p>Ribbon is broken between the ribbon rewind spindle and the print head. Ribbon supply is empty.</p>	<p>Reattach ribbon. Load printer with new ribbon.</p>

ERROR SIGNALS		
DISPLAY	EXPLANATION	SOLUTION
<div style="border: 1px solid black; padding: 5px; width: fit-content;"> RFID TAG FAILURE Check Media </div>	Failed tag. Error displays in STOP mode causing the printer to halt.	Initiate reprint of the label from the host. When the error is cleared, the label with the failed tag moves forward to the next top-of-form position.
<div style="border: 1px solid black; padding: 5px; width: fit-content;"> RFID TAG MAX RETRY Check Media </div>	Failed tag. Error displays in OVERSTRIKE mode. Each failed label prints with the overstrike pattern and the form retries until the label retry count is exhausted.	Clear the error. When the error is cleared, the label with the failed tag moves forward such that the next label is in position.
<div style="border: 1px solid black; padding: 5px; width: fit-content;"> SERIAL BUFFER OVERFLOW </div>	Host sent data after the printer buffer was full (serial interface).	Make a configuration printout. Verify the printer matches the host serial interface configuration settings for Data Protocol, Baud Rate, Data Bits, Stop Bits, Parity, Data Terminal Ready, and Request To Send. Set printer serial interface parameters to match those of the host.
<div style="border: 1px solid black; padding: 5px; width: fit-content;"> SERIAL BUFFER OVERRUN </div>	Receive overrun (serial interface).	Make a configuration printout. Verify the printer matches the host serial interface configuration settings for Data Protocol, Baud Rate, Data Bits, Stop Bits, Parity, Data Terminal Ready, and Request To Send. Set printer serial interface parameters to match those of the host.
<div style="border: 1px solid black; padding: 5px; width: fit-content;"> SERIAL FRAMING ERROR </div>	Serial framing error over a serial interface.	Match the serial interface settings of the printer to those of the host computer.
<div style="border: 1px solid black; padding: 5px; width: fit-content;"> SERIAL PARITY ERROR </div>	Parity error (serial interface).	Ensure the printer's serial interface parameter settings match those of the host. Change as required to match.
<div style="border: 1px solid black; padding: 5px; width: fit-content;"> SOFTWARE ERROR Cycle Power </div>	Application software tried to perform an illegal power function. There are damaged logic circuits on the main circuit board.	Cycle the printer's power. If possible, print a job that has previously worked. If the problem persists, contact an authorized customer service representative.

TROUBLESHOOTING TABLE

TROUBLESHOOTING TABLE	
IMAGE VOIDS	
Dirty print head.	Clean print head.
Damaged print head.	Replace print head.
Damaged electronics.	Replace circuit board.
Damaged or worn roller.	Replace rollers.
Poor label quality.	Use higher quality media.
Ribbon stock and media are mismatched.	Consult with media supplier.
RIBBON WRINKLING	
Poor head alignment.	Adjust head balance and alignment.
Excessive temperature setting	Adjust temperature.
Poor ribbon tension.	Adjust tension as required.
Worn roller.	Replace as necessary.
Foreign material on print head and/or rollers.	Clean as required.
Foreign material on labels.	Use higher quality media.
Damaged print head.	Replace print head as required.
LIGHT PRINT IMAGES	
Low print head energy/darkness.	Adjust darkness level.
Low print head pressure.	Adjust head pressure and/or balance.
Foreign material on print head.	Clean print head and rollers.
Improper head alignment.	Align print head as required.
Excessive print speed.	Reduce print speed setting.
UNEVEN PRINT DARKNESS	
Unbalanced print head.	Adjust head balance.
Worn rollers.	Replace rollers as required.
Dirty print head.	Clean print head.
MEANDERING MEDIA	
Incorrectly loaded media.	Ensure correct loading.
Improperly adjusted media guides.	Adjust as required.
Unbalanced print head.	Adjust as required.
Worn rollers.	Replace as required.
NO LABEL MOVEMENT	
Loose or broken timing belt.	Replace or adjust as required.
Incorrect label sensor selected.	Check printer configuration for proper sensor selection.
No voltage output.	Replace fuse. Test power supply and replace as required.
Drive motor not operating.	Ensure wiring harness connection. Replace as necessary.
LCD FIELD ILLUMINATED BUT WITHOUT WORDS OR NO DISPLAY AT ALL	
Power supply issues.	Ensure cable properly connected. Check/replace power supply.
Incorrectly positioned display potentiometer.	Adjust as required.

Unit 5: Troubleshooting

NO PRINTED IMAGE	
Print head is disconnected.	Ensure print head wiring harness is connected on each end.
No voltage output.	Replace fuse. Test power supply and replace as required.
Defective print head.	Replace print head and reset counter.
Damaged electronics.	Replace circuit board.
Interface problems.	Troubleshoot interface - refer to the next chapter.
Data input error.	Ensure correct data stream.
PRINTER CREATES A BLANK LABEL.	
Data input error.	Ensure correct data stream.
Incorrect label sensor selection.	Ensure correct printer configuration.
Disconnected print head.	Power off the printer and ensure a proper connection.
Defective print head.	Replace print head as required.
Defective main circuit board.	Replace main board as required.
INCORRECT LABEL POSITIONING.	
Incorrect label sensor selection.	Ensure correct printer configuration.
Improper sensor adjustment.	Adjust sensor sensitivity as required.
Data input error.	Ensure correct data stream.
Incorrect offset settings.	Adjust settings as required.
Incorrect applicator setup.	Refer to applicator documentation or contact manufacturer.
SMEARED PRINT IMAGES	
Poor media quality.	Use higher quality media.
Foreign material on print head and platen roller.	Clean print head and rollers.
Foreign material on labels.	Use higher quality media.
Excessive print head energy.	Adjust darkness setting.
Excessive print speed.	Adjust print speed as required.

INTERFACE TROUBLESHOOTING

This chapter provides a checklist for the various interface types. Locate the checklist relative to the interface used and perform each of the troubleshooting tasks until the problem has been isolated.

PARALLEL INTERFACE	
CHK	TROUBLESHOOTING STEP
	Ensure the interface module is correctly installed. Run self-test to verify.
	Ensure the printer cable is connected to the appropriate LPT port on the host computer. If using a Windows printer driver, ensure the correct port is selected.
	Ensure a IEEE1284 printer cable is being used.
	Ensure the host's peripheral settings are set to ECP for faster throughput. Refer to the computer manufacturer's documentation for details.
	Ensure the printer is receiving information from the computer using the Receive Buffer Hex Dump mode. Refer to that procedure within this manual for instructions. The command stream should be continuous and possess 0Dhex and/or 0Ahex (carriage return and line feed) characters throughout. However, there should not be either located between the start (<ESC>A and the stop (<ESC>Z) commands.
	Try another port to isolate the problem.
	Replace the main circuit board if determined to be the problem.

RS232 SERIAL INTERFACE	
CHK	TROUBLESHOOTING STEP
	Ensure the correct interface module is correctly installed. Run self-test to verify.
	Ensure the serial cable (Null Modem) meets specifications and is correctly connected at each end.
	Ensure the serial cable is not defective.
	Ensure the communication parameters for the baud rate, parity, data bits and stop bits are consistent with those being sent from the host computer.
	Ensure the printer is receiving information from the computer using the Receive Buffer Hex Dump mode. Refer to that procedure within this manual for instructions. The command stream should be continuous and possess 0Dhex and/or 0Ahex (carriage return and line feed) characters throughout. However, there should not be either located between the start (<ESC>A and the stop (<ESC>Z) commands.
	Try another port to isolate the problem.
	Replace the main circuit board if determined to be the problem.

UNIVERSAL SERIAL BUS (USB) INTERFACE	
If nothing prints during a test print, verify the device drivers have been successively installed by performing the following:	
CHK	TROUBLESHOOTING STEP
	Click on Start, Settings, and then Control Panel.
	Click on System within the new window.
	Click on the Device Manager tab.
	Ensure that the View Device By Type is checked.
	Scroll to SATO-USB Device and ensure that errors do not exist. Reinstall as required.
	Reboot the PC and the printer.

LAN ETHERNET INTERFACE	
CHK	TROUBLESHOOTING STEP
	Ensure the interface has been correctly configured. Wait two minutes and run self-test to verify. If a test label does not print, there may be a hardware problem.
	Ensure the cable and its ports are not defective.
	Ensure that a faulty print server or other protocol related scenarios are not creating a queue setup issue. Systematically perform checks and tests to isolate the cause.
	If using TCP/IP, ensure a valid IP address is specified and that all parameters are correct (subnet mask, gateway, etc.). Attempt to PING the IP address assigned to the network interface.
	If using a repeater or hub, ensure the SQE is turned off. Also ensure the repeater port is not defective by trying the print server on another port.
	Install the IPX/SPX protocol on a workstation to determine if the network device can be discovered via the MAC address. If able, configure the appropriate protocols and retest connectivity.
	Use a crossover cable to isolate the printer from the network by connecting from the interface and workstation. Verify that the parameters match on each. Test connectivity.

802.11G WIRELESS INTERFACE	
CHK	TROUBLESHOOTING STEP
	Ensure the antenna is properly and completely installed.
	Ensure the wireless card is properly installed.
	Ensure the green connection lights on the back of the interface board are illuminated.
	If not obtaining an IP address, check the SSID or encryption and ensure those were properly entered.
	To determine the IP address obtained through the DHCP wireless device, power off the printer, place switch 3 in the upward position on the wireless card and reinsert it into the printer, and power the printer on. Wait approximately 30 seconds for a print out of configurations.

CENTRONICS INTERFACE	
CHK	TROUBLESHOOTING STEP
	Ensure the interface module is correctly installed. Run self-test to verify.
	Ensure the printer cable is connected to the appropriate LPT port on the host computer. If using a Windows printer driver, ensure the correct port is selected.
	Ensure the host's peripheral settings are set for Centronics output for faster throughput. Refer to the computer manufacturer's documentation for details.
	Ensure the printer is receiving information from the computer using the Receive Buffer Hex Dump mode. Refer to that procedure within this manual for instructions. The command stream should be continuous and possess 0D Hex and/or 0A Hex (carriage return and line feed) characters throughout. However, there should not be either located between the start (<ESC>A and the stop (<ESC>Z) commands.
	Replace the main circuit board with another to isolate the problem.

TEST PRINT TROUBLESHOOTING

Chapter provides instruction on special printing to identify and resolve specific print problems.

HEX DUMP

Allows the operator to determine if there were problems in the downloading of data. The contents of the print buffer can be examined using the Hex Dump Mode. In the left column, each line of data received is numbered. The center column provides the data in hexadecimal format. And in the right column, same data is provided in the ASC II format. Follow the flow chart provided below to perform this activity.

TEST LABEL PRINTING

Allows the operator to identify specific problems regarding mechanical performance and setup. The test label is designed to assist in the identification of print problems. Follow the flow chart provided below to perform this activity.

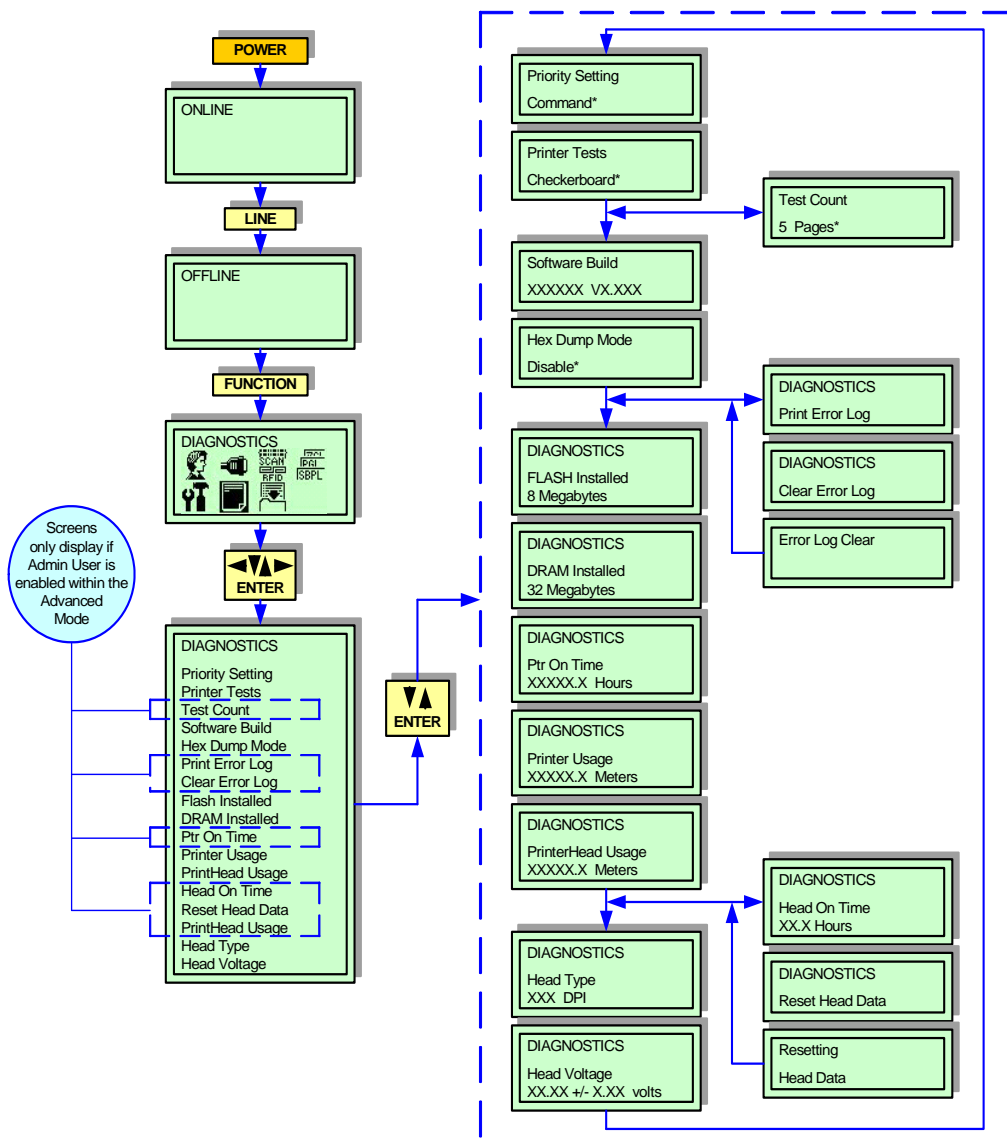

Figure 6-1, Diagnostics Mode

Unit 5: Troubleshooting

NOTE: The only print problem that the following sample test label does not display is fading of print image from one side of the label to the other. This is the result of improper print head balance.



Figure 6-2, Sample Test Label

6

MAINTENANCE

- **Cleaning Procedures**
- **Replacement Procedures**
- **Adjustment Procedures**

CLEANING PROCEDURES

Cleaning of the printer is a necessary maintenance activity to ensure print quality and longer printer life. There are two basic types of cleaning involved; the removal of loose debris and the removal of residue.

Use a soft cloth and/or a pneumatic blower to remove debris from the printer. This process should be performed prior to the removal of residue. To remove residue, apply SATO Solvent or isopropyl alcohol to a clean cotton swab and gently wipe the entire surface of the print head and platen roller clean.

WARNING: DISCONNECT POWER SUPPLY TO THE PRINTER AND ALLOW TO COOL TO ROOM TEMPERATURE PRIOR TO CLEANING. EXERCISE CARE WHEN CLEANING TO PREVENT PERSONAL INJURY.

CAUTION: IF USING A PNEUMATIC BLOWER TO REMOVE DEBRIS FROM THE PRINTER, EXERCISE CARE TO PREVENT PRINT HEAD DAMAGE.

REPLACEMENT PROCEDURES

This chapter provides in-depth instruction on all primary component and assembly replacement, in addition to most secondary components. Use the text in conjunction with their accompanied graphics to ensure complete comprehension throughout the process. Especially observe all cautionary or warning notations.

CAUTION: STATIC ELECTRICITY CAN RESULT IN COMPONENT DAMAGE. OBSERVE APPROPRIATE GROUNDING PROCEDURES WHEN REPLACING ANY COMPONENTS.

PRINT HEAD REPLACEMENT

If the print head becomes damaged or worn, it can be easily removed and replaced without having to make critical adjustments. Before replacing the print head, check the head counter values by printing a test pattern. Instructions relating to the Head Counter may be found in the Configuration unit of this manual.

To replace the print head, press inward on the release lever, retract and disconnect the damaged print head, connect the printer's wiring harnesses to the replacement print head, and insert upward into the upper print assembly. The properly installed print head will snap into position.

CAUTION: EXERCISE CARE WHEN INSTALLING THE PRINT HEAD TO ENSURE THAT ITS ELEMENTS ARE NOT DAMAGED DURING INSTALLATION.

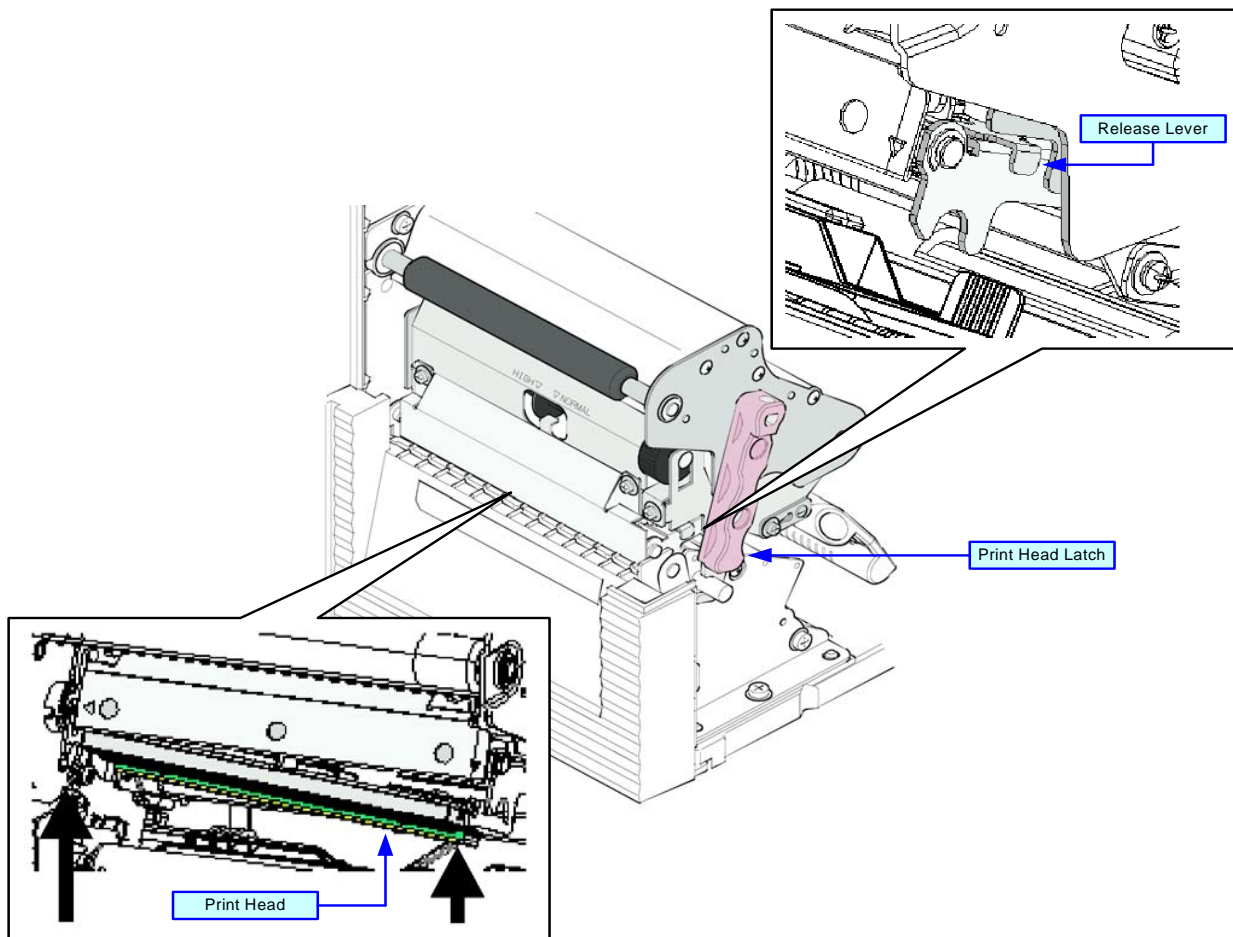

Figure 6-1, Print Head Replacement

FUSE REPLACEMENT

The fuse is wired to the power receptacle and protects the printer from power surges from the electrical source. If a surge of electricity reaches the fuse, its filament will melt creating a disruption of the flow. In order to bridge the gap so the printer may again be functional, the damaged fuse must be replaced.

To replace the fuse, unscrew the fuse cap from the fuse cylinder, remove the damaged fuse from the cap, and insert the replacement fuse in its place. Screw the fuse cap back into the fuse cylinder along with the replacement fuse.

NOTE: The orientation of the fuse does not matter. It only has to be installed into its respective cylinder and be able to make contact on each end to function.

NOTE: Fuse amperage and voltage rating may be found stamped into the fuse's metal contacts or labeled on the printer's rear.

CAUTION: IMPROPER FUSE USAGE MAY RESULT IN DESTROYED ELECTRICAL COMPONENTS AND/OR FIRE. ENSURE THE DAMAGED FUSE IS REPLACED WITH ONE OF IDENTICAL PHYSICAL DIMENSIONS AND AMPERAGE. TO DO THIS, DUPLICATE THE INFORMATION STAMPED ON THE FUSE'S METAL CASING.

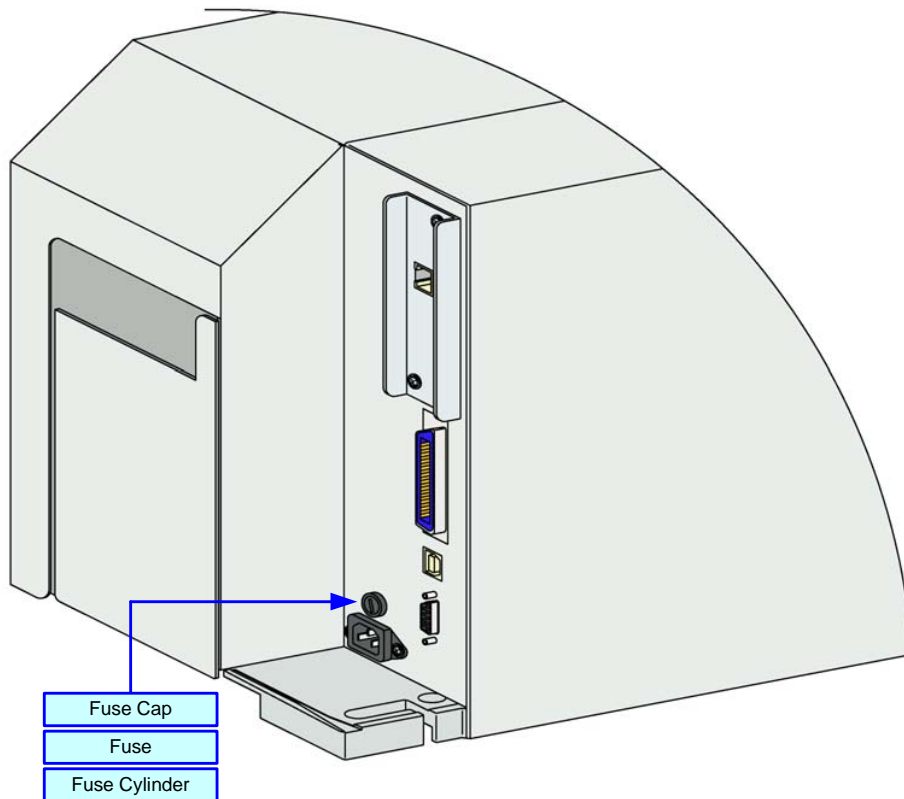

Figure 6-2, Fuse Replacement

MEDIA PLATEN ROLLER REPLACEMENT

The media platen roller is considered to be a high-wear component due to constant treading of the print media against its contact surface. This constant contact will eventually wear grooves into the rubber material and negatively affect print output.

To replace the platen roller, loosen the securing the retaining bracket to the lower print assembly, then withdraw the bushing from the end of the platen roller assembly. Withdraw the worn platen roller assembly from the printer and insert its replacement in its place.

Insert the bushing onto the end of the platen roller assembly, reposition the retaining bracket over the bushing, and retighten the screw.

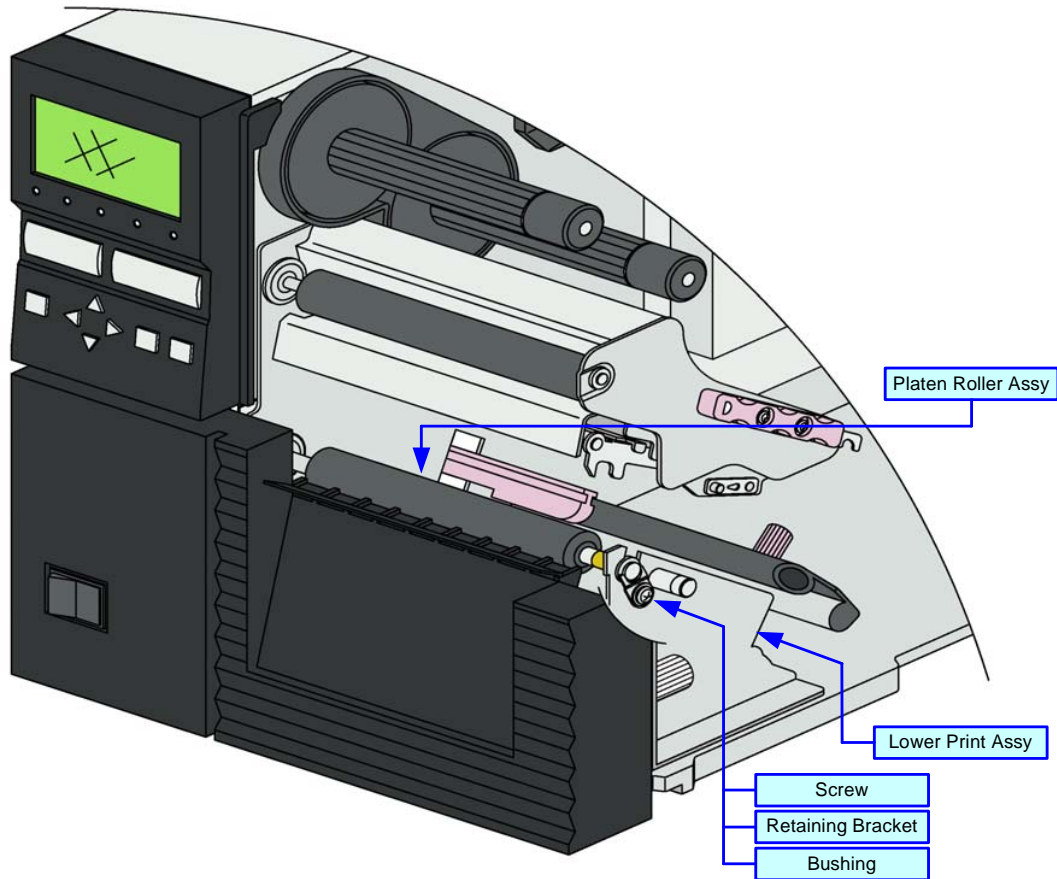

Figure 6-3, Media Platen Roller Replacement

ADJUSTMENT PROCEDURES

This chapter covers all of the printer and printer accessory adjustments. These adjustments include mechanical adjustments required following the replacement of components and assemblies, in addition to, the operational adjustments required following a job change.

LABEL SENSOR POSITIONING

The label sensor assembly provides a mounting apparatus for the eye-mark, gap, and paper-end sensors. Position adjustment of the label sensor is not required when using standard label media.

When non-standard media is used, place a section of the media on the media ramp oriented as if loaded for printing. Manually grasp the sensor assembly and move it laterally so that the sensor indicators embossed in its side are aligned with the reference marks on the media.

- 1 Open the right housing cover to access print assembly.
- 2 Find label sensor adjustment handle (Figure 6-4) located between the upper and lower print assemblies.
- 3 Manually move the adjustment handle to the left or right as required to properly position the label sensor.

NOTE: There are two markers on the front face of the media stabilizer. The marker closest to the printer's center frame references the location of the eye-mark sensor, the one furthest out references the gap sensor. Adjust according to the type of media to be used.

NOTE: Sensor positioning may also be achieved by measuring from the printer's center frame outward to the specified distance for sensor/reference mark alignment. Refer to Figure 9-3 in the Appendix unit of this manual for applicable dimensions.

- 4 Test print a label to determine if the label sensor is properly aligned.

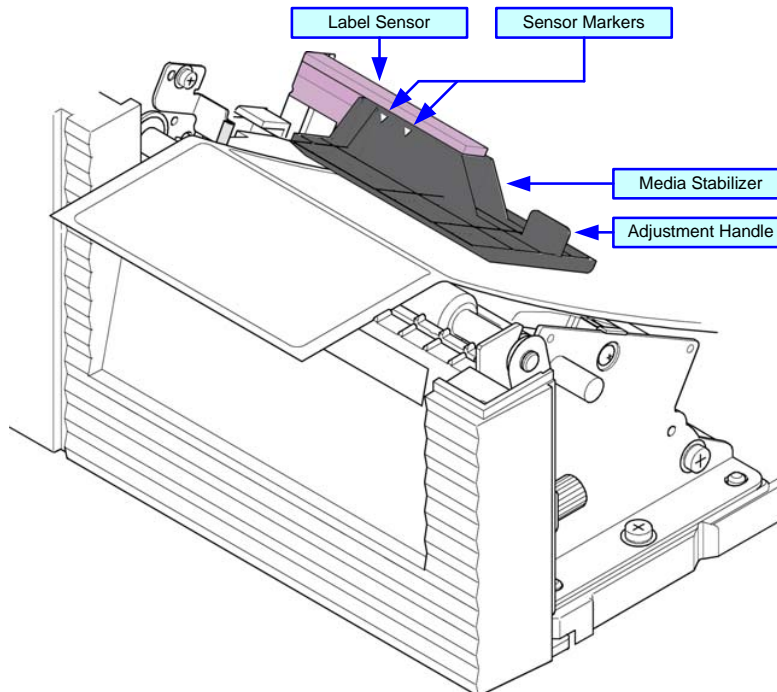

Figure 6-4, Label Sensor Positioning

PRINT HEAD BALANCE ADJUSTMENT

Print head balance is the equalization of pressure against the platen roller from one end to the opposite. If the print head balance is out of adjustment, the printed image will be darker on one side of the label than the other and the media will be prone to travel in the direction of least resistance.

To adjust balance, a scaled dial allows adjustment based on the width of the media used. The setting may be viewed through the dial window of the upper print assembly. The table that follows correlates paper width with a dial setting.

NOTE: Once the balance has been set, the print head pressure must also be set. Refer to the Print Head Pressure chapter of this manual for instructions.

NOTE: If a desired setting cannot be achieved through the dial alone, loosen the set screw, adjust the plate, retighten the set screw, and then readjust the dial.

BALANCE ADJUSTMENT					
Paper Width (millimeters)	25 to 55		55 to 85		80 to 110
Dial Setting	1	2	3	4	5

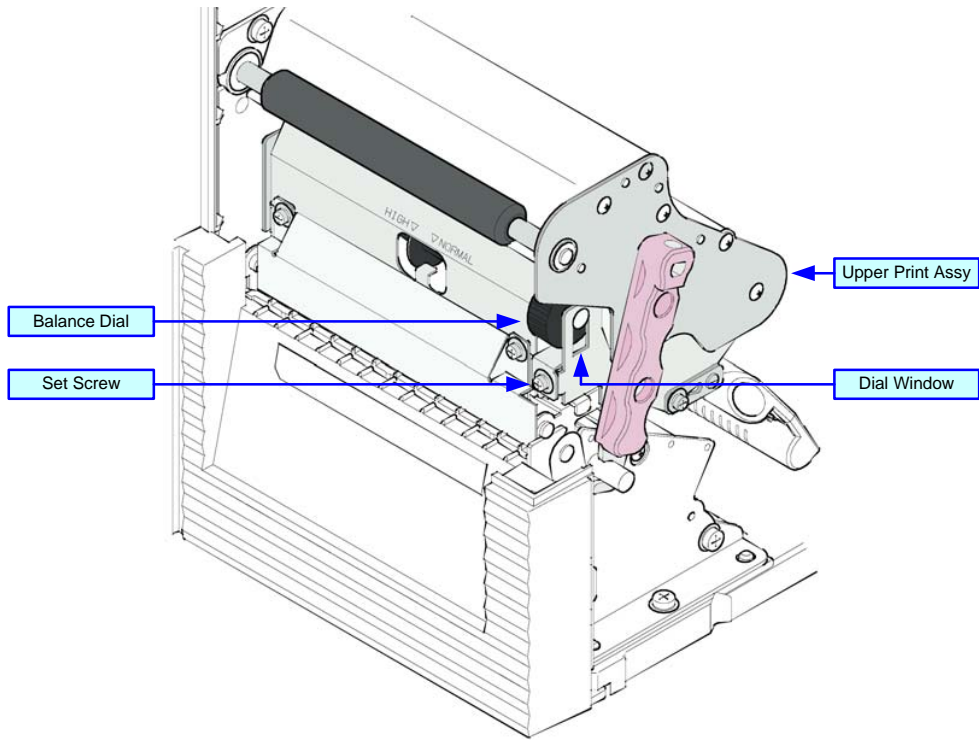

Figure 6-5, Print Head Balance Adjustment

PRINT HEAD PRESSURE

Print Head Pressure allows for the print head to be adjusted to accommodate different media types (thicknesses). The pressure setting lever is two position (normal and high). The table that follows correlates the media used with a pressure setting.

To adjust the pressure lever, the balance dial must be set to the "A" position. Once the pressure is properly set, return the balance dial to its previous position.

BALANCE ADJUSTMENT		
MEDIA	SCALE	THICKNESS
Thin paper, normal label, etc.	Normal	0.080 to 0.200
Thick paper, tag stock, etc.	High	0.200 to 0.268

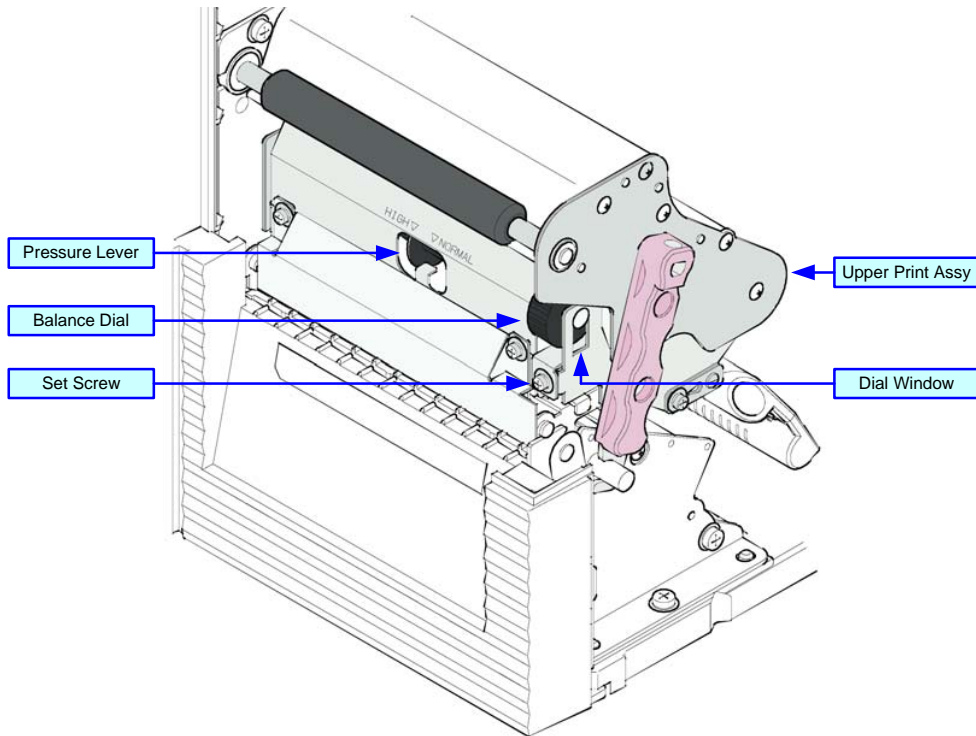

Figure 6-6, Print Head Pressure

PRINT HEAD ALIGNMENT

Print head position has a direct impact on print quality. The print head must be parallel with the platen roller for the printed image to be consistent across the label. By turning the alignment dial upward or downward, that end of the print head is advanced forward or backward respectively.

To adjust the alignment, open the print head, turn the alignment dial, and print a test label. Repeat that process until remedy is achieved.

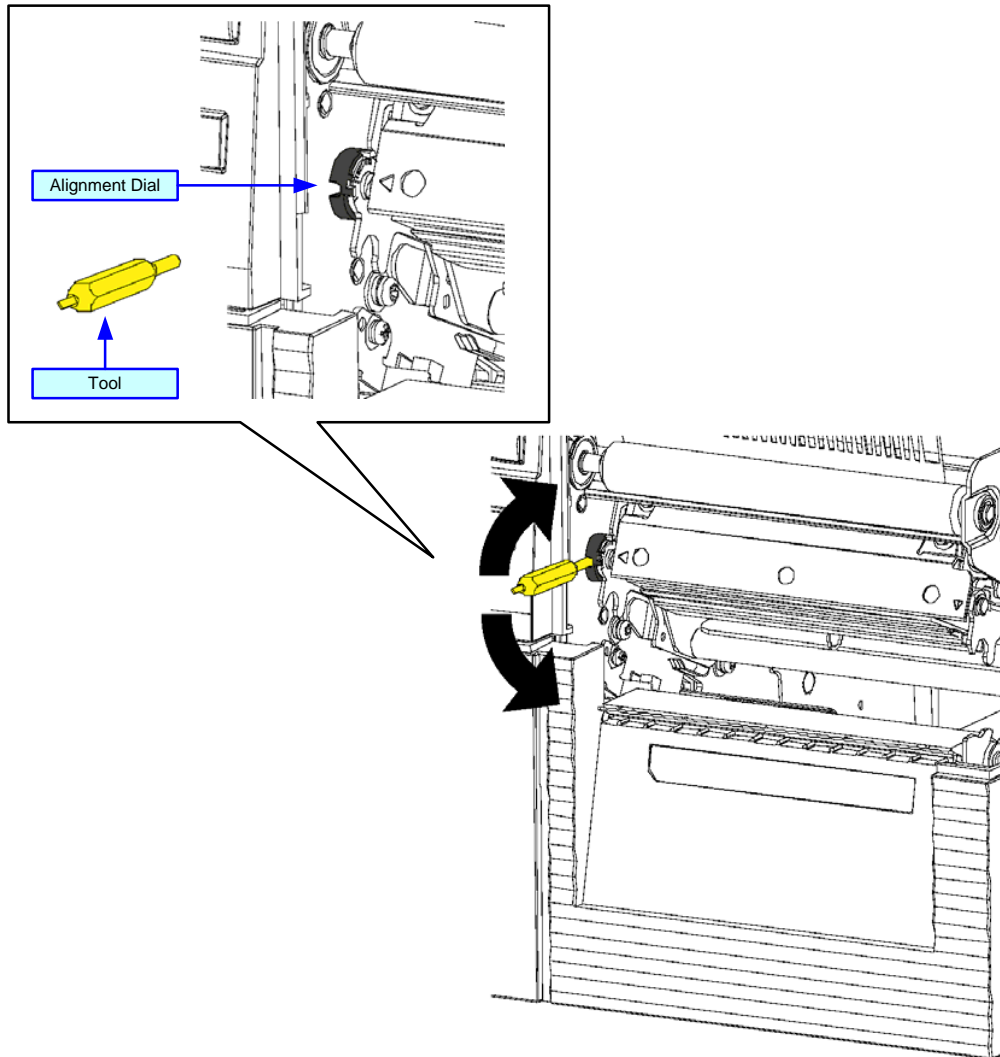

Figure 6-7, Print Head Alignment

RIBBON GUIDE ALIGNMENT

If the print ribbon is not spread smoothly over the print head when it makes contact with the media, print voids will occur at the point of the ribbon fold. Typically, this is the result of the axis of one of the following not being perfectly parallel: ribbon spindle, print head, ribbon roller, or ribbon guide.

The purpose of the adjustable ribbon guide is to compensate for the axis deviations of the other three. By adjusting the ribbon guide proportionally to the degree of deviation, the ribbon spreads smoothly as it travels from the ribbon supply spindle, over the ribbon roller, to the guide and beyond.

Ribbon guide adjustment is a trial and error activity that requires the pause of printing, unlatching of the print head, adjusting the guide, relatching the print head, and printing once again. Several labels must be printed following each adjustment to determine if the adjustment was effective.

The ribbon guide is secured to the face of the print assembly by a screw on each end. Before adjusting the guide, visually inspect that its axis is parallel with that of the print assembly. If not, adjust accordingly, ensure the set screws are secure, and once again commence printing. By starting in a neutral position, either end may be adjusted vertically as necessary to remedy the wrinkling problem.

NOTE: To facilitate viewing of pertinent components, Figure 6-8 does not show ribbon and media loaded. When performing this adjustment activity, both must be loaded.

NOTE: Refer to their relative procedures within this manual for guidance on Print Head Balance and Print Head Alignment.

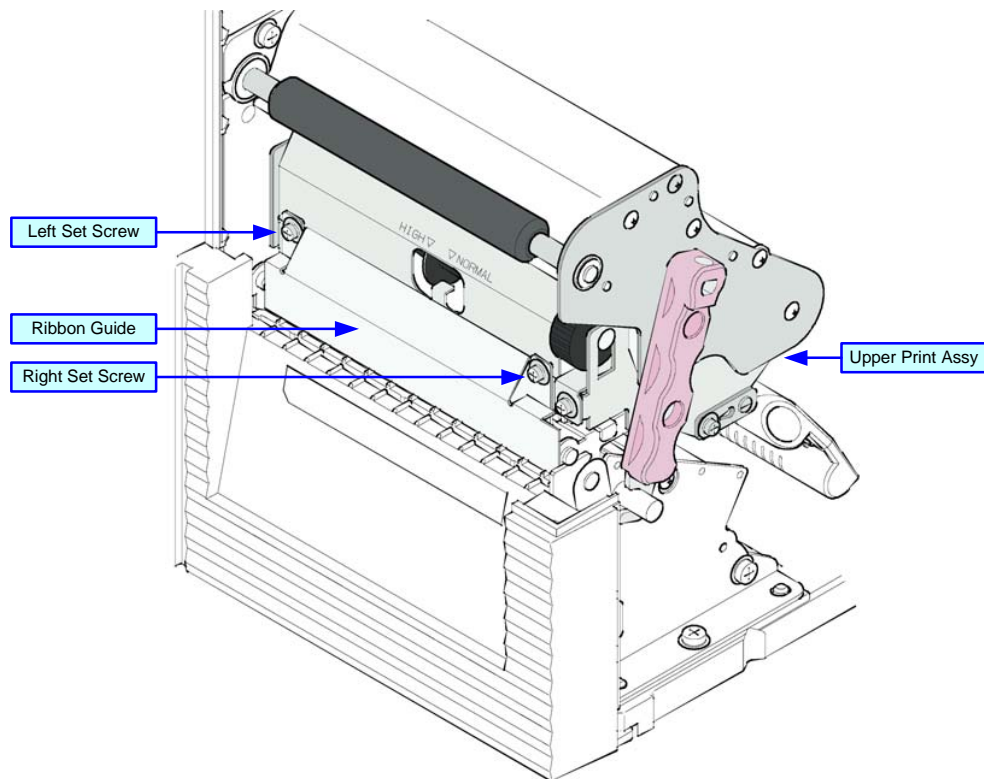

Figure 6-8, Ribbon Guide Alignment

RIBBON ROLLER ALIGNMENT

If the print ribbon is not spread smoothly over the print head when it makes contact with the media, print voids will occur at the point of the ribbon fold. Typically, this is the result of the axis of one of the following not being perfectly parallel: ribbon spindle, print head, ribbon roller, or ribbon guide.

The purpose of the adjustable ribbon roller is to compensate for the axis deviations of the other three. By adjusting the ribbon roller proportionally to the degree of deviation, the ribbon spreads smoothly as it travels from the ribbon supply spindle, to the guide, and beyond.

ATTENTION: The ribbon roller should not require adjustment. Therefore, attempt to correct ribbon wrinkling through the other methods and adjust this as a last resort.

Ribbon roller adjustment is a trial and error activity that requires the pause of printing, unlatching of the print head, adjusting the guide, relatching the print head, and printing once again. Several labels must be printed following each adjustment to determine if the adjustment was effective.

The ribbon roller is secured to the side of the upper print assembly and that's where the roller adjustment plate is located. Loosen its set screw, adjust the plate as perceived necessary, then retighten its set screw.

NOTE: To facilitate viewing of pertinent components, Figure 6-9 does not show ribbon and media loaded. When performing this adjustment activity, both must be loaded.

NOTE: Refer to their relative procedures within this manual for guidance on Print Head Balance , Print Head Pressure, and Ribbon Guide Alignment.

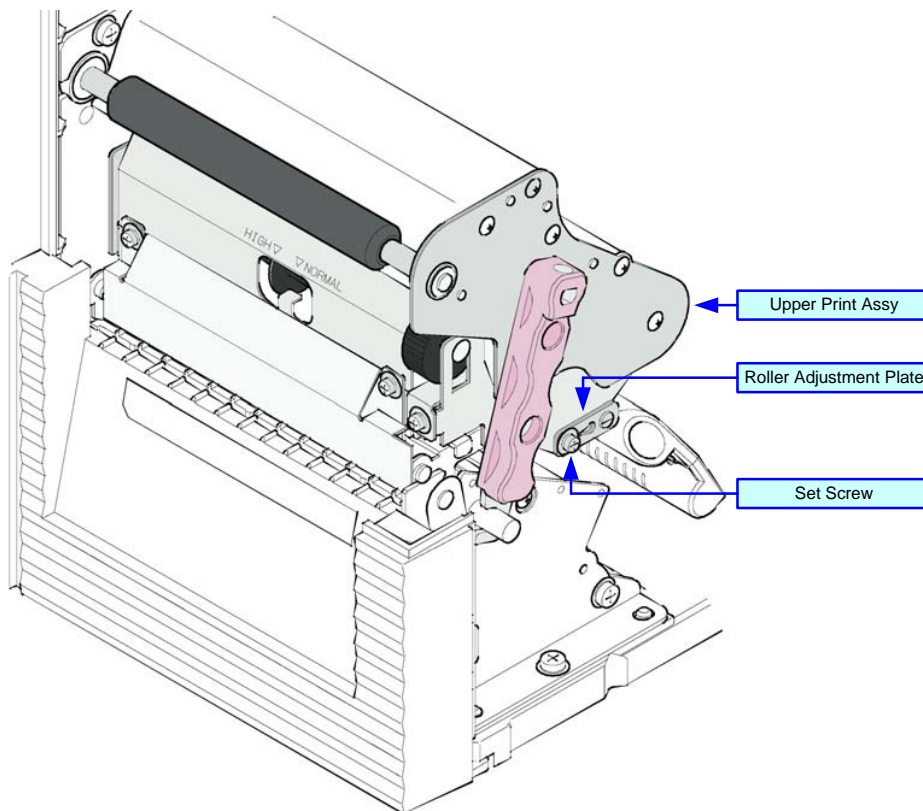

Figure 6-9, Ribbon Roller Alignment