



KOAXIALE STECKVERBINDER COAXIAL CONNECTORS







Einleitung
Preface 4

Koaxiale Steckverbinder Serie 1,6-5,6
Coaxial Connectors Type 1.6-5.6 8

Koaxiale Steckverbinder Serie BNC
Coaxial Connectors Type BNC 12

Koaxiale Steckverbinder Serie TNC
Coaxial Connectors Type TNC 18

Koaxiale Steckverbinder Serie N
Coaxial Connectors Type N 24

Koaxiale Steckverbinder Serie 4,1-9,5
Coaxial Connectors Type 4.1-9.5 46

Koaxiale Steckverbinder Serie 7-16
Coaxial Connectors Type 7-16 50

Kabelabfangungen
Cable Entries 77

Übergangsverbinder
Inter-type adaptors 78

Werkzeuge und Zubehör
Tools and Accessories 85

Index 88

VSWR Umrechnungstabelle
VSWR Conversion table 91

*Steckverbinder, die nicht in diesem Katalog aufgeführt sind, bitten wir in jedem Fall bei uns anzufragen.
Oft lassen sich durch Verwendung von Sonderausführungen in der Gerätekonstruktion elegante Lösungen,
bei gleichzeitiger Einsparung von Kosten, erzielen!
Send us an enquiry for any connectors that are not listed in this catalogue.
Often special unit designs can help achieve elegant solutions and cost savings at the same time!*

**Dieser Katalog ist auch als pdf Datei auf CD-ROM bei uns erhältlich.
This catalogue is also available as pdf file on CD-ROM.**

GENERAL TECHNICAL INFORMATION

Das QM-System der SPINNER GmbH ist gemäß DIN EN ISO 9001 aufgebaut und zertifiziert.

Die Umwelt zu schützen ist uns Verpflichtung und Herausforderung zugleich. Sorgfältige Auswahl der Werkstoffe und Verfahren, aber auch die partnerschaftliche Zusammenarbeit mit umweltbewussten Lieferanten, werden ergänzt durch ein zukunftsweisendes Entsorgungssystem.

Die SPINNER GmbH gehört in ihrer Branche zu den Ersten, die den Umweltschutz als Firmenphilosophie integriert haben und dementsprechend früh nach DIN EN ISO 14001 zertifiziert wurde.

Die Reduzierung von Gefahrstoffen, z.B. der Ersatz von lösungshaltigen Gewindgleitmitteln durch lösemittelfreie Produkte, gehört genauso zu unseren Verpflichtungen wie Energieeinsparungen im Produktions- und Verwaltungsbereich. Aus diesem Grund werden wir Ihr Unternehmen in den Bemühungen umweltgerechte Produkte zu produzieren und zu vertreiben voll unterstützen.

Dies beinhaltet selbstverständlich auch die volle Einhaltung der RoHS – Forderungen (RL 2002 / 95 / EG) mit den derzeit geltenden Ausnahmeregelungen für unseren Produktbereich entsprechend Artikel 4, Absatz 1.

VSWR / Reflexionsfaktor

Wenn eine elektrische Leitung mit ihrem Wellenwiderstand abgeschlossen ist, dann wird ein darauf übertragenes Signal vollständig am Abschlusswiderstand absorbiert. Weicht die Impedanz des Abschlusses jedoch vom Wellenwiderstand der Leitung ab, so kommt es zu einer mehr oder weniger starken Reflexion der Welle.

Der Reflexionsfaktor r ist über die Beziehung:

$$r = \frac{Z - Z_0}{Z + Z_0}$$

mit dem komplexen Wellenwiderstand der Leitung Z_0 und dem komplexen Abschlusswiderstand Z verbunden. Die auf der Leitung vorlaufenden und reflektierten Wellen überlagern sich dabei zu stehenden Wellen. Das Amplitudenverhältnis der größten und kleinsten Spannung auf einer verlustlosen Leitung ist als Stehwellen-Verhältnis oder VSWR (Voltage Standing Wave Ratio) definiert:

$$\text{VSWR} = \frac{1 + |r|}{1 - |r|}$$

Der Reflexionsfaktor wird oft auch im logarithmischen Maß der Rückflussdämpfung α angegeben:

$$\alpha = -20 \log(r) \text{ dB}$$

(siehe Umrechnungstabelle Seite 91)

The QA system of SPINNER GmbH is designed and certified under DIN EN ISO 9001.

For us environmental protection is a commitment and a challenge at the same time. We select all materials and processes carefully, co-operate with environmentally minded suppliers in partnership, and we maintain a waste management system.

SPINNER GmbH has been one of the first companies in the industry to integrate environmental protection into the company philosophy, and accordingly we were certified under DIN EN ISO 14001 very early.

We are committed to reduce the use of hazardous materials, so we replace solvent-based thread lubricants by solvent-free products, and we strive to save energy in production and administration. Thus we fully support your intention to manufacture and sell environmentally friendly products.

Of course this also includes full compliance with the RoHS requirements (Directive 2002 / 95 / EC) with the currently applicable exclusion for our product area acc. to Article 4, para. 1.

VSWR / reflection factor

When an electrical line is terminated by a load with its characteristic impedance a signal transmitted to the line is fully absorbed by the matching load. However, if the impedance of the termination differs from the characteristic impedance of the line the wave will be reflected more or less strongly. The reflection factor r is related to the complex impedance of the line, Z_0 , and the complex terminating impedance, Z :

$$r = \frac{Z - Z_0}{Z + Z_0}$$

The waves continuing along the line and reflected waves are overlaying to form standing waves. The amplitude relationship between the largest and the smallest voltage on a loss-free line is defined as the VSWR (Voltage Standing Wave Ratio):

$$\text{VSWR} = \frac{1 + |r|}{1 - |r|}$$

The reflection factor is often specified as the logarithmic value of the return loss:

$$\alpha = -20 \log(r) \text{ dB}$$

(cf. conversion table on page 91)

GENERAL TECHNICAL INFORMATION

Steckverbinder der Qualitätsstufe 2 genügen den allgemeinen Anforderungen, die in den einschlägigen Normen nicht näher spezifiziert sind. Der Reflexionsfaktor von SPINNER-Steckern wird dennoch stichprobenweise überprüft. Für Steckverbinder der Stufe 1 werden grundsätzlich maximale Reflexionsfaktoren in bestimmten Frequenzbereichen garantiert, wie zwischen Kunden und Hersteller vereinbart. Die Qualitätsstufe 0 beschreibt Steckverbinder in Messqualität mit geringst möglichen Reflexionsfaktoren. In den Steckernormen werden die Anschlussmaßtoleranzen der Steckverbinder der Stufe 0 genau vorgeschrieben.

Der Reflexionsfaktor unserer Steckverbinder ist in der Regel wesentlich geringer als in den einschlägigen Normen spezifiziert.

Detaillierte Angaben sind in der Beschreibung der jeweiligen Steckverbinder enthalten.

Intermodulation

Werden über eine Leitung gleichzeitig mehrere Trägerfrequenzkanäle geführt, entstehen durch nichtlineare Kennlinien von Bauteilen im Signalpfad Störsignale in Form von Mischprodukten.

Die Entstehung dieser neuen, unerwünschten Signale wird Intermodulationsprodukt (IM-Produkt) genannt. Die Frequenz der IM-Signale errechnet sich aus den verwendeten Trägerfrequenzen über folgende Formel:

$$f_{IMx} = af_1 \pm bf_2 \pm \dots \pm mf_z$$

Zur Messung der IM-Güte eines passiven HF-Bauteils werden 2 Signale mit festgelegtem gleichem Leistungspegel und den Frequenzen f_1 und f_2 in den Prüfling eingespeist.

Die IM-Signale der Ordnung 2 (IM2: $f_1 \pm f_2$), Ordnung 3 (IM3: $2f_1 \pm f_2$) oder höherer Ordnung können dann mit einem Empfänger gemessen werden.

Obwohl moderne Mobilfunksysteme durch die Wahl der Sende- bzw. Empfangsfrequenzbereiche eine Störung durch die betragsgrößten IM-Signale (IM2) ausschließen, kann das Auftreten von IM-Produkten höherer Ordnung (IM3, IM5, IM7,...) in Nutzbändern nicht vermieden werden.

In den meisten Fällen stellen deshalb die IM-Signale der dritten Ordnung den „worst case“ Zustand dar und werden daher als Maß für die IM-Güte eines HF-Bauteils verwendet.

Die beeinflussenden Faktoren der IM-Verzerrung im Fall passiver HF-Bauelemente sind die verwendeten Werkstoffe, intermetallische Kontakte, Kontaktkräfte, Kontaktflächen, Korrosion, Oxidschichten oder Schmutz.

Die Höhe eines gemessenen IM-Produkts ist darüber hinaus abhängig von Vibration, Bewegung oder anderen Umwelteinflüssen. Außerdem treten Langzeitveränderungen durch mechanische Beanspruchung, Temperatur- oder Klimaschwankungen auf.

Connectors of quality grade 2 meet the general requirements. They are not specified in greater detail in the applicable standards. Nevertheless SPINNER does random sample tests of the connectors' reflection factor.

For quality grade 1 connectors the maximum reflection factors in certain frequency ranges are always guaranteed as agreed between customer and manufacturer. Quality grade 0 includes connectors of measurement application quality with the lowest possible reflection factors. The connector standards define the connection's dimensional tolerance for quality grade 0 connectors exactly. As a rule the reflection factor of our connectors is far lower than the one specified by the applicable standards.

For more detailed information refer to the description of the individual connector types.

Intermodulation

If several carrier frequency channels are fed through a single line at the same time the non-linear parameters of components in the signal path create mixed products, i. e. noise signals.

The emergence of these new undesirable products is called the intermodulation product. The frequency of such IM signals can be calculated from the carrier frequencies using the following formula:

$$f_{IMx} = af_1 \pm bf_2 \pm \dots \pm mf_z$$

The IM quality of passive RF components is measured by feeding two signals with a defined identical power level at frequencies f_1 and f_2 into the test component. Then a receiver is used to measure the second order (IM2: $f_1 \pm f_2$), third order (IM3: $2f_1 \pm f_2$) or higher order IM signals.

Modern mobile communication systems select the transmission and reception frequency range properly to rule out interference from the strongest IM signals (IM2). However, the occurrence of higher order IM products (IM3, IM5, IM7,...) in the used bands cannot be prevented.

So in most cases the third order IM products represent the „worst case“, which is used to measure the IM quality of RF components.

The factors influencing IM distortion in passive RF components are the materials employed, intermetal contact, contact forces, contact areas, corrosion, oxide layers, or dirt. The strength of the measured IM product further depends on vibration, movement and other environmental influences. In addition long-term changes may occur due to mechanical load and temperature or climate fluctuation.

GENERAL TECHNICAL INFORMATION

Einsatzfrequenzbereich und Anschlussleistung

Neben den mit der Frequenz ansteigenden Reflexionen wird die Anwendung eines koaxialen Stecksystems zu hohen Frequenzen hin durch das Auftreten höherer Ausbreitungsmoden begrenzt. In den meisten Fällen beschränkt aber das verwendete Kabel den Einsatz eines Steckverbinders, z.B. durch die maximale Einsatzfrequenz und Leistung.

Die übertragbare HF-Leistung wird bestimmt durch:

- Die maximal zulässige HF-Spitzenspannung: Mit dem Ansteigen der über einen koaxialen Steckverbinder übertragenen HF-Leistung steigt auch die Feldstärke innerhalb des Steckverbinders bis hin zum Erreichen der Durchschlagsspannung.
- Thermische Belastbarkeit: Bei Anstieg der übertragenen HF-Leistung steigt die Stromdichte am Innenleiter. Durch die Leitungsdämpfung entsteht Verlustwärme, die zur Zerstörung des Steckverbinders führen kann.

Alle Leistungsangaben in der folgenden Tabelle beziehen sich auf das angegebene Stecksystem bei +40 °C und einer Innenleitertemperatur von +120 °C.

Frequency range and power rating

In addition to reflections, which increase along with frequency, the occurrence of higher propagation modes limits the possibility of using a connector at higher frequencies. However, in most cases the cable that is used will limit the use of a connector, e. g. by the maximum frequency and power rating. The maximum transmittable RF power is determined by

- max. allowable RF peak voltage. When the RF power transmitted through a coaxial connector increases, the field strength within the connector also increases until the breakdown voltage is reached.
- thermal capability. When the transmitted RF power increases, the current density on the inner conductor increases as well. The attenuation loss generates waste heat that can cause destruction of the connector.

All power ratings in the table below refer to the specified connection system at +40 °C ambient temperature and an inner conductor temperature of +120 °C.

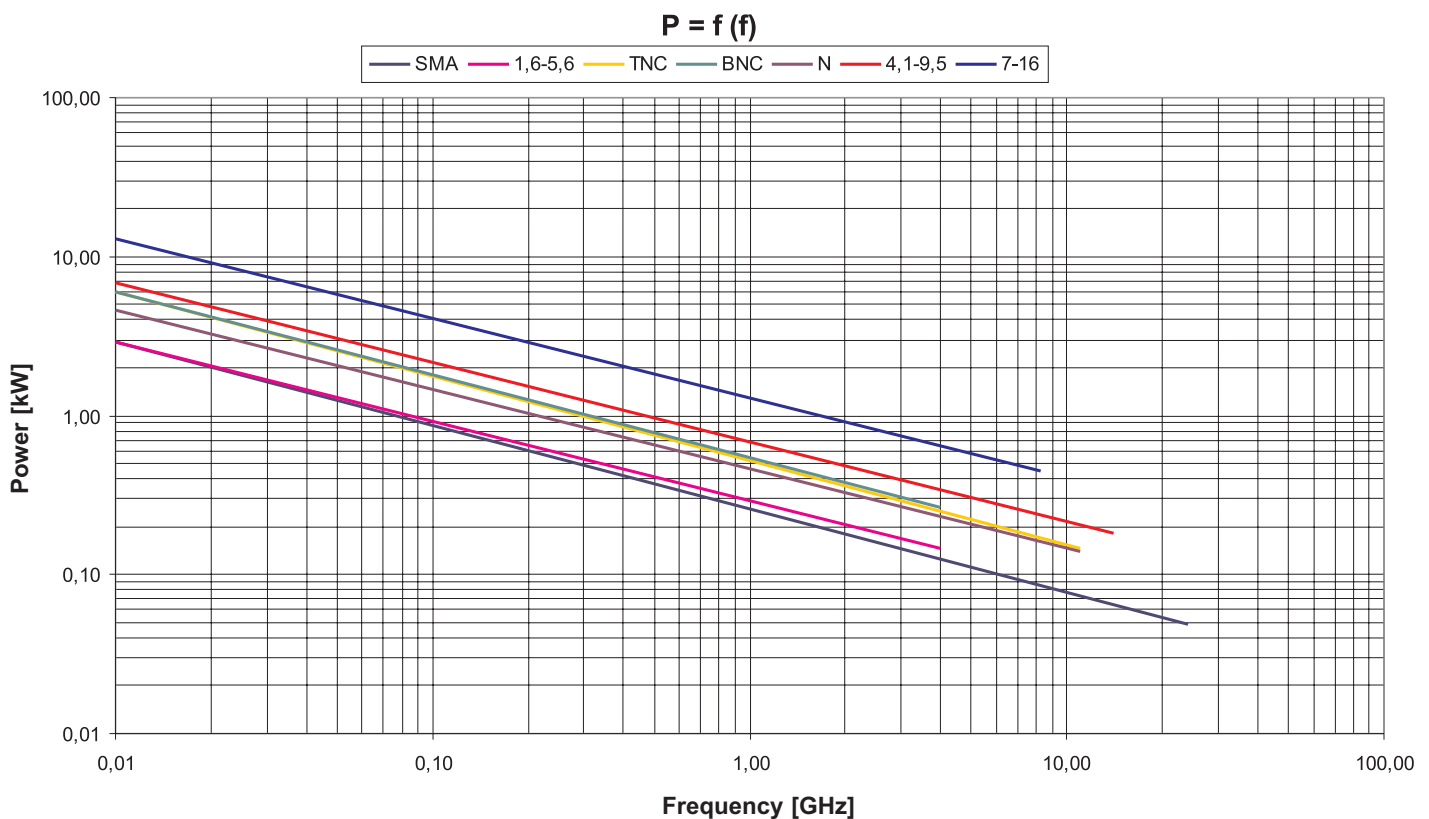

GENERAL TECHNICAL INFORMATION

Dichtungsmethoden und Definitionen

Steckverbindungen werden häufig unter harten klimatischen Bedingungen verwendet, die eine Abdichtung erforderlich machen. Steckverbindungen, die nach Norm „dicht“ sind und Kabelstecker für vollisolierte Kabel werden deshalb zum Kabel hin mit O-Ringen oder Profildichtungen abgedichtet. Bei Steckverbindern, die gemäß Norm nicht dicht sind (z.B. BNC), werden die Kabelbefestigungen nicht dicht ausgeführt.

Bei Steckverbindern für Kabel mit Kupfer-Wellrohr-Außenleiter (ausgenommen für Cellflex®-Kabel LCF14 und LCF38, sowie SCF14, SCF38, SCF12) wird in der Standardausführung zur Erzielung einer einwandfreien Abdichtung der Dichtungswerkstoff PLAST 2000® in den Hohlraum zwischen Kabelaußenleiter und Stecker eingespritzt. PLAST 2000® ist dauerelastisch und haftet ausgezeichnet an allen Metallteilen. Nähere Informationen sind in den entsprechenden Montageanweisungen enthalten.

Hinweis: PLAST 2000® ist nicht Teil des Lieferumfangs und muss gesondert bestellt werden.

In der Norm DIN EN 60529:1991 werden Begriffe für Schutzarten durch Gehäuse von elektrischen Betriebsmittel festgelegt. Um die Schutzgrade durch ein Gehäuse anzugeben wird der IP-Code benutzt z. B.:

IP 23 CH; IP = International Protection (Ingress Protection)

IP 2 3 C H

0-6 oder X – Gegen Eindringen von festen Fremdkörpern
0-6 or X – against ingress of solid objects

- 0 nicht geschützt/*no special protection*
- 1 $\geq 50,0$ mm \varnothing
- 2 $\geq 12,5$ mm \varnothing
- 3 $\geq 2,5$ mm \varnothing
- 4 $\geq 1,0$ mm \varnothing
- 5 staubgeschützt/*dust protection*
- 6 staubdicht/*dust tight*

X ersetzt die Kennziffer, falls keine Angabe notwendig/
X replaces numeral if not applicable

IP 2 3 C H

0-8 oder/or X – Gegen Eindringen von Wasser/*against ingress of water*

- 0 nicht geschützt/*no special protection*
- 1 senkrecht Tropfen/*vertically dripping*
- 2 Tropfen (15° Neigung)/*dripping (15° tilted)*
- 3 Sprühwasser/*spraying*
- 4 Spritzwasser/*splashing*
- 5 Strahlwasser/*jetting*
- 6 starkes Strahlwasser/*powerful jetting*
- 7 zeitweiliges Untertauchen/*temporary immersion*
- 8 dauerndes Untertauchen/*continous immersion*

X ersetzt die Kennziffer, falls keine Angabe notwendig/
X replaces numeral if not applicable

Sealing methods and definitions

Connectors are often used in harsh climate environments that require sealing. That is why connectors that are "tight" according to a standard and cable connectors for fully insulated cables have an O-ring or profile seal between connector and cable. On connectors that are not standardised as tight (e.g. BNC) the cable clamp is not sealed.

On connectors for cables with a corrugated copper outer conductor (except Cellflex® cables LCF14 and LCF38 as well as SCF14, SCF38, and SCF12) the standard design is perfectly sealed by injecting (sealing compound PLAST 2000®) into the void space between the cable outer conductor and the connector. PLAST 2000® is a long-term elastic compound with excellent adhesion to all metal parts. For more detailed information refer to the respective mounting instructions.

Note: PLAST 2000® is not included in the scope of delivery and needs to be ordered separately.

Standard DIN EN 60529:1991 defines the protection ratings for the housings of electrical appliances. The IP code is used for specifying the protection rating of a housing, e. g.:

IP 23 CH; IP = International Protection (Ingress Protection)

IP 2 3 C H

fakultativ – A,B,C,D – Gegen Zugang zu gefährlichen Teilen mit Fremdkörpern
optional – A,B,C,D – against access to hazardous parts

- A Handrücken/*back of hand*
- B Finger/*finger*
- C Werkzeug/tool
- D Draht/*wire*

IP 2 3 C H

fakultativ – H, M, S, W – Ergänzende Informationen speziell für/
optional – H, M, S, W – supplementary information specific for

- H Hochspannungsgeräte/*high voltage equipment*
- M Bewegung während Wasserprüfung/*motion during water test*
- S Stillstand während Wasserprüfung/*stationary during water test*
- W Wetterbedingungen/*weather conditions*

1.6 - 5.6

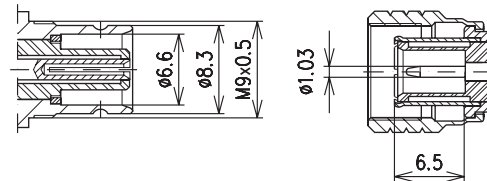

Die 75 Ω Steckverbinder 1,6-5,6 werden im Bereich digitaler Telekommunikations- und Datennetze zur Übertragung hoher Bitraten eingesetzt. Als Indoor-Steckverbinder kommen sie zur Verschaltung der 75 Ω Netzpunkte bei den Betreiber- und Teilnehmeranlagen zum Einsatz.

Bis zu einem Frequenzbereich von ca. 8 GHz einsetzbar, bietet die Steckverbindung eine sehr zuverlässige elektrische Verbindung bei hoher mechanischer Stabilität.

Sie ist mechanisch kuppelbar mit dem Steckanschluss 1,8-5,6 (50 Ω), jedoch sind die unterschiedlichen Impedanzen nicht kompensiert.

Eine stabile Befestigung der Überwurfmutter, die das spezielle SPINNER-Profil aufweist, wird durch Einrollen gewährleistet.

The 75 Ω connector series 1.6-5.6 are used in digital telecommunication and data networks for transmitting high bit rates. As indoor connectors they are used to connect the 75 Ω network nodes in operator and user systems.

The connection has an operating frequency range up to about 8 GHz and provides a most reliable electrical connection with high mechanical stability.

The connection can be mechanically coupled with connector series 1.8-5.6 (50 Ω), however the difference in impedance is not compensated.

The coupling nut with its special SPINNER profile is fastened reliably by flanging.

Die Bezeichnung des Stecksystems 1,6-5,6 ist, wie bei allen anderen metrischen Stecksystemen, abgeleitet aus den Abmessungen des Innen- und Außenleiters. Der Innenleiter hat einen nominalen Außendurchmesser von 1,6 mm und der Außenleiter einen nominalen Innendurchmesser von 5,6 mm.

The designation of the connection system 1.6-5.6 and of all other metric connection systems is derived from the dimensions of the inner and outer conductor. The inner conductor has a nominal outer diameter of 1.6 mm, and the outer conductor has a nominal inner diameter of 5.6 mm.



Elektrisch / Electrical	IEC 60169-13	IEC	SPINNER	Bemerkung / Remarks
Wellenwiderstand Characteristic impedance	10.2	75 Ω		
Frequenzbereich Frequency range	10.2	1 GHz		
VSWR	10.2	≤ 1.22		gerader Steckverbinder straight connector
		≤ 1.40		Winkel-Steckverbinder right angle connector
Innenleiter-Kontaktwiderstand Center contact resistance	10.2	≤ 4 mΩ		anfänglich initial
Außenleiter-Kontaktwiderstand Outer contact resistance	10.2	2 mΩ		anfänglich initial
Isolationswiderstand Insulation resistance	10.2	≥ 10 GΩ		anfänglich initial
Spannungsfestigkeit in Meereshöhe Proof voltage at sea level	10.2	1 kV		40...65 Hz
Arbeitsspannung in Meereshöhe Working voltage at sea level	10.2	400 V		40...65 Hz
Wirksamkeit der Abschirmung Screening effectiveness	10.2	≥ 100 dB		für Schraubverbindung with screw coupling

Mechanisch / Mechanical	IEC 60169-13	IEC	SPINNER	Bemerkung / Remarks
Kupplungsdrehmoment Coupling torque	10.2	0.3 Nm	0.5 Nm	für Schraubverbindung with screw coupling
Prüfdrehmoment Proof torque	10.2	1.0 Nm		für Schraubverbindung with screw coupling
Zugfestigkeit des Kupplungsmechanismus Tensile strength of coupling mechanism	10.2	300 N		für Schraubverbindung with screw coupling
Mechanische Lebensdauer Mechanical lifetime	10.2	500	5000	Betätigungen Operations
Fesselung des Innenleiters Center contact captivation				ja yes

Umwelt / Environmental	IEC 60169-13	IEC	SPINNER	Bemerkung / Remarks
Klimaklasse / Climatic category	10.2	55/155/21		
Temperaturbereich / Temperature range	10.2	-55...+155 °C		

Werkstoffe und Oberflächenbehandlung / Materials and Surface Finish				
Federnde Kontaktteile Resilient contact members	hochfeste Cu-Legierung, vergoldet high strength copper alloy, gold plated			
Isolation Insulation	PTFE/FEP			
Innen- und Außenleiterkontaktteile Center and outer conductor parts	Cu-Legierung, vergoldet Copper alloy, gold plated			
Sonstige Metallteile Other metal parts	Cu-Legierung, glanzvernickelt Copper alloy, bright nickel plated			

KABELSTECKVERBINDER ■ CABLE CONNECTORS

Kabelstecker – Straight cable plugs



BN 77 80 00

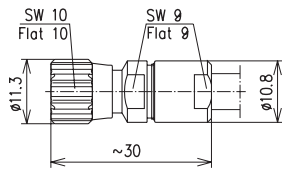

Kabel Typ Cable type	Ausführung Version	Bestell-Nr. Part-No.
0,5/3,0 2YC(mS)CY	geklemmt clamped	BN 77 80 00
RG 59 B/U (0,6/3,7)	geklemmt clamped	BN 88 03 00



BN 88 03 00

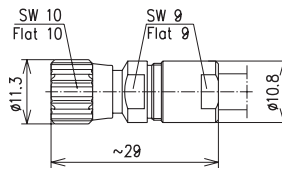

Kabelwinkelstecker – Right angle cable plug



BN 88 06 00

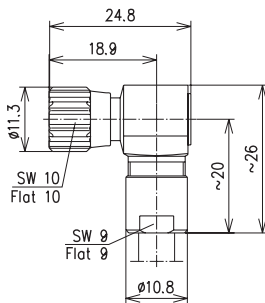

Kabel Typ Cable type	Ausführung Version	Bestell-Nr. Part-No.
RG 59 B/U (0,6/3,7)	geklemmt clamped	BN 88 06 00

Gehäusekuppler mit Winkelkabelanschluss – Fixed socket with right angle cable connection



BN 67 71 07

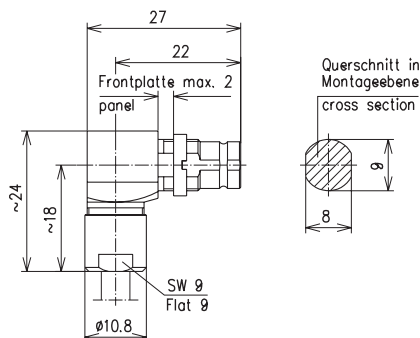

Kabel Typ Cable type	Ausführung Version	Bestell-Nr. Part-No.
0,5/3,0 2YC(mS)CY	geklemmt clamped	BN 67 71 07

KABELSTECKVERBINDER ■ CABLE CONNECTORS

Gehäusekuppler mit Winkelkabelanschluss – Fixed socket with right angle cable connection



BN 67 71 12

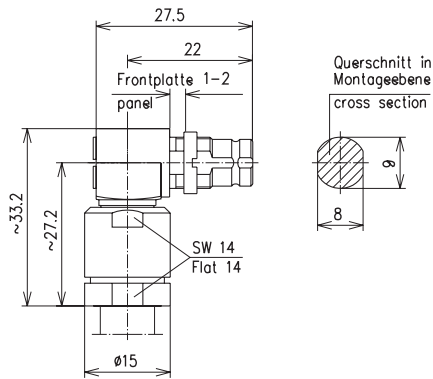

Kabel Typ Cable type	Ausführung Version	Bestell-Nr. Part-No.
1,0/6,5 2YCCY	geklemmt clamped	BN 67 71 12

ZWISCHENSTECKVERBINDER ■ WITHIN-TYPE ADAPTORS



BN 88 67 00

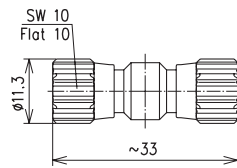

BN 88 67 00
Zwischenstecker
Adaptor, plug-plug



BN 88 68 00

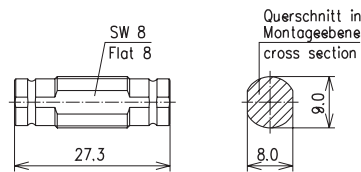

BN 88 68 00
Kupplung
Adaptor, socket-socket



BN 88 68 10

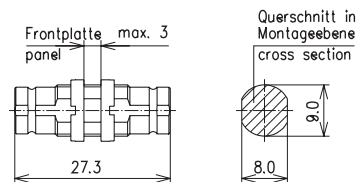

BN 88 68 10
Durchführungskupplung
für Einlochmontage
Fixed adaptor, socket-socket,
for single hole mounting



BN 67 36 05

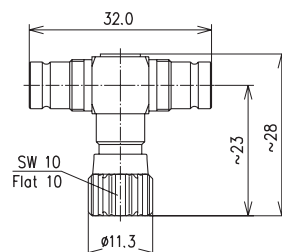

BN 67 36 05
T-Verzweigung,
Kuppler-Stecker-Kuppler
T-adaptor,
socket-plug-socket

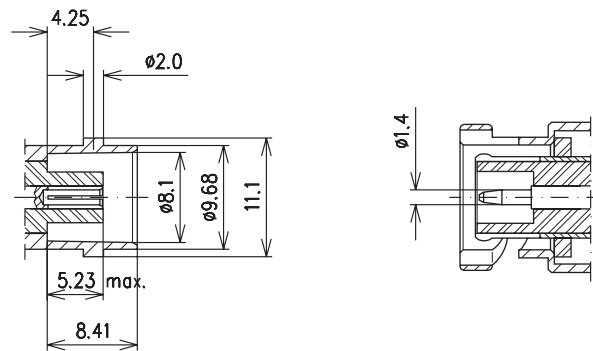

Die Steckverbindung BNC wird mit 50 Ω und 75 Ω Wellenwiderstand gefertigt und ist untereinander steckkompatibel. Die 50 Ω Ausführung kann für Frequenzen bis zu 10 GHz eingesetzt werden, optimale Übertragungseigenschaften werden bis 3 GHz erzielt.

Unsere BNC-Überwurfmutter besitzen das bekannte griffige SPINNER-Profil und eine mit Federn aus nicht rostendem Stahl abgestützte Bajonett-Hülse. Die Bajonett-Nut ist gefräst. Dadurch ist die Abnutzung selbst nach mehr als 10.000 Steckzyklen gering. Durch die Verwendung hochfester Kupferlegierungen für alle federnden Kontaktteile gewährleistet SPINNER eine erstklassige Kontaktierung.

Die Verbindung wird mit einer Viertel Umdrehung der Überwurfmutter hergestellt. Damit ist die Steckverbindung besonders geeignet für alle Anwendungen in PC-Netzwerken, Funk- und Videotechnik bzw. im Laborbereich, bei denen häufig und schnell Verbindungen hergestellt werden müssen.

Die BNC-Technik hat auch bei der Übertragung von schwachen Gleichströmen und niederfrequenten Wechselströmen eine große Bedeutung. In der Regel werden die Anschlüsse an Messgeräten wie Oszilloskop, Frequenzzähler oder Funktionsgenerator in BNC-Technik ausgeführt.

The BNC connectors are manufactured in versions with 50 Ω and 75 Ω of characteristic impedance, which are compatible with one another.

The 50 Ω version can be used for frequencies up to 10 GHz, with optimum transmission properties achieved up to 3 GHz.

Our BNC coupling nuts have the known SPINNER profile with good grip and a bayonet housing supported by stainless steel springs. The bayonet nut is a milled part, which keeps wear very low, even after more than 10,000 mating cycles. SPINNER uses high-strength copper alloys for all spring-loaded contact parts, thus ensuring superior contact performance.

The connection is closed by a quarter turn of the coupling nut. That makes the connection especially suitable for all applications in PC networks, wireless and video technology and in laboratories, i. e. wherever connections need to be made quickly and frequently. BNC technology is also widely used for transmitting low-power DC and low-frequency AC.

Usually connections to measuring devices such as oscilloscopes, frequency meters or function generators are made using BNC technology.

Die Deutung der Abkürzung BNC ist umstritten. Als Erklärungen werden häufig Bayonet Neill Concelman (benannt nach den Entwicklern Paul Neill und Carl Concelman), aber auch Bayonet Navy Connector, British Naval Connector oder Bayonet Nut Connector verwendet.

The meaning of the abbreviation BNC is sometimes discussed controversially. It is often explained as Bayonet Neill Concelman (named after the developers Paul Neill and Carl Concelman), but Bayonet Navy Connector, British Naval Connector or Bayonet Nut Connector are also used.

Elektrisch / Electrical	IEC 60169-8	IEC	SPINNER	Bemerkung / Remarks
Wellenwiderstand Characteristic impedance		50 Ω (75 Ω)		
Frequenzbereich Frequency range	3.	3 GHz (1 GHz)		
VSWR	9.3.2	≤ 1.22		gerader Steckverbinder straight connector
		≤ 1.30		Winkel-Steckverbinder right angle connector
Innenleiter-Kontaktwiderstand Center contact resistance	9.4.2	≤ 10 mΩ	≤ 1.5 mΩ	anfänglich initial
Außenleiter-Kontaktwiderstand Outer contact resistance	9.4.2	≤ 2.5 mΩ	≤ 1.0 mΩ	anfänglich initial
Isolationswiderstand Insulation resistance	9.1	≥ 5 GΩ		anfänglich initial
Spannungsfestigkeit in Meereshöhe Proof voltage at sea level	9.1	1.5 kV		50...60 Hz
Arbeitsspannung in Meereshöhe Working voltage at sea level	3.	500 V		50...60 Hz
Wirksamkeit der Abschirmung Screening effectiveness	9.8.2	≥ 100 dB		

Mechanisch / Mechanical	IEC 60169-8	IEC	SPINNER	Bemerkung / Remarks
Kupplungsdrehmoment Coupling torque	9.5	0.07...0.25 Nm		
Mechanische Lebensdauer Mechanical lifetime	9.5	500	10000	Betätigungen Operations
Fesselung des Innenleiters Center contact captivation				ja yes

Umwelt / Environmental	IEC 60169-8	IEC	SPINNER	Bemerkung / Remarks
Klimaklasse / Climatic category	4.	55/155/56		
Temperaturbereich / Temperature range	4.	-55...+155 °C		

Werkstoffe und Oberflächenbehandlung / Materials and Surface Finish				
Federnde Kontaktteile Resilient contact members	hochfeste Cu-Legierung, versilbert (MIL-Typen Innenleiter vergoldet) high strength copper alloy, silver plated (MIL-types center conductor gold plated)			
Isolation Insulation	PTFE/FEP			
Innen- und Außenleiterkontaktteile Center and outer conductor parts	Cu-Legierung, versilbert (MIL-Typen Innenleiter vergoldet) Copper alloy, silver plated (MIL-types center conductor gold plated)			
Sonstige Metallteile Other metal parts	Cu-Legierung, glanzvernickelt Copper alloy, bright nickel plated			
Dichtungen Gaskets	Silikonkautschuk Silicone rubber			

KABELSTECKVERBINDER ■ CABLE CONNECTORS

Kabelstecker – Straight cable plugs

BNC



BN 69 20 02

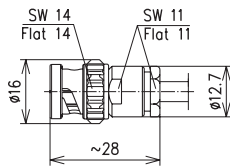

BN 69 12 50

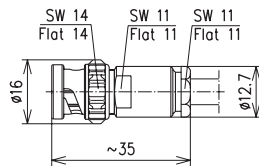

BN 73 90 01

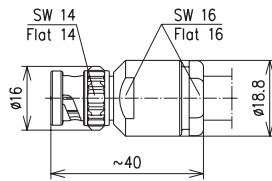

BN 88 60 50

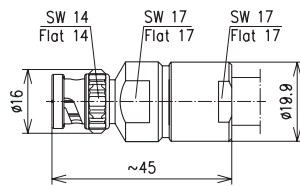

Kabel Typ Cable type	Ω	Ausführung Version	Bestell-Nr. Part-No.
RG 58 C/U RG 142 B/U RG 223/U RG 400/U	50	geklemmt clamped	BN 69 20 02
RG 62 A/U EPD 314 75A 0,5/3,0 2YC(mS)CY	75	geklemmt clamped	BN 69 12 50
RG 213/U RG 214/U	50	geklemmt clamped	BN 73 90 01
1,0/6,6 2YCCY	75	geklemmt clamped	BN 88 60 50

KABELSTECKVERBINDER ■ CABLE CONNECTORS

Kabelstecker – Straight cable plugs



BN 69 20 08

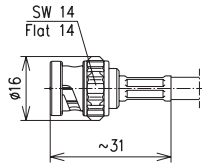

Kabel Typ Cable type	Ω	Ausführung Version	Bestell-Nr. Part-No.
RG 58 C/U	50	gecrimpt crimped	BN 69 20 08
RG 223/U	50	gecrimpt crimped	BN 69 20 09



BN 69 20 09

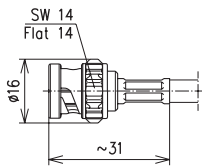

Kabelwinkelstecker – Right angle cable plug



BN 93 36 02

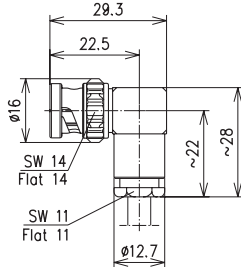

Kabel Typ Cable type	Ω	Ausführung Version	Bestell-Nr. Part-No.
RG 58 C/U	50	geklemmt clamped	BN 93 36 02
RG 142 B/U			
RG 223/U			
RG 400/U			

Steckerkopf – Connector head



BN 45 09 30

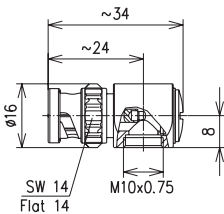

Bestell-Nr. Part-No.	Ω	BN 45 09 30
	50	Kabelabfangungen siehe Seite 77 Cable entries see page 77

GEHÄUSESTECKVERBINDER ■ FIXED CONNECTORS

BNC



BN 29 27 50

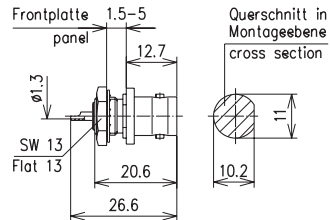

BN 29 27 50

Gehäusekuppler für Einlochbefestigung
 Innenleiter mit Lötanschluß
 Fixed socket for single hole mounting
 inner conductor with soldering connection



BN 29 08 00

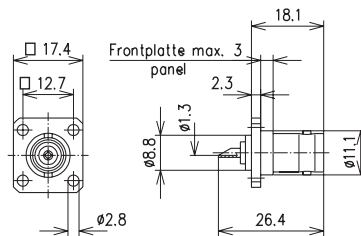

BN 29 08 00

Gehäusekuppler mit Viereckflansch
 Innenleiter mit Lötanschluß
 Fixed socket with four hole mounting flange
 inner conductor with soldering connection



BN 74 06 00

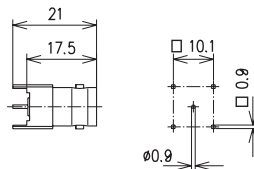

BN 74 06 00

Gehäusekuppler für gedruckte Schaltung
 Fixed socket for printed circuit boards



BN 74 06 02

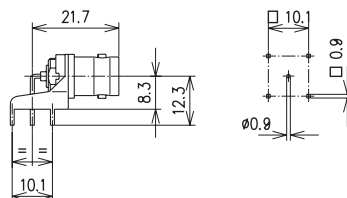

BN 74 06 02

Gehäusewinkelkuppler für gedruckte Schaltung
 Right angle fixed socket for printed circuit boards

ZWISCHENSTECKVERBINDER ■ WITHIN-TYPE ADAPTORS



BN 59 17 00

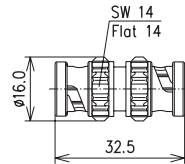

BN 59 17 00
Zwischenstecker
Adaptor, plug-plug

BNC



BN 59 18 00

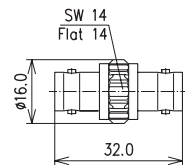

BN 59 18 00
Kupplung
Adaptor, socket-socket



BN 59 45 00

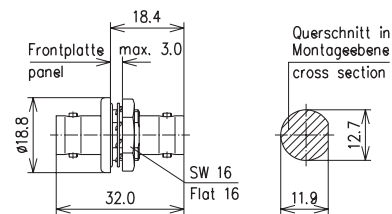

BN 59 45 00
Durchführungskupplung für
Einlochmontage (einbaudicht)
Fixed adaptor, socket-socket,
for single hole mounting (panel sealed)



BN 59 09 02

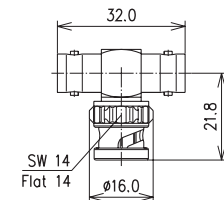

BN 59 09 02
T-Verzweigung,
Kuppler-Stecker-Kuppler
T-adaptor,
socket-plug-socket



BN 92 91 00

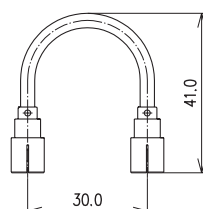

BN 92 91 00
Bügelstecker (Steck-Typ)
U-link (push-on-type), plug-plug

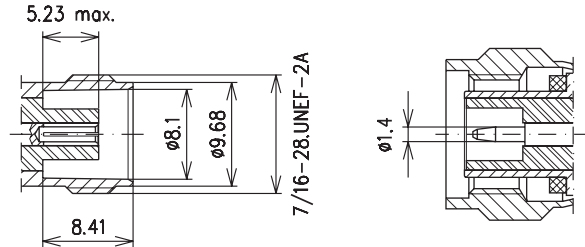

Die Steckverbindung TNC ist in Konstruktion und Abmessungen mit der Steckverbindung BNC identisch, besitzt jedoch eine Überwurfmutter anstelle der Bajonettverriegelung. TNC-Steckverbinder sind für einen Einsatzfrequenzbereich bis 11 GHz geeignet.

SPINNER verwendet eine ungeschlitzte Außenleiterkontakthülse, um einen erstklassigen Stirnkontakt zu gewährleisten. Aus diesem Grund sind die elektrischen Werte wesentlich besser als die der Steckverbindung BNC.

Die stabile Befestigung der Überwurfmutter durch Einrollen und das spezielle SPINNER-Profil ermöglichen ein Anzugsdrehmoment bis zu 3 Nm.

Die in der MIL angegebene Drahtsicherung der Überwurfmutter wird dadurch überflüssig.

Auf Wunsch können Stecker auch mit Bohrungen für eine Drahtsicherung geliefert werden.

In terms of design and dimensions the TNC connector is identical with the BNC connector, but it has a threaded coupling nut instead of the bayonet lock. TNC connectors are suitable for the frequency range up to 11 GHz.

SPINNER uses a non-slotted outer conductor contact to ensure perfect face contact. That is why the electrical parameters are significantly better than those of the BNC connector system.

The coupling nut has the special SPINNER profile and is fastened by flanging, allowing a tightening torque as high as 3 Nm.

That makes it unnecessary to secure the collar nut by a wire clip as specified in the MIL standard.

However, upon request we also deliver connectors with a bore for securing wire.

TNC leitet sich ab aus Threaded Neill Concelman, wird aber auch häufig als Threaded Navy Connector bezeichnet. Paul Neill ist der Erfinder der HF-Steckverbinder Serie N, Carl Concelman Erfinder der Serie C. TNC has originated from Threaded Neill Concelman, but it is often also referred to as Threaded Navy Connector. Paul Neill is the inventor of the RF connector series N, whereas Carl Concelman invented series C.

Elektrisch / Electrical	IEC 60169-17	IEC	SPINNER	Bemerkung / Remarks
Wellenwiderstand Characteristic impedance	10.2	50 Ω		
Frequenzbereich Frequency range	10.2	11 GHz		Stufe 2 Grade 2
VSWR	10.2	≤ 1.30		gerader Steckverbinder bei 11 GHz straight connector at 11 GHz
		≤ 1.35		Winkel-Steckverbinder bei 11 GHz right angle connector at 11 GHz
Innenleiter-Kontaktwiderstand Center contact resistance	10.2	≤ 1.5 mΩ		anfänglich initial
Außenleiter-Kontaktwiderstand Outer contact resistance	10.2	≤ 0.4 mΩ		anfänglich initial
Isolationswiderstand Insulation resistance	10.2	≥ 5 GΩ		anfänglich initial
Spannungsfestigkeit in Meereshöhe Proof voltage at sea level	10.2	1.0 kV	1.5 kV	40...65 Hz
Arbeitsspannung in Meereshöhe Working voltage at sea level	10.2	400 V	500 V	40...65 Hz
Wirksamkeit der Abschirmung Screening effectiveness	10.2	≥ 60 dB	≥ 100 dB	bis 3 GHz to 3 GHz

Mechanisch / Mechanical	IEC 60169-17	IEC	SPINNER	Bemerkung / Remarks
Kupplungsdrehmoment Coupling torque	10.2	0.46...0.69 Nm	3.0 Nm	
Prüfdrehmoment Proof torque	10.2	1.7 Nm	4.0 Nm	
Zugfestigkeit des Kupplungsmechanismus Tensile strength of coupling mechanism	10.2	445 N		
Mechanische Lebensdauer Mechanical lifetime	10.2	500	10000	Betätigungen Operations
Fesselung des Innenleiters Center contact captivation				ja yes

Umwelt / Environmental	IEC 60169-17	IEC	SPINNER	Bemerkung / Remarks
Klimaklasse / Climatic category	10.2	55/155/21		
Temperaturbereich / Temperature range	10.2	-55...+155 °C		
Schutzgrad / Degree of protection		IP68		gesteckt / mated

Werkstoffe und Oberflächenbehandlung / Materials and Surface Finish	
Federnde Kontaktteile Resilient contact members	hochfeste Cu-Legierung, versilbert (MIL-Typen Innenleiter vergoldet) high strength copper alloy, silver plated (MIL-types center conductor gold plated)
Isolation Insulation	PTFE/FEP
Innen- und Außenleiterkontaktteile Center and outer conductor parts	Cu-Legierung, versilbert (MIL-Typen Innenleiter vergoldet) Copper alloy, silver plated (MIL-types center conductor gold plated)
Sonstige Metallteile Other metal parts	Cu-Legierung, glanzvernickelt Copper alloy, bright nickel plated
Dichtungen Gaskets	Silikonkautschuk Silicone rubber

KABELSTECKVERBINDER ■ CABLE CONNECTORS

Kabelstecker – Straight cable plugs



BN 87 03 02

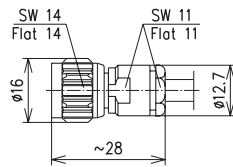

BN 73 90 02

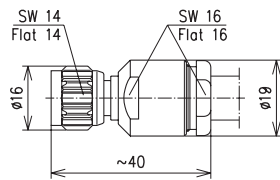

BN 73 65 90

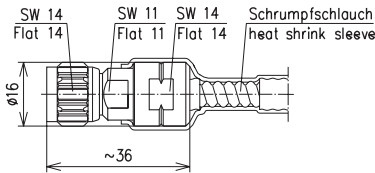

BN 73 65 16

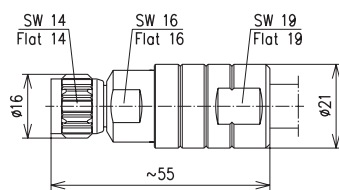

BN 73 65 88

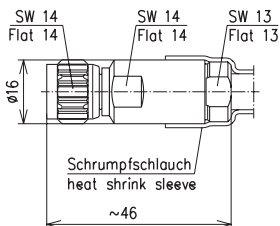

Kabel Typ Cable type	Ausführung Version	Bestell-Nr. Part-No.
RG 58 C/U	geklemmt clamped	BN 87 03 02
RG 142 B/U		
RG 223/U		
RG 400/U	geklemmt clamped	BN 73 90 02
RG 213/U		
RG 214/U	CAF® Schrumpfschlauch CAF® heat shrink sleeve	BN 73 65 90
SCF14-50	CAF® Profildichtung CAF® profile gasket	BN 73 65 16
SCF38-50	CAF® O-Ring	BN 73 65 88
LCF14-50		

TNC

KABELSTECKVERBINDER ■ CABLE CONNECTORS
Kabelstecker – Straight cable plugs

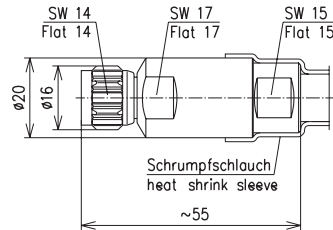

BN 73 65 68



Kabel Typ Cable type	Ausführung Version	Bestell-Nr. Part-No.
LCF38-50	CAF® O-Ring	BN 73 65 68

Kabelwinkelstecker – Right angle cable plugs

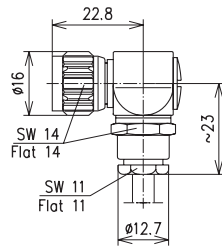

BN 74 56 12



Kabel Typ Cable type	Ausführung Version	Bestell-Nr. Part-No.
RG 58 C/U	geklemmt clamped	BN 74 56 12
RG 142 B/U		
RG 223/U		
RG 400/U		
LCF14-50	CAF® O-Ring	BN 73 65 87

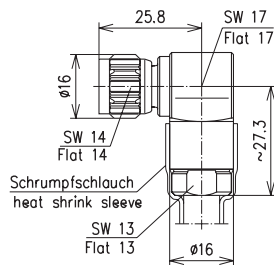

BN 73 65 87

Kabelkuppler – Straight cable socket

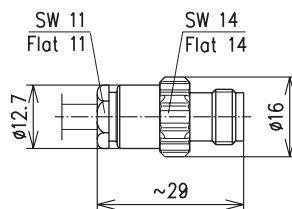

BN 71 56 00



Kabel Typ Cable type	Ausführung Version	Bestell-Nr. Part-No.
RG 58 C/U	geklemmt clamped	BN 71 56 00
RG 142 B/U		
RG 223/U		
RG 400/U		

Steckerkopf – Connector head

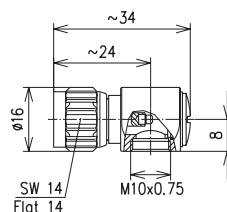
BN 45 09 35



Bestell-Nr. Part-No.	Bestell-Nr. Part-No.
	BN 45 09 35
	Kabelabfangungen siehe Seite 77 Cable entries see page 77

GEHÄUSESTECKVERBINDER ■ FIXED CONNECTORS



BN 87 48 50

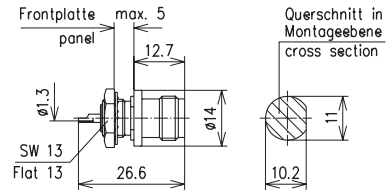

BN 87 48 50

Gehäusekuppler
für Einlochbefestigung
Innenleiter mit Lötanschluß
Fixed socket
for single hole mounting
inner conductor with soldering connection



BN 74 61 01

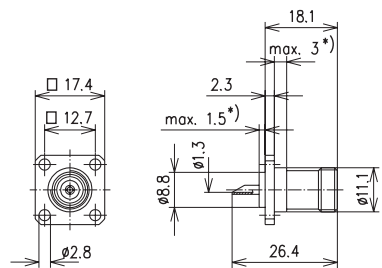

*) Frontplatte panel

BN 74 61 01

Gehäusekuppler mit
Viereckflansch
Innenleiter mit Lötanschluß
Fixed socket with
four hole mounting flange
inner conductor with soldering connection

ZWISCHENSTECKVERBINDER ■ WITHIN-TYPE ADAPTORS



BN 74 66 00

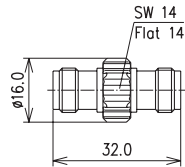

BN 74 66 00
Kupplung
Adaptor, socket-socket



BN 15 04 19

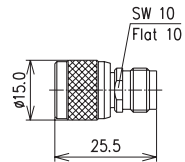

BN 15 04 19
Steckerkupplung
Adaptor, plug-socket



BN 74 71 00

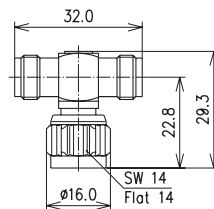

BN 74 71 00
T-Verzweigung,
Kuppler-Stecker-Kuppler
T-adaptor,
socket-plug-socket

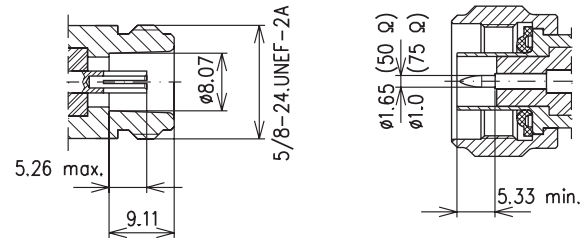

N-Steckverbinder gibt es in 50 Ω und 75 Ω Ausführungen. Das Stecksystem kann bis 11 GHz eingesetzt werden (Präzisionsausführung bis 18 GHz). Die 50 Ω Version wird vorwiegend in Mobilfunkanwendungen mit hohen mechanischen und elektrischen Anforderungen eingesetzt.

SPINNER liefert aus diesem Grund ausschließlich Steckverbinder mit ungeschlitzter Außenleiterkontakthülse und einer speziellen Profildichtung im Steckerkopf anstelle der nach IEC oder CECC vorgesehenen Flachdichtscheibe, um eine zuverlässige Dichtung sicherzustellen.

Die spezielle SPINNER-Profil Überwurfmutter unserer N-Stecker wird durch Einrollen im Außenleiter fixiert. Hierdurch wird das zulässige Anzugsdrehmoment wesentlich erhöht und der Kontaktdruck deutlich verbessert.

Die 50 Ω und 75 Ω Typen unterscheiden sich im Durchmesser des Innenleiters und dürfen deshalb nicht miteinander verbunden werden.

Zur Unterscheidung werden alle 75 Ω Kuppler von SPINNER mit einem gelben Farbring gekennzeichnet.

N connectors are available as 50 Ω and 75 Ω versions. The connector system can be used at frequencies up to 11 GHz (high-precision type up to 18 GHz).

The 50 Ω version is mainly employed in mobile communication applications with demanding mechanical and electrical requirements.

That is why SPINNER delivers exclusively connectors with non-slotted outer conductor contact and a special sealing profile in the connector head instead of the flat seal disk specified by IEC or CECC. This ensures a reliable sealing function.

The coupling nut on N connectors has the special SPINNER profile and is fastened by flanging in the outer conductor. This leads to a much higher tightening torque and clearly better contact pressure.

The 50 Ω and 75 Ω types have different inner conductor diameters, so they must not be connected with each other. To allow better distinction between them all 75 Ω SPINNER connectors are marked by a yellow colour ring.

Die Steckverbinder der Serie N sind benannt nach Ihrem Erfinder Paul Neill, der diese Norm 1942 entwickelte. Der Name wird allerdings auch häufig aus der Bezeichnung Navy Connector abgeleitet.

The N connectors have been named after their inventor, Paul Neill, who developed this standard in 1942. But frequently the name is also related to Navy Connector.



KOAXIALE STECKVERBINDER SERIE N 50 & 75 Ω

COAXIAL CONNECTORS TYPE N 50 & 75 Ω

Elektrisch / Electrical	IEC 60169-16	IEC	SPINNER	Bemerkung / Remarks
Wellenwiderstand Characteristic impedance	10.2	50 Ω (75 Ω)		
Frequenzbereich Frequency range	10.2	11 GHz (1GHz) 18 GHz		Stufe / Grade 2 Stufe / Grade 0 +1
VSWR	10.2	≤ 1.30		gerader Steckverbinder bei 11 GHz straight connector at 11 GHz
		≤ 1.50		Winkel-Steckverbinder bei 11 GHz right angle connector at 11 GHz
Innenleiter-Kontaktwiderstand Center contact resistance	10.2	≤ 1 mΩ		anfänglich initial
Außenleiter-Kontaktwiderstand Outer contact resistance	10.2	≤ 0.25 mΩ		anfänglich initial
Isolationswiderstand Insulation resistance	10.2	≥ 5 GΩ		anfänglich initial
Spannungsfestigkeit in Meereshöhe Proof voltage at sea level	10.2	2.5 kV		40...65 Hz
Arbeitsspannung in Meereshöhe Working voltage at sea level	10.2	1.0 kV	1.4 kV	40...65 Hz
Wirksamkeit der Abschirmung Screening effectiveness	10.2	≥ 90 dB	≥ 100 dB	

Mechanisch / Mechanical	IEC 60169-16	IEC	SPINNER	Bemerkung / Remarks
Kupplungsdrehmoment Coupling torque	10.2	0.7...1.1 Nm	3.0 Nm	
Prüfdrehmoment Proof torque	10.2	1.7 Nm	4.0 Nm	
Zugfestigkeit des Kupplungsmechanismus Tensile strength of coupling mechanism	10.2	450 N		
Mechanische Lebensdauer Mechanical lifetime	10.2	500	10000	Betätigungen Operations
Fesselung des Innenleiters Center contact captivation				ja yes

Umwelt / Environmental	IEC 60169-16	IEC	SPINNER	Bemerkung / Remarks
Klimaklasse / Climatic category	10.2	55/155/21		
Temperaturbereich / Temperature range	10.2	-55...+155 °C		
Schutzgrad / Degree of protection		IP68		gesteckt / mated

Werkstoffe und Oberflächenbehandlung / Materials and Surface Finish	
Federnde Kontaktteile Resilient contact members	hochfeste Cu-Legierung, versilbert (MIL-Typen Innenleiter vergoldet) high strength copper alloy, silver plated (MIL-types center conductor gold plated)
Isolation Insulation	PTFE/FEP
Innen- und Außenleiterkontaktteile Center and outer conductor parts	Cu-Legierung, versilbert (bei MIL-Typen Innenleiter vergoldet) Copper alloy, silver plated (with MIL-types center conductor gold plated)
Sonstige Metallteile Other metal parts	Cu-Legierung, glanzvernickelt Copper alloy, bright nickel plated
Dichtungen Gaskets	Silikonkautschuk Silicone rubber

Z

KABELSTECKVERBINDER ■ CABLE CONNECTORS

Kabelstecker – Straight cable plugs



BN 29 66 50

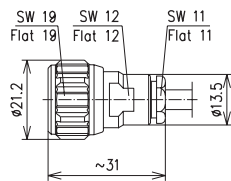

Kabel Typ Cable type	Ω	Ausführung Version	Bestell-Nr. Part-No.
RG 58 C/U RG 142 B/U RG 223/U RG 400/U	50	geklemmt clamped	BN 29 66 50
RG 59 B/U RG 62 A/U EPD 31475A	75	geklemmt clamped	BN 68 92 00
RG 402/U	50	gelötet soldered	BN 74 08 72
RG 401/U	50	gelötet soldered	BN 74 08 79
RG 8 Typen (low loss)	50	geklemmt clamped	BN 94 50 60



BN 68 92 00

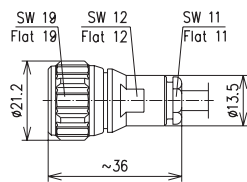

BN 74 08 72

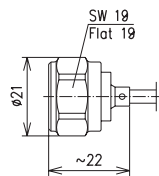

BN 74 08 79

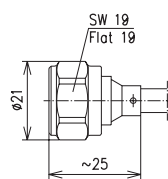

BN 94 50 60

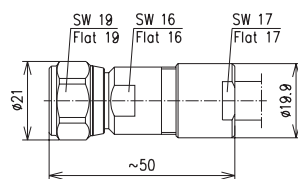

KABELSTECKVERBINDER ■ CABLE CONNECTORS

Kabelstecker – Straight cable plugs



BN 92 24 50

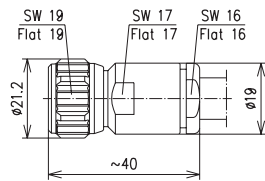

BN 92 24 75

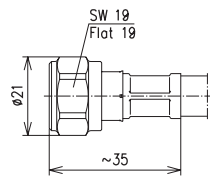

BN 94 50 00

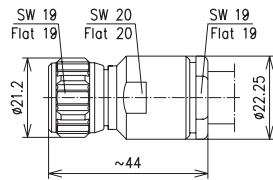

BN 92 27 00

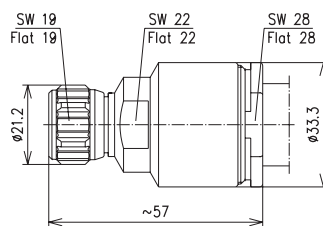

BN 84 47 60

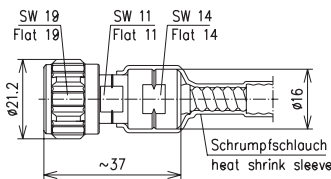

Kabel Typ Cable type	Ω	Ausführung Version	Bestell-Nr. Part-No.
RG 213/U	50	geklemmt	BN 92 24 50
RG 214/U		clamped	
RG 214/U	50	gecrimpt	BN 92 24 75
RG 393/U		crimped	
RG 217/U(RG 14A/U)	50	geklemmt	BN 94 50 00
		clamped	
RG 218/U(RG 17/U)	50	geklemmt	BN 92 27 00
		clamped	
SCF14-50	50	CAF® Schrumpfschlauch CAF® heat shrink sleeve	BN 84 47 60

Z

KABELSTECKVERBINDER ■ CABLE CONNECTORS

Kabelstecker – Straight cable plugs



BN 87 01 63

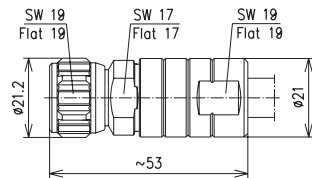

Kabel Typ Cable type	Ω	Ausführung Version	Bestell-Nr. Part-No.
SCF38-50	50	CAF® Profildichtung CAF® profile gasket	BN 87 01 63
SCF/UCF12-50	50	CAF® Profildichtung CAF® profile gasket	BN 87 01 57
HCA38-50	50	CAF® Plast 2000®	BN 97 04 18
HCA58-50	50	CAF® Plast 2000®	BN 92 53 18
HCA78-50	50	CAF® Plast 2000®	BN 49 21 18



BN 87 01 57

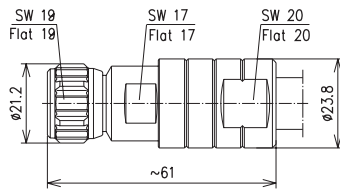

BN 97 04 18

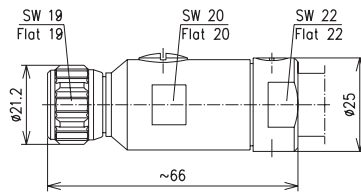

BN 92 53 18

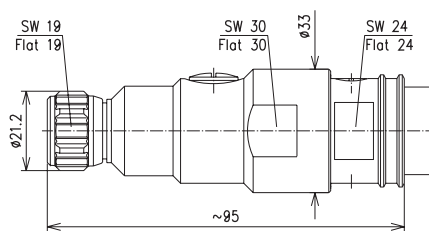

BN 49 21 18

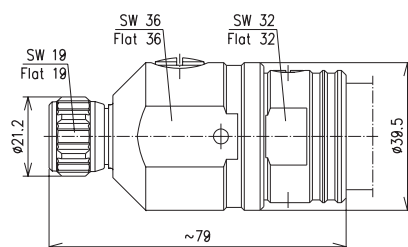

KABELSTECKVERBINDER ■ CABLE CONNECTORS

Kabelstecker – Straight cable plugs



BN 67 16 69

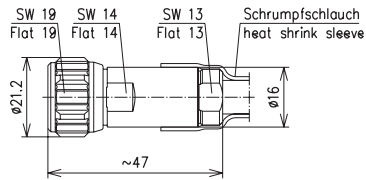

BN 84 47 55

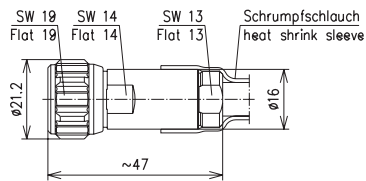

BN 87 01 69

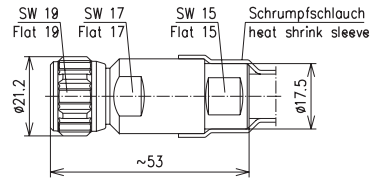

BN 87 01 68

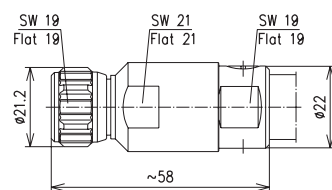

BN 87 01 89

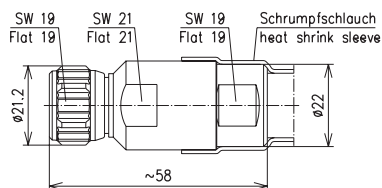

Kabel Typ Cable type	Ω	Ausführung Version	Bestell-Nr. Part-No.
LCF14-75	75	CAF® O-Ring	BN 67 16 69
LCF14-50	50	CAF® O-Ring	BN 84 47 55
LCF38-50	50	CAF® O-Ring	BN 87 01 69
LCF12-50	50	CAF® Plast 2000®	BN 87 01 68
LCF12-50	50	CAF® O-Ring	BN 87 01 89

Z

KABELSTECKVERBINDER ■ CABLE CONNECTORS

Kabelstecker – Straight cable plugs



BN 78 97 45

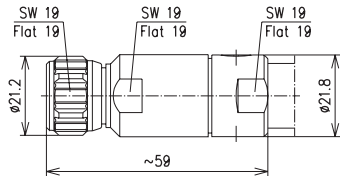

Kabel Typ Cable type	Ω	Ausführung Version	Bestell-Nr. Part-No.
LCF12-75	75	CAF® Plast 2000®	BN 78 97 45
LCF/UCF78-50	50	CAF® Plast 2000®	BN 70 67 40
LCF/UCF78-50	50	CAF® O-Ring	BN 70 67 41
LCF/UCF78-50	50	TOPSPIN® O-Ring	BN 70 67 11



BN 70 67 40

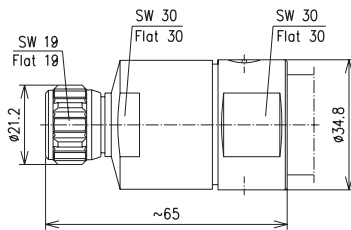

BN 70 67 41

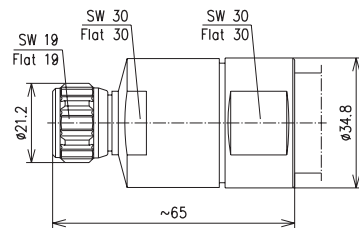

BN 70 67 11

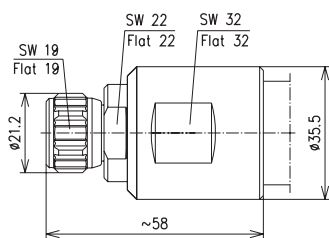

KABELSTECKVERBINDER ■ CABLE CONNECTORS

Kabelstecker – Straight cable plugs



BN 70 67 42

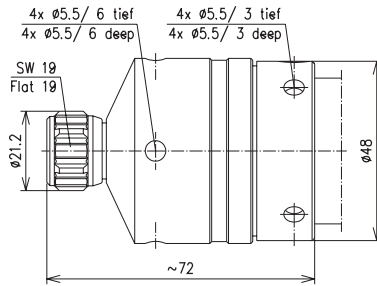

Kabel Typ Cable type	Ω	Ausführung Version	Bestell-Nr. Part-No.
UCF/LCFS114-50	50	CAF® Plast 2000®	BN 70 67 42
UCF/LCFS114-50	50	CAF® O-Ring	BN 70 67 43
LCF158-50	50	CAF® Plast 2000®	BN 70 67 44
LCF158-50	50	CAF® O-Ring	BN 70 67 45



BN 70 67 43

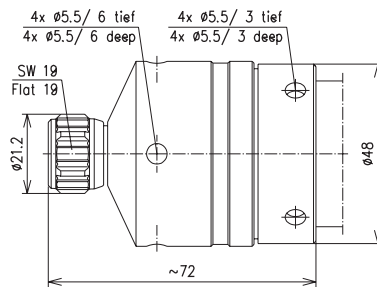

BN 70 67 44

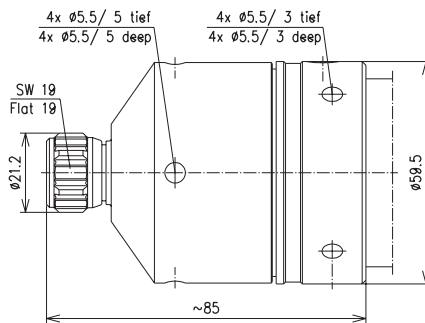

BN 70 67 45

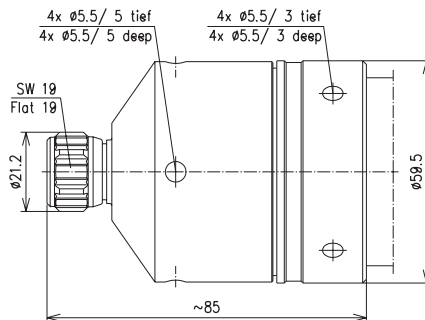

Z

KABELSTECKVERBINDER ■ CABLE CONNECTORS

Kabelstecker – Straight cable plugs



BN 55 71 10

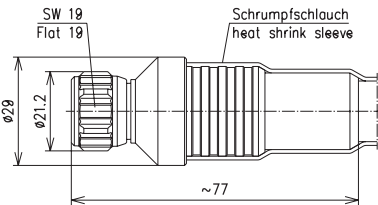

Kabel Typ Cable type	Ω	Ausführung Version	Bestell-Nr. Part-No.
RADIAFLEX® 12-50	50	Schrumpfschlauch Heat shrink sleeve	BN 55 71 10
RADIAFLEX® 58-50	50	Schrumpfschlauch Heat shrink sleeve	BN 52 71 91
RADIAFLEX® 78-50	50	Schrumpfschlauch Heat shrink sleeve	BN 55 71 50
RADIAFLEX® 114-50	50	Schrumpfschlauch Heat shrink sleeve	BN 55 71 60
RADIAFLEX® 158-50	50	Schrumpfschlauch Heat shrink sleeve	BN 55 71 70



BN 52 71 91

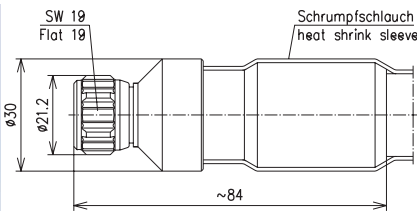

BN 55 71 50

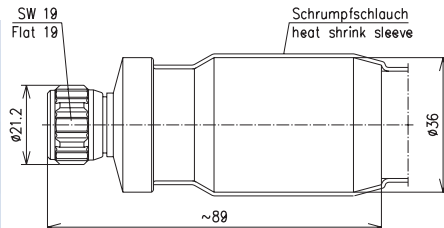

BN 55 71 60

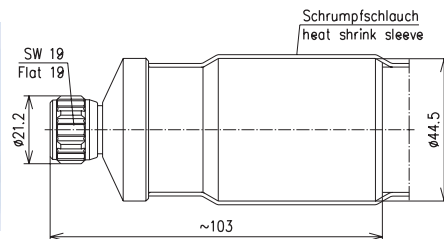

BN 55 71 70

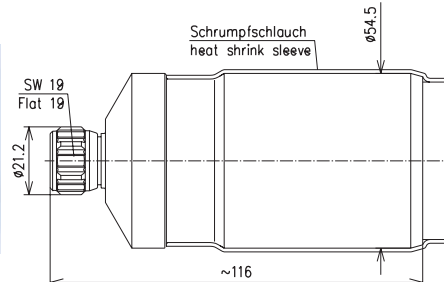

KABELSTECKVERBINDER ■ CABLE CONNECTORS

Kabelwinkelstecker – Right angle cable plugs



BN 72 12 80

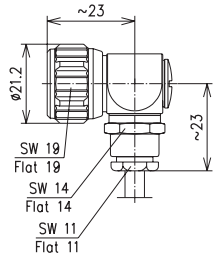

BN 94 50 61

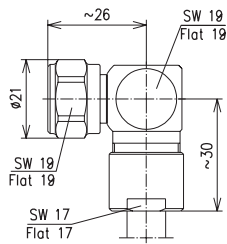

BN 72 12 82

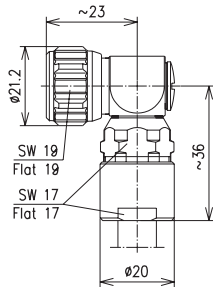

BN 72 12 83

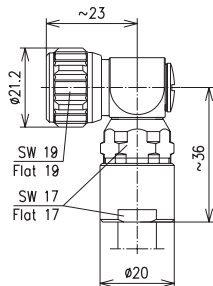

Kabel Typ Cable type	Ω	Ausführung Version	Bestell-Nr. Part-No.
RG 58 C/U RG 142 B/U RG 223/U RG 400/U	50	geklemmt clamped	BN 72 12 80
RG 8 Typen (low loss)	50	geklemmt clamped	BN 94 50 61
RG 213/U	50	geklemmt clamped	BN 72 12 82
RG 214/U RG 393/U	50	geklemmt clamped	BN 72 12 83

Z

KABELSTECKVERBINDER ■ CABLE CONNECTORS

Kabelwinkelstecker – Right angle cable plugs



BN 75 78 60

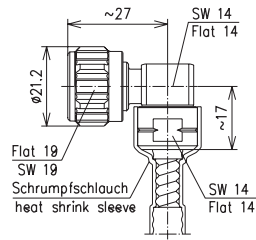

Kabel Typ Cable type	Ω	Ausführung Version	Bestell-Nr. Part-No.
SCF14-50	50	CAF® Schrumpfschlauch CAF® heat shrink sleeve	BN 75 78 60
SCF/UCF12-50	50	CAF® Profildichtung CAF® profile gasket	BN 87 01 56
LCF14-50	50	CAF® O-Ring	BN 75 78 55



BN 87 01 56

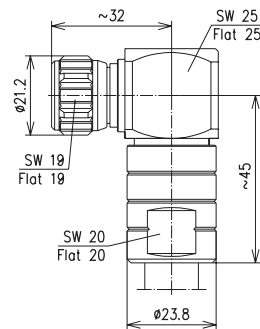

BN 75 78 55

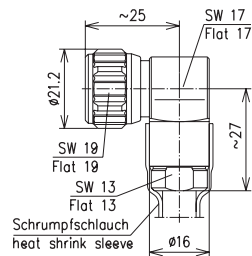

KABELSTECKVERBINDER ■ CABLE CONNECTORS

Kabelwinkelstecker – Right angle cable plugs



BN 87 01 70

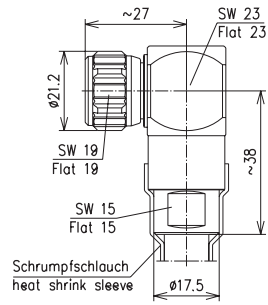

Kabel Typ Cable type	Ω	Ausführung Version	Bestell-Nr. Part-No.
LCF38-50	50	CAF® O-Ring	BN 87 01 70
LCF12-50	50	CAF® Plast 2000®	BN 87 01 67
LCF12-50	50	CAF® O-Ring	BN 87 01 87



BN 87 01 67

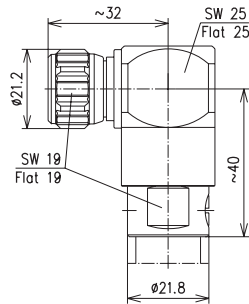

BN 87 01 87

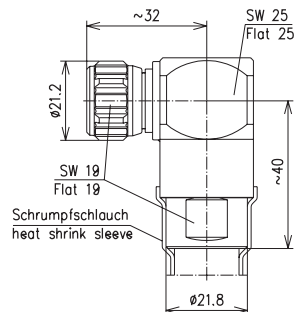

KABELSTECKVERBINDER ■ CABLE CONNECTORS

Kabelkuppler – Straight cable sockets



BN 92 25 50

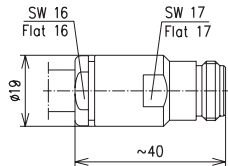

Kabel Typ Cable type	Ω	Ausführung Version	Bestell-Nr. Part-No.
RG 213/U RG 214/U	50	geklemmt clamped	BN 92 25 50
SCF14-50	50	CAF® Schrumpfschlauch CAF® heat shrink sleeve	BN 84 55 60
SCF38-50	50	CAF® Profildichtung CAF® profile gasket	BN 84 60 63
SCF/UCF12-50	50	CAF® Profildichtung CAF® profile gasket	BN 84 60 57
HCA38-50	50	CAF® Plast 2000®	BN 97 05 18



BN 84 55 60

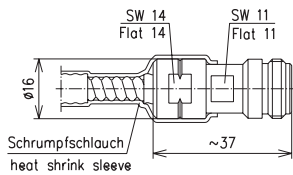

BN 84 60 63

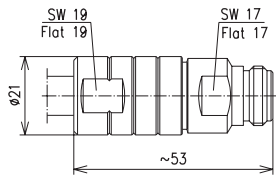

BN 84 60 57

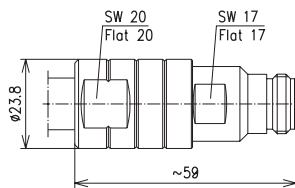

BN 97 05 18

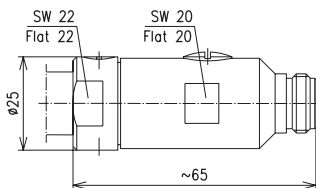

KABELSTECKVERBINDER ■ CABLE CONNECTORS

Kabelkuppler – Straight cable sockets



BN 92 54 18

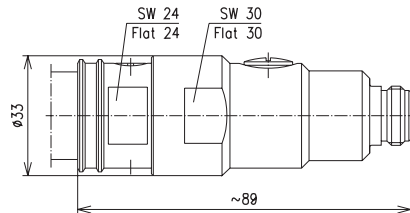

BN 49 17 18

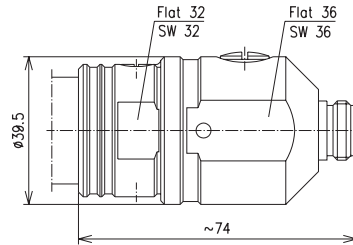

BN 84 55 55

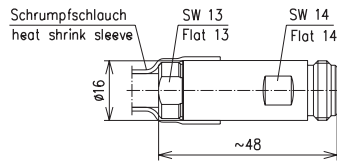

BN 84 60 69

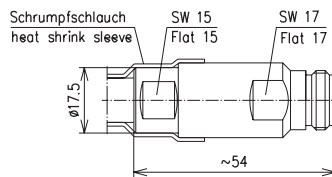

BN 84 60 68

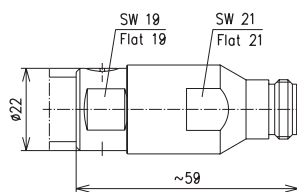

Kabel Typ Cable type	Ω	Ausführung Version	Bestell-Nr. Part-No.
HCA58-50	50	CAF® Plast 2000®	BN 92 54 18
HCA78-50	50	CAF® Plast 2000®	BN 49 17 18
LCF14-50	50	CAF® O-Ring	BN 84 55 55
LCF38-50	50	CAF® O-Ring	BN 84 60 69
LCF12-50	50	CAF® Plast 2000®	BN 84 60 68

Z

KABELSTECKVERBINDER ■ CABLE CONNECTORS

Kabelkuppler – Straight cable sockets



BN 84 60 89

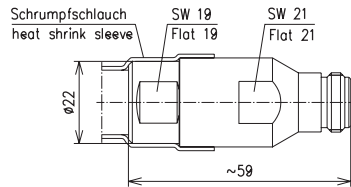

Kabel Typ Cable type	Ω	Ausführung Version	Bestell-Nr. Part-No.
LCF12-50	50	CAF® O-Ring	BN 84 60 89
LCF12-75	75	CAF® Plast 2000®	BN 88 54 45
LCF/UCF78-50	50	CAF® Plast 2000®	BN 84 63 40
LCF/UCF78-50	50	CAF® O-Ring	BN 84 63 41
LCF/UCF78-50	50	TOPSPIN® O-Ring	BN 84 63 11



BN 88 54 45

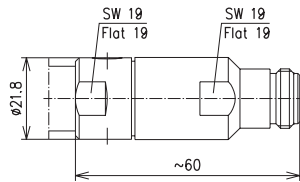

BN 84 63 40

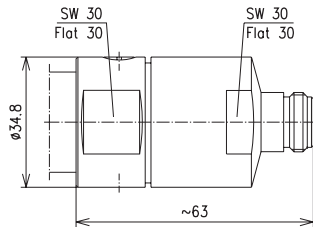

BN 84 63 41

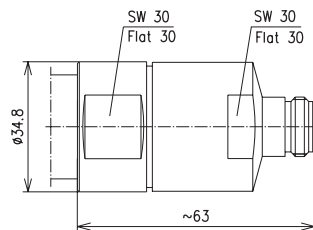

BN 84 63 11

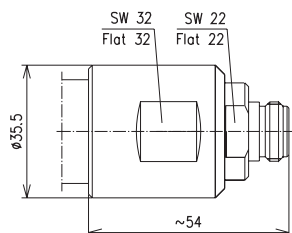

KABELSTECKVERBINDER ■ CABLE CONNECTORS

Kabelkuppler – Straight cable sockets



BN 84 63 42

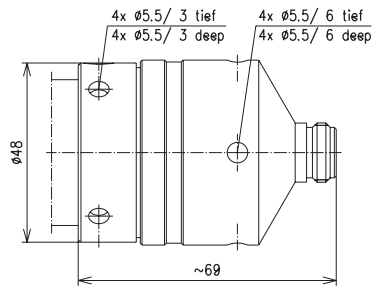

Kabel Typ Cable type	Ω	Ausführung Version	Bestell-Nr. Part-No.
UCF/LCFS/114-50	50	CAF® Plast 2000®	BN 84 63 42
UCF/LCFS/114-50	50	CAF® O-Ring	BN 84 63 43
LCF158-50	50	CAF® Plast 2000®	BN 84 63 44
LCF158-50	50	CAF® O-Ring	BN 84 63 45



BN 84 63 43

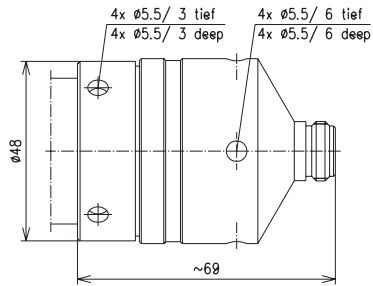

BN 84 63 44

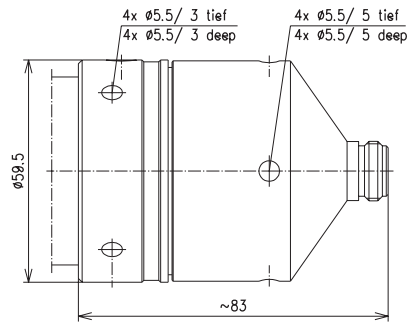

BN 84 63 45

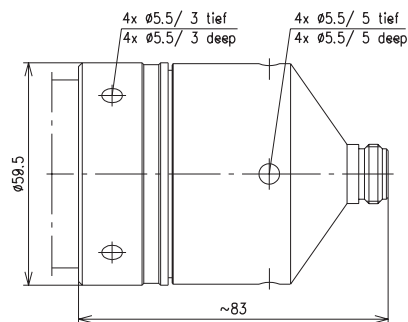

Z

KABELSTECKVERBINDER ■ CABLE CONNECTORS

Kabelkuppler – Straight cable sockets



BN 55 71 11

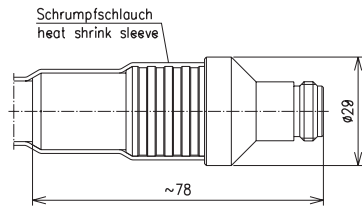

BN 52 71 92

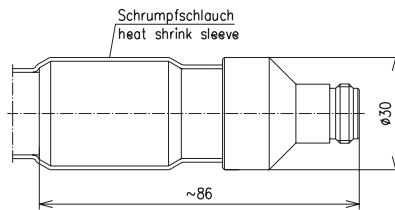

BN 55 71 51

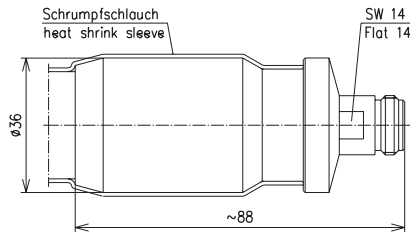

BN 55 71 61

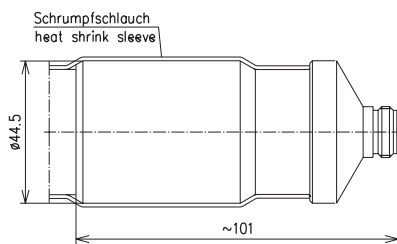

BN 55 71 71

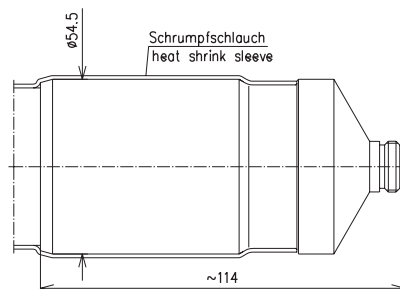

Kabel Typ Cable type	Ω	Ausführung Version	Bestell-Nr. Part-No.
RADIAFLEX® 12-50	50	Schrumpfschlauch Heat shrink sleeve	BN 55 71 11
RADIAFLEX® 58-50	50	Schrumpfschlauch Heat shrink sleeve	BN 52 71 92
RADIAFLEX® 78-50	50	Schrumpfschlauch Heat shrink sleeve	BN 55 71 51
RADIAFLEX® 114-50	50	Schrumpfschlauch Heat shrink sleeve	BN 55 71 61
RADIAFLEX® 158-50	50	Schrumpfschlauch Heat shrink sleeve	BN 55 71 71

KABELSTECKVERBINDER ■ CABLE CONNECTORS

Gehäusekuppler mit Viereckflansch – Fixed sockets with four hole mounting flange



BN 97 98 50

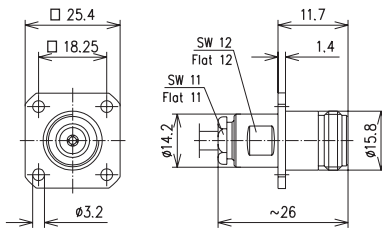

Kabel Typ Cable type	Ω	Ausführung Version	Bestell-Nr. Part-No.
RG 58 C/U	50	geklemmt clamped	BN 97 98 50
RG 142 B/U			
RG 223/U			
RG 400/U	50	geklemmt clamped	BN 92 26 50
RG 213/U			
RG 214/U			
LCF14-50	50	CAF® O-Ring	BN 74 76 45
LCF12-50	50	CAF® Plast 2000®	BN 74 75 44



BN 92 26 50

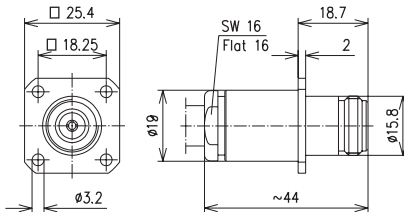

BN 74 76 45

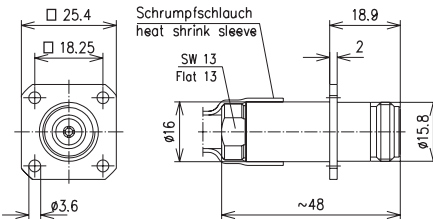

BN 74 75 44

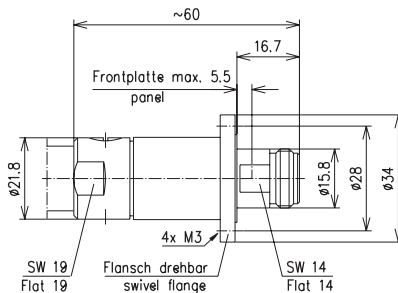

Z

KABELSTECKVERBINDER ■ CABLE CONNECTORS

Steckerkopf – Connector head



BN 45 09 40

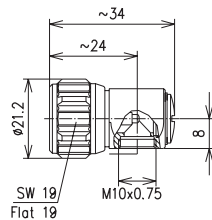

Bestell-Nr.	BN 45 09 40
Part-No.	Kabelabfangungen siehe Seite 77 Cable entries see page 77

GEHÄUSESTECKVERBINDER ● FIXED CONNECTORS



BN 29 82 00

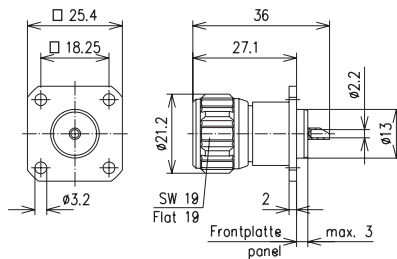

BN 29 82 00

Gehäusestecker mit Viereckflansch
Innenleiter mit Lötanschluß
Fixed plug with four hole mounting flange
inner conductor with soldering connection



BN 93 50 00

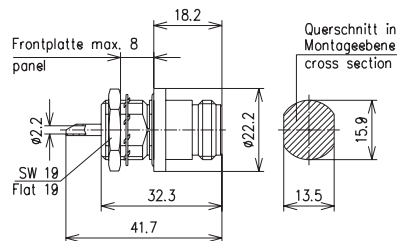

BN 93 50 00

Gehäusekuppler für Einlochbefestigung, einbau- und längsdicht
Innenleiter mit Lötanschluß
Fixed socket for single hole mounting, panel and barrier sealed
inner conductor with soldering connection



BN 29 05 70

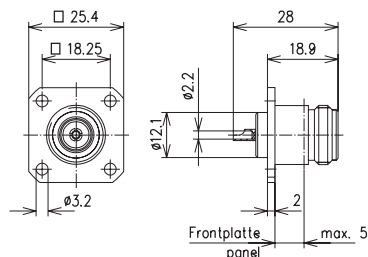

BN 29 05 70

Gehäusekuppler mit Viereckflansch
Innenleiter mit Lötanschluß
Fixed socket with four hole mounting flange
inner conductor with soldering connection

ZWISCHENSTECKVERBINDER ■ WITHIN TYPE ADAPTORS



BN 29 36 50

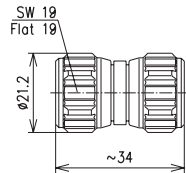

BN 29 36 50
Zwischenstecker
Adaptor, plug-plug



BN 70 82 50

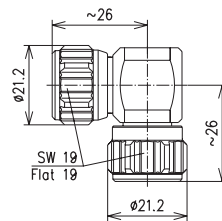

BN 70 82 50
Winkelzwischenstecker
Right angle adaptor, plug-plug



BN 29 37 50

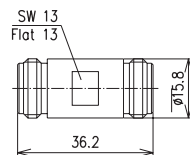

BN 29 37 50
Kupplung
Adaptor, socket-socket



BN 94 49 50

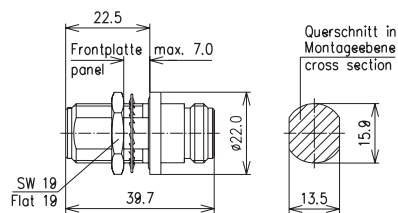

BN 94 49 50
Durchführungskupplung für Einloch-
montage (einbau- und längsdicht)
Fixed adaptor, socket-socket,
for single hole mounting
(panel and barrier sealed)

ZWISCHENSTECKVERBINDER ■ WITHIN TYPE ADAPTORS



BN 94 49 51

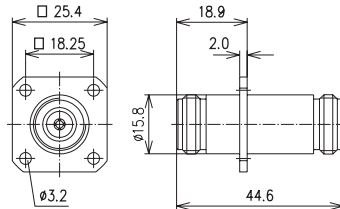

BN 94 49 51

Durchführungskupplung mit Viereckflansch
Fixed adaptor, socket-socket, with four hole mounting flange



BN 75 23 50

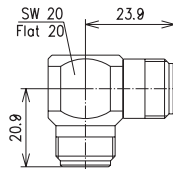

BN 75 23 50

Winkelkupplung
Right angle adaptor, socket-socket



BN 29 97 50

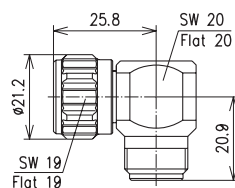

BN 29 97 50

Winkelsteckerkupplung
Right angle adaptor, plug-socket



BN 85 98 00

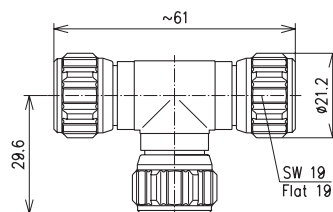

BN 85 98 00

T-Verzweigung,
Stecker-Stecker-Stecker
T-adaptor,
plug-plug-plug

ZWISCHENSTECKVERBINDER ■ WITHIN TYPE ADAPTORS



BN 93 60 00

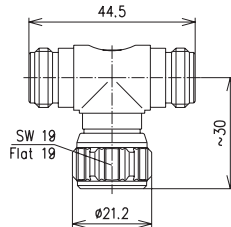

BN 93 60 00
T-Verzweigung,
Kuppler-Stecker-Kuppler
T-adaptor,
socket-plug-socket



BN 74 08 03

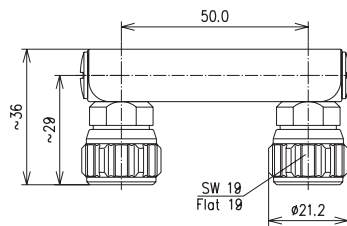

BN 74 08 03
Bügelstecker
U-link, plug-plug

SCHUTZKAPPEN ■ PROTECTIVE CAPS



BN 99 88 00

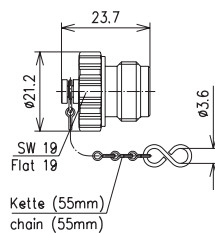

BN 99 88 00
Schutzkappe (Cu-Legierung)
für Stecker, mit Kette
Protective cap (copper alloy)
for plug, with chain



BN 29 63 00

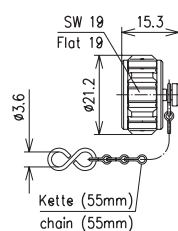

BN 29 63 00
Schutzkappe (Cu-Legierung)
für Kuppler, mit Kette
Protective cap (copper alloy)
for socket, with chain

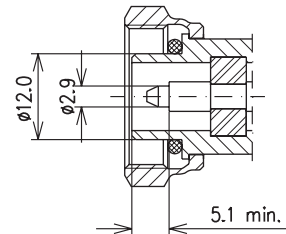
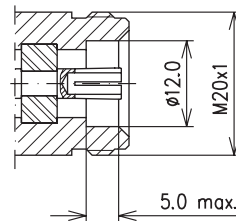

SPINNER 4,1-9,5 Steckverbinder eignen sich bestens für Anwendungen in Mobilfunksystemen wie GSM oder UMTS.

Die bis 14 GHz einsetzbare 4,1-9,5 Steckverbindung ist durch ihre mechanische und HF-technische Konstruktion nahezu gleichwertig mit dem Stecksystem 7-16, obwohl ihre Außenabmessungen deutlich geringer sind.

4,1-9,5 Steckverbinder sind mechanisch äußerst stabil und für Außenmontage unter härtesten Bedingungen geeignet. Durch die verwendeten Materialien werden sie höchsten Ansprüchen an Dämpfung und Intermodulationsfreiheit gerecht.

SPINNER 4.1-9.5 connectors are perfectly suited for applications in mobile communication systems such as GSM or UMTS.

The 4.1-9.5 connectors can be used up to 14 GHz. Their mechanical and RF design makes them almost equivalent to connector system 7-16, but their outer dimensions are clearly smaller.

4.1-9.5 connectors feature outstanding mechanical stability that makes them suitable for outdoor installation even in the most unfavourable environments.

Due to the careful selection of materials they meet the highest demands in terms of attenuation and inter-modulation properties.

Der Name 4,1-9,5 ist abgeleitet aus den Abmessungen des Innen- und Außenleiters, d.h. der Innenleiter hat einen Außendurchmesser von 4,1 mm und der Außenleiter einen Innendurchmesser von 9,5 mm.

The designation 4.1-9.5 is derived from the dimensions of the inner and outer conductors. The inner conductor has a rated outer diameter of 4.1 mm, and the outer conductor has a rated inner diameter of 9.5 mm.



Elektrisch / Electrical	IEC 60169-11	IEC	SPINNER	Bemerkung / Remarks
Wellenwiderstand Characteristic impedance		50 Ω		
Frequenzbereich Frequency range	3.	14 GHz		Stufe 1 Grade 1
VSWR	3.	≤ 1.22		Stufe 1 Grade 1
Innenleiter-Kontaktwiderstand Center contact resistance	9.3.2	≤ 1 mΩ		anfänglich initial
Außenleiter-Kontaktwiderstand Outer contact resistance	9.3.3	≤ 0.1 mΩ		anfänglich initial
Isolationswiderstand Insulation resistance	9.1	≥ 5 GΩ		anfänglich initial
Spannungsfestigkeit in Meereshöhe Proof voltage at sea level	3.	2.5 kV		50...60 Hz
Arbeitsspannung in Meereshöhe Working voltage at sea level	3.	1.4 kV		50...60 Hz
Wirksamkeit der Abschirmung Screening effectiveness	9.3.3	≥ 114 dB		

Mechanisch / Mechanical	IEC 60169-11	IEC	SPINNER	Bemerkung / Remarks
Kupplungsdrehmoment Coupling torque	9.3.3	10 Nm		
Mechanische Lebensdauer Mechanical lifetime	9.3.2.1	500	10000	Betätigungen Operations
Fesselung des Innenleiters Center contact captivation				ja yes

Umwelt / Environmental	IEC 60169-11	IEC	SPINNER	Bemerkung / Remarks
Klimaklasse / Climatic category	4.	55/155/56		
Temperaturbereich / Temperature range	4.	-55...+155 °C		
Schutzgrad / Degree of protection		IP68		gesteckt / mated

Werkstoffe und Oberflächenbehandlung / Materials and Surface Finish	
Federnde Kontaktteile Resilient contact members	hochfeste Cu-Legierung, versilbert high strength copper alloy, silver plated
Isolation Insulation	PTFE/FEP
Innen- und Außenleiterkontaktteile Center and outer conductor parts	Cu-Legierung, versilbert Copper alloy, silver plated
Sonstige Metallteile Other metal parts	Cu-Legierung, glanzvernickelt Copper alloy, bright nickel plated
Dichtungen Gaskets	Silikonkautschuk Silicone rubber

KABELSTECKVERBINDER ■ CABLE CONNECTORS

Kabelstecker – Straight cable plugs



BN 45 03 68

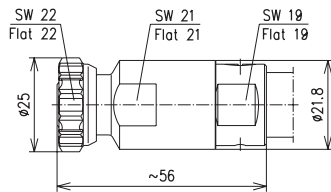

Kabel Typ Cable type	Ausführung Version	Bestell-Nr. Part-No.
LCF12-50	CAF® Plast 2000®	BN 45 03 68
SCF12-50	CAF® Schrumpfschlauch CAF® heat shrink sleeve	BN 45 03 40



BN 45 03 40

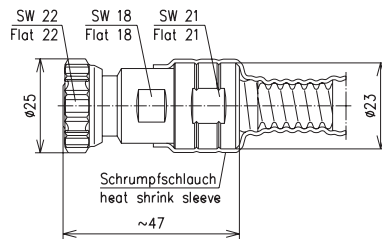

KABELSTECKVERBINDER ■ CABLE CONNECTORS

Steckerkopf – Connector head



BN 45 09 60

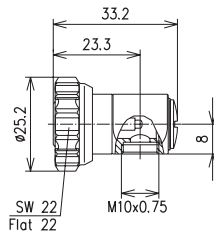

Bestell-Nr.	BN 45 09 60
Part-No.	Kabelabfangungen siehe Seite 77 Cable entries see page 77

GEHÄUSESTECKVERBINDER ■ FIXED CONNECTOR



BN 98 12 42

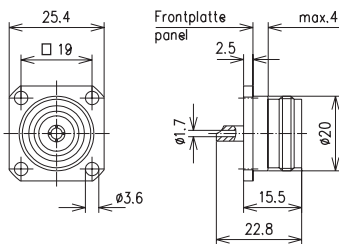

BN 98 12 42
Gehäusekuppler mit
Viereckflansch
Fixed socket with four hole
mounting flange

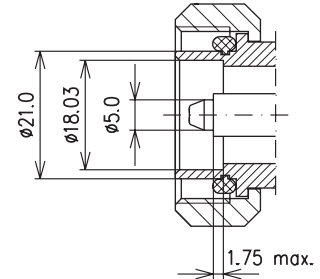
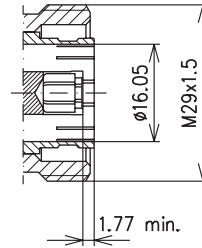

Der 7-16 Steckverbinder hat sich durch seine herausragenden mechanischen und elektrischen Eigenschaften zum weltweit am meisten verwendeten koaxialen Stecksystem für Mobilfunk-Sendeanlagen entwickelt.

Um eine optimale Intermodulationsdämpfung von typ. -165 dBc zu erhalten, sind alle Innen- und Außenleiterteile der SPINNER Standardausführung versilbert. Unterstützend werden ausschließlich nicht-magnetische Werkstoffe verwendet und die Anzahl der HF-Kontaktstellen ist minimiert.

Die Steckverbindung ist besonders geeignet für die Übertragung mittlerer und hoher Leistungen, u. a. im Outdoor-Bereich, bis zu einer Frequenz von 8,3 GHz. Wie bei allen anderen SPINNER Steckverbindern sind auch unsere 7-16 Stecker mit der speziellen SPINNER-Profil Überwurfmutter versehen. Diese ermöglicht in Verbindung mit der Befestigung durch Einrollen ein erhöhtes Prüfdrehmoment von bis zu 55 Nm.

The 7-16 connector has come to be the most frequently used coaxial connection system for mobile communication transmitter systems due to its excellent mechanical and electrical properties.

In order to achieve the optimum intermodulation performance of typically -165 dBc SPINNER applies silver-plating on all inner and outer conductor parts of the standard version. As a supporting measure we use exclusively non-magnetic materials, and we have minimised the number of RF contact points.

The connection is especially suited for transmitting medium or high power, also outdoors, up to a frequency of 8.3 GHz. Like all other SPINNER connectors our 7-16 connectors are also equipped with the special SPINNER profile coupling nut. This nut, which is fastened by flanging, allows a high test torque up to 55 Nm.

Die 50 Ω Steckverbindung 7-16 ist eine Variante des in den 1960er Jahren entwickelten 6-16 Stecksystems (60 Ω), an dessen Entwicklung und Normung SPINNER maßgeblich beteiligt war. Die Bezeichnung ist abgeleitet von den metrischen Abmessungen des Innen- und Außenleiters.

The 50 Ω connector 7-16 is a variant of the connector system 6-16 (60 Ω) developed in the 1960s with SPINNER strongly involved in its development and standardisation. The designation is derived from the metric dimensions of the inner and outer conductor.



Elektrisch / Electrical	IEC 60169-4	IEC	SPINNER	Bemerkung / Remarks
Wellenwiderstand Characteristic impedance		50 Ω		
Frequenzbereich Frequency range	3.	7.5 GHz	8.3 GHz	
VSWR	3.	≤ 1.22		gerader Steckverbinder bis 6 GHz straight connector up to 6 GHz
Innenleiter-Kontaktwiderstand Center contact resistance	9.4.2	≤ 0.4 mΩ		anfänglich initial
Außenleiter-Kontaktwiderstand Outer contact resistance	9.8.2	≤ 0.02 mΩ		anfänglich initial
Isolationswiderstand Insulation resistance	9.1	≥ 10 GΩ		anfänglich initial
Spannungsfestigkeit in Meereshöhe Proof voltage at sea level	9.1	4 kV		50...60 Hz
Arbeitsspannung in Meereshöhe Working voltage at sea level	3.	2.7 kV		50...60 Hz
Wirksamkeit der Abschirmung Screening effectiveness	9.8.2	≥ 128 dB		

Mechanisch / Mechanical	IEC 60169-4	IEC	SPINNER	Bemerkung / Remarks
Kupplungsdrehmoment Coupling torque	9.5	25 Nm	25...30 Nm	
Prüfdrehmoment Proof torque		35 Nm	55 Nm	
Zugfestigkeit des Kupplungsmechanismus Tensile strength of coupling mechanism			1000 N	
Mechanische Lebensdauer Mechanical lifetime	9.5	500	10000	Betätigungen Operations
Fesselung des Innenleiters Center contact captivation				ja yes

Umwelt / Environmental	IEC 60169-4	IEC	SPINNER	Bemerkung / Remarks
Klimaklasse / Climatic category	4.	55/155/56		
Temperaturbereich / Temperature range	4.	-55...+155 °C		
Schutzgrad / Degree of protection		IP68		gesteckt / mated

Werkstoffe und Oberflächenbehandlung / Materials and Surface Finish	
Federnde Kontaktteile Resilient contact members	hochfeste Cu-Legierung, versilbert high strength copper alloy, silver plated
Isolation Insulation	PTFE/FEP
Innen- und Außenleiterkontaktteile Center and outer conductor parts	Cu-Legierung, versilbert Copper alloy, silver plated
Sonstige Metallteile Other metal parts	Cu-Legierung, glanzvernickelt Copper alloy, bright nickel plated
Dichtungen Gaskets	Silikonkautschuk Silicone rubber

KABELSTECKVERBINDER ■ CABLE CONNECTORS

Kabelstecker – Straight cable plugs



BN 80 76 25

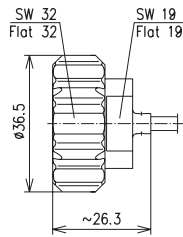

Kabel Typ Cable type	Ausführung Version	Bestell-Nr. Part-No.
RG 402/U	gelötet soldered	BN 80 76 25
RG 401/U Semirigid flexibel 250	gelötet soldered	BN 80 76 21
RG 213/U	geklemmt clamped	BN 19 59 20
RG 214/U RG 393/U	geklemmt clamped	BN 95 18 20



BN 80 76 21

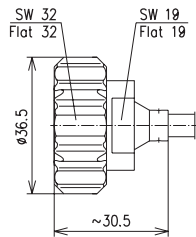

BN 19 59 20

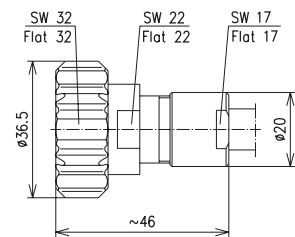

BN 95 18 20

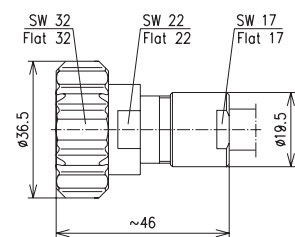

KABELSTECKVERBINDER ■ CABLE CONNECTORS

Kabelstecker – Straight cable plugs



BN 95 18 22

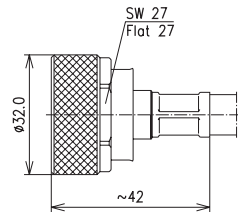

Kabel Typ Cable type	Ausführung Version	Bestell-Nr. Part-No.
RG 214/U	gecrimpt	BN 95 18 22
RG 393/U	crimped	
RG 217/U	geklemmt	BN 59 06 00
	clamped	
RG 218/U	geklemmt	BN 93 26 00
	clamped	
SCF14-50	CAF® Schrumpfschlauch CAF® heat shrink sleeve	BN 74 14 60



BN 59 06 00

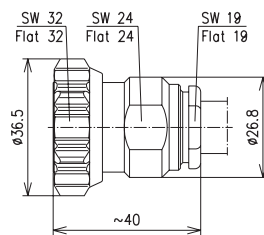

BN 93 26 00

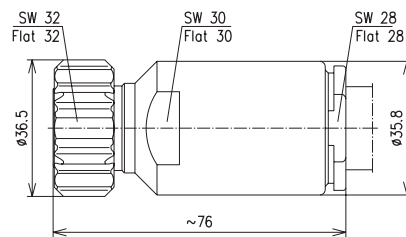

BN 74 14 60

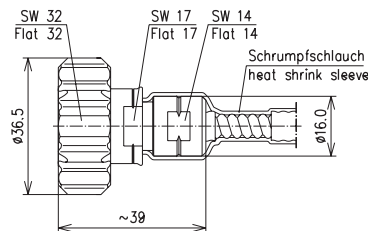

KABELSTECKVERBINDER ■ CABLE CONNECTORS

Kabelstecker – Straight cable plugs



BN 84 73 39

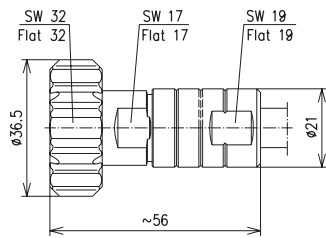

Kabel Typ Cable type	Ausführung Version	Bestell-Nr. Part-No.
SCF38-50	CAF® Profildichtung CAF® profile gasket	BN 84 73 39
SCF/UCF12-50	CAF® Profildichtung CAF® profile gasket	BN 84 73 59
HCA38-50	CAF® Plast 2000®	BN 97 06 28
HCA58-50	CAF® Plast 2000®	BN 92 55 25



BN 84 73 59

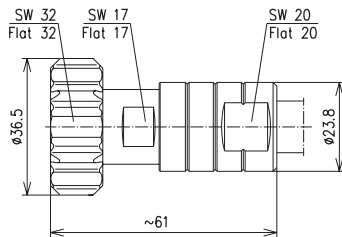

BN 97 06 28

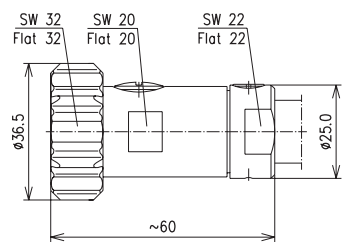

BN 92 55 25

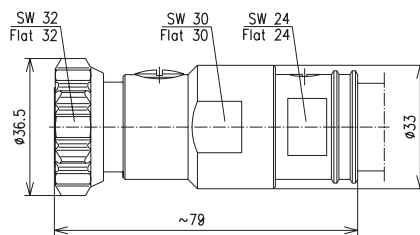

7-16

KABELSTECKVERBINDER ■ CABLE CONNECTORS

Kabelstecker – Straight cable plugs



BN 49 18 18

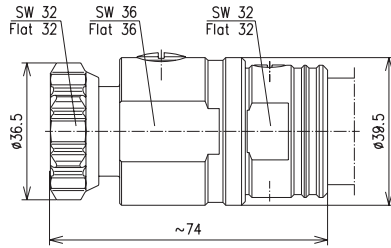

Kabel Typ Cable type	Ausführung Version	Bestell-Nr. Part-No.
HCA78-50	CAF® Plast 2000®	BN 49 18 18
HCA158-50	Premium Plast 2000®	BN 69 06 10
LCF14-50	CAF® O-Ring	BN 74 14 45
LCF38-50	CAF® O-Ring	BN 84 73 69



BN 69 06 10

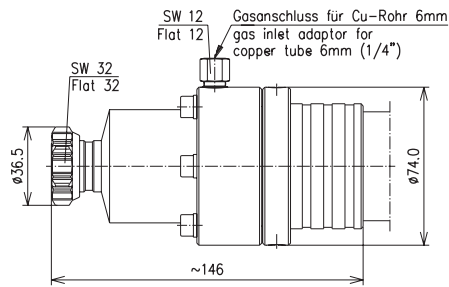

BN 74 14 45

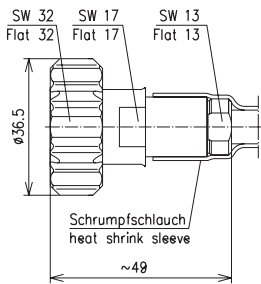

BN 84 73 69

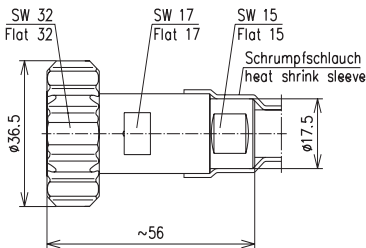

KABELSTECKVERBINDER ■ CABLE CONNECTORS

Kabelstecker – Straight cable plugs



BN 84 73 68

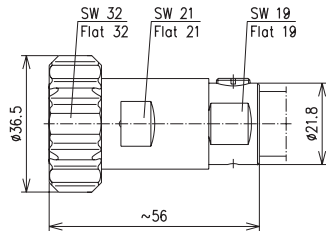

Kabel Typ Cable type	Ausführung Version	Bestell-Nr. Part-No.
LCF12-50	CAF® Plast 2000®	BN 84 73 68
LCF12-50	CAF® O-Ring	BN 84 73 89
LCF/UCF78-50	CAF® Plast 2000®	BN 84 48 40
LCF/UCF78-50	CAF® O-Ring	BN 84 48 41



BN 84 73 89

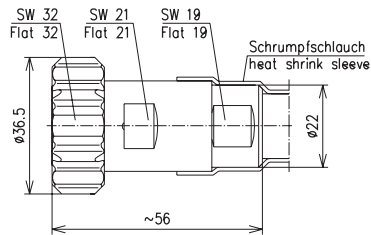

BN 84 48 40

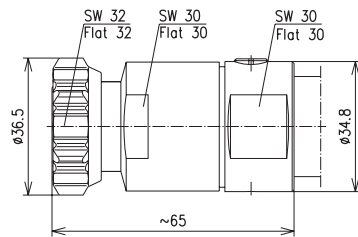

BN 84 48 41

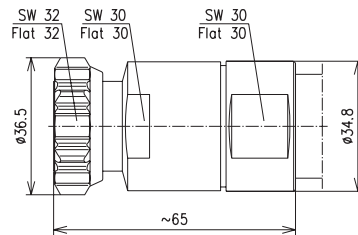

KABELSTECKVERBINDER ■ CABLE CONNECTORS

Kabelstecker – Straight cable plugs



BN 85 43 11

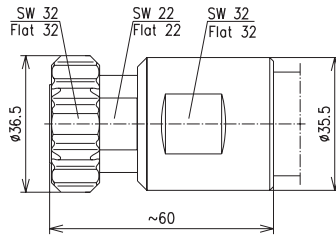

Kabel Typ Cable type	Ausführung Version	Bestell-Nr. Part-No.
LCF/UCF78-50	TOPSPIN® O-Ring	BN 85 43 11
UCF/LCFS114-50	CAF® Plast 2000®	BN 84 48 42
UCF/LCFS114-50	CAF® O-Ring	BN 84 48 43
LCF158-50	CAF® Plast 2000®	BN 84 48 44



BN 84 48 42

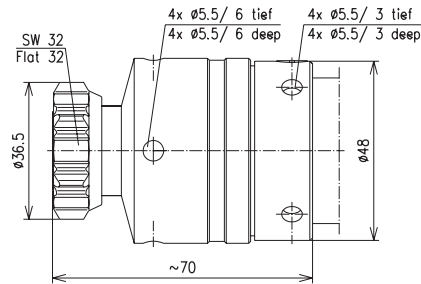

BN 84 48 43

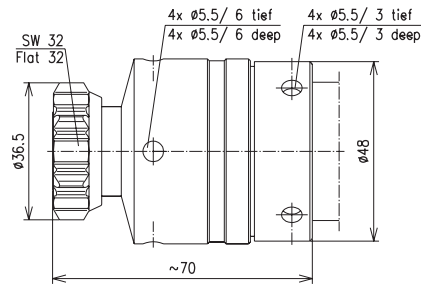

BN 84 48 44

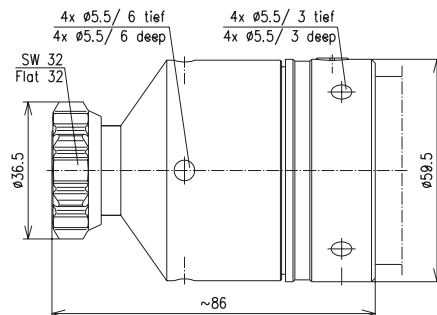

KABELSTECKVERBINDER ■ CABLE CONNECTORS

Kabelstecker – Straight cable plugs



BN 84 48 45

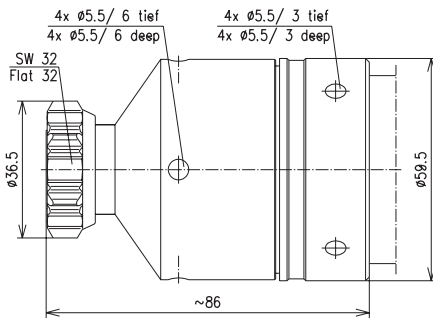

Kabel Typ Cable type	Ausführung Version	Bestell-Nr. Part-No.
LCF158-50	CAF® O-Ring	BN 84 48 45
LCF214-50	CAF® O-Ring	BN 84 48 63
LCF214-50	CAF® Plast 2000®	BN 84 48 73



BN 84 48 63

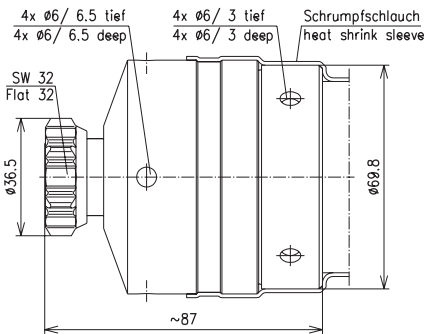

BN 84 48 73

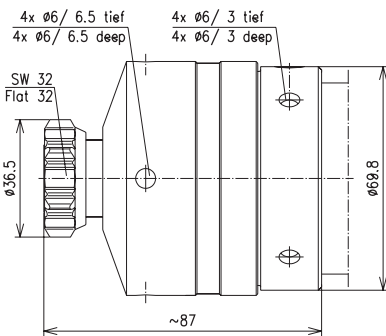

7-16

KABELSTECKVERBINDER ■ CABLE CONNECTORS

Kabelstecker – Straight cable plugs



BN 55 71 12

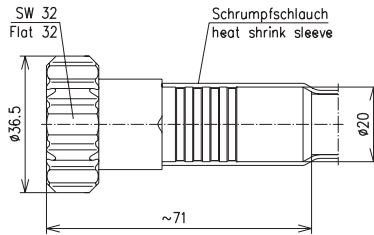

BN 52 71 93

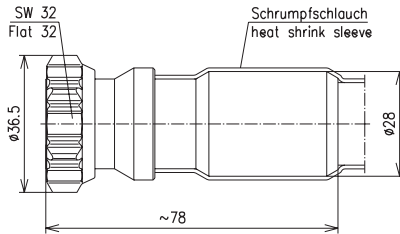

BN 55 71 52

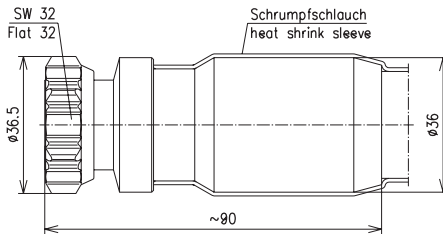

BN 55 71 62

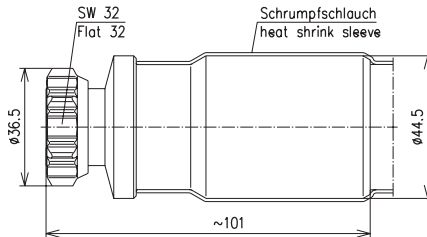

BN 55 71 72

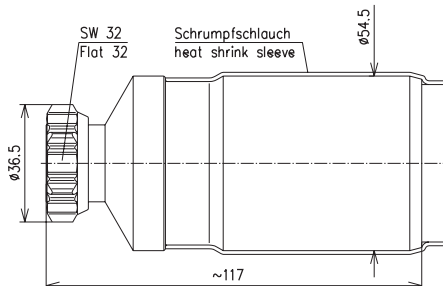

Kabel Typ Cable type	Ausführung Version	Bestell-Nr. Part-No.
RADIAFLEX® 12-50	Schrumpfschlauch Heat shrink sleeve	BN 55 71 12
RADIAFLEX® 58-50	Schrumpfschlauch Heat shrink sleeve	BN 52 71 93
RADIAFLEX® 78-50	Schrumpfschlauch Heat shrink sleeve	BN 55 71 52
RADIAFLEX® 114-50	Schrumpfschlauch Heat shrink sleeve	BN 55 71 62
RADIAFLEX® 158-50	Schrumpfschlauch Heat shrink sleeve	BN 55 71 72

KABELSTECKVERBINDER ■ CABLE CONNECTORS

Kabelwinkelstecker – Right angle cable plugs



BN 94 07 80

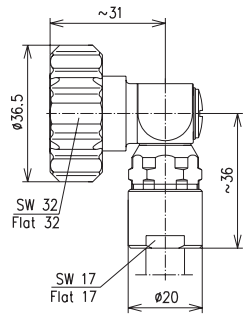

Kabel Typ Cable type	Ausführung Version	Bestell-Nr. Part-No.
RG 213/U	geklemmt clamped	BN 94 07 80
RG 214/U RG 393/U	geklemmt clamped	BN 80 76 80
SCF38-50	CAF® Profildichtung CAF® profile gasket	BN 84 73 73
SCF/UCF12-50	CAF® Profildichtung CAF® profile gasket	BN 84 73 57



BN 80 76 80

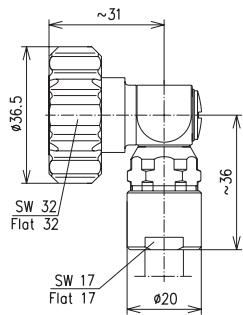

BN 84 73 73

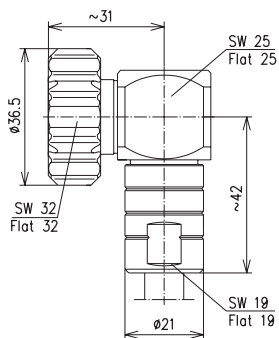

BN 84 73 57

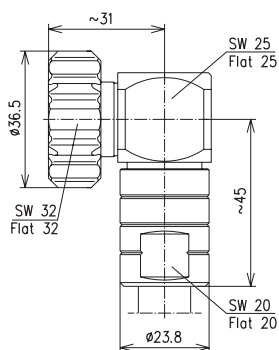

KABELSTECKVERBINDER ■ CABLE CONNECTORS

Kabelwinkelstecker – Right angle cable plugs



BN 84 73 56

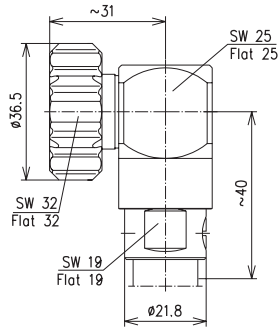

Kabel Typ Cable type	Ausführung Version	Bestell-Nr. Part-No.
LCF12-50	CAF® Plast 2000®	BN 84 73 56
LCF12-50	CAF® O-Ring	BN 84 73 91
LCF/UCF78-50	CAF® Plast 2000®	BN 84 48 50
LCF/UCF78-50	CAF® O-Ring	BN 84 48 51



BN 84 73 91

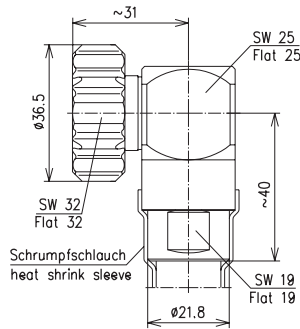

BN 84 48 50

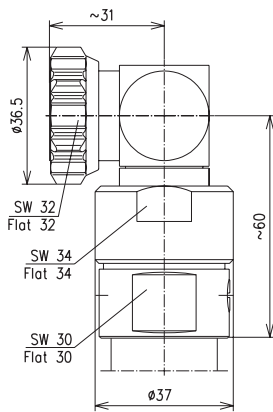

BN 84 48 51

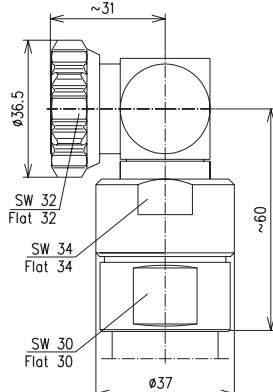

KABELSTECKVERBINDER ■ CABLE CONNECTORS

Kabelkuppler – Straight cable sockets



BN 29 81 20

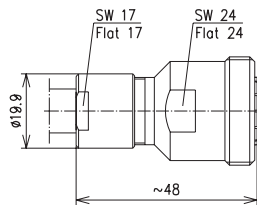

Kabel Typ Cable type	Ausführung Version	Bestell-Nr. Part-No.
RG 213/U	geklemmt clamped	BN 29 81 20
RG 214/U	geklemmt clamped	BN 95 19 20
RG 393/U	geklemmt clamped	BN 95 19 20
RG 214/U	gecrimpt crimped	BN 95 19 22
RG 393/U	gecrimpt crimped	BN 95 19 22
SCF14-50	Schrumpfschlauch Heat shrink sleeve	BN 65 99 60



BN 95 19 20

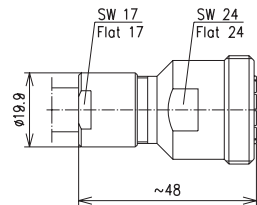

BN 95 19 22

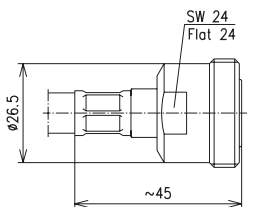

BN 65 99 60

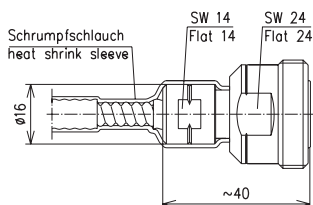

KABELSTECKVERBINDER ■ CABLE CONNECTORS

Kabelkuppler – Straight cable sockets



BN 71 03 39

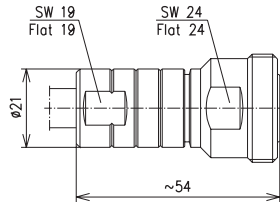

BN 71 03 59

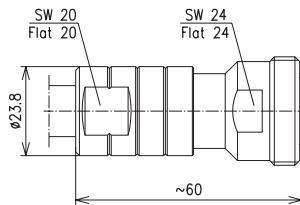

BN 97 07 28

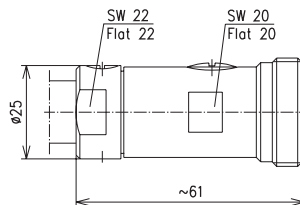

BN 49 90 18

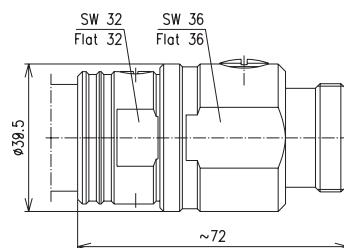

BN 69 07 10

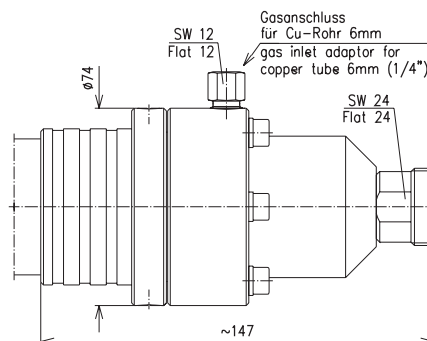

Kabel Typ Cable type	Ausführung Version	Bestell-Nr. Part-No.
SCF38-50	CAF® Profildichtung CAF® profile gasket	BN 71 03 39
SCF/UCF12-50	CAF® Profildichtung CAF® profile gasket	BN 71 03 59
HCA38-50	CAF® Plast 2000®	BN 97 07 28
HCA78-50	CAF® Plast 2000®	BN 49 90 18
HCA158-50	Premium Plast 2000®	BN 69 07 10

KABELSTECKVERBINDER ■ CABLE CONNECTORS

Kabelkuppler – Straight cable sockets



BN 71 03 68

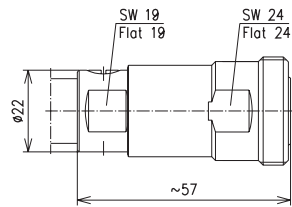

Kabel Typ Cable type	Ausführung Version	Bestell-Nr. Part-No.
LCF12-50	CAF® Plast 2000®	BN 71 03 68
LCF12-50	CAF® O-Ring	BN 71 03 89
LCF/UCF78-50	CAF® Plast 2000®	BN 65 56 40
LCF/UCF78-50	CAF® O-Ring	BN 65 56 41



BN 71 03 89

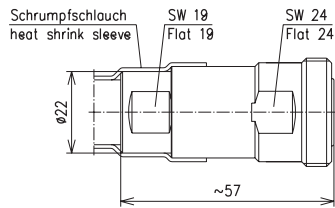

BN 65 56 40

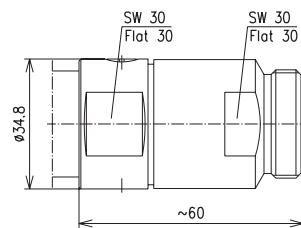

BN 65 56 41

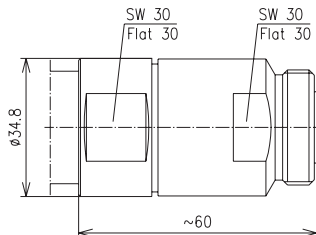

KABELSTECKVERBINDER ■ CABLE CONNECTORS

Kabelkuppler – Straight cable sockets



BN 65 43 11

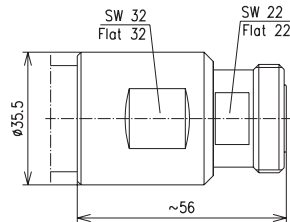

Kabel Typ Cable type	Ausführung Version	Bestell-Nr. Part-No.
LCF/UCF78-50	TOPSPIN® O-Ring	BN 65 43 11
UCF/LCFS114-50	CAF® Plast 2000®	BN 65 56 42
UCF/LCFS114-50	CAF® O-Ring	BN 65 56 43
LCF158-50	CAF® Plast 2000®	BN 65 56 44



BN 65 56 42

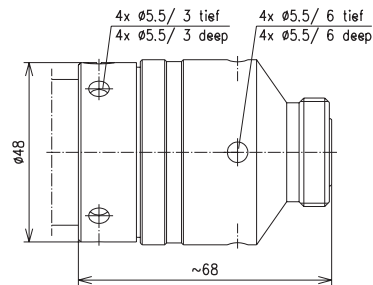

BN 65 56 43

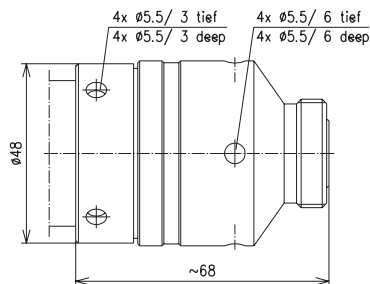

BN 65 56 44

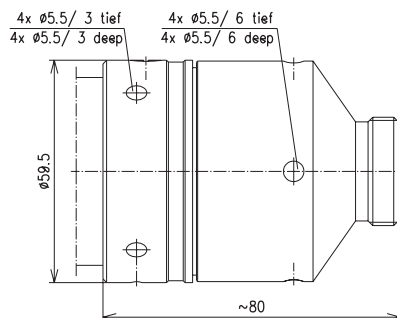

KABELSTECKVERBINDER ■ CABLE CONNECTORS

Kabelkuppler – Straight cable sockets



BN 65 56 45

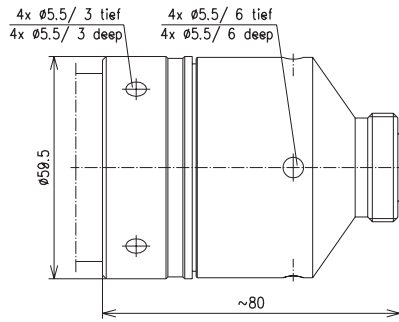

Kabel Typ Cable type	Ausführung Version	Bestell-Nr. Part-No.
LCF158-50	CAF® O-Ring	BN 65 56 45
LCF214-50	CAF® Plast 2000®	BN 65 56 73
LCF214-50	CAF® O-Ring	BN 65 56 63
RADIAFLEX® 12-50	Schrumpfschlauch Heat shrink sleeve	BN 55 71 13



BN 65 56 73

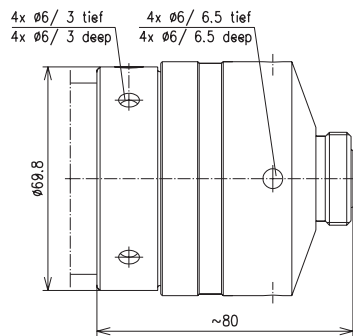

BN 65 56 63

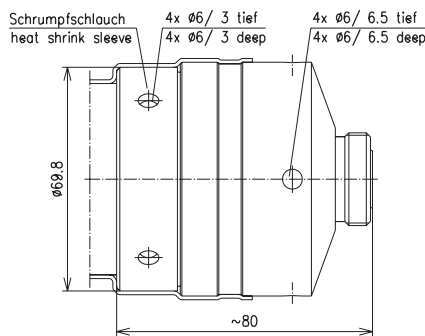

BN 55 71 13

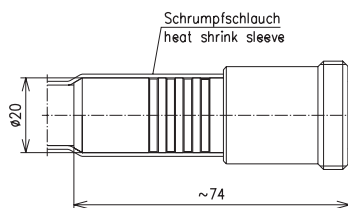

KABELSTECKVERBINDER ■ CABLE CONNECTORS

Kabelkuppler – Straight cable sockets



BN 52 71 94

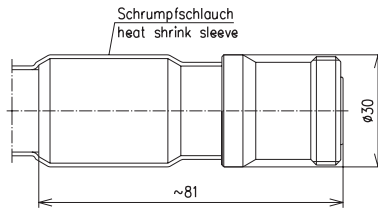

Kabel Typ Cable type	Ausführung Version	Bestell-Nr. Part-No.
RADIAFLEX® 58-50	Schrumpfschlauch Heat shrink sleeve	BN 52 71 94
RADIAFLEX® 78-50	Schrumpfschlauch Heat shrink sleeve	BN 55 71 53
RADIAFLEX® 114-50	Schrumpfschlauch Heat shrink sleeve	BN 55 71 63
RADIAFLEX® 158-50	Schrumpfschlauch Heat shrink sleeve	BN 55 71 73



BN 55 71 53

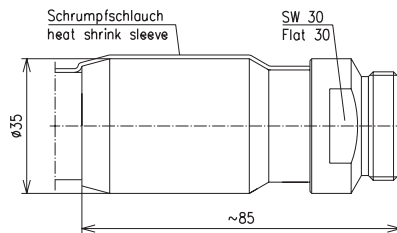

BN 55 71 63

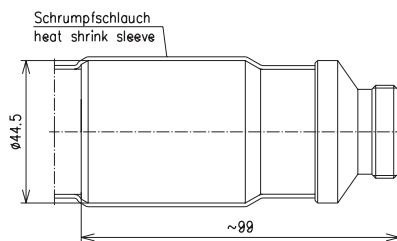

BN 55 71 73

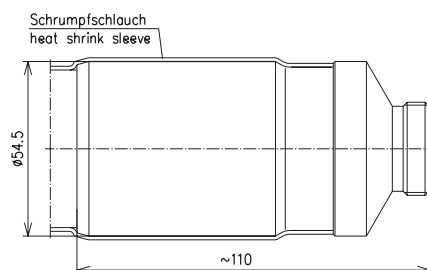

KABELSTECKVERBINDER ■ CABLE CONNECTORS

Gehäusekuppler für Einlochbefestigung – Fixed socket for single hole mounting



BN 80 77 88

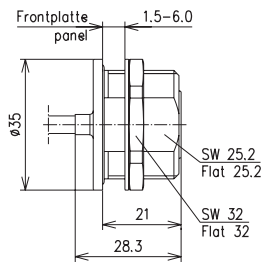

Kabel Typ Cable type	Ausführung Version	Bestell-Nr. Part-No.
RG 402/U Semirigid flexibel 141	gelötet soldered	BN 80 77 88



BN 80 77 33

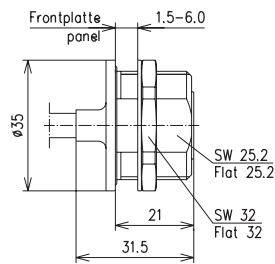

Kabel Typ Cable type	Ausführung Version	Bestell-Nr. Part-No.
RG 401/U	gelötet soldered	BN 80 77 33

Gehäusekuppler mit Viereckflansch – Fixed socket with four hole mounting flange



BN 80 77 50

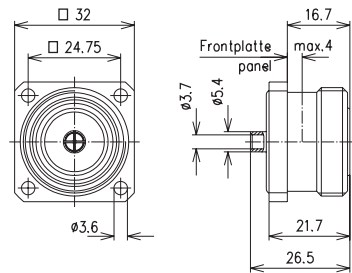

Kabel Typ Cable type	Ausführung Version	Bestell-Nr. Part-No.
RG 402/U Semirigid flexibel 141	gelötet soldered	BN 80 77 50

Abdichtung zum Gehäuse mit O-Ring,
Innenleiter verdrehungsgesichert
Sealing to the panel with O-Ring,
captivated inner conductor



BN 80 77 06

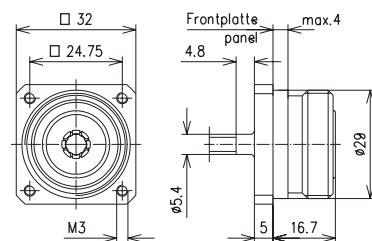

Kabel Typ Cable type	Ausführung Version	Bestell-Nr. Part-No.
RG 402/U Semirigid flexibel 141	gelötet soldered	BN 80 77 06

KABELSTECKVERBINDER ■ CABLE CONNECTORS
Gehäusekuppler mit Viereckflansch – Fixed socket with four hole mounting flange

BN 80 77 60

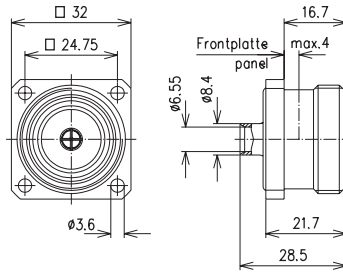

Kabel Typ Cable type	Ausführung Version	Bestell-Nr. Part-No.
RG 401/U	gelötet soldered	BN 80 77 60

Abdichtung zum Gehäuse mit O-Ring,
Innenleiter verdrehungsgesichert
Sealing to the panel with O-Ring,
captivated inner conductor



BN 80 77 86

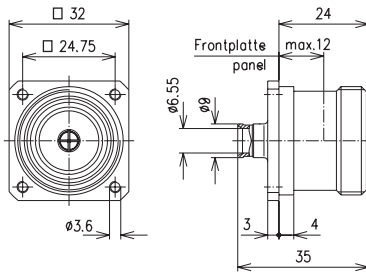

Kabel Typ Cable type	Ausführung Version	Bestell-Nr. Part-No.
RG401/U Semirigid flexibel 250	gelötet soldered	BN 80 77 86



BN 80 77 19

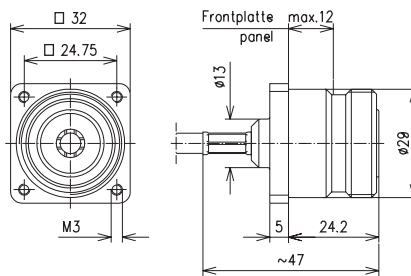

Kabel Typ Cable type	Ausführung Version	Bestell-Nr. Part-No.
RG 223/U	gecrimpt	BN 80 77 19
RG 400/U	crimped	



BN 80 77 18

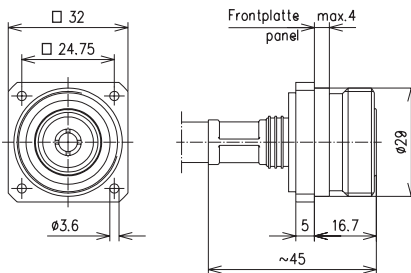

Kabel Typ Cable type	Ausführung Version	Bestell-Nr. Part-No.
RG 393/U	gecrimpt	BN 80 77 18
RG 214/U	crimped	

KABELSTECKVERBINDER ■ CABLE CONNECTORS

Gehäusekuppler mit Viereckflansch – Fixed socket with four hole mounting flange



BN 93 25 00

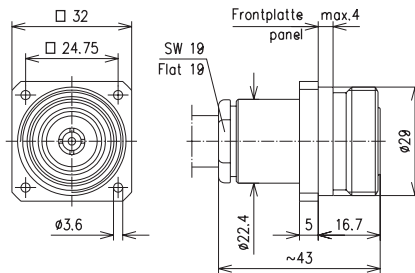

Kabel Typ Cable type	Ausführung Version	Bestell-Nr. Part-No.
RG 217/U	geklemmt clamped	BN 93 25 00

Steckerkopf – Connector head



BN 45 09 95

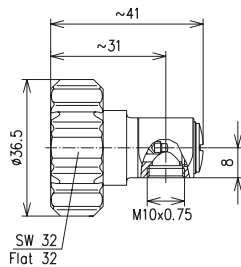

Bestell-Nr. Part-No.	BN 45 09 95
	Kabelabfangungen siehe Seite 77 Cable entries see page 77

GEHÄUSESTECKVERBINDER ■ FIXED CONNECTORS



BN 95 47 16

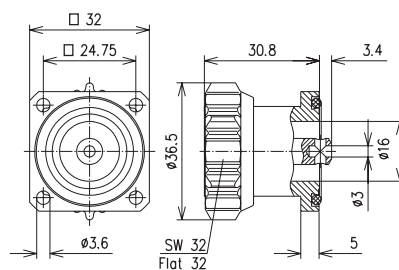

BN 95 47 16

Gehäusestecker mit Viereckflansch
Abdichtung zum Gehäuse mit O-Ring, Innenleiter mit Lötanschluss
Fixed plug with four hole mounting flange, sealing to the panel with O-Ring, inner conductor with soldering connection



BN 95 47 65

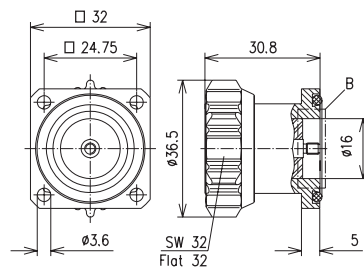

BN 95 47 65

Gehäusestecker mit Viereckflansch
Abdichtung zum Gehäuse mit O-Ring, Innenleiter mit Außengewinde M3
Fixed plug with four hole mounting flange, sealing to the panel with O-Ring, inner conductor with M3 male thread

GEHÄUSESTECKVERBINDER ■ FIXED CONNECTORS

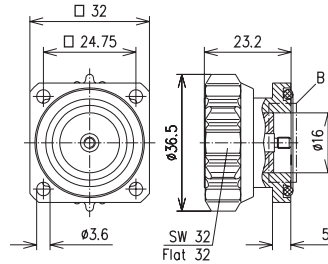
BN 95 48 38

BN 95 48 38

Gehäusestecker mit Viereckflansch
Abdichtung zum Gehäuse mit O-Ring,
Innenleiter verdrehungsgesichert mit
Außengewinde M3

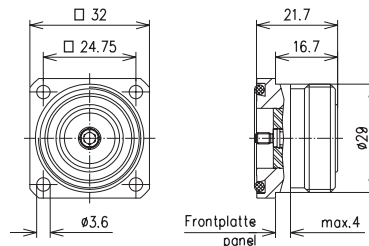
Fixed plug with four hole mounting flange,
sealing to the panel with O-Ring, captivated
inner conductor with M3 male thread

BN 95 46 84

BN 95 46 84

Gehäusekuppler mit Viereckflansch
Abdichtung zum Gehäuse mit O-Ring,
Innenleiter verdrehungsgesichert
mit Außengewinde M3

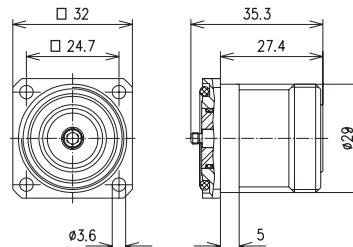
Fixed socket with four hole mounting flange,
sealing to the panel with O-Ring, captivated
inner conductor with M3 male thread

BN 95 46 57

BN 95 46 57

Gehäusekuppler mit Viereckflansch,
längs- und querdicht,
Abdichtung zum Gehäuse mit O-Ring,
Innenleiter mit Außengewinde M3

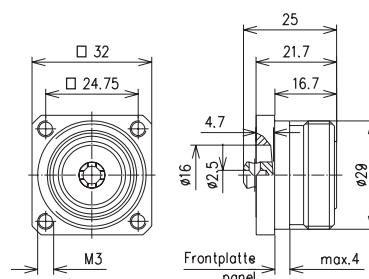
Fixed socket with four hole mounting flange,
mating face and barrier sealed, sealing to
the panel with O-Ring, inner conductor
with M3 male thread

BN 95 45 18

BN 95 45 18

Gehäusekuppler mit Viereckflansch
mit Innenleiter-Lötanschluss (Innenleiter
verdrehungsgesichert)

Fixed socket with four hole mounting flange,
with inner conductor soldering connection
(captivated inner conductor)

GEHÄUSESTECKVERBINDER ■ FIXED CONNECTORS



BN 95 45 10

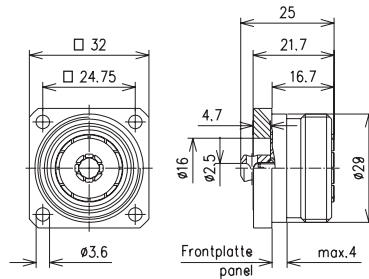

BN 95 45 10

Gehäusekuppler mit Viereckflansch, mit Innenleiter-Lötanschluss (Außenleiterkontaktbuchse geschlitzt)
Fixed socket with four hole mounting flange, with inner conductor soldering connection (with slotted outer conductor)

ZWISCHENSTECKVERBINDER ■ WITHIN-TYPE ADAPTORS



BN 39 33 60

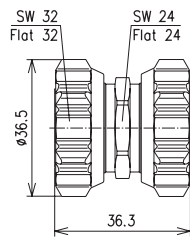

BN 39 33 60

Zwischenstecker
Adaptor, plug-plug



BN 94 47 02

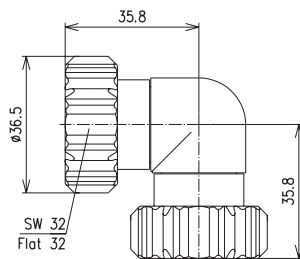

BN 94 47 02

Winkelzwischenstecker
Right angle adaptor, plug-plug



BN 19 64 00

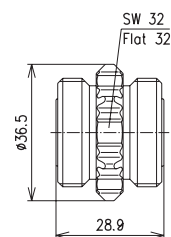

BN 19 64 00

Kupplung
Adaptor, socket-socket

ZWISCHENSTECKVERBINDER ■ WITHIN-TYPE ADAPTORS



BN 92 04 00

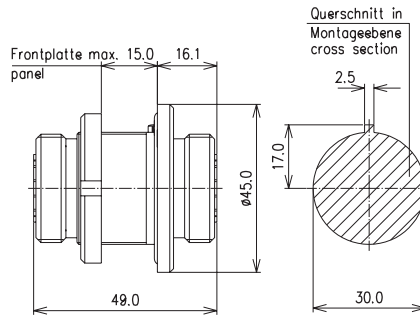

BN 92 04 00

Durchführungskupplung für Einlochmontage (einbau- und längsdicht)
Fixed adaptor, socket-socket for single hole mounting (panel and barrier sealed)



BN 80 84 00

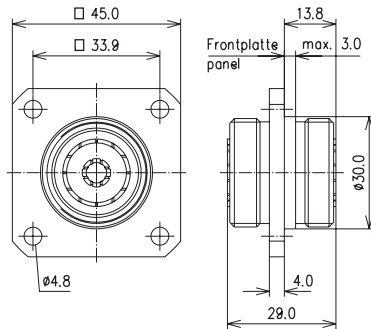

BN 80 84 00

Durchführungskupplung mit Viereckflansch
Fixed adaptor, socket-socket with four hole mounting flange



BN 49 41 10

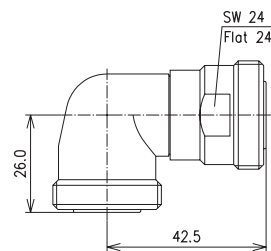

BN 49 41 10

Winkelkupplung
Right angle adaptor, socket-socket



BN 80 86 00

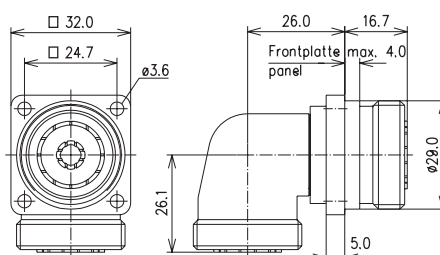

BN 80 86 00

Winkeldurchführungskupplung mit Viereckflansch
Right angle adaptor, socket-socket with four hole mounting flange

ZWISCHENSTECKVERBINDER ■ WITHIN-TYPE ADAPTORS



BN 80 87 00

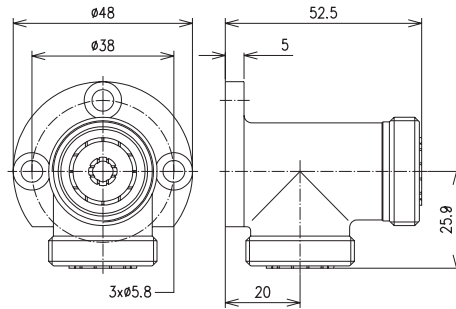

BN 80 87 00

Aufbau Winkelkupplung
Right angle adaptor, socket-socket
with assembly flange



BN 75 64 04

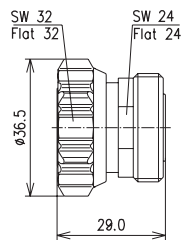

BN 75 64 04

Steckerkupplung
(Schutz für Messanschluss)
Adaptor, plug-socket
(port saver)



BN 29 64 00

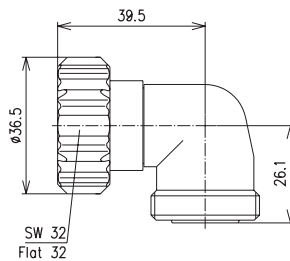

BN 29 64 00

Winkelsteckerkupplung
Right angle adaptor, plug-socket



BN 29 64 01

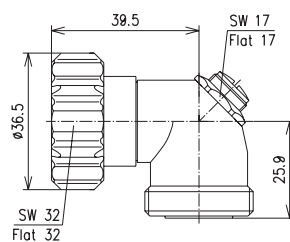

BN 29 64 01

Winkelsteckerkupplung
mit Abgleichschraube
Right angle adaptor, plug-socket
with tuning screw

ZWISCHENSTECKVERBINDER ■ WITHIN-TYPE ADAPTORS



BN 81 81 00

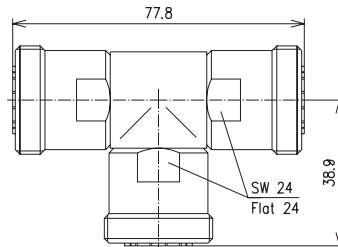

BN 81 81 00
T-Verzweigung,
Kuppler-Kuppler-Kuppler
T-adaptor,
socket-socket-socket



BN 80 64 00

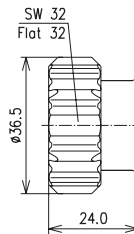

BN 80 64 00
Kurzschluss, Stecker
Short circuit, plug



BN 80 65 00

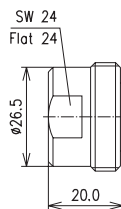

BN 80 65 00
Kurzschluss, Kuppler
Short circuit, socket

SCHUTZKAPPEN ■ PROTECTIVE CAPS



BN 23 90 00

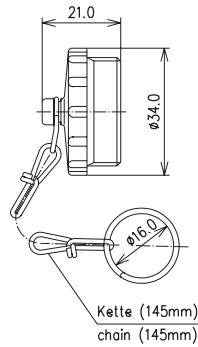

BN 23 90 00
Schutzkappe (Polycarbonat)
mit Kette für Stecker
Protective cap (polycarbonate)
with chain for plugs



BN 23 90 02

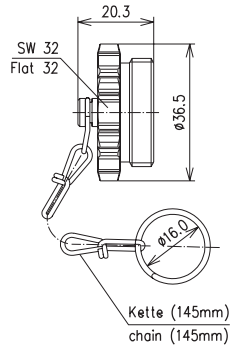

BN 23 90 02
Schutzkappe (Cu-Legierung)
mit Kette für Stecker
Protective cap (copper alloy)
with chain for plugs



BN 23 89 00

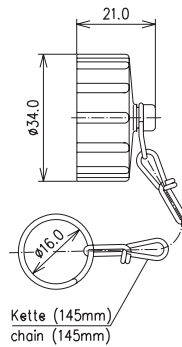

BN 23 89 00
Schutzkappe (Polycarbonat)
mit Kette für Kuppler
Protective cap (polycarbonate)
with chain for sockets



BN 23 89 50

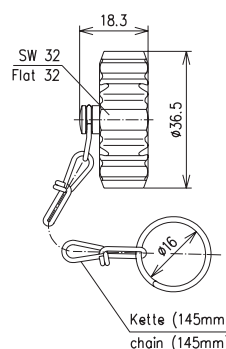

BN 23 89 50
Schutzkappe (Cu-Legierung)
mit Kette für Kuppler
Protective cap (copper alloy)
with chain for sockets

CABLE ENTRIES

Für Kabel von 3 mm bis 7,5 mm Durchmesser über Dielektrikum liefert SPINNER Kabeleinführungen, die mit verschiedenen Steckerköpfe zu geraden Steckverbindern oder Winkelsteckverbindern kombiniert werden können.

Kabeleinführungen und Steckerköpfe bieten wir getrennt an. Die Steckerköpfe sind unter den jeweiligen Steckverbinder-Serien (z.B. 7-16) zu finden.

Alle Kabeleinführungen haben ein Anschlussgewinde M10 x 0,75 (3 mm lang) und können in jeden, beliebigen Steckverbinderkopf von SPINNER geschraubt werden.

For cables from 3 mm up to 7.5 mm diameter of the dielectric SPINNER offers cable entries that can be combined with various connector heads to make straight or angular connectors.

We offer cable entries and connector heads separately. The connector heads are listed under the respective connector series (e. g. 7-16).

All cable entries have a connection thread M10 x 0.75 (3 mm long) and can be screwed into any SPINNER connector head.



BN 41 94 00

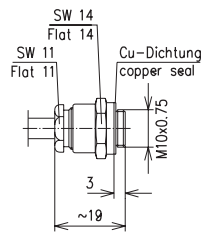

BN 41 95 00

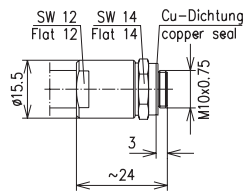

BN 42 01 00 / BN 98 29 00

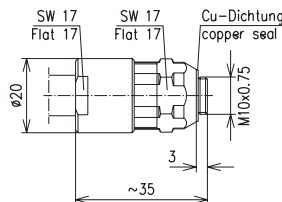

BN 98 29 11

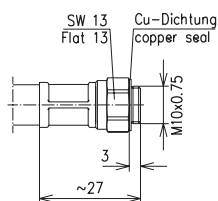

Kabel Typ Cable type	Ausführung Version	Bestell-Nr. Part-No.
RG 55 B/U RG 58 C/U RG 142 B/U RG 223/U RG 400/U	geklemmt clamped	BN 41 94 00
RG 59 B/U	geklemmt clamped	BN 41 95 00
RG 213/U	geklemmt clamped	BN 42 01 00
RG 214/U RG 216/U RG 393/U	geklemmt clamped	BN 98 29 00
RG 214/U RG 393/U	gecrimpt crimped	BN 98 29 11

INTER-TYPE ADAPTORS



Übergangsverbinder dienen zur Verbindung von Koaxanschlüssen unterschiedlicher Steckverbinder-systeme.

Die in diesem Katalog enthaltenen Bestell-Nummern (BN...) geben die häufigsten und wichtigsten Kombinationen an. Nicht enthaltene Kombinationen sind auf Anfrage lieferbar.

Die Angabe Stecker oder Kuppler bezeichnet die jeweilige Ausführung der Anschlüsse des Übergangs-verbinders.

Grundsätzlich werden Übergangsverbinder mit mög-lichst niedrigen Reflexionsfaktoren entwickelt. Präzisions-Übergangsverbinder der HF-Qualitätsstufe 0 können auf Anfrage geliefert werden.

Inter-type adaptors are used to link up the coaxial connections of different connector systems.

The item numbers (BN...) listed in this catalogue include the most common and important combinations.

Combinations not listed here are available upon request.

We specify the items as either plug or socket in order to describe the connector style of the inter-type adaptor.

Basically the inter-type adaptors are designed for lowest possible reflection factors.

Precision inter-type adaptors with RF quality grade 0 are available upon request.

HINWEIS:

Zwischensteckverbinder dienen zur Verbindung von zwei oder mehr Steckverbindern der selben Serie. Sie finden diese unter dem jeweiligen Stecksystem.

NOTE:

Within-type adaptors are used to connect two or more connectors of the same type. They are listed under the respective connector type/series.

INTER-TYPE ADAPTORS

ÜBERGANGSVERBINDER 50 Ω ■ INTER-TYPE ADAPTORS 50 Ω



BN 15 09 08

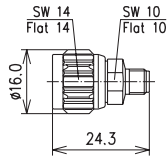

Anschluss 1 Connector 1 TNC	Anschluss 2 Connector 2 SMA	Bestell-Nr. Part-No.
Stecker / plug	Kuppler / socket	BN 15 09 08
Kuppler / socket	Stecker / plug	BN 15 09 07
Kuppler / socket	Kuppler / socket	BN 15 09 06



BN 15 09 07

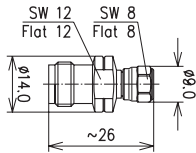

BN 15 09 06

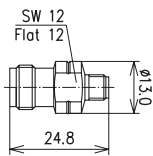

BN 71 21 00

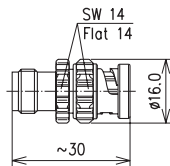

Anschluss 1 Connector 1 TNC	Anschluss 2 Connector 2 BNC	Bestell-Nr. Part-No.
Kuppler / socket	Stecker / plug	BN 71 21 00
Stecker / plug	Kuppler / socket	BN 71 20 00



BN 71 20 00

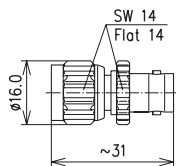

INTER-TYPE ADAPTORS

ÜBERGANGSVERBINDER 50 Ω ■ INTER-TYPE ADAPTORS 50 Ω



BN 72 58 10

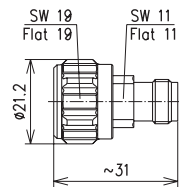

Anschluss 1 Connector 1 N	Anschluss 2 Connector 2 TNC	Bestell-Nr. Part-No.
Stecker / plug	Kuppler / socket	BN 72 58 10
Kuppler / socket	Stecker / plug	BN 72 59 10
Kuppler / socket	Kuppler / socket	BN 72 60 10



BN 72 59 10

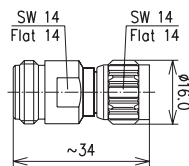

BN 72 60 10

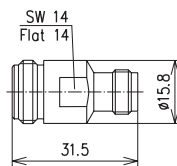

BN 99 94 10

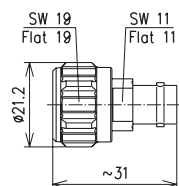

Anschluss 1 Connector 1 N	Anschluss 2 Connector 2 BNC	Bestell-Nr. Part-No.
Stecker / plug	Kuppler / socket	BN 99 94 10
Kuppler / socket	Stecker / plug	BN 99 95 10
Kuppler / socket	Kuppler / socket	BN 99 96 10



BN 99 95 10

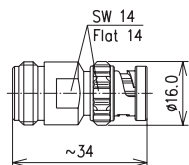

BN 99 96 10

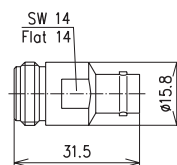

INTER-TYPE ADAPTORS

ÜBERGANGSVERBINDER 50 Ω ■ INTER-TYPE ADAPTORS 50 Ω



BN 87 54 00

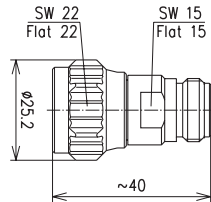

Anschluss 1 Connector 1 HN	Anschluss 2 Connector 2 N	Bestell-Nr. Part-No.
Stecker / plug	Kuppler / socket	BN 87 54 00



BN 95 52 50

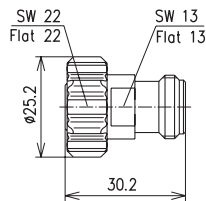

Anschluss 1 Connector 1 4,1-9,5	Anschluss 2 Connector 2 N	Bestell-Nr. Part-No.
Stecker / plug	Kuppler / socket	BN 95 52 50
Kuppler / socket	Kuppler / socket	BN 95 53 50



BN 95 53 50

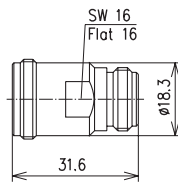

BN 64 95 51

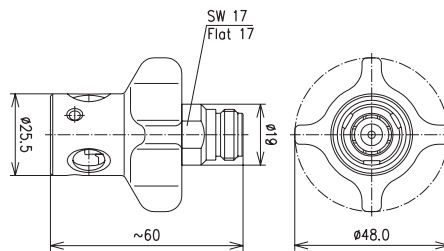

Anschluss 1 Connector 1 4-11	Anschluss 2 Connector 2 N	Bestell-Nr. Part-No.
Stecker / plug	Kuppler / socket	BN 64 95 51
Kuppler / socket	Stecker / plug	BN 64 95 52
Kuppler / socket	Kuppler / socket	BN 64 95 58



BN 64 95 52

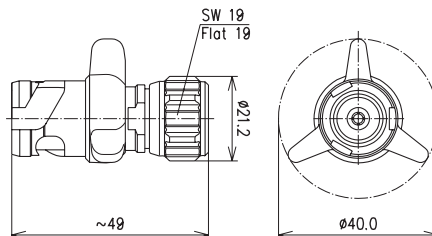

HINWEIS/NOTE:

Die Serie 4-11 ist für extreme Anwendungen, speziell im Feldbereich, hervorragend geeignet. Das Stecksystem ist längs- und querdicht.

Type 4-11 is well suited for extreme applications, especially in the field. The system is barrier and mating face sealed.



BN 64 95 58

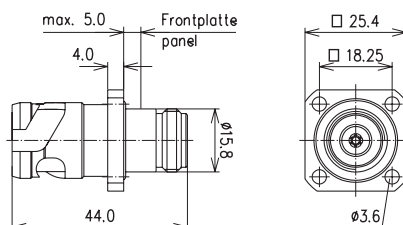

INTER-TYPE ADAPTORS

ÜBERGANGSVERBINDER 50 Ω ■ INTER-TYPE ADAPTORS 50 Ω



BN 29 38 00

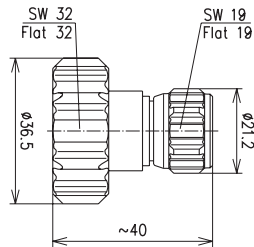

BN 19 44 00

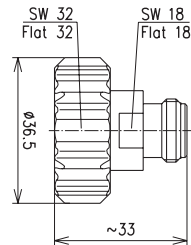

BN 29 39 00

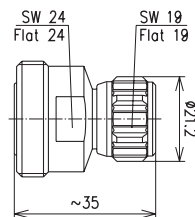

BN 29 40 00

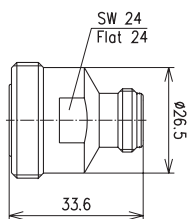

Anschluss 1 Connector 1 7-16	Anschluss 2 Connector 2 N	Bestell-Nr. Part-No.
Stecker / plug	Stecker / plug	BN 29 38 00
Stecker / plug	Kuppler / socket	BN 19 44 00
Kuppler / socket	Stecker / plug	BN 29 39 00
Kuppler / socket	Kuppler / socket	BN 29 40 00

WINKELÜBERGANGSVERBINDER 50 Ω ■ RIGHT ANGLE INTER-TYPE ADAPTORS 50 Ω



BN 72 38 50

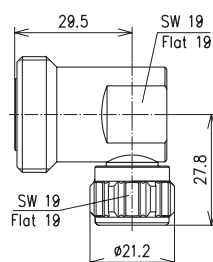

Anschluss 1 Connector 1 7-16	Anschluss 2 Connector 2 N	Bestell-Nr. Part-No.
Kuppler / socket	Stecker / plug	BN 72 38 50

ÜBERGANGSVERBINDER 75 Ω ■ INTER-TYPE ADAPTORS 75 Ω



BN 88 85 00

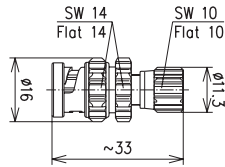

BN 88 87 00

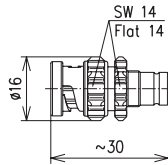

BN 88 84 00

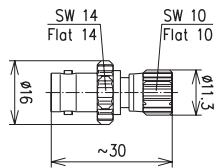

BN 88 86 00

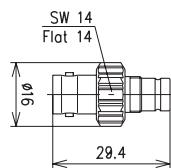

Anschluss 1 Connector 1 BNC	Anschluss 2 Connector 2 1,6-5,6	Bestell-Nr. Part-No.
Stecker / plug	Stecker / plug	BN 88 85 00
Stecker / plug	Kuppler / socket	BN 88 87 00
Kuppler / socket	Stecker / plug	BN 88 84 00
Kuppler / socket	Kuppler / socket	BN 88 86 00

INTER-TYPE ADAPTORS

ÜBERGANGSVERBINDER 75 Ω ■ INTER-TYPE ADAPTORS 75 Ω



BN 52 67 50

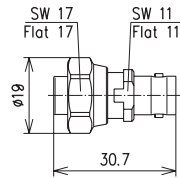

Anschluss 2 Connector 2 3-8	Anschluss 1 Connector 1 BNC	Bestell-Nr. Part-No.
Stecker / plug	Kuppler / socket	BN 52 67 50



BN 52 67 64

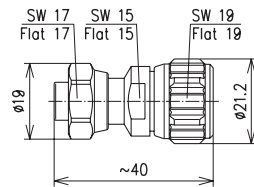

Anschluss 2 Connector 2 3-8	Anschluss 1 Connector 1 N	Bestell-Nr. Part-No.
Stecker / plug	Stecker / plug	BN 52 67 64
Kuppler / socket	Stecker / plug	BN 52 67 65
Stecker / plug	Kuppler / socket	BN 52 67 62
Kuppler / socket	Kuppler / socket	BN 52 67 63



BN 52 67 65

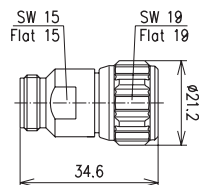

BN 52 67 62

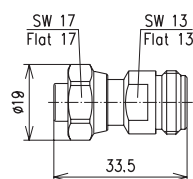

BN 52 67 63

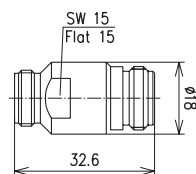

PLAST 2000®

- Garantiert eine absolut einwandfreie Abdichtung zwischen Steckverbinder und Kabel
 - Optimaler Korrosionsschutz der Außenleiterkontaktstelle zwischen Kabel und Steckverbinder
 - 20 cm³ Tube kann direkt in die Kabelabfangung eingeschraubt werden
 - Bei Verwendung der 70 cm³ Tube ist die Einspritzpresse BN 07 05 51 erforderlich
-
- guarantees an absolutely perfect sealing function between connector and cable
 - optimum corrosion protection of the outer conductor contact zone between cable and connector
 - the 20 cm³ tube can be screwed directly into the cable strain relief
 - for 70 cm³ tubes injection gun BN 07 05 51 is required

Kabel Typ Cable type	Füllmenge* Filling quantity*
LCF12-50	4 cm ³
LCF58-50	6 cm ³
LCF78-50	7 cm ³
UCF/LCFS114-50	15 cm ³
LCF158-50	20 cm ³
LCF214-50	28 cm ³
HCA38-50	5 cm ³
HCA58-50	5 cm ³
HCA78-50	5 cm ³
HCA118-50	10 cm ³
HCA158-50	20 cm ³
HCA295-50	50 cm ³
HCA318-50	70 cm ³
HCA418-50	120 cm ³
HC500-50	250 cm ³
HCA618-50	300 cm ³

* je Steckverbinder Ausführung PLAST® 2000
per connector in PLAST® 2000 version

Bauteil Part	Bestell-Nr. Part-No.
20 cm ³ Tube	BN 15 16 71
70 cm ³ Tube	BN 15 05 97
Einspritzpresse mit Gewinde M9 Injection gun with M9 thread	BN 07 05 51

TOOLS AND ACCESSORIES

ABSETZWERKZEUGE ■ TRIMMING TOOLS



- für Kupfer-Wellrohrkabel
- Reduzierung der Montagezeiten um über 60%
- erhebliche Senkung der Montagekosten
- gleichbleibende Montagequalität
- for copper corrugated cables
- assembly time cut by more than 60%
- considerable reduction of assembly costs
- constant assembly quality

Kabel Typ Cable type	Bestell-Nr. Part-No.
SCF14-50	BN 54 13 28
SCF38-50	BN 54 13 35
SCF/UCF12-50	BN 54 13 34
LCF14-50	BN 54 13 20
LCF38-50	BN 54 13 38
LCF12-50	BN 54 13 17
LCF/UCF78-50A	BN 54 13 18
LCF/UCF78-50A	BN 54 13 08 ***
LCFS/UCF114-50A	BN 54 13 36*
LCF158-50A	
RADIAFLEX® 114-50	
RADIAFLEX® 114-75	
RADIAFLEX® 158- 50	BN 54 13 43 **
UCF114-50A	
LCF158-50A	
LCF214-50A	BN 54 13 40
HCA38-50	
HCA58-50	
HCA78-50	BN 54 13 42

* schwere Ausführung mit Kurbel / heavy duty type with crank

** einfache Ausführung mit Kurbel / economy type with crank

*** für TOPSPIN® Steckverbinder / for TOPSPIN® connectors

BÖRDELGERÄTE UND EINSÄTZE ■ FLARING TOOLS AND INSERTS



- für lufttraumisierte Kupfer-Wellrohrkabel
- bestmöglicher HF-Kontakt zwischen Kabel und Steckverbinder
- Basisgerät verwendbar für mehrere Kabeltypen durch zusätzliche Einsätze

Kabel Typ Cable type	Bördelgeräte Flaring tools Bestell-Nr./Part-No.	Einsätze Inserts Bestell-Nr./Part-No.
HCA58-50	BN 51 14 13	BN 51 14 85
HCA78-50		BN 51 14 84
HCA118-50		BN 51 14 70
HCA158-50		not necessary
HCA118-50	BN 51 14 11	BN 51 14 47
HCA158-50		BN 51 14 57
HCA215-50		BN 51 15 20
HCA295-50		BN 51 14 81
HCA318-50		not necessary

- for air dielectric corrugated copper cables
- optimal RF contact between cable and connector
- basic tool usable for different cables with additional inserts

CRIMPZANGE UND EINSÄTZE ■ CRIMPING TOOL AND DIES



Kabel Typ Cable type	Crimpzange ohne Einsatz Crimping tool without die Bestell-Nr./Part-No.	Matrizeneinsatz Crimping die Bestell-Nr./Part-No.
RG 58 C/U RG 223/U RG 400/U 0.4/2.4 2YCY 0.4/2.4 2YCCY	BN 15 07 74	BN 15 07 75
RG 59 B/U RG 174 A/U RG 179 B/U RG 187/U RG 188 A/U RG 316/U		BN 15 17 04
RG 213/U RG 214/U		BN 15 32 45
		BN 15 07 76

Bestell-Nr. Part-No.	Seite Page	Bestell-Nr. Part-No.	Seite Page	Bestell-Nr. Part-No.	Seite Page
BN 07 05 51	85	BN 45 03 40	48	BN 54 13 40	86
BN 15 04 19	23	BN 45 03 68	48	BN 54 13 41	86
BN 15 05 97	85	BN 45 06 90	49	BN 54 13 42	86
BN 15 07 74	87	BN 45 09 30	15	BN 54 13 43	86
BN 15 07 75	87	BN 45 09 35	21	BN 55 71 10	32
BN 15 07 76	87	BN 45 09 40	42	BN 55 71 11	40
BN 15 09 06	79	BN 45 09 95	70	BN 55 71 12	59
BN 15 09 07	79	BN 49 17 18	37	BN 55 71 13	66
BN 15 09 08	79	BN 49 18 18	55	BN 55 71 50	32
BN 15 16 71	85	BN 49 21 18	28	BN 55 71 51	40
BN 15 17 04	87	BN 49 41 10	73	BN 55 71 52	59
BN 15 32 45	87	BN 49 90 18	63	BN 55 71 53	67
BN 19 44 00	82	BN 51 14 11	86	BN 55 71 60	32
BN 19 59 20	52	BN 51 14 13	86	BN 55 71 61	40
BN 19 64 00	72	BN 51 14 47	86	BN 55 71 62	59
BN 23 89 00	76	BN 51 14 57	86	BN 55 71 63	67
BN 23 89 50	76	BN 51 14 70	86	BN 55 71 70	32
BN 23 90 00	76	BN 51 14 81	86	BN 55 71 71	40
BN 23 90 02	76	BN 51 14 84	86	BN 55 71 72	59
BN 29 05 70	42	BN 51 14 85	86	BN 55 71 73	67
BN 29 08 00	16	BN 51 15 20	86	BN 59 06 00	53
BN 29 27 50	16	BN 52 67 50	84	BN 59 09 02	17
BN 29 36 50	43	BN 52 67 62	84	BN 59 17 00	17
BN 29 37 50	43	BN 52 67 63	84	BN 59 18 00	17
BN 29 38 00	82	BN 52 67 64	84	BN 59 45 00	17
BN 29 39 00	82	BN 52 67 65	84	BN 64 43 11	65
BN 29 40 00	82	BN 52 71 91	32	BN 64 95 51	81
BN 29 63 00	45	BN 52 71 92	40	BN 64 95 52	81
BN 29 64 00	74	BN 52 71 93	59	BN 64 95 58	81
BN 29 64 01	74	BN 52 71 94	67	BN 65 56 40	64
BN 29 66 50	26	BN 54 13 08	86	BN 65 56 41	64
BN 29 81 20	62	BN 54 13 17	86	BN 65 56 42	65
BN 29 82 00	42	BN 54 13 18	86	BN 65 56 43	65
BN 29 97 50	44	BN 54 13 20	86	BN 65 56 44	65
BN 39 33 60	72	BN 54 13 34	86	BN 65 56 45	66
BN 41 94 00	77	BN 54 13 35	86	BN 65 56 63	66
BN 41 95 00	77	BN 54 13 36	86	BN 65 56 73	66
BN 42 01 00	77	BN 54 13 38	86	BN 65 99 60	62

Bestell-Nr. Part-No.	Seite Page	Bestell-Nr. Part-No.	Seite Page	Bestell-Nr. Part-No.	Seite Page
BN 67 16 69.....	29	BN 73 90 01.....	14	BN 84 47 55.....	29
BN 67 36 05.....	11	BN 73 90 02.....	20	BN 84 47 60.....	27
BN 67 71 07.....	10	BN 74 06 00.....	16	BN 84 48 40.....	56
BN 67 71 12.....	11	BN 74 06 02.....	16	BN 84 48 41.....	56
BN 68 92 00.....	26	BN 74 08 03.....	45	BN 84 48 42.....	57
BN 69 06 10.....	55	BN 74 08 72.....	26	BN 84 48 43.....	57
BN 69 07 10.....	63	BN 74 08 79.....	26	BN 84 48 44.....	57
BN 69 12 50.....	14	BN 74 14 45.....	55	BN 84 48 45.....	58
BN 69 20 02.....	14	BN 74 14 60.....	53	BN 84 48 50.....	61
BN 69 20 08.....	15	BN 74 56 12.....	21	BN 84 48 51.....	61
BN 69 20 09.....	15	BN 74 61 01.....	22	BN 84 48 63.....	58
BN 70 67 11.....	30	BN 74 66 00.....	23	BN 84 48 73.....	58
BN 70 67 40.....	30	BN 74 71 00.....	23	BN 84 55 55.....	37
BN 70 67 41.....	30	BN 74 75 44.....	41	BN 84 55 60.....	36
BN 70 67 42.....	31	BN 74 76 45.....	41	BN 84 60 57.....	36
BN 70 67 43.....	31	BN 75 23 50.....	44	BN 84 60 63.....	36
BN 70 67 44.....	31	BN 75 64 04.....	74	BN 84 60 68.....	37
BN 70 67 45.....	31	BN 75 78 55.....	34	BN 84 60 69.....	37
BN 70 82 50.....	43	BN 75 78 60.....	34	BN 84 60 89.....	38
BN 71 03 39.....	63	BN 77 80 00.....	10	BN 84 63 11.....	38
BN 71 03 59.....	63	BN 78 97 45.....	30	BN 84 63 40.....	38
BN 71 03 68.....	64	BN 80 64 00.....	75	BN 84 63 41.....	38
BN 71 03 89.....	64	BN 80 65 00.....	75	BN 84 63 42.....	39
BN 71 20 00.....	79	BN 80 76 21.....	52	BN 84 63 43.....	39
BN 71 21 00.....	79	BN 80 76 25.....	52	BN 84 63 44.....	39
BN 71 56 00.....	21	BN 80 76 80.....	60	BN 84 63 45.....	39
BN 72 12 80.....	33	BN 80 77 06.....	68	BN 84 73 39.....	54
BN 72 12 82.....	33	BN 80 77 18.....	69	BN 84 73 56.....	61
BN 72 12 83.....	33	BN 80 77 19.....	69	BN 84 73 57.....	60
BN 72 38 50.....	82	BN 80 77 33.....	68	BN 84 73 59.....	54
BN 72 58 10.....	80	BN 80 77 50.....	68	BN 84 73 68.....	56
BN 72 59 10.....	80	BN 80 77 60.....	69	BN 84 73 69.....	55
BN 72 60 10.....	80	BN 80 77 86.....	69	BN 84 73 73.....	60
BN 73 65 16.....	20	BN 80 77 88.....	68	BN 84 73 89.....	56
BN 73 65 68.....	21	BN 80 84 00.....	73	BN 84 73 91.....	61
BN 73 65 87.....	21	BN 80 86 00.....	73	BN 85 43 11.....	57
BN 73 65 88.....	20	BN 80 87 00.....	74	BN 85 98 00.....	44
BN 73 65 90.....	20	BN 81 81 00.....	75	BN 87 01 56.....	34

Bestell-Nr. Part-No.	Seite Page	Bestell-Nr. Part-No.	Seite Page
BN 87 01 57.....	28	BN 94 47 02.....	72
BN 87 01 63.....	28	BN 94 49 50.....	43
BN 87 01 67.....	35	BN 94 49 51.....	44
BN 87 01 68.....	29	BN 94 50 00.....	27
BN 87 01 69.....	29	BN 94 50 60.....	26
BN 87 01 70.....	35	BN 94 50 61.....	33
BN 87 01 87.....	35	BN 95 18 20.....	52
BN 87 01 89.....	29	BN 95 18 22.....	53
BN 87 03 02.....	20	BN 95 19 20.....	62
BN 87 48 50.....	22	BN 95 19 22.....	62
BN 87 54 00.....	81	BN 95 45 10.....	72
BN 88 03 00.....	10	BN 95 45 18.....	71
BN 88 06 00.....	10	BN 95 46 57.....	71
BN 88 54 45.....	38	BN 95 46 84.....	71
BN 88 60 50.....	14	BN 95 47 16.....	70
BN 88 67 00.....	11	BN 95 47 65.....	70
BN 88 68 00.....	11	BN 95 48 38.....	71
BN 88 68 10.....	11	BN 95 52 50.....	81
BN 88 84 00.....	83	BN 95 53 50.....	81
BN 88 85 00.....	83	BN 97 04 18.....	28
BN 88 86 00.....	83	BN 97 05 18.....	36
BN 88 87 00.....	83	BN 97 06 28.....	54
BN 92 04 00.....	73	BN 97 07 28.....	63
BN 92 24 50.....	27	BN 97 98 50.....	41
BN 92 24 75.....	27	BN 98 12 42.....	49
BN 92 25 50.....	36	BN 98 29 00.....	77
BN 92 26 50.....	41	BN 98 29 11.....	77
BN 92 27 00.....	27	BN 99 88 00.....	45
BN 92 53 18.....	28	BN 99 94 10.....	80
BN 92 54 18.....	37	BN 99 95 10.....	80
BN 92 55 25.....	54	BN 99 96 10.....	80
BN 92 91 00.....	17		
BN 93 25 00.....	70		
BN 93 26 00.....	53		
BN 93 36 02.....	15		
BN 93 50 00.....	42		
BN 93 60 00.....	45		
BN 94 07 80.....	60		

VSWR CONVERSION TABLE

VSWR	Reflection (r)	Return loss (dB)
1,010	0,005	46,1
1,015	0,007	42,6
1,020	0,010	40,1
1,025	0,012	38,2
1,030	0,015	36,6
1,035	0,017	35,3
1,040	0,020	34,2
1,045	0,022	33,1
1,050	0,024	32,3
1,055	0,027	31,4
1,060	0,029	30,7
1,065	0,031	30,0
1,070	0,034	29,4
1,075	0,036	28,8
1,080	0,038	28,3
1,085	0,041	27,8
1,090	0,043	27,3
1,095	0,045	26,9
1,100	0,048	26,4
1,110	0,052	25,7
1,120	0,057	24,9
1,130	0,061	24,3
1,140	0,065	23,7
1,150	0,070	23,1
1,160	0,074	22,6
1,170	0,078	22,1
1,180	0,083	21,7
1,190	0,087	21,2
1,200	0,091	20,8
1,210	0,095	20,4
1,220	0,099	20,1
1,230	0,103	19,7
1,240	0,107	19,4
1,250	0,111	19,1
1,260	0,115	18,8
1,270	0,119	18,5
1,280	0,123	18,2
1,290	0,127	17,9
1,300	0,130	17,7
1,310	0,134	17,4
1,320	0,138	17,2
1,330	0,142	17,0
1,340	0,145	16,8
1,350	0,149	16,5
1,360	0,153	16,3
1,370	0,156	16,1
1,380	0,160	15,9
1,390	0,163	15,7
1,400	0,167	15,6
1,410	0,170	15,4
1,420	0,174	15,2

VSWR	Reflection (r)	Return loss (dB)
1,430	0,177	15,0
1,440	0,180	14,9
1,450	0,184	14,7
1,460	0,187	14,6
1,470	0,190	14,4
1,480	0,194	14,3
1,490	0,197	14,1
1,500	0,200	14,0
1,510	0,203	13,8
1,520	0,206	13,7
1,530	0,209	13,6
1,540	0,213	13,4
1,550	0,216	13,3
1,560	0,219	13,2
1,570	0,222	13,1
1,580	0,225	13,0
1,590	0,228	12,8
1,600	0,231	12,7
1,610	0,234	12,6
1,620	0,237	12,5
1,630	0,240	12,4
1,640	0,242	12,3
1,650	0,245	12,2
1,660	0,248	12,1
1,670	0,251	12,0
1,680	0,254	11,9
1,690	0,257	11,8
1,700	0,259	11,7
1,710	0,262	11,6
1,720	0,265	11,5
1,730	0,267	11,5
1,740	0,270	11,4
1,750	0,273	11,3
1,760	0,275	11,2
1,770	0,278	11,1
1,780	0,281	11,0
1,790	0,283	11,0
1,800	0,286	10,9
1,810	0,288	10,8
1,820	0,291	10,7
1,830	0,293	10,7
1,840	0,296	10,6
1,850	0,298	10,5
1,860	0,301	10,4
1,870	0,303	10,4
1,880	0,306	10,3
1,890	0,308	10,2
1,900	0,310	10,2
1,910	0,313	10,1
1,920	0,315	10,0
1,930	0,317	10,0

Auf unserer Webseite finden Sie einen VSWR-Rechner zum Download.
 On our website you will find under downloads a VSWR converter tool.

SPINNER SALES OFFICES

SPINNER ATLANTA, Inc.

4355 International Blvd.
Suite 200
Norcross, GA 30093, USA
tel.: +1 770 2636326 / fax: +1 770 2636329
sales@spinneratl.com
www.spinneratl.com

SPINNER AUSTRIA GMBH

Triester Str. 190
1230 Wien
tel.: +43 1 6627751 / fax: +43 1 662775115
officeaustria@spinner.de

SPINNER ELECTROTÉCNICA S.L.

Avda. de Europa 5,
Portal 3, 2ªA
28224 Pozuelo de Alarcón (Madrid)
tel.: +34 91 7141845 / fax: +34 91 7141847
iker.llona@spinner.de

SPINNER FRANCE S.A.R.L.

1, Place du Village
Parc des Barbanniers
92632 Gennevilliers Cedex
tel.: +33 1 41479600 / fax: +33 1 41479606
spinner-france@spinner.fr

SPINNER ITALIA S.R.L.

Via De Carolis Nr. 44
40133 Bologna
tel.: +39 051 6194064 / fax: +39 051 6183689
spinner-italia@spinner.de

SPINNER SUOMI Oy

Kauniaistentie 7
02700 Kauniainen, Finland
tel.: +358 954760220 / fax: +358 95122144
sales.spinner.suomi@spinner.de

SPINNER SVERIGE AB

Kråketorpsgatan 20
431 53 Mölndal, Sweden
tel.: +46 31 7061670 / fax: +46 31 7061679
sales@spinner.se

SPINNER UNITED KINGDOM Ltd.

Unit 2, Barn Farm
Sibson Road Ratcliffe Culey
Atherstone, Warwickshire
CV9 3PH
tel.: +44 1827 717777 / fax: +44 1827 715161
salesuk@spinmid.co.uk

SPINNER Telecommunication Devices Co., Ltd.

351 Lian Yang Road
Songjiang Industrial Zone
Shanghai
201613 P.R. China
tel.: +86 21 57745377 / fax: +86 21 57740962
salescn@spinner.de

SPINNER GMBH • HEADQUARTERS

Erzgiessereistr. 33 • 80335 München • Germany
tel.: +49 (0) 89 12601-0 • fax: +49 (0) 89 12601-1292 • www.spinner.de

Abbildungen unverbindlich • Konstruktionsänderungen vorbehalten
Figures not binding • Designs subject to modification



Zertifiziert nach DIN EN ISO 9001/14001
in Design/Entwicklung,
Produktion, Montage, Wartung
Umweltmanagement