

**HRS** HIROSE  
ELECTRIC  
CO.,LTD.

# CIRCULAR CONNECTORS

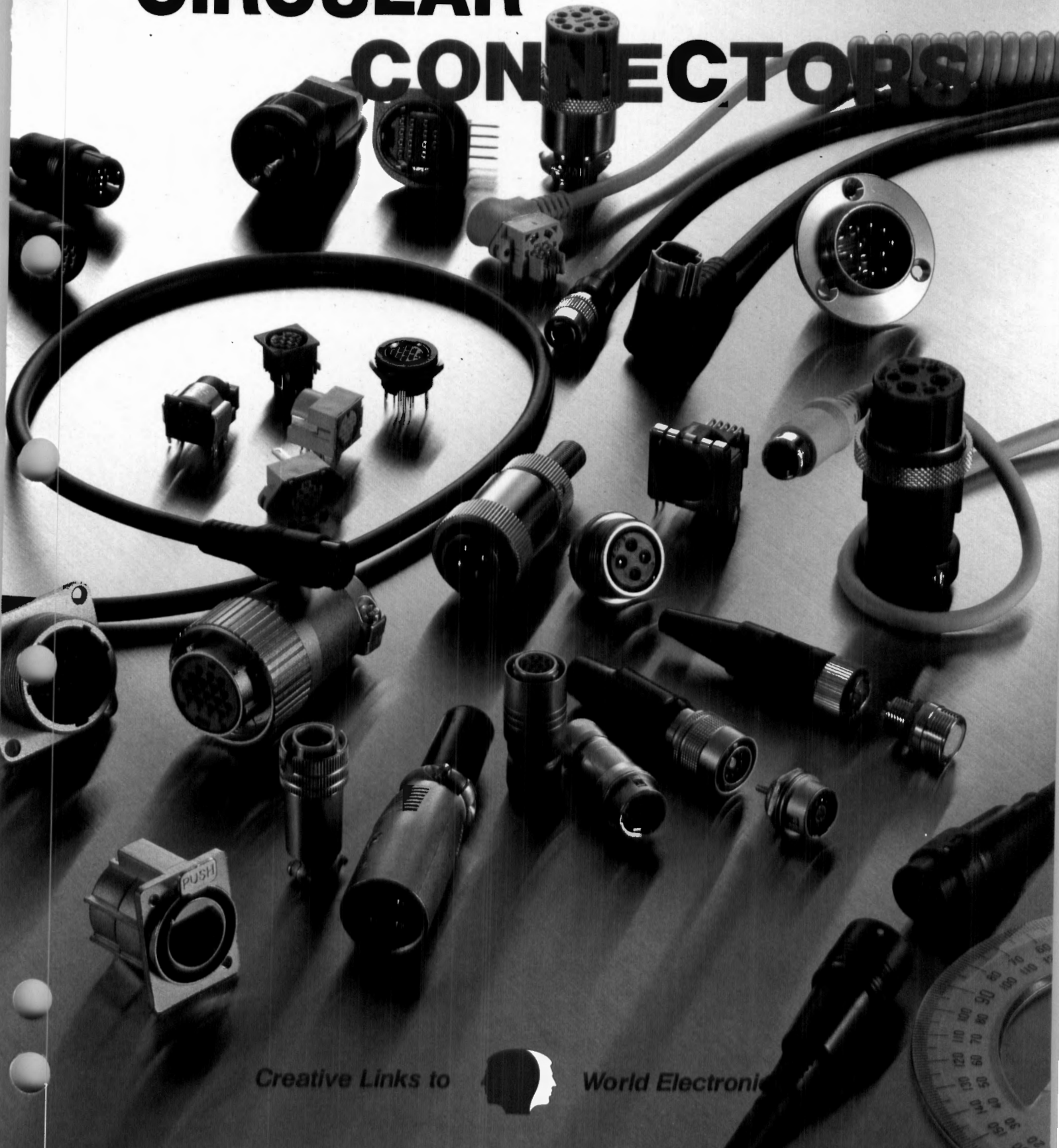

*Creative Links to*

*World Electronics*



# This is HIROSE

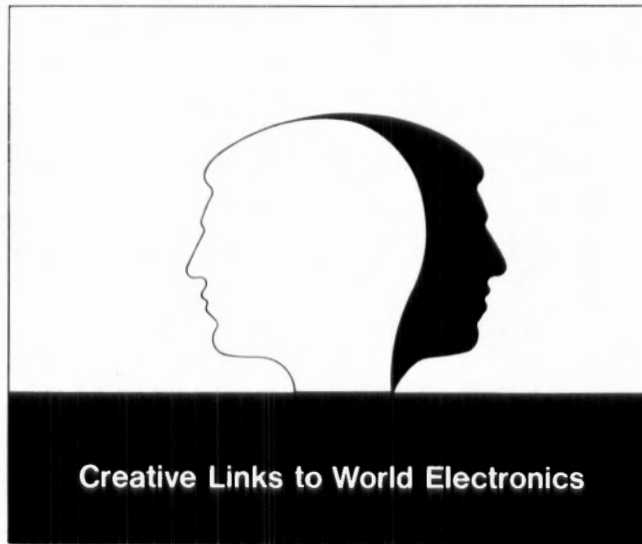

**HRS** has acquired the approval of the ISO 9001 international quality assurance standard.

**HIROSE ELECTRIC CO., LTD. IS A LEADING PRODUCER IN JAPAN OF HIGH QUALITY ELECTRIC/ELECTRONIC CONNECTORS CONNECTING "INTELLIGENCE WITH INTELLIGENCE."**

All **Hirose products** are designed and manufactured under the constant technical guidance of an experienced staff of mechanical, electrical, manufacturing and industrial engineers. People trained in many skills operate advanced assembly and fabrication machinery to provide Hirose customers with the highest quality at reasonable prices.

## OUTLINE OF THE COMPANY

Foundation: 1937  
President: Hideki Sakai  
Capital: 7,376 Million yen (As of June 30, 1994)  
Directors: M. Miura, Y. Saida, T. Nakamura, N. Kawanami, M. Hirohashi, K. Yonebayashi  
Stock Market: Listed in the First Section of Tokyo Stock Exchange Market  
Employees: 1200  
Business lines: Manufacturer of circular connectors, rectangular connectors, printed circuit connectors, coaxial connectors, miniature coaxial connector, IC-sockets, connectors for flat cable and ribbon-cable, microwave components and ME.  
Head Office: 5-23, Osaki 5-chome, Shinagawa-ku, Tokyo, Japan 141 TELEX: J2468237 HRSELE  
Tel. 03(3491)9741 Tele-Fax: Tokyo 3493-2933  
Factories: Ichinoseki Plant (Iwate), Narashino Plant (Chiba)  
Subsidiary: Tohoku Hirose Electric Co., Ltd. (Iwate), Koriyama Hirose Electric Co., Ltd. (Fukushima), Hirose Electric (U.S.A.), Inc. (U.S.A.), Hirose Electric GmbH (Germany), Hirose Electric UK Ltd. (U.K.), Hirose Electric (M) SDN. BHD (Malaysia)  
Joint Venture: Hirose Cherry Precision Co., Ltd. (Tokyo), Hirose Korea Co., Ltd.  
Major bank: The Sumitomo Bank, Ltd.  
references: The Fuji Bank, Ltd.  
The Mitsubishi Bank, Ltd.

## Table of Content

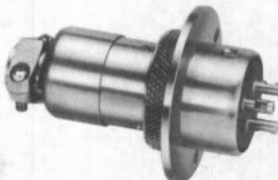
Series	HS				
Description					
Item	Metal receptacle				
Typical product					
Shell size	12	14	16	21	25
Type of shell	P, R, J, RC	P, R, RC	P, R, J, RC	P, R, J, RC	P, R, RC
No. of contacts	2	2	2, 3, 4, 5	2, 3, 4, 5, 6, 7, 8, 10	2, 3, 4, 5, 6, 7, 8, 10
Rated current	7A	7A	7A: 2, 3, 4 2A: 5	10A: 2, 3, 4, 5 7A: 6, 7 4A: 8 3A: 10	10A: 2, 3, 4, 5, 6, 7, 8 4A: 10
Termination	Solder	Solder	Solder	Solder	Solder
Terminal plating	Nickel	Nickel	Nickel	Nickel	Nickel
Accessory	Cap	Cap	Cap	Cap	Cap
Applicable standard			NTT	NTT	NTT
Remarks					
Applicable wire	AWG#16	AWG#16	AWG#16 ~ AWG#14	AWG#20 ~ AWG#13	AWG#20 ~ AWG#13
Reference Catalog pages			8 ~ 17		





**Abbreviations**

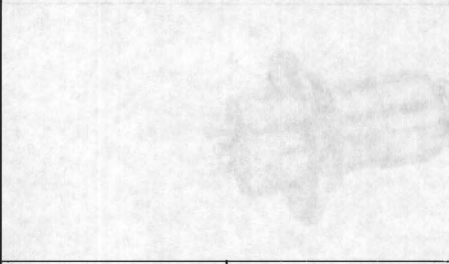
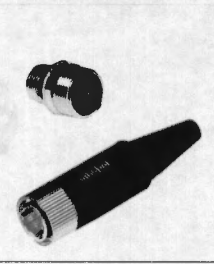
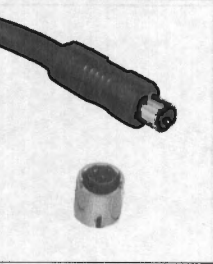
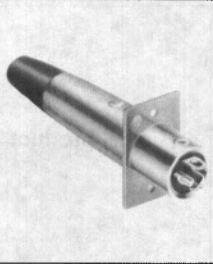

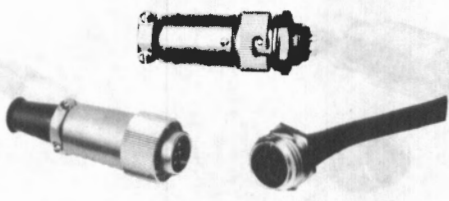
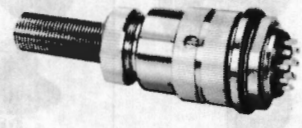
P: Plug    R: Receptacle    RC: Receptacle Cap  
J: Jack

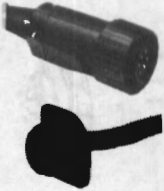
Continued to page 2



Series	HS		SR	SR38	HA
Description					
Items			Microminiature & light weight	Microminiature High-Performance	For microphone
Typical product					
Shell size	28	35	10	4	16
Type of shell	P, R, RC	P, R, RC	P, R, J	P, R	P, R, J, PR
No. of contacts	2, 3, 4, 7, 8, 12	2, 3, 4, 16, 20	4, 6, 7	3	3, 4, 5
Rated current	30A: 2, 3 20A: 4 10A: 7, 8	7A: 4 4A: 12 40A: 2, 3 20A: 4 4A: 16, 20	1A: 4, 6, 7	0.5A	15A: 3 10A: 4 4A: 5 3A: 3 (Dip)
Termination	Solder	Solder except contacts No. 2 and No. 3 for which tab crimp terminals are used.	Solder dip	Solder dip	Solder dip
Terminal plating	Nickel	Nicke	Gold/silver	Silver	Silver
Accessory	Cap	Cap	Clamp, Cap		
Applicable standard					
Remarks			4 - 6P: SR30 Crimping Tool, Terminating Jig		
Applicable wire			AWG#26		
Reference Catalog pages			18 ~ 22	23 ~ 26	28 ~ 42

RM				
RAMICON				
				
12	15	21	24	31
	P, R, J, PC, RC	P, R, J, PC, RC	P, R, J, PC, RC	P, R, J, PC, RC
2, 3, 4, 5, 6, 7	2, 4, 8, 10, 12	15, 20	31	40, 55
5A	10A: 2, 4 5A: 8, 10, 12	5A	5A	5A
Solder	Solder (crimp/dip)	Solder	Solder	Solder
Silver	Silver	Silver	Silver	Silver
	Cap	Cap	Cap	Cap
Dustproof type available, waterproof type available	Dustproof type available, Waterproof available, Automatic crimping machine, Manual crimping tool, Extracting tool	Dustproof type available, waterproof type available	Dustproof type available, waterproof type available	Dustproof type available, waterproof type available
44 ~ 65				

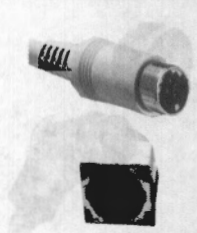
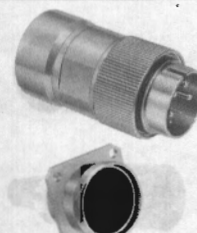
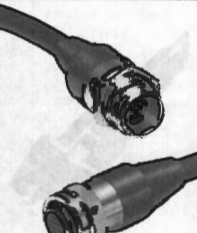
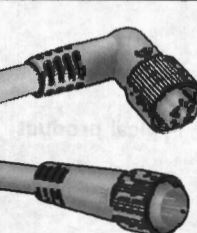
Series	RM		HR10		HR10A, G		
Description							
Item	RM215T, 315T	RM515	Microminiature push-pull (can be locked)				
	RAMICON	RAMICON					
Typical product							
Shell size	15	15	7	10	7	10	13
Type of shell	P, R, J	P, R	P, R, J	P, R, J	P, R, J		
No. of contacts	10	10	4, 6	12	4, 5, 6	10, 12	20
Rated current	5A	5A	2A	2A	2A		
Termination	Crimp/Solder	Crimp/Solder	Solder/Crimp/Dip	Solder/Crimp/Dip	Solder/Crimp/Dip		
Terminal plating	Silver	Silver	Gold	Gold	Silver		
Accessory			Cap	Cap	Cap		
Applicable standard							
Remarks	Automatic crimping machine Manual crimping tool, Extracting tool	Automatic crimping machine, Manual crimping tool, Extracting tool	Terminating Jig	Terminating jig	Terminating jig, Automatic crimping machine, Manual crimping tool, Extracting tool		
Applicable wire							
Reference Catalog pages	66 ~ 72	73 ~ 79	80 ~ 86		87 ~ 114		

HR11	HR12		HR212	HR21	HR22	HR24
<b>BAYONET Lock, Miniature</b>	<b>Plastic</b>		<b>Anti-noise</b>	<b>Water-Proof</b>	<b>High-Performance Compact</b>	<b>For Sensors</b>
						
9	10	14	10	27	12	8
P, R, J	P, R		P, R	P, R	P, R, J	P, PR, R, J
4, 6	5, 8, 10	20	4, 5, 8, 10	6, 17, 27	20	4
2A	1A		5A: 5, 8, 10 1A: 4	5A 1A	2A	3A
Solder	Crimp/Dip		Crimp/Dip	Solder	Crimp/Solder	Solder/Dip
Silver	Tin or selectively gold		Tin or selectively gold	Nickel	Nickel	Silver/Gold
	Stopper plate, Spacer			Clamp Cap		
	Automatic crimping machine, Manual crimping tool, Extracting tool		Automatic crimping machine, Manual crimping tool, Extracting tool		Automatic crimping machine, Manual crimping tool, Extracting tool	
AWG#26						
115 ~ 118	119 ~ 132		133 ~ 145	147 ~ 150	151 ~ 158	159 ~ 172

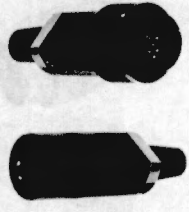
Continued to page 6

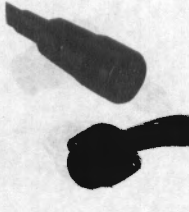
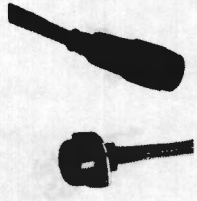
Series	RP					
Description	RP1, RP2, RP9	RP5	RP6		RP13	RP17
Items	Plastics					
Typical product						
Shell size	7, 12	19	10	12	12	13
Type of shell	P, R, RB	P, R, J	P, R		P, R, J	P, R, J
No. of contacts	3, 4, 6, 7	14	5, 8	10	13, 15, 20	12
Rated current	5A: 3, 6, 7 1A: 4	5A	1A		2A	5A (AWG#18~22) 2A (AWG#24~30)
Termination	Solder/Dip	Crimp/Dip	Crimp/Solder/Dip (plug is fitted with cable)		Crimp/Dip	Solder/Dip
Terminal plating	Silver	Silver	Silver		Silver	Silver
Accessory						
Applicable standard						
Remarks		Automatic crimping machine, Manual crimping tool, Extracting tool	Automatic crimping machine, Manual crimping tool, Extracting tool		Antistatic type available, Manual crimping machine, Manual crimping tool, Extracting tool	Antistatic type available, Manual crimping machine, Manual crimping tool, Extracting tool
Applicable wire						
Reference Catalog pages	173 ~ 174	175 ~ 182	183 ~ 188		189 ~ 200	201 ~ 206



RP	JR					H/MS
<b>RP34</b>	<b>JIS C5432 Standard Circular Connectors</b>					<b>Waterproof Type</b>
<b>Plastics</b>						
						
<b>8</b>	<b>13</b>	<b>16</b>	<b>21</b>	<b>25</b>	<b>10, 18, 20, 22, 24</b>	
<b>SP-P-R</b>	<b>PC, PK, RK, JK</b>	<b>RC, PK, RK, JK</b>	<b>RC, PK, RK, JK</b>	<b>RC, PK, RK, JK</b>	<b>P, R</b>	
<b>3</b>	<b>3, 5</b>	<b>7, 10, 14</b>	<b>10, 16, 26</b>	<b>4, 5, 8, 16, 24</b>	<b>2, 3, 4, 6, 7, 8, 17, 19</b>	
<b>3A</b>	<b>10A: 3 5A: 5</b>	<b>10A: 7 5A: 10, 14</b>	<b>10A: 10 5A: 16, 26 5A: 24</b>	<b>30A: 4 10A: 5, 8, 16</b>	<b>13A, 23A, 46A</b>	
<b>Crimp/Dip Solder</b>	<b>Solder</b>	<b>Solder</b>	<b>Crimp/Solder</b>	<b>Crimp/Solder</b>	<b>Solder</b>	
<b>Silver</b>	<b>Silver</b>	<b>Silver</b>	<b>Silver</b>	<b>Silver</b>	<b>Silver-plated</b>	
	<b>Cap</b>	<b>Cap</b>	<b>Cap</b>	<b>Cap</b>		
	<b>JIS</b>	<b>JIS</b>	<b>JIS</b>	<b>JIS</b>	<b>JIS B 6015 MIL-C-5015</b>	
		<b>Bayonet type available</b>	<b>Bayonet type available, Automatic crimping machine, Manual crimping tool, Extracting tool</b>	<b>Waterproof type available, Automatic crimping machine, Manual crimping tool, Extracting tool</b>		
<b>AWG #18 ~ #22</b>						
<b>207 ~ 212</b>	<b>213 ~ 225</b>					<b>227 ~ 237</b>

# HS SERIES SHELL SIZE 12-35mm TRADITIONAL CONNECTORS

## Introduction

HS Series Connectors are generally called metal plug receptacles and are the most popularly used circular multicontact connectors. More than 450 different kinds available, including those designed for special use. Included is a selection of about 150 primary products in the catalogs. HS Series Connectors feature rugged and simple construction,

and are stable in mechanical and electrical performance, complying with the requirements of Nippon Telegraph and Telephone Corporation and other set manufacturers. For performance of each connector in terms of the number of contacts, refer to Contact Arrangements of HS Series on Pages 14-17.

## Material & Finish

Shell	Brass	Nickel plated
Insulator	Synthetic resin	
Pin contact	Brass	Nickel plated
Socket contact	Brass or phosphor bronze	Nickel plated

## Ordering Information

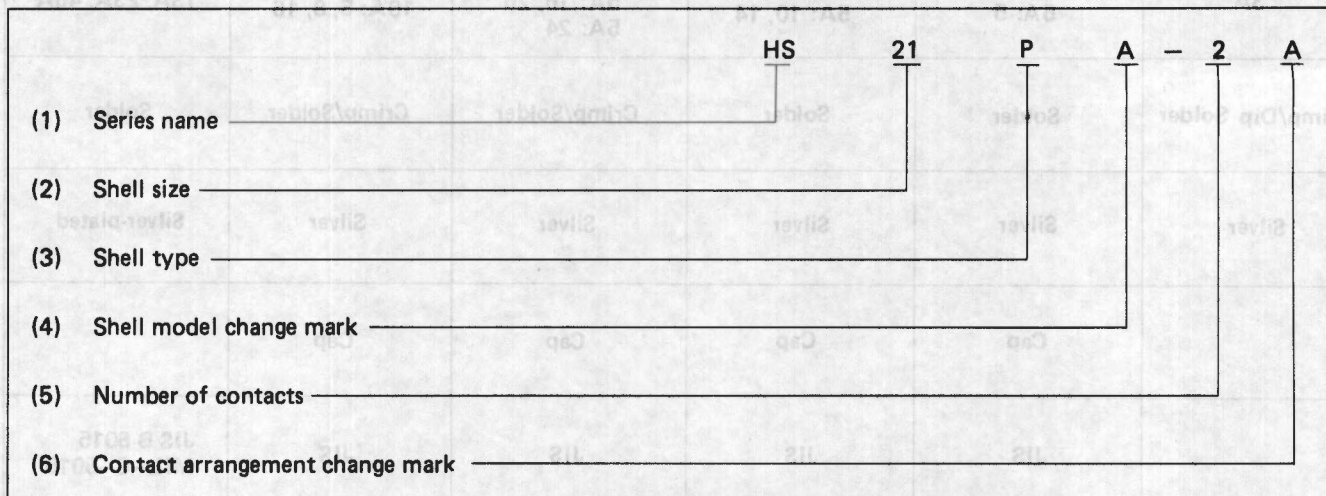

(1) Series name: HS stands for HIROSE STANDARD.

(2) Shell size: The shell size is expressed in outside diameter at plug fitting section (insulator) with seven types; 12, 14, 16, 21, 25, 28 and 35.

(3) Shell type: The shell is classified into the following types.

P : Plug

R : Receptacle

J : Jack

RC : Receptacle cap

(4) Shell model change mark: At each time the shell undergoes a model change, it is marked as A, B or C.

(5) Contact arrangement change mark: When the contact fitting section or contact arrangement undergoes a change, it is marked as A, B, C .... after the number of contacts.

**Cross Reference to NTT**  
**NTT to HRS**

NTT No.	HRS No.		NTT No.	HRS No.	
CN-1602RP	HS16P-2		CN-2104RP	HS21P-4	
CN-1602RJ	HS16R-2		CN-2104RJ	HS21R-4	
CN-1603RP	HS16P-3		CN-2505RP	HS25PB-5A	
CN-1603RJ	HS16R-3		CN-2505RJ	HS25R-5A	
CN-1604RP	HS16P-4		CN-2506RP	HS25PB-6	
CN-1604RJ	HS16R-4		CN-2506RJ	HS25R-6	
CN-2102RP	HS21P-2		CN-2507RP	HS25PB-7	
CN-2102RJ	HS21R-2		CN-2507RJ	HS25R-7	
CN-2103RP	HS21P-3				
CN-2103RJ	HS21R-3				

Note: NTT stands for Nippon Telegraph and Telephone Corporation.

# Plug

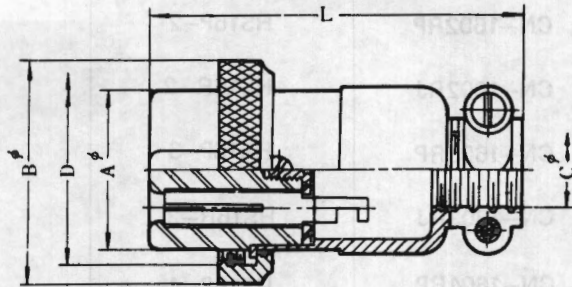
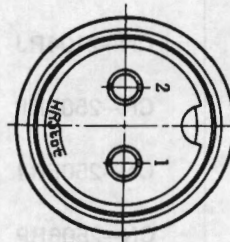

Part No.	A $\phi$	B $\phi$	C $\phi$	D	L
HS12P-2	12	18	7	15.5 <sup>P=1</sup>	38
HS14P-2	13.5	21.5	8.5	19 <sup>P=1</sup>	43
HS16P-2	15.5	21.5	8.5	19 <sup>P=1</sup>	43
HS16P-3	15.5	21.5	8.5	19 <sup>P=1</sup>	43
HS16P-4	15.5	21.5	8.5	19 <sup>P=1</sup>	43
HS16P-5	15.5	21.5	8.5	19 <sup>P=1</sup>	43
HS21P-2	21	28	10	25 <sup>P=1</sup>	50
HS21P-3	21	28	10	25 <sup>P=1</sup>	50
HS21P-4	21	28	10	25 <sup>P=1</sup>	50
HS21P-5	21	28	10	25 <sup>P=1</sup>	50
HS21P-6	21	28	10	25 <sup>P=1</sup>	50
HS21P-7	21	28	10	25 <sup>P=1</sup>	50
HS21P-8	21	28	10	25 <sup>P=1</sup>	50
HS21P-10	21	28	10	25 <sup>P=1</sup>	50
HS25P-2	25	32	10	29 <sup>P=1</sup>	54.5
HS25P-3	25	32	10	29 <sup>P=1</sup>	54.5
HS25P-4	25	32	10	29 <sup>P=1</sup>	54.5
HS25P-5	25	32	10	29 <sup>P=1</sup>	54.5
HS25PB-5A	25	32	10	29 <sup>P=1</sup>	70
HS25PM-5A	25	32	14.5	29 <sup>P=1</sup>	54.5

Part No.	A $\phi$	B $\phi$	C $\phi$	D	L
HS25P-6	25	32	10	29 <sup>P=1</sup>	54.5
HS25PB-6	25	32	10	29 <sup>P=1</sup>	70
HS25P-7	25	32	10	29 <sup>P=1</sup>	54.5
HS25PB-7	25	32	10	29 <sup>P=1</sup>	70
HS25PM-7	25	32	14.5	29 <sup>P=1</sup>	54.5
HS25P-8	25	32	10	29 <sup>P=1</sup>	54.5
HS25P-10	25	32	10	29 <sup>P=1</sup>	54.5
HS28P-2	28	38	16	34 <sup>P=1</sup>	64.5
HS28P-3	28	38	16	34 <sup>P=1</sup>	64.5
HS28P-4	28	38	16	34 <sup>P=1</sup>	64.5
HS28P-4A	28	38	16	34 <sup>P=1</sup>	64.5
HS28P-7	28	38	16	34 <sup>P=1</sup>	64.5
HS28P-8	28	38	16	34 <sup>P=1</sup>	64.5
HS28P-12	28	38	16	34 <sup>P=1</sup>	64.5
HS35PB-2	35	46	19	41 <sup>P=1</sup>	71.5
HS35PB-3	35	46	19	41 <sup>P=1</sup>	71.5
HS35PB-4	35	46	19	41 <sup>P=1</sup>	71.5
HS35PB-16	35	46	19	41 <sup>P=1</sup>	71.5
HS35PB-20	35	46	19	41 <sup>P=1</sup>	71.5

# Receptacle

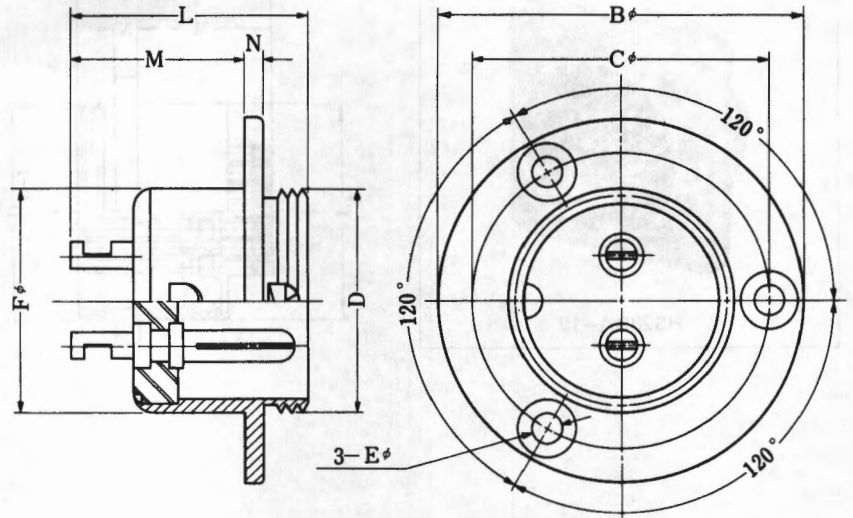
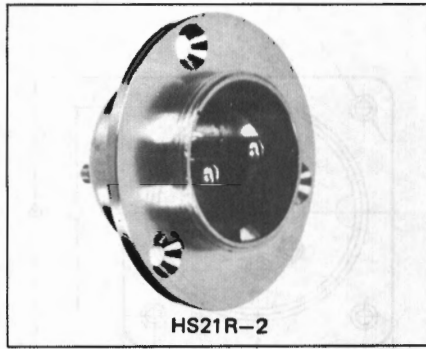

Part No.	Bφ	Cφ	D	Eφ	Fφ	L	M	N	mm
HS12R-2	23	19	15.5 <sup>P=1</sup>	2.1	14	22.5	16	1.5	
HS14R-2	32	25.5	19 <sup>P=1</sup>	3.2	16.5	23	16	2	
HS16R-2	32	25.5	19 <sup>P=1</sup>	3.2	19	23	16	2	
HS16R-3	32	25.5	19 <sup>P=1</sup>	3.2	19	23	16	2	
HS16R-4	32	25.5	19 <sup>P=1</sup>	3.2	19	23	16	2	
HS16R-5	32	25.5	19 <sup>P=1</sup>	3.2	19	23	16	2	
HS21R-2	41	33	25 <sup>P=1</sup>	3.2	25	26	19	2	
HS21R-3	41	33	25 <sup>P=1</sup>	3.2	25	26	19	2	
HS21R-4	41	33	25 <sup>P=1</sup>	3.2	25	26	19	2	
HS21R-5	41	33	25 <sup>P=1</sup>	3.2	25	26	19	2	
HS21R-6	41	33	25 <sup>P=1</sup>	3.2	25	26	19	2	
HS21R-7	41	33	25 <sup>P=1</sup>	3.2	25	26	19	2	
HS21R-8	41	33	25 <sup>P=1</sup>	3.2	25	26	19	2	
HS21R-10	41	33	25 <sup>P=1</sup>	3.2	25	24	17	2	
HS28R-2	46	37	29 <sup>P=1</sup>	3.2	29	26	19	2	
HS28R-3	46	37	29 <sup>P=1</sup>	3.2	29	26	19	2	
HS28R-4	46	37	29 <sup>P=1</sup>	3.2	29	26	19	2	
HS28R-5	46	37	29 <sup>P=1</sup>	3.2	29	26	19	2	
HS28R-5A	46	37	29 <sup>P=1</sup>	3.2	29	26	19	2	
HS28R-6	46	37	29 <sup>P=1</sup>	3.2	29	26	19	2	
HS28R-7	36	37	29 <sup>P=1</sup>	3.2	29	26	19	2	
HS28R-8	46	37	29 <sup>P=1</sup>	3.2	29	26	19	2	
HS28R-10	46	37	29 <sup>P=1</sup>	3.2	29	26	19	2	
HS28R-2	51	43	34 <sup>P=1</sup>	3.2	32	35.5	28	2	
HS28R-3	51	43	34 <sup>P=1</sup>	3.2	32	36	28.5	2	
HS28R-4	51	43	34 <sup>P=1</sup>	3.2	32	26.5	19	2	
HS28R-4A	51	43	44 <sup>P=1</sup>	3.2	32	36	28.5	2	
HS28R-7	51	43	34 <sup>P=1</sup>	3.2	32	26.5	19	2	
HS28R-8	51	43	34 <sup>P=1</sup>	3.2	32	26.5	19	2	
HS28R-12	51	43	34 <sup>P=1</sup>	3.2	32	26.5	19	2	
HS35RC-2	58	50	41 <sup>P=1</sup>	3.2	40	38	28.5	2.5	
HS35RC-3	58	50	41 <sup>P=1</sup>	3.2	40	38	28.5	2.5	
HS35RC-4	58	50	41 <sup>P=1</sup>	3.2	40	36.5	27	2.5	

Note: 1.6φ flat head screw is recommended for mounting.

## Receptacle

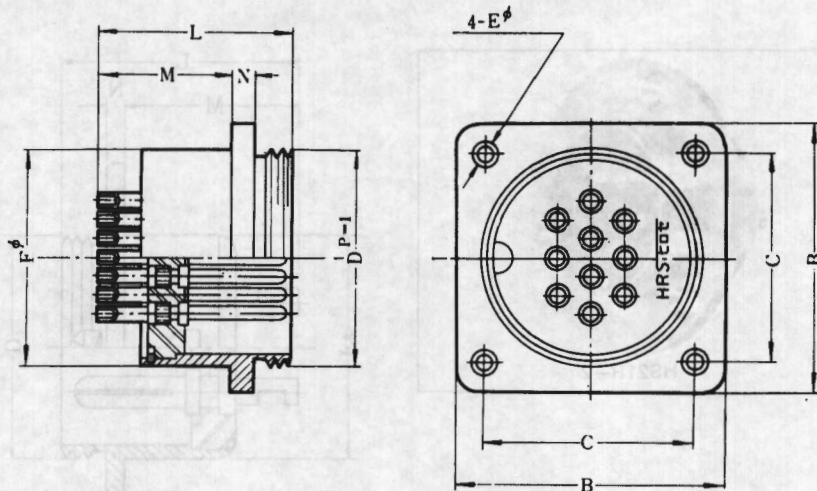

Part No.	B	C	D	Eφ	Fφ	L	M	N	mm
HS28RA-8	38	30	34 <sup>P=1</sup>	3.2	32	26.5	19	2	
HS28RA-12	38	30	34 <sup>P=1</sup>	3.2	32	26.5	19	2	
HS35RA-16	43	35	41 <sup>P=1</sup>	3.2	40	31	21.5	2.5	
HS35RA-20	43	35	41 <sup>P=1</sup>	3.2	40	31	21.5	2.5	

## Jack

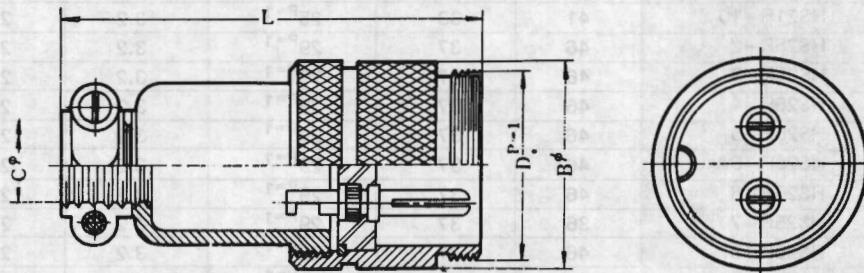

Part No.	Bφ	Cφ	D	L	mm
HS12J-2	18	7	15.5 <sup>P=1</sup>	44.5	
HS16J-2	21.5	8.5	19 <sup>P=1</sup>	50	
HS16J-3	21.5	8.5	19 <sup>P=1</sup>	50	
HS16J-4	21.5	8.5	19 <sup>P=1</sup>	50	
HS16J-5	21.5	8.5	19 <sup>P=1</sup>	50	
HS21J-2	28	10	25 <sup>P=1</sup>	57	
HS21J-3	28	10	25 <sup>P=1</sup>	57	
HS21J-4	28	10	25 <sup>P=1</sup>	57	
HS21J-5	28	10	25 <sup>P=1</sup>	57	

## Plug (Plastic)

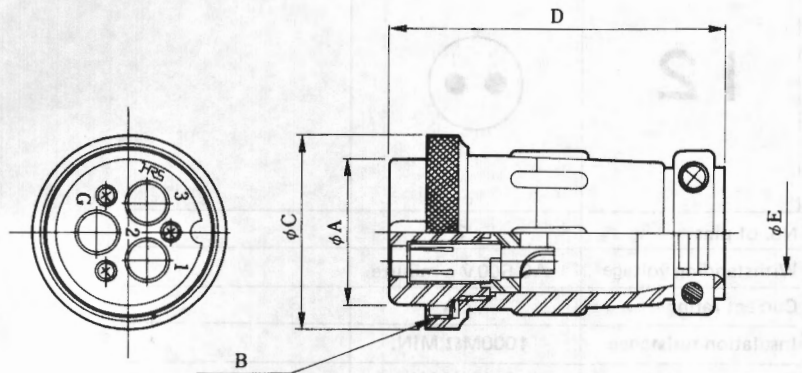

(An example in shape)

HRS No.	Part No.	$\phi A$	B	$\phi C$	D	$\phi E$
101-0541-5	HS21PM-3	21.7	M25 x 1	28	54	10
101-0540-2	HS2BPD-3B	28.6	M34 x 1	38	66	16

Remarks: Class A electric products in compliance with the Electric Products Control Regulations

## Cap for Receptacle

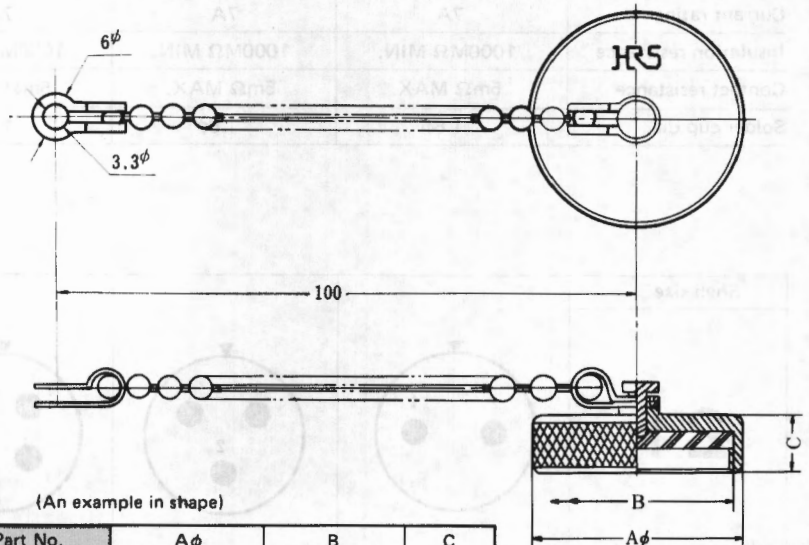





(An example in shape)

HRS No.	Part No.	A $\phi$	B	C
101-0011-1	HS12RC	18	15.5 <sup>P=1</sup>	7
101-0027-1	HS14RC	21.5	19 <sup>P=1</sup>	7
101-0109-4	HS21RC	28	25 <sup>P=1</sup>	7
101-0148-6	HS25RC	32	29 <sup>P=1</sup>	7
101-0174-6	HS28RC	38	34 <sup>P=1</sup>	7
101-0207-3	HS35RC	46	41 <sup>P=1</sup>	9

# Contact Arrangement

Shell size		
<b>12</b>		
	No. of pins	2
	Withstanding voltage	AC 500V a minute
	Current rating	7 A
	Insulation resistance	1000MΩ MIN.
	Contact resistance	5mΩ MAX.
	Solder cup dia.	1.5φ

Shell size		
<b>14</b>		
	No. of pins	2
	Withstanding voltage	AC1000V a minute
	Current rating	7 A
	Insulation resistance	1000MΩ MIN.
	Contact resistance	5mΩ MAX.
	Solder cup dia.	1.5φ

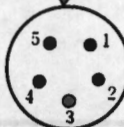
Shell size						
<b>16</b>						
	No. of pins	2	3	4	5	
	Withstanding voltage	AC1000V a minute	AC1000V a minute	AC1000V a minute	AC1000V a minute	
	Current rating	7A	7A	7A	2A	
	Insulation resistance	1000MΩ MIN.	1000MΩ MIN.	1000MΩ MIN.	1000MΩ MIN.	
	Contact resistance	5mΩ MAX.	5mΩ MAX.	5mΩ MAX.	5mΩ MAX.	
	Solder cup dia.	1.8φ	1.8φ	1.8φ	1.5φ	

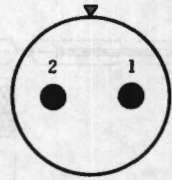
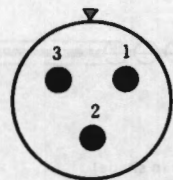
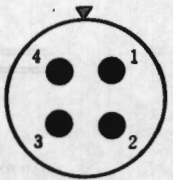
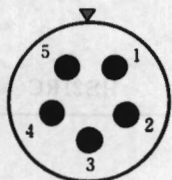
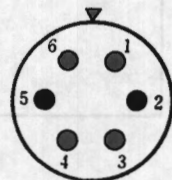
Shell size						
<b>21</b>						
	No. of pins	2	3	4	5	6
	Withstanding voltage	AC1000V a minute	AC1000V a minute	AC1000V a minute	AC1000V a minute	AC1000V a minute
	Current rating	10A	10A	10A	10A	7A
	Insulation resistance	1000MΩ MIN.	1000MΩ MIN.	1000MΩ MIN.	1000MΩ MIN.	1000MΩ MIN.
	Contact resistance	5mΩ MAX.	5mΩ MAX.	5mΩ MAX.	5mΩ MAX.	5mΩ MAX.
	Solder cup dia.	2.0φ	2.0φ	2.0φ	2.0φ	1.5φ





Shell size				
21				
	No. of pins	7	8	10
Withstanding voltage	AC1000V a minute	AC1000V a minute	AC1000V a minute	
Current rating	7A	4A	3A	
Insulation resistance	1000MΩ MIN.	1000MΩ MIN.	1000MΩ MIN.	
Contact resistance	5mΩ MAX.	5mΩ MAX.	5mΩ MAX.	
Solder cup dia.	1.5φ	1.2φ	1.5φ	

Shell size					
25					
	No. of pins	2	3	4	5
Withstanding voltage	AC1000V a minute	AC1000V a minute	AC1000V a minute	AC1000V a minute	AC1000V a minute
Current rating	10A	10A	10A	10A	10A
Insulation resistance	1000MΩ MIN.	1000MΩ MIN.	1000MΩ MIN.	1000MΩ MIN.	1000MΩ MIN.
Contact resistance	5mΩ MAX.	5mΩ MAX.	5mΩ MAX.	5mΩ MAX.	5mΩ MAX.
Solder cup dia.	2.0φ	2.0φ	2.0φ	2.0φ	2.0φ

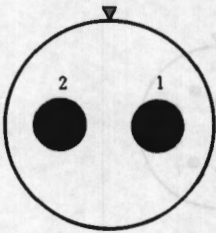
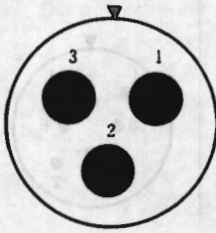
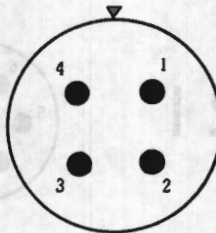
Shell size				
25				
	No. of pins	6	7	8
Withstanding voltage	AC1000V a minute	AC1000V a minute	AC1000V a minute	AC1000V a minute
Current rating	10A	10A	10A	4A
Insulation resistance	1000MΩ MIN.	1000MΩ MIN.	1000MΩ MIN.	1000MΩ MIN.
Contact resistance	5mΩ MAX.	5mΩ MAX.	5mΩ MAX.	5mΩ MAX.
Solder cup dia.	2.0φ	2.0φ	2.0φ	1.2φ

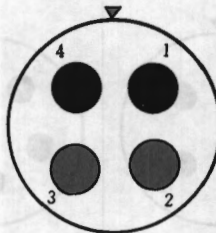
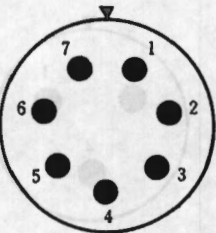
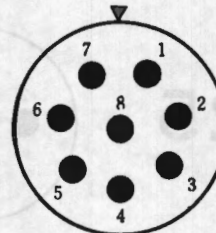
Shell size			
<b>28</b>			
	No. of pins	2	3
Withstanding voltage	AC1000V a minute	AC1000V a minute	AC1000V a minute
Current rating	30A	30A	7A
Insulation resistance	1000MΩ MIN.	1000MΩ MIN.	1000MΩ MIN.
Contact resistance	5mΩ MAX.	5mΩ MAX.	5mΩ MAX.
Solder cup dia.	5.0φ (receptacle: 6φ)	5.0φ (receptacle: 6φ)	1.8φ (receptacle: 1.5φ)

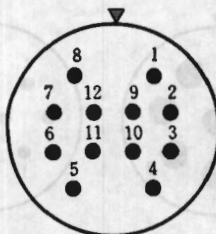
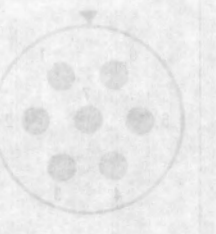
Shell size			
<b>28</b>			
	No. of pins	4A	7
Withstanding voltage	AC1000V a minute	AC1000V a minute	AC1000V a minute
Current rating	20A	10A	10A
Insulation resistance	1000MΩ MIN.	1000MΩ MIN.	1000MΩ MIN.
Contact resistance	5mΩ MAX.	5mΩ MAX.	5mΩ MAX.
Solder cup dia.	4.0φ (receptacle: 5φ)	2.0φ	2.0φ

Shell size			
<b>28</b>			
	No. of pins	12	
Withstanding voltage	AC1000V a minute	AC1000V a minute	AC1000V a minute
Current rating	4A	10A	10A
Insulation resistance	1000MΩ MIN.	1000MΩ MIN.	1000MΩ MIN.
Contact resistance	5mΩ MAX.	5mΩ MAX.	5mΩ MAX.
Solder cup dia.	1.2φ	1.0φ	1.0φ

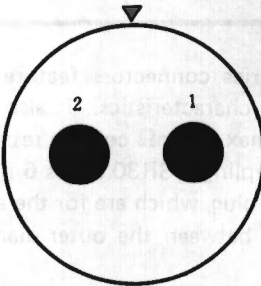
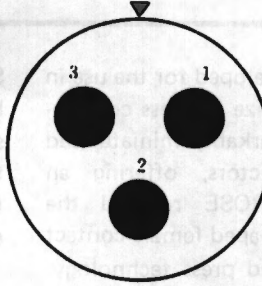
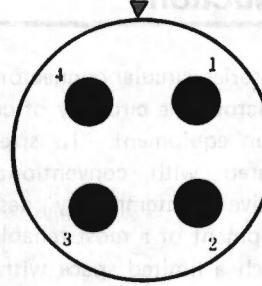
Shell size			
<b>35</b>			
	No. of pins	2	3
Withstanding voltage	AC1000V a minute	AC1000V a minute	AC1000V a minute
Current rating	40A	40A	20A
Insulation resistance	1000MΩ MIN.	1000MΩ MIN.	1000MΩ MIN.
Contact resistance	5mΩ MAX.	5mΩ MAX.	5mΩ MAX.
Solder cup dia.	Crimp contact dia. 4.7φ	Crimp contact dia. 4.7φ	4.0φ (receptacle: 3.0φ)

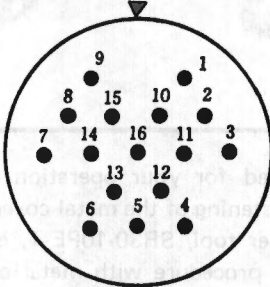
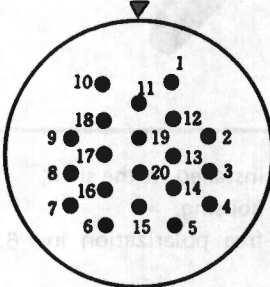
Shell size		
<b>35</b>		
	No. of pins	16
Withstanding voltage	AC1000V a minute	AC1000V a minute
Current rating	4A	4A
Insulation resistance	1000MΩ MIN.	1000MΩ MIN.
Contact resistance	5mΩ MAX.	5mΩ MAX.
Solder cup dia.	1.2φ	1.2φ

**Note:**

1. Contact arrangements are shown at the fitting section of Plug.
2. Insulation resistance is measured at DC 500V.
3. Contact resistance is measured at DC 1A.
4. Withstanding voltage is shown as test voltage, so that the preferable value for daily operation is about one-third of each figure.

# SR 30 SERIES SHELL SIZE 10mm MINIATURE MICROPHONE CONNECTORS

## Introduction

SR30 series circular connectors are developed for the use in the microphone circuitry of compact size wireless communication equipment. Its size is remarkably miniaturized compared with conventional connectors, offering an attractive contemporary design. HIROSE realized the development of a most reliable pipe shaped female contact for such a limited space with advanced press technology.

SR30 series connectors feature reliable performance and low cost characteristics. It also assures long life operation such as max. 15m $\Omega$  contact resistance at DC 1A after 1000 time coupling. SR30 series 6 pin type connector has two types of plug, which are for the application of different size of cable between the outer diameter of 4.2 and 6.2 m/m.

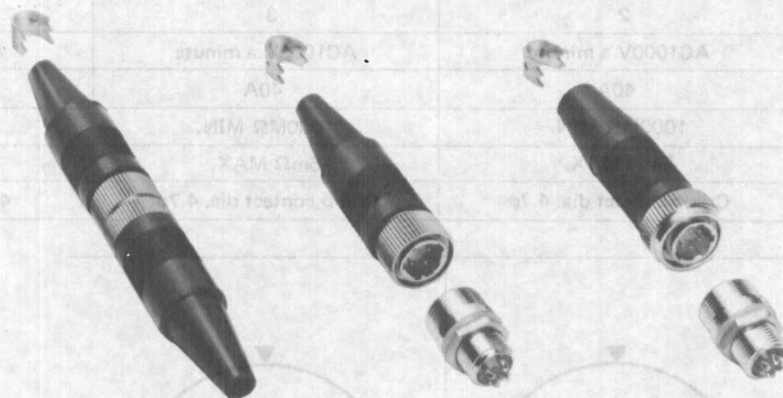

## Features

1. Both 4 and 6-pin multi-contact are installed in the shell size of 12 m/m miniature connector housing.
2. Five key mechanism assures error-free polarization in coupling.
3. Unique cable clamp mechanism by metal clammer is equipped inside connector housing so as to maintain a good looking streamlined appearance.
4. The use of glass-filled polyacetal for molding material helps to offer competitive products.
5. Unique assembling tools, SR30-10P-T03 and -T04, are prepared for your operation of soldering termination and fastening of the metal cover.
6. Another tool, SR30-10PE-T, is also available for cable clamp procedure with metal clammer, SR30-P. But this tool can not be used for SR30-10PM-6P due to cable size difference.
7. Standard applicable cable size is the outer diameter 4.2 – 4.8 m/m. For thicker cable 5.5 – 6.2 m/m, SR30-10PM-6P, 6 pin type only, is available.
8. Jack is available in three types for cable extension program.

## Material and Finish

Male pin:	Brass + gold plated or silver plated
Female pin:	Copper alloy + gold plated or silver plated
Shell:	Brass and Zinc alloy + chromium plated and nickel plated
Metal cover:	Brass, nickel plated
Molding:	Glass-filled polyacetal, white
Hood:	Rubber, black
Metal clammer:	Brass

## Electrical & Environmental

Rated voltage:	AC100V, DC140V
Current rating:	1A
Insulation resistance:	200M $\Omega$ MIN. at DC100V
Contact resistance:	10m $\Omega$ MAX. at DC1A
Withstand voltage:	AC300V MIN. for a minute
Humidity:	20M $\Omega$ MIN. at 40°C, 90%, 96 hour
Vibration:	10–55 cycle/sec. at 1.5m/m amplitude
Temperature cycling:	-30 to +85°C
Durability:	15m $\Omega$ MAX. at DC1A after 1000 time coupling
Salt spray:	48 hour MIN. in 5% salt spray
Insertion force:	3 kgs MAX. at a connector unit

# Plug

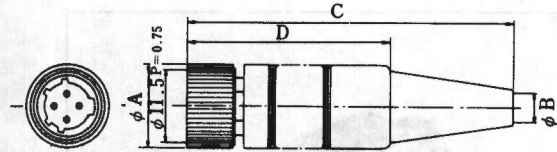

- Note 1. Please order SR30-P for SR30-10PE-6P, SR30-10PX-6P.
- 2. Solder cup dia, of male pin is  $\phi 0.8$ .
- 3. SR30-P1 is used with SR30-10PM-6P.



No. of pin	Part No.	$\phi A$	$\phi B$	C	D	Remarks
4	SR30-10PE-4P	13	4.3	51.5	32	
6	SR30-10PE-6P	13	4.3	51.5	32	Note 1
6	SR30-10PG-6P	13	5.2	49.0	31	
6	SR30-10PX-6P	13	5.7	49.0	-	Note 1
6	SR30-10PB-6P	15	4.3	51.5	32	
6	SR30-10PF-6P	15	5.5	55.0	-	
7	SR30-10PF-7P	15	5.5	55.0	-	Silver plated
4	SR30-10PM-4P	15	5.7	49.0	-	
6	SR30-10PM-6P	15	5.7	49.0	-	Note 3
4	SR30-10PQ-4P	15	4.3	57.5	38	Screw attached
6	SR30-10PQ-6P	15	4.3	57.5	38	Screw attached

# Cable Clamper

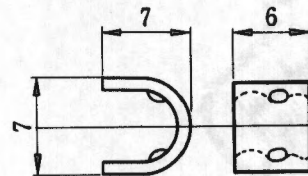
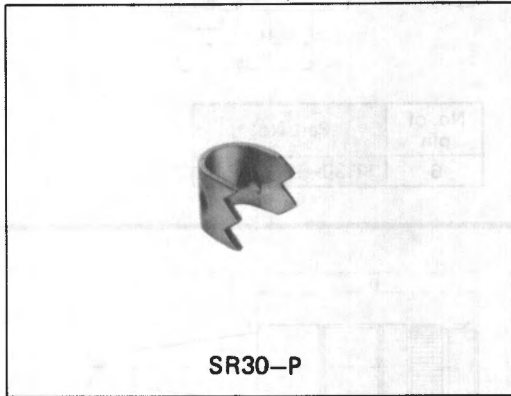

SR30-P

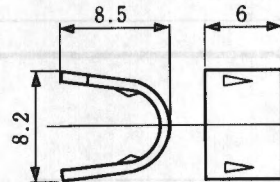

SR30-P1

Part No.	Function
SR30-P	Cable clamper
SR30-P1	

Note: SR30-P is attached with SR30 Plug and Jack except SR30-10PE-6P, SR30-10PX-6P and SR30-10JE-6S.

## Receptacle

### Solder Type

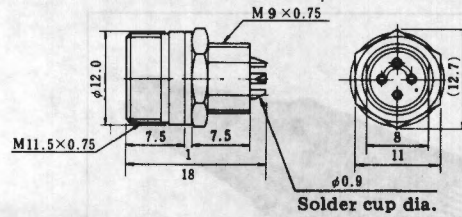
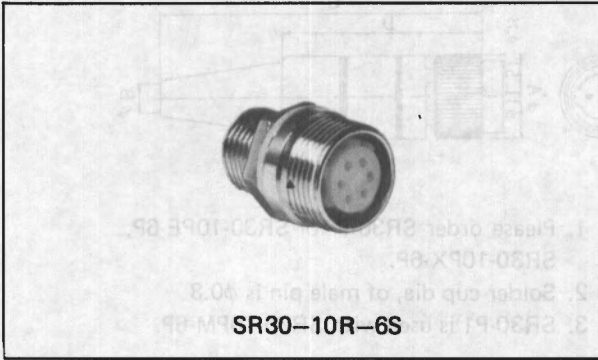

No. of pin	Part No.	Remarks
4	SR30-10R-4S	
6	SR30-10R-6S	
7	SR30-10R-7S	Silver plated

### P.C. Mount Type

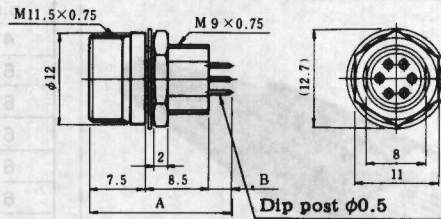
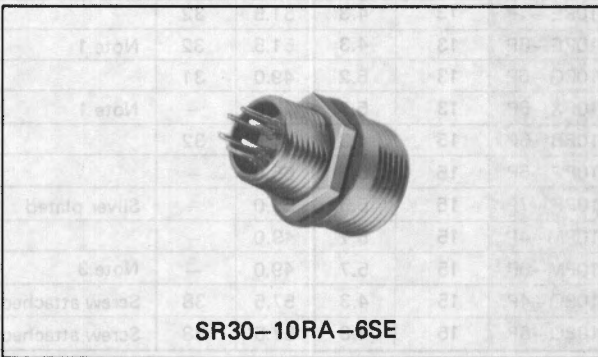

No. of pin	Part No.	A	B	Remarks
6	SR30-10RA-6SE(02)	19	3	
7	SR30-10RA-7SE	19	3	Silver plated
6	SR30-10RA-6SF(01)	24	8	Dip post $\phi 0.5$

## Receptacle (Jam Nut to be fastened from front panel)

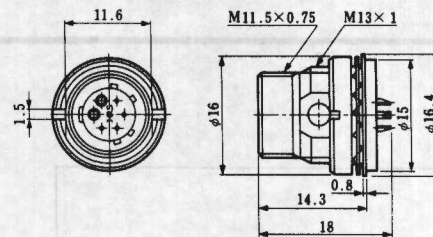
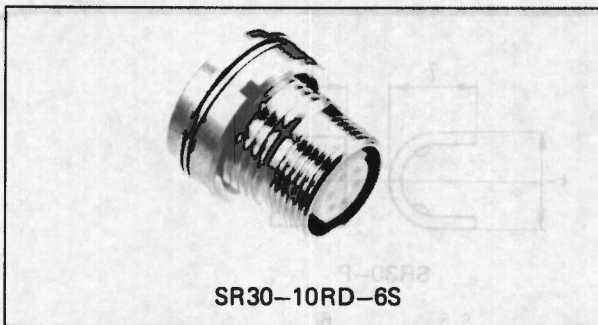

No. of pin	Part No.
6	SR30-10RD-6S

## Jack

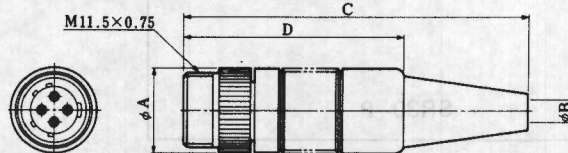

- Note 1. Please order SR30-P for SR30-10JE-6S.  
 Note 2. Solder cup dia. of female pin is  $\phi 0.9$   
 Note 3. SR30-P1 is used with SR30-10JM-6S.

No. of pin	Part No.	A	B	C	D	Remarks
4	SR30-10JE-4S	13	4.3	53.5	34	
6	SR30-10JE-6S	13	4.3	53.5	34	Note 1
6	SR30-10JM-6S	13	5.7	51	—	Note 3
7	SR30-10JF-7S	13	5.5	57	—	Silver plated

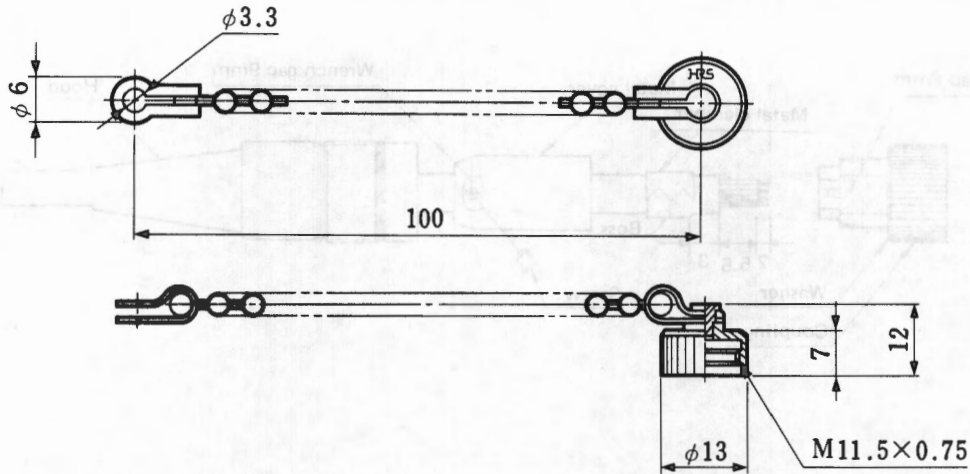

Part No.  
SR30-10RC1

PCB Layout

6 Pin

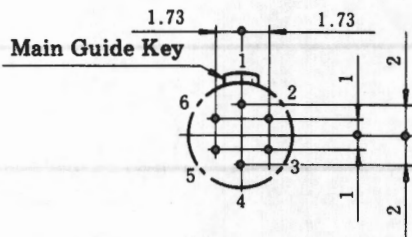

7 Pin

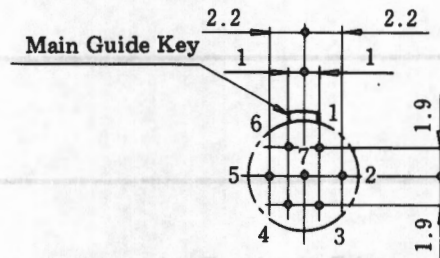

Panel Cutout

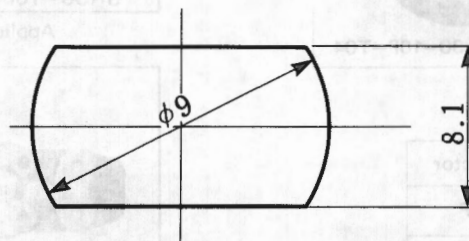

# Assembling Procedure

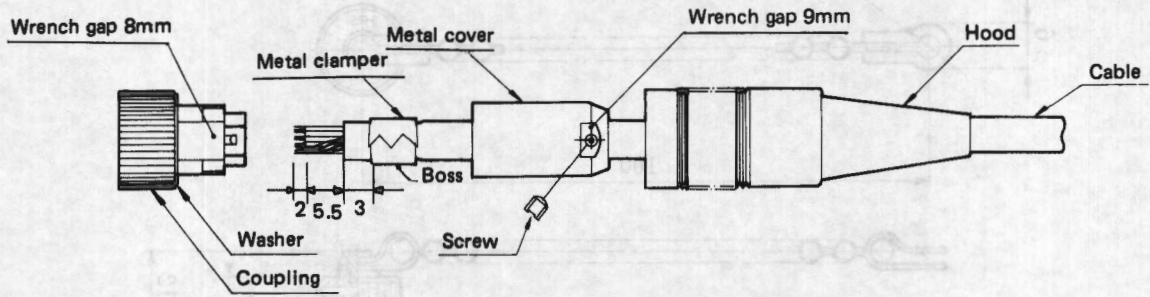

1. Use a cable of 4.2 – 4.8 m/m, for SR30-10PE-4P and SR30-10PE-6P, or 5.5 – 6.2 m/m, for SR30-10PM-6P, in the outer diameter and 0.3 m/m<sup>2</sup> in nominal conductor cross-sectional area.
2. Pass the cable through a hood and a metal cover. Cut off the end of the cable with dimensions as shown.
3. Insert an assembling tool into the block and terminate the cable by soldering.
4. Stake a metal clammer, SR30-P, to the cable several times by means of a crimping tool, SR30-10PE-T, in such a way that the outer diameter becomes about 5.2 m/m.
5. And then, fasten the metal cover into the thread section of plug shell by means of a single-acting torque wrench.
6. Thrust a screw into one of two bosses of the metal clammer in such a way that the tip of screw sinks.
7. Put a hood on the metal cover.

## Tools

### Soldering and Fastening Tool

### Clamping Tool

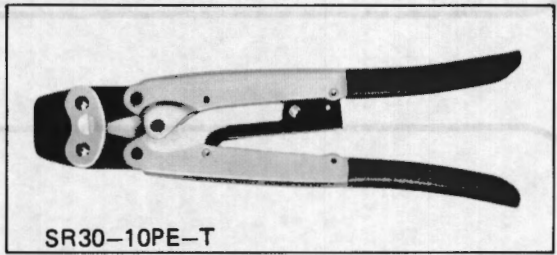
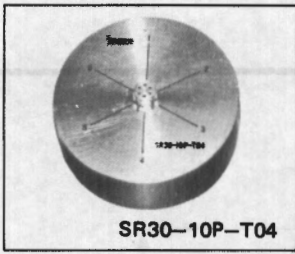
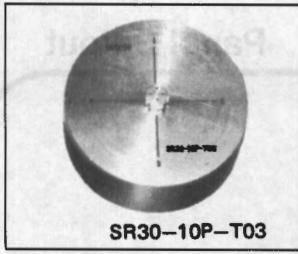

Applicable Cable dia. φ4.2 ~ φ4.8

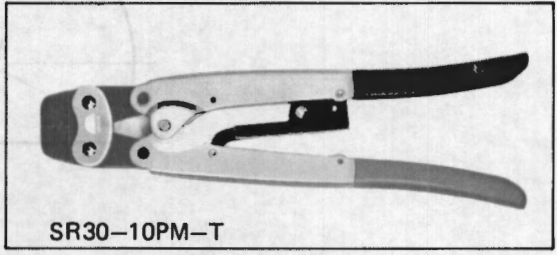

Applicable Cable dia. φ6

Part No.	Applicable connector
SR30-10P-T03	SR30-10PE-4P
SR30-10P-T04	SR30-10PE-6P SR30-10PM-6P



**HRS** HIROSE  
ELECTRIC  
CO.,LTD.

# CIRCULAR CONNECTORS

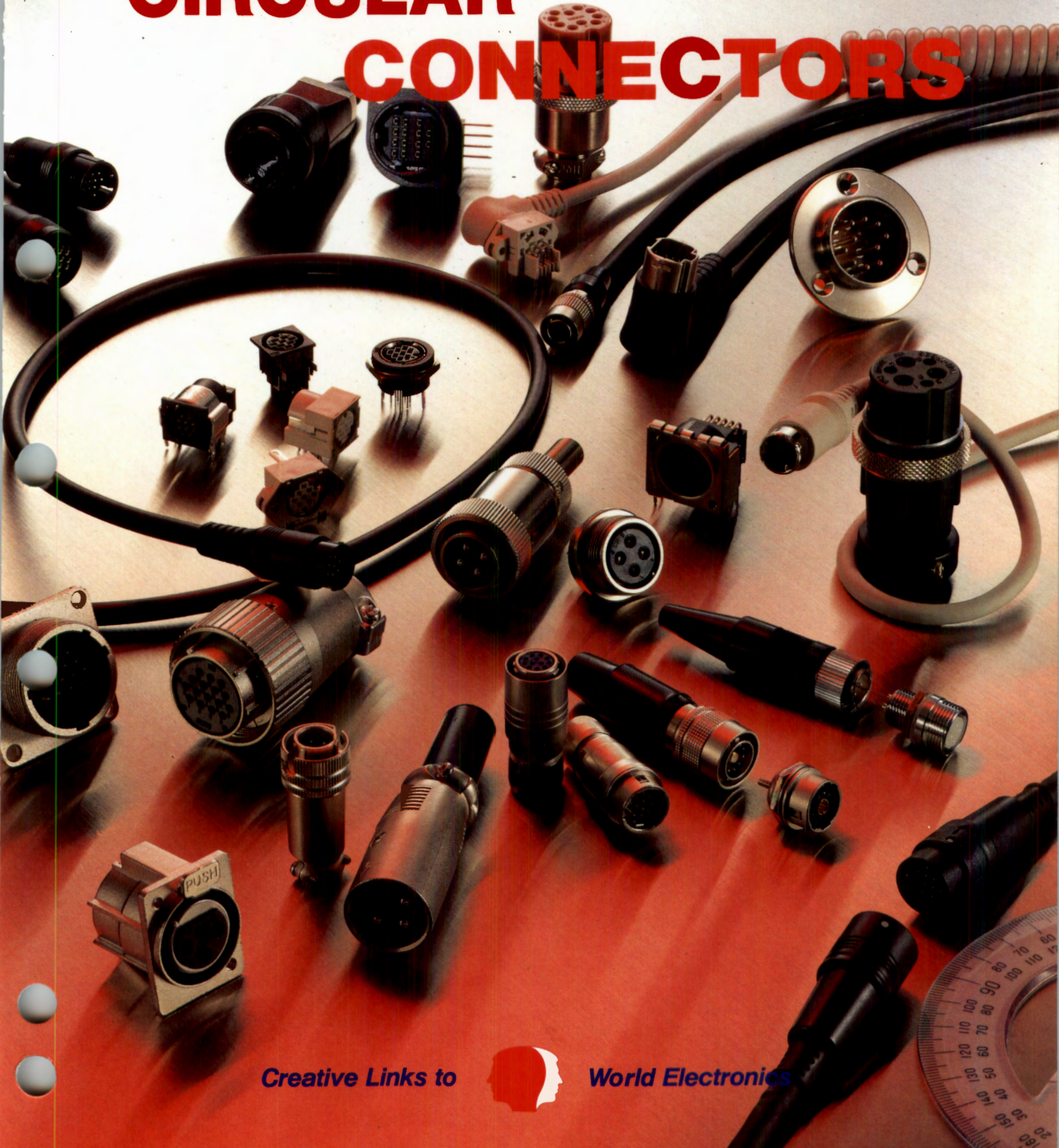

Creative Links to



World Electronics