

Multi-contact Compact Circular Connectors

RM Series



■ Features

1. Wide variations

The RM Series provides a wide selection of plug and receptacle types to satisfy various kinds of application requirements.

Available position counts : 2, 3, 4, 5, 6, 7, 8, 10, 12, 15, and 20.

Available lock mechanisms : threaded coupling type, bayonet sleeve type, and quick detachable type.

■ Product Specifications

Ratings	Rated current	[RM15] 10A (2 and 4 contacts) 5A (8, 10, and 12 contacts) [RM12, 21] 5A	Operating temperature range	-25 to +85°C
	Rated voltage	[RM12] AC 600V, DC 840V (2 contacts) AC 500V, DC 700V (3 and 4 contacts) AC 350V, DC 490V (5, 6 and 7 contacts) [RM15] AC 600V, DC 840V (2 contacts) AC 500V, DC 700V (4 and 8 contacts) AC 350V, DC 490V (10 and 12 contacts) [RM21] AC 500V, DC 700V (15 contacts) AC 350V, DC 490V (20 contacts)	Storage temperature range	-10 to +60°C

Items	Specifications	Conditions
1. Contact resistance	[RM12, 21] 4mΩ max. [RM15] 4mΩ max. (8, 10, and 12 contacts) [RM15] 2mΩ max. (2 and 4 contacts)	Measured at DC 1A
2. Insulation resistance	1,000MΩ min.	Measured at DC 500V
3. Withstanding voltage	No flashover or dielectric breakdown.	[RM12] AC 1,800V for 1 minute (2 contacts) AC 1,500V for 1 minute (3 and 4 contacts) AC 1,000V for 1 minute (5, 6 and 7 contacts) [RM15] AC 1,800V for 1 minute (2 contacts) AC 1,500V for 1 minute (4 and 8 contacts) AC 1,000V for 1 minute (10 and 12 contacts) [RM21] AC 1,500V for 1 minute (15 contacts) AC 1,000V for 1 minute (20 contacts)
4. Vibration resistance	No electrical discontinuity for 10μs. or greater	10 to 55Hz/cycle, full amplitude : 0.75mm, 3 axis directions, 2 hours each
5. Shock resistance	No electrical discontinuity for 10μs. or greater	Acceleration : 490m/s ² , duration : 11ms 3 axis directions, 3 times each
6. Mating cycles	Contact resistance : 8mΩ max.	2,000 times
7. Temperature cycle	Insulation resistance : 100MΩ min.	-55°C : 30 minutes → Normal temperature : 10 to 15 minutes → 85°C : 30 minutes → Normal temperature : 10 to 15 minutes, left for 5 cycles
8. Moisture resistance	Insulation resistance : 100MΩ min. (when dry)	Temperature : 40°C, relative humidity : 90 to 95%, left for 96 hours

■ Product Number Structure

Refer to the chart below when determining the product specifications from the product number.
Please select from the product numbers listed in this catalog when placing orders.

● Plug

RM 15 T P A - 2 S (**)

① ② ③ ④ ⑤ ⑥ ⑦ ⑧

① Model name : RM Series (Round Miniature Series)
② Shell size : The shell size refers to the outer shell diameter of the mating interface of the plug.
③ Lock mechanism T : Threaded coupling type B : Bayonet sleeve type Q : Quick detachable type
④ Connector type (1) P : Plug J : Jack P-C : Plug cap R-F : Square flange for receptacle (2) R : Receptacle R-C : Receptacle cap R-B : Cord bushing
⑤ Form variation class : Indicates a variation or change within the series.
⑥ Number of contacts
⑦ Contact form P : Male contact S : Female contact
⑧ Other specifications : A two-digit number is added to indicate other specifications.

■ Materials / Finish

Items	Material	Finish	Remarks
Plated shell	Brass, zinc alloy Aluminum alloy	Nickel plating Chromium plating	_____
Insulator	Diallyl phthalate resin Polycarbonate resin, PPS	_____	UL94V-0 (Black)
Contact	Brass or copper alloy	Silver plating	_____

Please note that materials will differ depending on the actual part number.

■ RM12B connectors (bayonet sleeve type)

● Plug

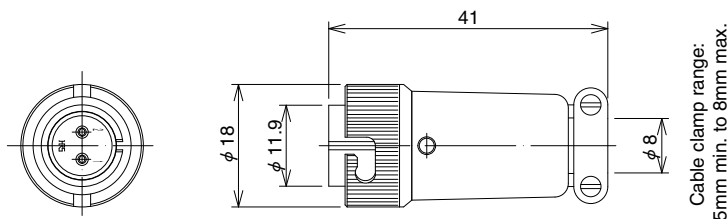

(Representative example.)

Part No.	HRS No.	No. of contacts
RM12BPE-2S(71)	109-0423-0 71	2
RM12BPE-3S(71)	109-0424-2 71	3
RM12BPE-4S(71)	109-0425-5 71	4
RM12BPE-5S(71)	109-0426-8 71	5
RM12BPE-6S(81)	109-0427-0 81	6
RM12BPE-7S(71)	109-0428-3 71	7

Part No.	HRS No.	No. of contacts
RM12BPE-2PH(71)	109-0417-7 71	2
RM12BPE-3PH(71)	109-0418-0 71	3
RM12BPE-4PH(71)	109-0419-2 71	4
RM12BPE-5PH(71)	109-0420-1 71	5
RM12BPE-6PH(71)	109-0421-4 71	6
RM12BPE-7PH(71)	109-0422-7 71	7

● Receptacle (Jam nut to be fastened)

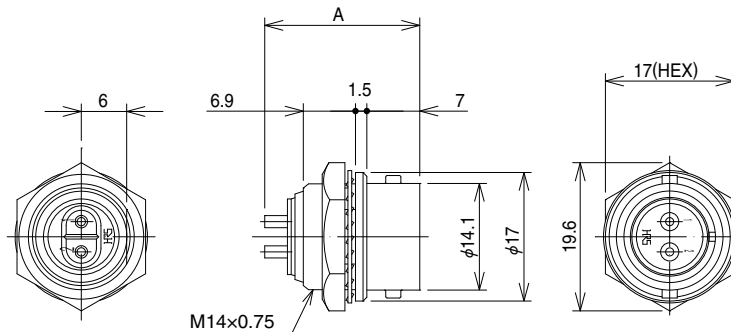

(Representative example.)

Part No.	HRS No.	No. of contacts	A
RM12BRD-2PH(71)	109-0823-8 71	2	20.5
RM12BRD-3PH(71)	109-0824-0 71	3	
RM12BRD-4PH(71)	109-0825-3 71	4	
RM12BRD-5PH(71)	109-0826-6 71	5	
RM12BRD-6PH(71)	109-0827-9 71	6	
RM12BRD-7PH(71)	109-0828-1 71	7	

Part No.	HRS No.	No. of contacts	A
RM12BRD-2S(71)	109-0609-8 71	2	21.6
RM12BRD-3S(71)	109-0610-7 71	3	
RM12BRD-4S(71)	109-0611-0 71	4	
RM12BRD-5S(71)	109-0612-2 71	5	
RM12BRD-6S(81)	109-0613-5 81	6	
RM12BRD-7S(71)	109-0619-1 71	7	

Remarks : See page 12 for details on recommended panel cut-out.

● Receptacle (Integral, square flange)

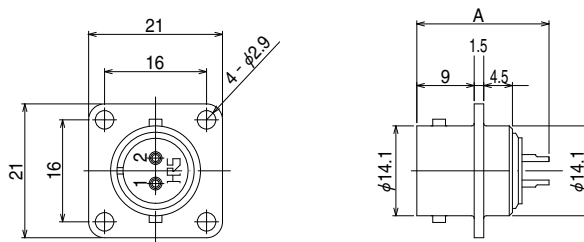

(Representative example.)

Part No.	HRS No.	No. of contacts	A
RM12BRB-2S	109-0577-3	2	21.6
RM12BRB-3S	109-0578-6	3	
RM12BRB-4S	109-0579-9	4	
RM12BRB-5S	109-0580-8	5	
RM12BRB-6S(81)	109-0581-0 81	6	
RM12BRB-7S	109-0615-0	7	

Part No.	HRS No.	No. of contacts	A
RM12BRB-2PH	109-0817-5	2	20.5
RM12BRB-3PH	109-0818-8	3	
RM12BRB-4PH	109-0819-0	4	
RM12BRB-5PH	109-0820-0	5	
RM12BRB-6PH	109-0821-2	6	
RM12BRB-7PH	109-0822-5	7	

Remarks : 1. See page 12 for details on recommended panel cut-out.
 2. Please note that the RM12BRB differs in mounting dimensions from the RM12BR-F.

● Jack

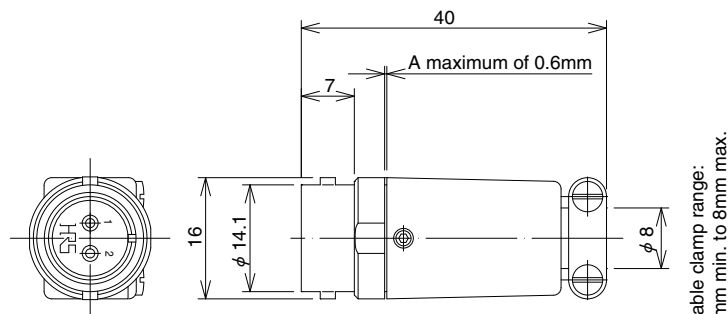

Cable clamp range:
5mm min. to 8mm max.

(Representative example.)

Part No.	HRS No.	No. of contacts
RM12BJB-2S(07)	109-0638-6 07	2
RM12BJB-3S(07)	109-0639-9 07	3
RM12BJB-4S(07)	109-0640-8 07	4
RM12BJB-5S(07)	109-0641-0 07	5
RM12BJB-6S(81)	109-0642-3 81	6
RM12BJB-7S(07)	109-0643-6 07	7

Part No.	HRS No.	No. of contacts
RM12BJB-2PH	109-0829-4	2
RM12BJB-3PH	109-0830-3	3
RM12BJB-4PH	109-0831-6	4
RM12BJB-5PH	109-0832-9	5
RM12BJB-6PH	109-0833-1	6
RM12BJB-7PH	109-0834-4	7

■ RM15Q connectors (quick detachable type)

● Plug

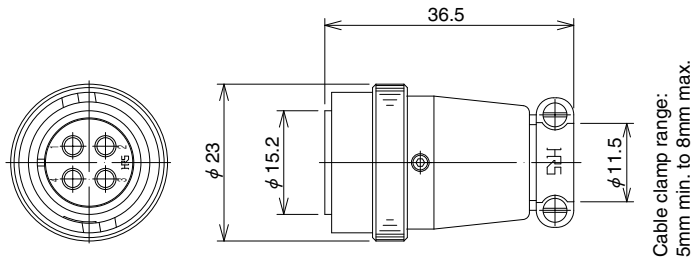

(Representative example.)

Part No.	HRS No.	No. of contacts
RM15QPS-2SA(71)	109-0839-8 71	2
RM15QPS-4SA(81)	109-0840-7 81	4
RM15QPS-8S(71)	109-0852-6 71	8
RM15QPS-10S(71)	109-0853-9 71	10
RM15QPS-12S(71)	109-0981-9 71	12

Part No.	HRS No.	No. of contacts
RM15QPS-2PA(71)	109-0896-1 71	2
RM15QPS-4PA(71)	109-0897-4 71	4
RM15QPS-8PH(71)	109-0850-0 71	8
RM15QPS-10PH(71)	109-0851-3 71	10
RM15QPS-12PH(71)	109-0980-6 71	12

● Receptacle (Jam nut to be fastened)

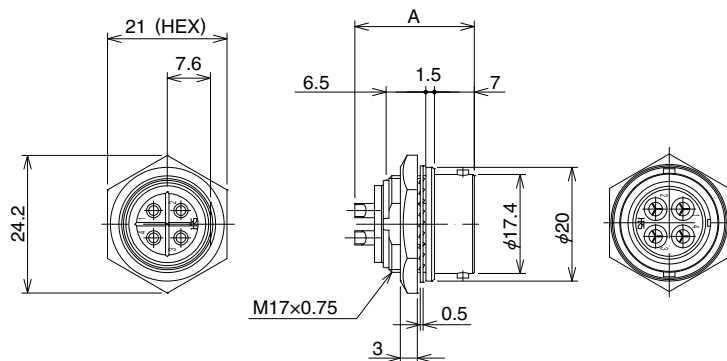

(Representative example.)

Part No.	HRS No.	No. of contacts	A
RM15QRD-2PA(71)	109-0880-1 71	2	21.0
RM15QRD-4PA(71)	109-0881-4 71	4	
RM15QRD-8PH(71)	109-0854-1 71	8	20.6
RM15QRD-10PH(71)	109-0855-4 71	10	
RM15QRD-12PH(71)	109-0982-1 71	12	

Part No.	HRS No.	No. of contacts	A
RM15QRD-2SA(71)	109-0841-0 71	2	21.7
RM15QRD-4SA(81)	109-0842-2 81	4	
RM15QRD-8S(71)	109-0864-5 71	8	21.6
RM15QRD-10S(71)	109-0779-8 71	10	
RM15QRD-12S(71)	109-0983-4 71	12	

Remarks : See page 12 for details on recommended panel cut-out.

■ RM [] T connectors (threaded coupling type)

● Plug

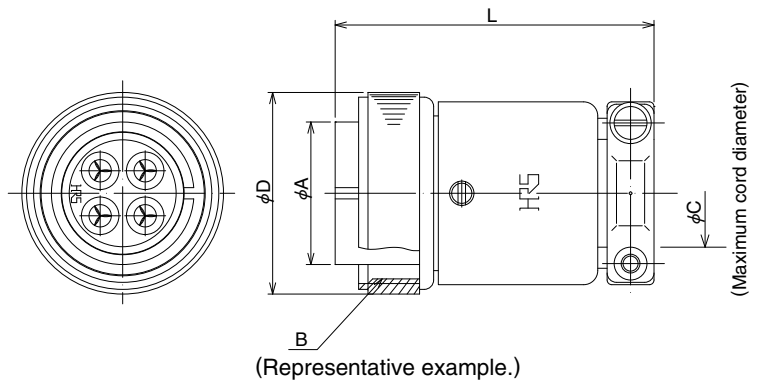

Part No.	HRS No.	No. of contacts	φA	B	φC	φD	L					
RM15TP-2SA(71)	109-0845-0 71	2	15.2	M19×1	11.5	21.5	34					
RM15TP-2PA(71)	109-0898-7 71											
RM15TP-4SA(81)	109-0846-3 81	4										
RM15TP-4PA(71)	109-0899-0 71											
RM15TP-8S(71)	109-0053-2 71	8										
RM15TP-8PH(71)	109-0856-7 71											
RM15TP-10S(71)	109-0055-8 71	10										
RM15TP-10PH(71)	109-0857-0 71											
RM21TP-15S(81)	109-0321-0 81	15						21	TM25×2	15	28	37
RM21TP-15P(71)	109-0323-5 71											
RM21TP-20S(81)	109-0322-2 81	20										
RM21TP-20P(71)	109-0324-8 71											

Remarks : TM25x2 represents 30° trapezoidal thread profile.

● Receptacle (Jam nut to be fastened)

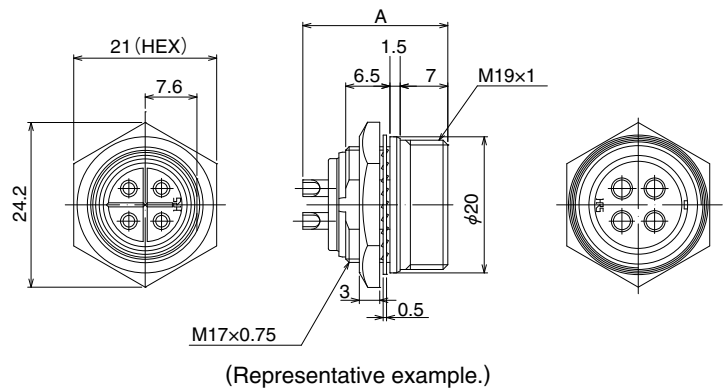

Part No.	HRS No.	No. of contacts	A
RM15TRH-2PA(71)	109-0886-8 71	2	21
RM15TRH-2SA(71)	109-0847-6 71		21.7
RM15TRH-4SA(81)	109-0848-9 81	4	21
RM15TRH-4PA(71)	109-0887-0 71		
RM15TRH-8PH(71)	109-0858-2 71	8	20.6
RM15TRH-8S(71)	109-0868-6 71		21.6
RM15TRH-10PH(71)	109-0859-5 71	10	20.6
RM15TRH-10S(71)	109-0869-9 71		21.6

Remarks : See page 12 for details on recommended panel cut-out.

● Receptacle (Jam nut to be fastened)

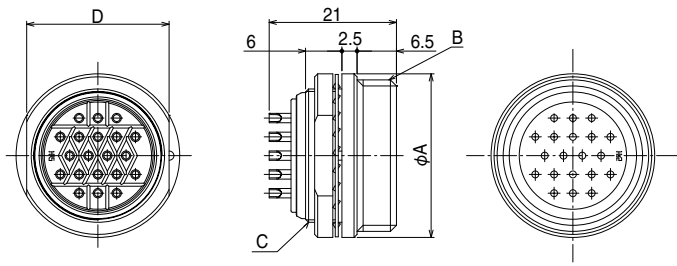

(Representative example.)

Part No.	HRS No.	No. of contacts	ϕA	B	C	D
RM21TR-15S(81)	109-0327-6 81	15	27	TM25x2	M22x0.75	23.5
RM21TR-15P(71)	109-0325-0 71					
RM21TR-20S(81)	109-0328-9 81	20				
RM21TR-20P(71)	109-0326-3 71					

Remarks : 1. TM25x2 represents 30° trapezoidal thread profile.
 2. See page 12 for details on recommended panel cut-out.

■ RM15T (type D) connectors

● Plug (solder type)

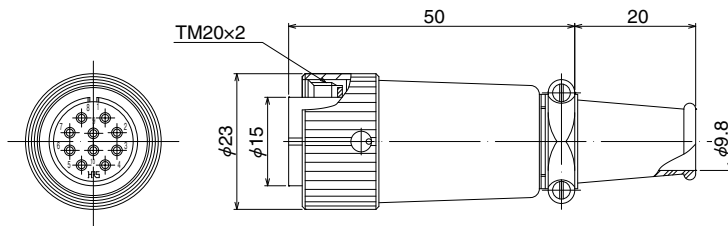

(Representative example.)

Part No.	HRS No.	No. of contacts
RM15TPD-10P(71)	109-0601-6 71	10
RM15TPD-10S(71)	109-0686-9 71	
RM15TPD-12P(71)	109-0660-5 71	12
RM15TPD-12S(71)	109-0661-8 71	

● Jack (solder type)

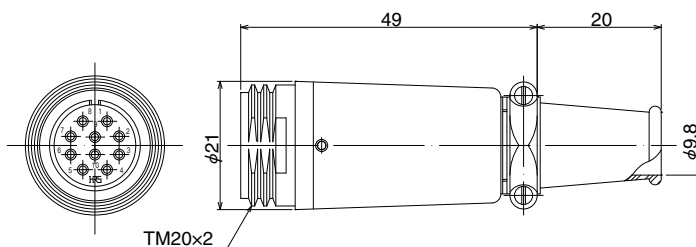

(Representative example.)

Part No.	HRS No.	No. of contacts
RM15TJD-10P(71)	109-0706-4 71	10
RM15TJD-10S(71)	109-0603-1 71	
RM15TJD-12P(71)	109-0715-5 71	12
RM15TJD-12S(71)	109-0665-9 71	

● Receptacle (solder type)

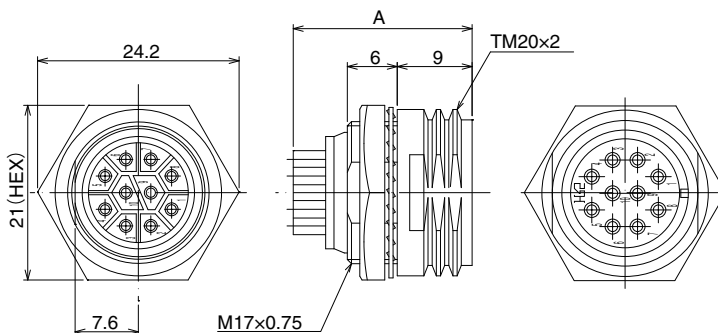

(Representative example.)

Part No.	HRS No.	No. of contacts	A
RM15TRD-10P(71)	109-0687-1 71	10	20.5
RM15TRD-10S(71)	109-0602-9 71		21.3
RM15TRD-12P(71)	109-0662-0 71	12	20.5
RM15TRD-12S(71)	109-0663-3 71		21.3

Remarks : See page 12 for details on recommended panel cut-out.

● Plug (crimp type)

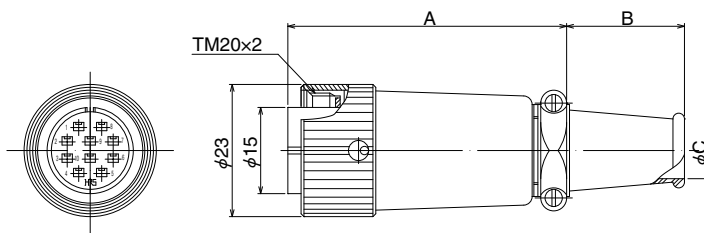

(Representative example.)

Part No.	HRS No.	No. of contacts	A	B	φC
RM15TPD-10PC(71)	109-0677-8 71	10	50	20	9.8
RM15TPN-10PC(71)	109-0712-7 71		40	15	8

● Receptacle (crimp type)

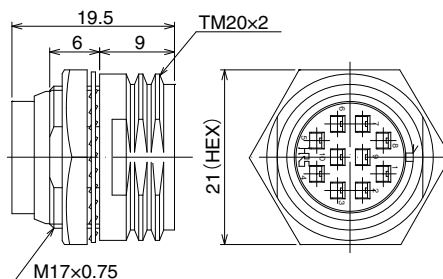

(Representative example.)

Part No.	HRS No.	No. of contacts
RM15TRD-10SC(71)	109-0676-5 71	10

Remarks : See page 12 for details on recommended panel cut-out.

● Receptacle (dip type)

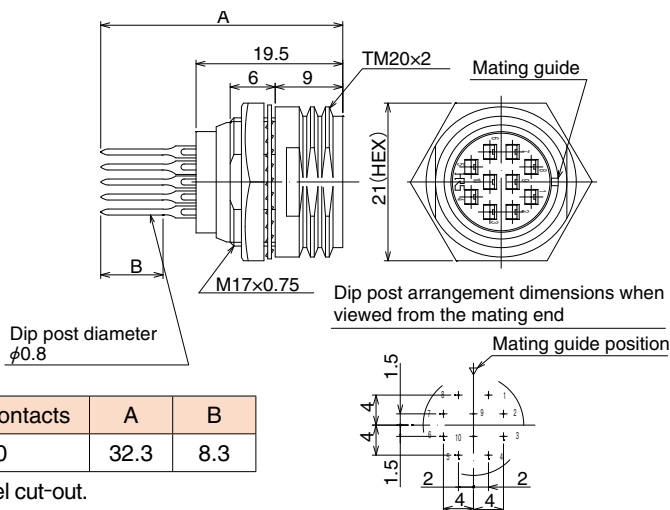

Part No.	HRS No.	No. of contacts	A	B
RM15TRD-10SB(71)	109-0710-1 71	10	32.3	8.3

Remarks : See page 12 for details on recommended panel cut-out.

(Representative example.)

RM Series accessories

Cap

● Plug cap

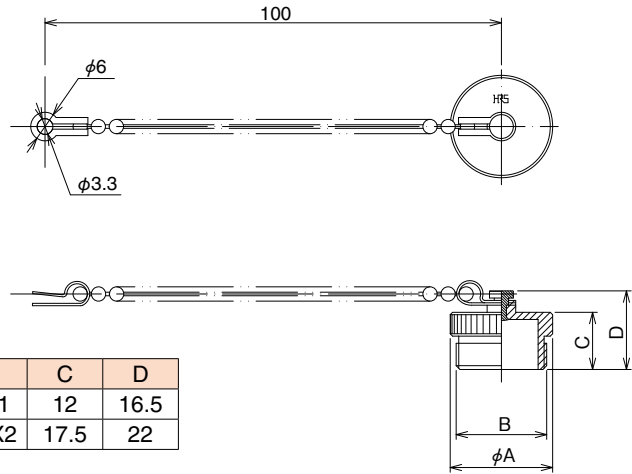

Part No.	HRS No.	φA	B	C	D
RM15TP-C(71)	109-0079-6 71	21.5	M19X1	12	16.5
RM21TP-C(71)	109-0353-6 71	28	TM25X2	17.5	22

● Receptacle cap

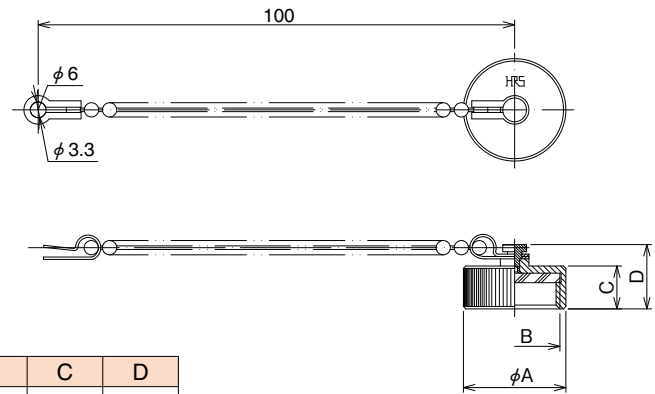

Part No.	HRS No.	φA	B	C	D
RM15TR-C(31)	109-0080-5 31	21.5	M19X1	9	13.5
RM21TR-C(31)	109-0354-9 31	28	TM25X2	8	12.5

● Square flange

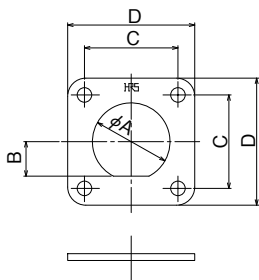

Part No.	HRS No.	φA	B	C	D
RM12BR-F(71)	109-0154-0 71	14.1	6	18	26
RM15TR-F(71)	109-0319-8 71	17.1	7.6	20.6	28

● Cord bushing

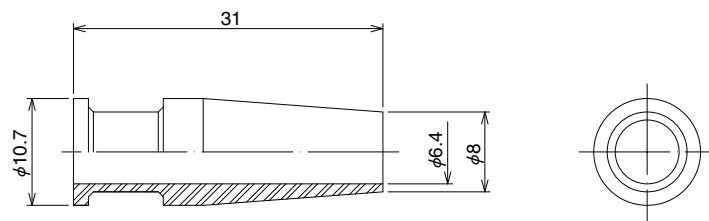

Part No.	HRS No.	Remarks
RM12BPG-B(71)	109-0776-0 71	—

◆ Contact

● Male contact

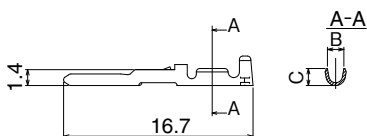

Type	Part No.	HRS No.	B	C	Applicable wire size
Loose piece contacts	RM-PC-112	109-0668-7	1.6	2.0	20 to 24 AWG
	RM-PC-122	109-0672-4	1.45	1.5	24 to 28 AWG
Reel contacts	RM-PC-212	109-0670-9	1.6	2.0	20 to 24 AWG
	RM-PC-222	109-0674-0	1.45	1.5	24 to 28 AWG

● Female contact

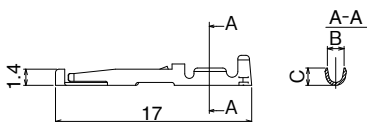

Type	Part No.	HRS No.	B	C	Applicable wire size
Loose piece contacts	RM-SC-112	109-0669-0	1.6	2.0	20 to 24 AWG
	RM-SC-122	109-0673-7	1.45	1.5	24 to 28 AWG
Reel contacts	RM-SC-212	109-0671-1	1.6	2.0	20 to 24 AWG
	RM-SC-222	109-0675-2	1.45	1.5	24 to 28 AWG

Note : Loose piece contacts are available in 100 pcs/pack. Reel contacts are available in 8,000 pcs/reel.

◆ Applicable tools

Type	Items	Part No.	HRS No.	Applicable contact	Applicable wire size
Manual	Manual crimping tool	HT802/RM-11	150-0401-6	RM-PC-112 RM-SC-112	20 to 24 AWG
		HT802/RM-12	150-0402-9	RM-PC-122 RM-SC-122	24 to 28 AWG
Automatic	Automatic crimping press	CM-105C	901-0001-0	_____	_____
	Applicator	AP-105-RM-1	901-2017-4	RM-PC-212 RM-SC-212	20 to 24 AWG
		AP-105-RM-2	901-2018-7	RM-PC-222 RM-SC-222	24 to 28 AWG
Extraction tool		RM-TP	150-0008-7	_____	_____

◆ Manual crimping tool



◆ Contact extraction tool



◆ Automatic crimping press (Type CM-105C)



◆ How to use the RM15Q connectors (quick detachable type)

1. Insertion



For smooth mating, while holding the plug tube, match the guide of the receptacle with the key-way on the plug and push straight it in as shown in the above figure.

2.Extraction



To unmate, hold the locking sleeve and twist it approximately 30 degrees to the left, then pull it straight off as shown in the above figure.

◆ Receptacle-recommended panel cut-out

● For jam nut type

Recommended panel cut-out for shell sizes 12 and 15

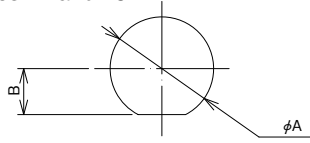

Recommended panel cut-out for shell sizes 21

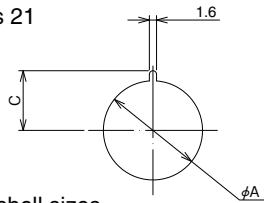

● For square flange type

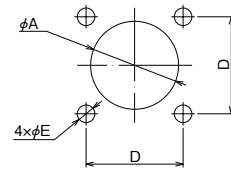

Remarks : Use a 0.5 ~ 2 mm thickness panel for all shell sizes.

Sign	Mounting method Shell size Locking mechanism	Nut tightening			Square flange
		12	15		12
		BRD	QRD	TRH · TRD	TR
φA		14.1	17.1		22.1
B		6.1	7.6		
C					12.65
D					1.6
φE					2.9

Remarks : The dimensional tolerance to be +0.1 / 0.

◆ Contact Position Arrangement and Specifications

Contact arrangement	Shell size : 12					Shell size : 15	
No. of contacts	2	3	4	5	7	2	4
Withstanding voltage	AC 1,800V for one minute	AC 1,500V for one minute			AC 1,000V for one minute	AC 1,800V for one minute	AC 1,500V for one minute
Rated current	5A					10A	
Insulation resistance	1,000MΩ min.					1,000MΩ min.	
Contact resistance	4mΩ max.					2mΩ max.	
Inner diameter of solder pot	φ1.1mm					φ1.7mm	

Contact arrangement	Shell size : 15			Shell size : 21		
No. of contacts	8	10	12	15	20	
Withstanding voltage	AC 1,500V for one minute	AC 1,000V for one minute			AC 1,500V for one minute	AC 1,000V for one minute
Rated current	5A			5A		
Insulation resistance	1,000MΩ min.			1,000MΩ min.		
Contact resistance	4mΩ max.			4mΩ max.		
Inner diameter of solder pot	φ1.1mm			φ1.1mm		

Remarks

1. The above figures show contact arrangements viewed from the mating end of the connectors with female contacts.
2. The "▼" marks shown in the above figures represent the position of the receptacle mating guide.
3. Withstanding voltages are shown as test voltages.

◆ Precautions

1. Be sure the power is off before mating/unmating a connector.
2. Be sure to use a connector with female contacts for the power side of the circuit.
3. Be sure to engage the lock mechanism on the connectors.
4. Regarding plugs and jacks : the forces from cable clamping, cable rotation, and other forces may vary with the cable construction. Please make sure that your cable is suitable for use with these connectors before usage and production.
5. This product series uses silver plated contacts. Silver reacts easily to exposure to sulfur gas so the below conditions may cause tarnishing.
 - Dusty environments
 - Area with a high concentration area of gases such as sulfur dioxide gas, hydrogen sulfide gas, nitrogen dioxide gas and so on.
Example; In close proximity to factory exhaust, automotive emissions, etc.
 - Close to heaters, or in other areas marked by extreme temperature differences or high humidity.
 - Close to rubber products includes rubber adhesives.

The Electrical connection is not affected by tarnishing on a silver surface due to the wiping effect of the contact pins.

Storage

Packing state; Packed in original packing or equivalent container

Temperature -10 to +60°C

Humidity 85% Max

(It is recommended that the product be stored in an area of normal level of temperature and humidity, and free of any temperature fluctuation)

Please use this products within 6 months of delivery.

(After 6 month, please check the solderability before use)

“Storage” means long-term storage of the unused products in sealed packaging, prior to assembly to PCB.



HIROSE ELECTRIC CO.,LTD.

2-6-3,Nakagawa Chuoh,Tsuzuki-Ku,Yokohama-Shi 224-8540,JAPAN

TEL: +81-45-620-3526 Fax: +81-45-591-3726

<http://www.hirose.com>

<http://www.hirose-connectors.com>