

CRAMER ELAPSED TIME INDICATORS

Designed for use wherever elapsed time must be accurately measured and accumulated. Ideal devices for measuring down time, for equipment maintenance or performance evaluation. Figures are .200" high x .100" wide and are legible at a distance of 10 feet with no portion of the preceding digit or following digit to distract the eye. Available in round or square bezel styles. The utility models 635-G and 635-K are similar to models 636-X and 636-Y respectively. They differ only in the type of lens mask and sealing arrangement utilized. The bezels of the 635-G and 635-K are moulded integrally with the housing (not detachable as with other types in the 635 and 636 Series).

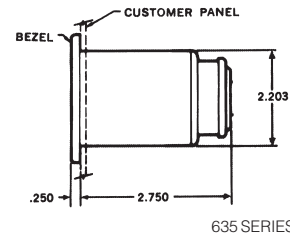
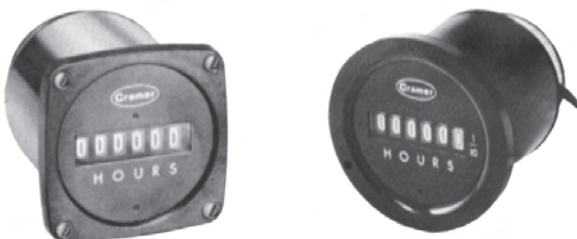

CRAMER 635 SERIES NON-RESETTABLE 6-DIGIT INDICATORS—120 VAC, 60 Hz.

Available in round or square bezel styles, 2.50" or 3.50". Time ranges available are: 99999.9 Minutes; 99999.9 Hours. Over-all length (all Type 635 models): 2.65". Barrel diameter: 2.187". Weight: 12 oz. approx.

Cat. No.	Timing Range	Type No.	Description	Net Price
10055	99999.9 Hrs.	635-E	3.50" Round Bezel	\$106.00
10069	99999.9 Min.	635-G	2.50" Round Utility Model	86.00
10071	99999.9 Hrs.			86.00
10184	99999.9 Min.	635-K	2.50" Square Utility Model	86.00
10186	99999.9 Hrs.			86.00
10061	99999.9 Min.	635-S	3.50" Square Bezel	106.00
10063	99999.9 Hrs.			106.00

*Bezel sizes are nominal and reflect industry case sizes. See drawings for actual dimensions.

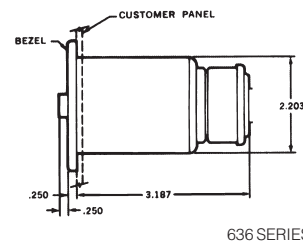

CRAMER 636 SERIES RESETTABLE 5-DIGIT INDICATORS—120 VAC, 60 Hz.

Similar to 635 Series indicators, but feature a unique pushbutton reset. Available in round or square bezel styles, 2.50" or 3.50". Time ranges available are: 9999.9 Seconds; 9999.9 Minutes; 9999.9 Hours. Dimensions are identical to comparable models in the 635 Series.

Cat. No.	Timing Range	Type No.	Description	Net Price
10076	9999.9 Sec.	636-E	3.50" Round Bezel	\$180.00
10078	9999.9 Min.			180.00
10079	9999.9 Hrs.			180.00
10084	9999.9 Sec.	636-S	3.50" Square Bezel	180.00
10086	9999.9 Min.			180.00
10087	9999.9 Hrs.			180.00
10072	9999.9 Sec.	636-X	2.50" Round Bezel	180.00
10074	9999.9 Min.			180.00
10075	9999.9 Hrs.			180.00
10080	9999.9 Sec.	636-Y	2.50" Square Bezel	180.00
10082	9999.9 Min.			180.00
10083	9999.9 Hrs.			180.00

*Bezel sizes are nominal and reflect industry case sizes. See drawings for actual dimensions.

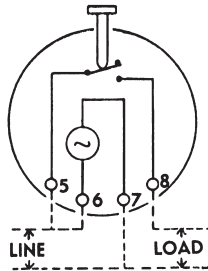

CRAMER 241 SERIES

AUTOMATIC RESET INTERVAL TIMERS—120 VAC, 60 Hz.

Highly accurate, motor-driven interval timers for panel mounting. Features include pushbutton operation, automatic reset and elapsed time indication. Timing cycle is initiated by pushing button built into centre of adjustment knob, instantly transferring contacts. A pointer on the dial face shows timing progression. Contacts drop out at end of the timing cycle, and timer resets within 0.5 Seconds. Contacts are SPDT, rated 15 amperes resistive @ 120 VAC. Nominal operating voltage: 120 VAC, 60 Hz. Dial and pointers are protected by a clear plastic dome. Repeat accuracy for units having a time range of 30 Seconds or longer is 0.25% of full scale; 0.5% of full scale for shorter ranges. Flange diameter: 3³/₄" ; depth behind panel: 3¹/₈". Mounts in a 3¹/₁₆" diameter hole with 3 #6-32 screws spaced 120° on a 1.687" radius.

Cat. No.	Timing Range	Net Price
10000	60 Seconds	\$330.00
10001	5 Minutes	330.00
10002	15 Minutes	330.00
20001	30 Minutes	330.00
10003	60 Minutes	330.00
10004	5 Hours	330.00
10005	24 Hours	330.00

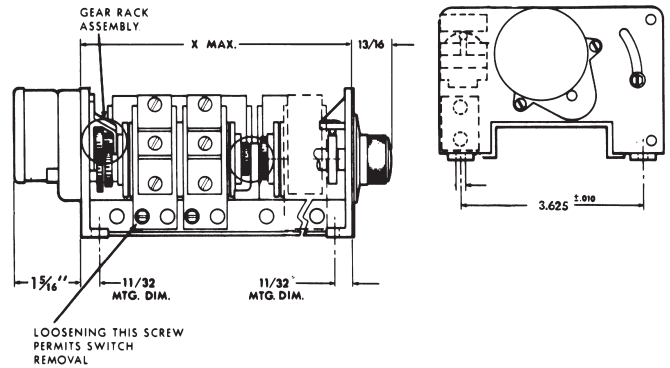
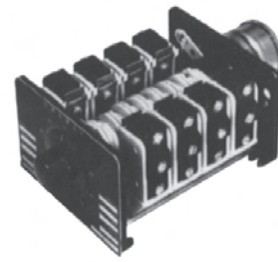

MULTIPOLE CYCLE TIMERS MODEL 540 SERIES

Versatile multi-pole cycle timer controls 2 through 10 independent circuits. Cams are individually adjustable over approximately 2 to 98% of the total cycle and can provide any desired sequence or program. Complete timer consists of chassis, motor and gear rack. Chassis incorporates baseplate, cams and switches. SPDT switches rated at 15 amperes non-inductive at 115 volts AC. Repeat accuracy ±1.8°. For 115 volts 60 Hz. UL recognized. Order motor and gear rack separately from table below.

Cat. No.	No. of Circuits	Dimension "X"	Net Price
10136	2	2 ⁷ / ₁₆ "	\$180.00
10137	4	3 ¹ / ₁₆ "	365.00
10138	6	4 ⁷ / ₁₆ "	365.00
10139	8	5 ⁷ / ₁₆ "	425.00
10140	10	6 ⁷ / ₁₆ "	440.00

HOW TO ORDER MODEL 540 CYCLE TIMERS

Choose basic chassis Model 540 from description above. Then select time cycle desired from selection chart and order appropriate motor and gear rack from the chart.

Example: For a 6 pole Model 540 with 60 second time cycle, order Cramer No. 10138 6 pole chassis plus Cramer No. 10159 gear rack plus Cramer No. 10145 motor.

SELECTION CHART—MODEL 540 CYCLE TIMERS

ORDER BASIC CHASSIS PLUS MOTOR & GEAR RACK TO GIVE DESIRED CYCLE TIME

Motor Speed	40 RPM	20 RPM	10 RPM	8 RPM	4 RPM	1 ¹ / ₂ RPM	3/8 RPM	1/8 RPM	1/16 RPM	1/45 RPM	3/8 RPH	1/8 RPH
Motor Code for Mod. 540	10141	10142	10143	10144	10145	10146	10147	10148	10149	10150	10151	10152
Cycle Time	Sec.	Sec.	Sec.	Sec.	Sec.	Min.	Min.	Min.	Min.	Hrs.	Hrs.	Hrs.
Gear Racks, Model 540												
10153	3.0	6.0	12.0	15.0	30.0	1.5	3.0	12.0	36.0	1.5	3.0	12.0
10159	6.0	12.0	24.0	30.0	60.0	3.0	6.0	24.0	72.0	3.0	6.0	24.0
10163	8.0	16.0	32.0	40.0	80.0	4.0	8.0	32.0	96.0	4.0	8.0	32.0



Hengstler Timers

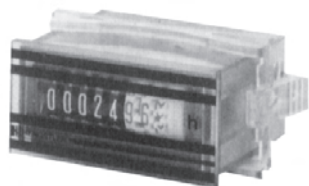

0891 TIME COUNTER
FRONT DIMENSIONS: 48MM×24MM

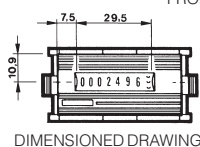

DIMENSIONED DRAWING

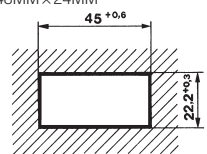

DIMENSIONS IN MM
ENQUIRE FOR SEALS

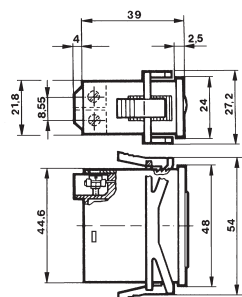

TYPE 0891 LOW-COST TIME COUNTER WITH DIN DIMENSIONS

These new low priced series time counters can easily be mounted. By using six different frames (A, B, C, D, E, and F), ordered separately, these units can be mounted in virtually any instrument or control panel.

The 7-segment display indicates the elapsed hours with a resolution of 0.01h. The display is highly legible, can run continuously for more than eleven years, and then restarts again at zero. As a safeguard against tampering, a reset is not available.

TECHNICAL DATA:

Drive:	Synchronous motor
Voltage Tolerance:	±10%
Power Consumption:	0.1VA at 24VAC 0.7VA at 230VAC
Line Frequency:	60Hz
Operating Temp.:	-10 to +50°C
Storage Temp.:	-25 to +70°C
Count Range:	0 to 99999.99h
Display:	Hours: white on black 1/100h: red on white
Digit Size:	5mm × 2mm, optical
Electrical Connection:	Screw terminals for max. 2.5mm ²
Attachment:	Clamping frame
Protection:	front: IP60; rear: screw terms. IP20
General Design:	to DIN VDE0435
Weight:	Approx. 50g.

TYPE 0891

Cat. No.	Supply Voltage	Frequency	Net Price
TIME COUNTERS			
G0-891-202	24 VAC	60Hz	\$53.11
G0-891-204	115 VAC	60Hz	53.11
G0-891-206	220 VAC	60Hz	53.11



TIME COUNTER
WITH PANEL FRAME ADAPTER PLATES
48MM×48MM

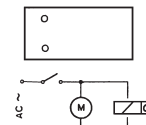

CONNECTION DIAGRAM

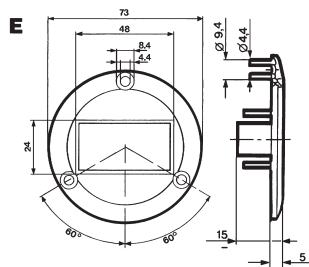
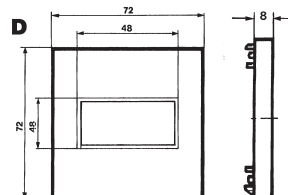
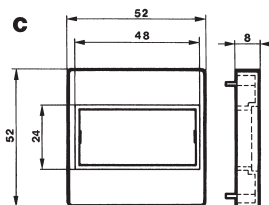
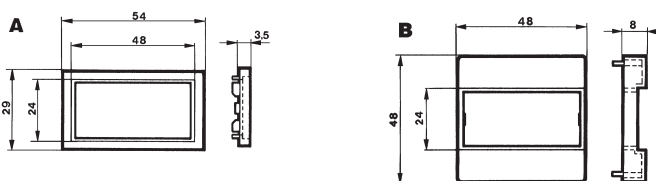

DIMENSIONS IN MM

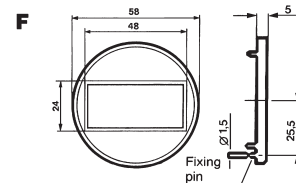

PANEL FRAME ADAPTER PLATES

0891 PANEL ADAPTER PLATES

Cat. No.	Fig.	Size	Cutout	Net Price
PANEL ADAPTER PLATES				
G2-405-218	A	54×29mm	50×25mm	\$4.19
G2-405-219	B	48×48mm	45×45mm	4.19
G2-405-220	C	52×52mm	45×45mm or 50mm dia.	4.19
G1-405-672	D	72×72mm	68×68mm	18.17
G2-405-223	E	73mm dia.	50mm dia.	4.19
G2-405-224	F	58mm dia.	50mm dia.	4.19

TOTALIZING COUNTERS "PICCOLO"

Cat. No.	Reset	No. of Digits	Counts Per Second	Volts	Net Price
G0-872-106	No	4	20	12 VDC	\$0.00
G0-872-107				24 VDC	55.90
G0-872-112			10	24 VAC	.00
G0-872-113				110 VAC	76.87
G0-873-106	Manual Push Button	4	20	12 VDC	88.05
G0-873-107				24 VDC	88.05
G0-873-112			10	24 VAC	83.85
G0-873-113				110 VAC	103.42
G0-874-106	No	5	20	12 VDC	74.07
G0-874-107				24 VDC	74.07
G0-874-112			10	24 VAC	00.00
G0-874-113				110 VAC	83.85
G0-875-106	Manual Push Button	5	20	12 VDC	92.24
G0-875-107				24 VDC	83.85
G0-875-112			10	24 VAC	111.81
G0-875-113				110 VAC	110.41
G0-876-106	No	6	20	12 VDC	.00
G0-876-107				24 VDC	.00
G0-876-112			10	24 VAC	.00
G0-876-113				110 VAC	00.00
G0-877-106	No	7	20	12 VDC	.00
G0-877-107				24 VDC	76.87
G0-877-112			10	24 VAC	101.77
G0-877-113				110 VAC	104.82

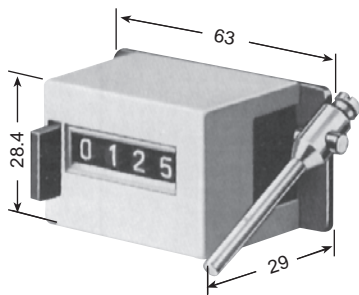

TYPE 125

TYPE 125 MECHANICAL REVOLUTION COUNTERS, STROKE COUNTERS WITH BUTTON RESET

TECHNICAL DATA

	Revolution Counter	Stroke Counter
Counting Mode	+(-)	+
Speed (max.)	1:1 = 1500 rpm	500/min.
Digit Size (white on black)	4.0 x 1.8mm (5-digit)	4.0 x 2.6mm (4-digit)
Reset	Button	Button

TYPE 125 MECHANICAL REVOLUTION COUNTERS, STROKE COUNTERS WITH BUTTON RESET

Cat. No.	Ratio	Actuator	Direction of Rotation	Net Price
REVOLUTION COUNTER—5-DIGIT				
G0-125-105	1:1	right hand	Bz	\$88.05
G0-125-106	1:1	right hand	Bw	88.05
G0-125-107	1:1	left hand	Bz	81.06
G0-125-108	1:1	left hand	Bw	88.05
STROKE COUNTER—5-DIGIT				
G0-125-305	1:1	right hand	Bz	92.24
G0-125-306	1:1	right hand	Bw	92.24
G0-125-307	1:1	left hand	Bz	83.85
G0-125-308	1:1	left hand	Bw	86.65

NOTE: Bz = Top coming; Bw = Top going

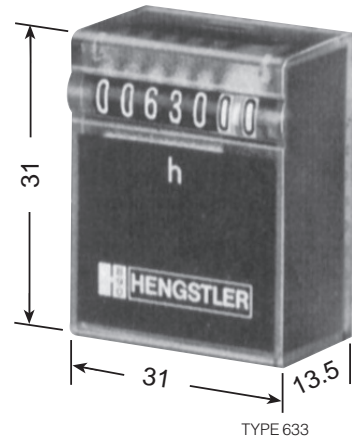

TYPE 633



TYPE 633 TIME COUNTERS "MINI-H"

These small elapsed-time meters are particularly suitable for integration into circuit boards with their encapsulated design. They can measure and indicate the useful life of electromechanical and electronic components and then store and indicate them for an unlimited period without any power consumption. They are notable for their high resistance to shock.

TECHNICAL DATA:

Current Consumption, Continuous:	2 mA
Pulse Duration every 36 sec.:	31 ms
Temperature Range:	-10°C to +60°C
Number of Digits:	7
General Design:	to DIN VDE 0435
Protection Class:	IP 66 .7 & .8 only front IP 00 terminals
Voltage Tolerance:	5V ±10%/12V ±20%

TYPE 633 TIME COUNTERS "MINI-H"

Cat. No.	Reset	Ohms	Pulse Current	Volts	Net Price
G0-633-031	No	140	36 mA	5 VDC	\$81.06
G0-633-032		720	17 mA	12 VDC	81.06
G0-633-731	No	140	36 mA	5 VDC	86.65
G0-633-732		720	17 mA	12 VDC	90.84
G0-633-831	No	140	36 mA	5 VDC	67.08
G0-633-832		720	17 mA	12 VDC	92.24

1-800-56-SONIC
www.e-sonic.com