



FLUSH

SELF-CLINCHING

FASTENERS

BULLETIN

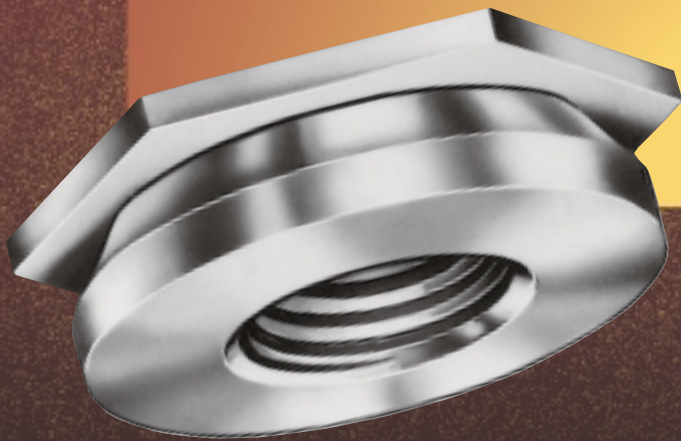

PEMSERT® SELF-CLINCHING FLUSH FASTENERS

PEMSERT self-clinching flush nuts are designed to be completely flush in sheets as thin as .060 in. / 1.5 mm.

These fasteners are ideal for applications where a thin sheet requires load-bearing threads but still must remain smooth, with no protrusions on either surface. The PEM flush nut can be installed easily by squeezing it into a round, punched or drilled hole in metal sheets. When the fastener is installed, both the top and the bottom of the sheet remain smooth, enhancing the functional and cosmetic qualities of the entire assembly. PEMSERT self-clinching flush nuts can be installed in metal sheets before bending and forming. This can provide strong threads in places which would be inaccessible for installation after chassis are formed.

PEM flush fasteners are strong too. The hexagonal head along with the proven PEM self-clinching design ensures high axial and torsional strength and PEMSERT Type F fasteners meet US NASM45938/4 specifications.*

**To meet national aerospace standards and to obtain testing documentation, product must be ordered to NASM45938/4 specifications. Consult our Marketing department for a complete Military Specification and National Aerospace Standards Reference Guide (Bulletin NASM) or check our web site.*

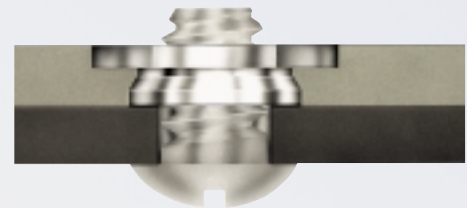

Part Number Designation

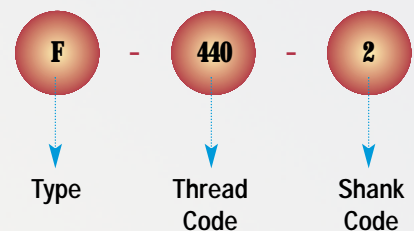

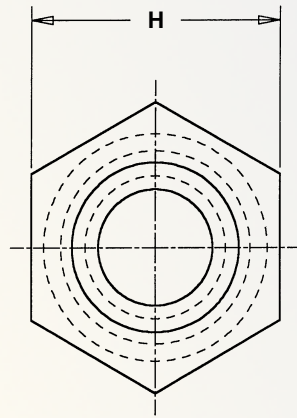

Profile for
-1 shank code.

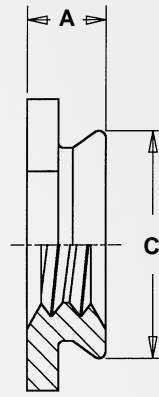

Profile for -2, -3, -4,
& -5 shank codes.

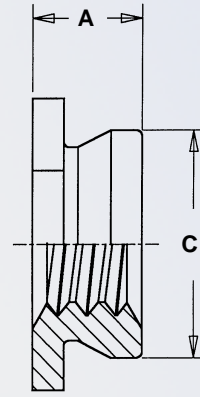

Clinching profile may vary.

All dimensions are in inches.

UNIFIED	Thread Size	Type	Thread Code	Shank Code	A Max.	Sheet Thickness	Hole Size In Sheet +.003 -.000	C Max.	H Nom.	Min. Dist. Hole C/L To Edge
	.086-56 (#2-56)	F	256	1	.060	.060-.090	.172	.171	.188	.23
				2	.090	.091-UP				
	.112-40 (#4-40)	F	440	1	.060	.060-.090	.172	.171	.188	.23
				2	.090	.091-UP				
	.138-32 (#6-32)	F	632	1	.060	.060-.090	.213	.212	.250	.27
				2	.090	.091-UP				
	.164-32 (#8-32)	F	832	1	.060	.060-.090	.290	.289	.312	.28
				2	.090	.091-UP				
	.190-32 (#10-32)	F	032	1	.060	.060-.090	.312	.311	.343	.31
2				.090	.091-UP					
.250-20 (1/4-20)	F	0420	3	.120	.125-.155	.344	.343	.375	.34	
			4	.151	.156-.186					
			5	.182	.187-UP					

All dimensions are in millimeters.

METRIC	Thread Size x Pitch	Type	Thread Code	Shank Code	A Max.	Sheet Thickness	Hole Size In Sheet +0.08	C Max.	H Nom.	Min. Dist. Hole C/L To Edge
	M2x0.4	F	M2 ^{NS}	1	1.53	1.53-2.3	4.37	4.35	4.8	6
				2	2.3	2.32-UP				
	M2.5x0.45	F	M2.5	1	1.53	1.53-2.3	4.37	4.35	4.8	6
				2	2.3	2.32-UP				
	M3x0.5	F	M3	1	1.53	1.53-2.3	4.37	4.35	4.8	6
				2	2.3	2.32-UP				
	M4x0.7	F	M4	1	1.53	1.53-2.3	7.37	7.35	7.9	7.2
				2	2.3	2.32-UP				
	M5x0.8	F	M5	1	1.53	1.53-2.3	7.92	7.9	8.7	8
2				2.3	2.32-UP					
M6x1	F	M6	3	3.05	3.18-3.94	8.74	8.72	9.5	8.8	
			4	3.84	3.96-4.72					
			5 ^{NS}	4.63	4.75-UP					

NS Not stocked. Available on special order.

FASTENER MATERIAL: 300 Series Stainless Steel.

FINISH: Passivated and/or tested per ASTM A380.

FOR USE IN SHEET HARDNESS: 70 or less on the Rockwell "B" Scale.

THREADS: Internal, ANSI B1.1, 2B / ANSI / ASME B1.13M, 6H.

INSTALLATION

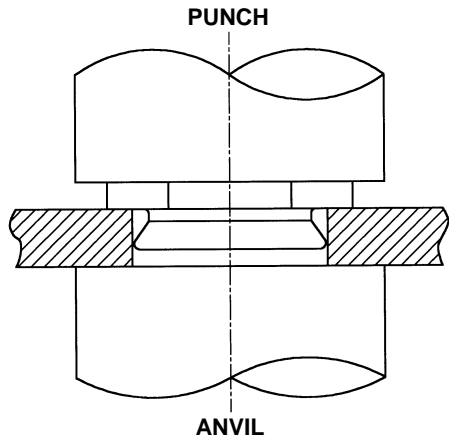

- 1.** Punch or drill properly sized mounting hole in sheet. Do not perform any secondary operations such as deburring.
- 2.** Place shank of fastener into mounting hole, preferably the punch side.
- 3.** With punch and anvil surfaces parallel, apply sufficient squeezing force only to embed hexagonal head flush in sheet. The metal displaced by the head flows evenly and smoothly around the back-tapered shank of the fastener, securely locking it into place with high pullout resistance while at the same time, the embedded hexagonal head provides high torque resistance.

PERFORMANCE DATA⁽¹⁾

UNIFIED	Thread Code	Shank Code	Axial Tensile Strength (lbs.)	Max. Screw ⁽²⁾ Tightening Torque (in. lbs.)	Test Sheet Material			
					5052-H34 Aluminum		Cold-rolled Steel	
					Installation (lbs.)	Pushout (lbs.)	Installation (lbs.)	Pushout (lbs.)
256	1	2	130	1.50	2000	200	3000	200
	2							
440	1	2	165	2.50	2000	200	3000	200
	2							
632	1	2	190	3.50	2000	200	3000	200
	2							
832	1	2	230	5.25	2000	240	4000	240
	2							
032	1	2	280	7.50	2500	240	4000	240
	2							
0420	3	5	1035	36	3500	640	4500	840
	4							
	5							

METRIC	Thread Code	Shank Code	Axial Tensile Strength (kN)	Max. Screw ⁽²⁾ Tightening Torque (N·m)	Test Sheet Material			
					5052-H34 Aluminum		Cold-rolled Steel	
					Installation (kN)	Pushout (N)	Installation (kN)	Pushout (N)
M2	1	2	0.57	0.16	8.9	890	13.3	890
	2							
M2.5	1	2	0.68	0.23	8.9	890	13.3	890
	2							
M3	1	2	0.85	0.36	8.9	890	13.3	890
	2							
M4	1	2	1	0.58	8.9	1068	17.8	1068
	2							
M5	1	2	1.3	0.88	11.1	1068	17.8	1068
	2							
M6	3	5	4.5	3.7	15.6	2847	20	3736
	4							
	5							

(1) The installation and pushout values reported are averages when all installation specifications and procedures are followed. Variations in mounting hole size, sheet material and installation procedure will affect this data. Performance testing of this product in your application is recommended. We will be happy to provide samples for this purpose.

(2) Head may bend and/or fail if screw is over-torqued beyond these values.

Specifications subject to change without notice.

For the Name of the Authorized PEM distributor nearest you...



Visit us at our PEMNETSM web site
www.pemnet.com or call
1-800-523-5321 (USA Only)

PEM[®] FASTENING SYSTEMS

a PennEngineering[®] company

World Headquarters:

5190 Old Easton Road
 Danboro, PA 18916 USA
 E-mail: pem@pemnet.com
 Tel: 215-766-8853 • Fax: 215-766-3634



U.K. And Europe:

Kirk Sandall Industrial Estate
 Doncaster, South Yorkshire • DN3 1QR, England
 E-mail: arconix-uk@arconix.com
 Tel: 01302 886961 • Fax: 01302 885341

Asia/Pacific:

Citipoint Industrial Complex
 152 Paya Lebar Road #03-06 • Singapore 409020
 E-mail: arconix-sing@arconix.com
 Tel: 65 745 0660 • Fax: 65 745 2400

Printed in U.S.A.
 CAGE-46384