

EN - For pricing and availability in your local country please visit one of the below links:

DE - Informationen zu Preisen und Verfügbarkeit in Ihrem Land erhalten Sie über die unten aufgeführten Links:

FR - Pour connaître les tarifs et la disponibilité dans votre pays, cliquez sur l'un des liens suivants:

[146 103](#)

[26-4401-24S](#)

[86-3-24](#)

[77-MIP-8](#)

[17-1372](#)

[17-1588-06](#)

[17-310-01](#)

[143-015-01](#)

[17-10150](#)

[17-10250](#)

EN

This Datasheet is presented by
the manufacturer

DE

Dieses Datenblatt wird vom
Hersteller bereitgestellt

FR

Cette fiche technique est
présentée par le fabricant

WPI

**WPI® Connectors
Accessories and
Cable Assemblies**



**...featuring connector
lines formerly
manufactured by
AMPHENOL**



Table of Contents

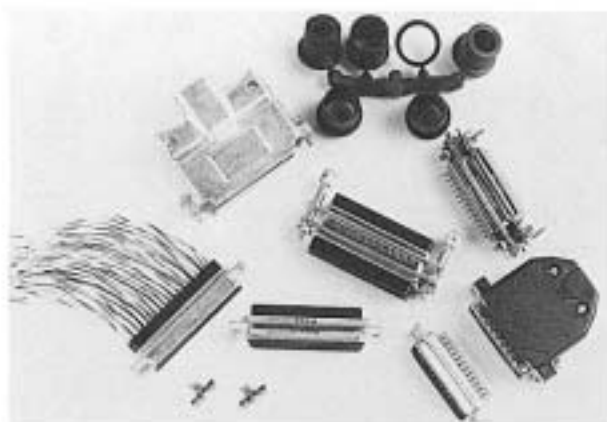

**d-subminiature connectors
rear-release & poke home®
17 / 117 / 177 / 777 series
formerly Amphenol
section 1**

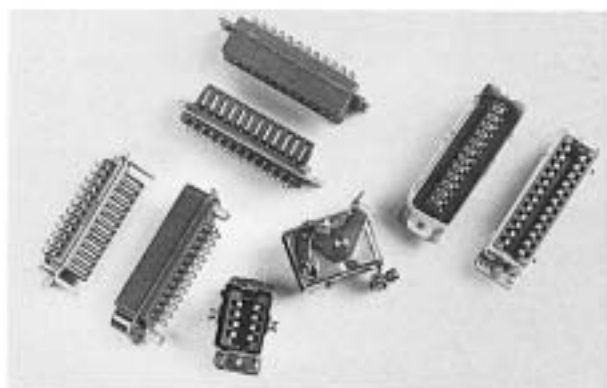

**Blue Ribbon
rack & panel / cable to panel
heavy duty connectors
26 series
formerly Amphenol
section 2**

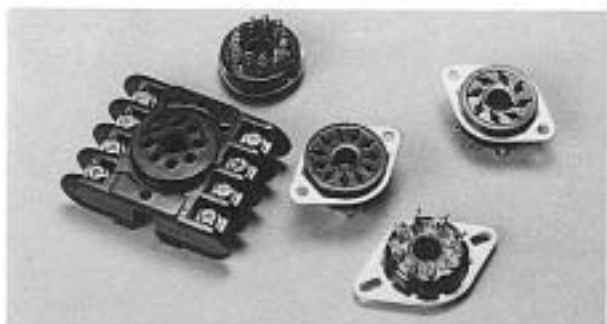

**tube / relay sockets
77 / 78 & 146 series
formerly Amphenol
section 3**



**commercial plugs & accessories
78 & 86 series
formerly Amphenol
section 4**

**DISTRIBUTORS . . . WPI® connectors are distributed internationally.
For distributors in your area, contact WPI Marketing & Sales.**



Table of Contents



microphone connectors
80 / 91 & 91Q series
formerly Amphenol
section 5

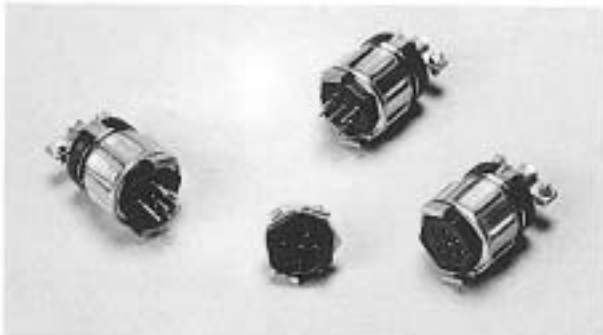

hexagonal connectors
126 series
formerly Amphenol
section 6

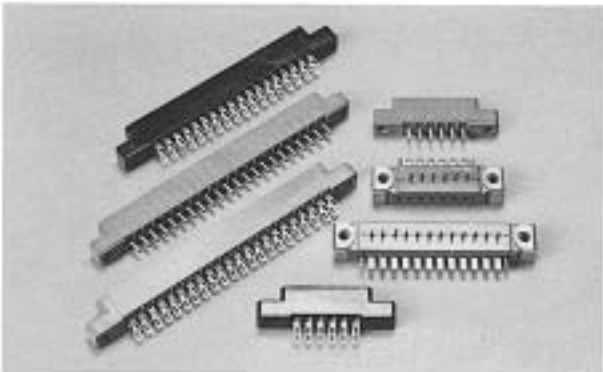

printed circuit connectors
133 / 143 & 225 series
formerly Amphenol
section 7

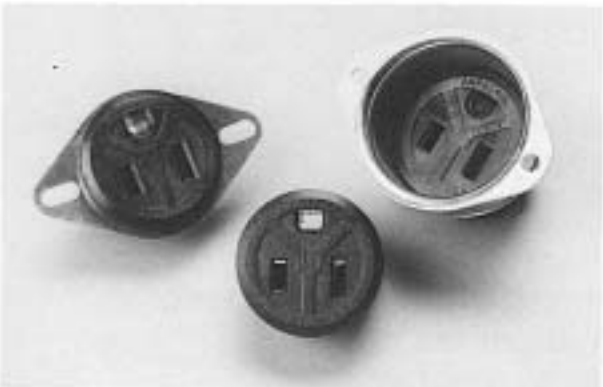

125 volt plugs & receptacles
160 series
formerly Amphenol
section 8

DISTRIBUTORS . . . WPI® connectors are distributed internationally.
For distributors in your area, contact WPI Marketing & Sales.



Table of Contents



**microphone connectors
80 / 91 & 91Q series
formerly Amphenol
section 5**

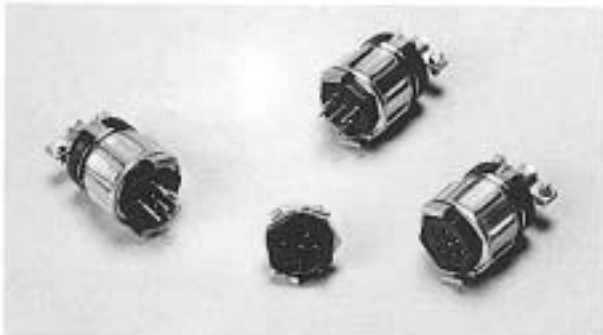

**hexagonal connectors
126 series
formerly Amphenol
section 6**

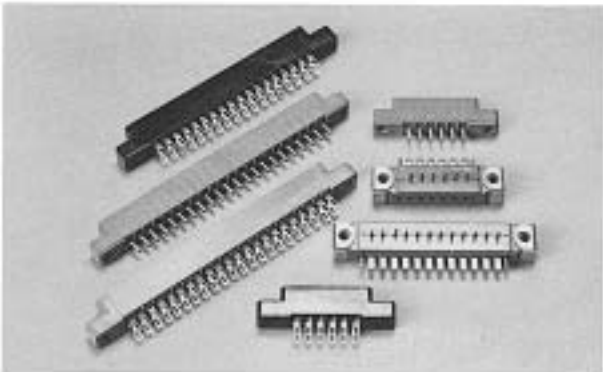

**printed circuit connectors
133 / 143 & 225 series
formerly Amphenol
section 7**

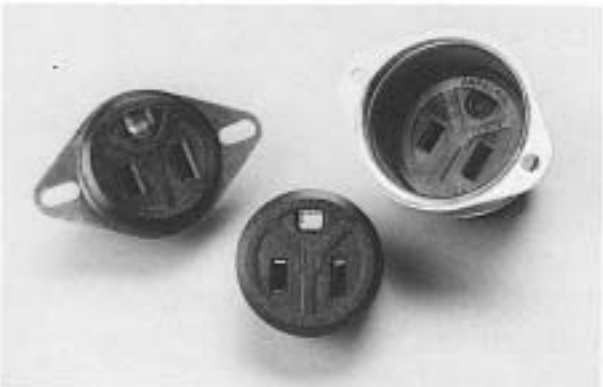

**125 volt plugs & receptacles
160 series
formerly Amphenol
section 8**

**DISTRIBUTORS . . . WPI® connectors are distributed internationally.
For distributors in your area, contact WPI Marketing & Sales.**



Table of Contents



strip, Tiny Tim® & Mighty-Mite®
connectors
220 / 221 / 222 & 223 series
formerly Amphenol
section 9



military audio connectors
section 10



military u-type connectors
section 11

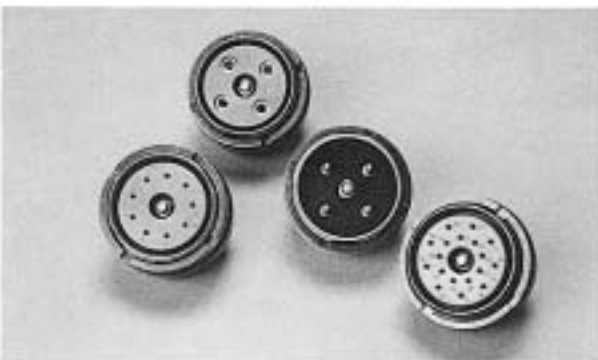

military mw power connectors
section 12

DISTRIBUTORS . . . WPI® connectors are distributed internationally.
For distributors in your area, contact WPI Marketing & Sales.



Table of Contents



**military uw power connectors
section 13**



**military connector accessories
section 14**



**military special-order
section 15**



**termination tooling
for 17 / 117 / 220 series
section 16**

**DISTRIBUTORS . . . WPI® connectors are distributed internationally.
For distributors in your area, contact WPI Marketing & Sales.**

WPI® d-subminiature connectors

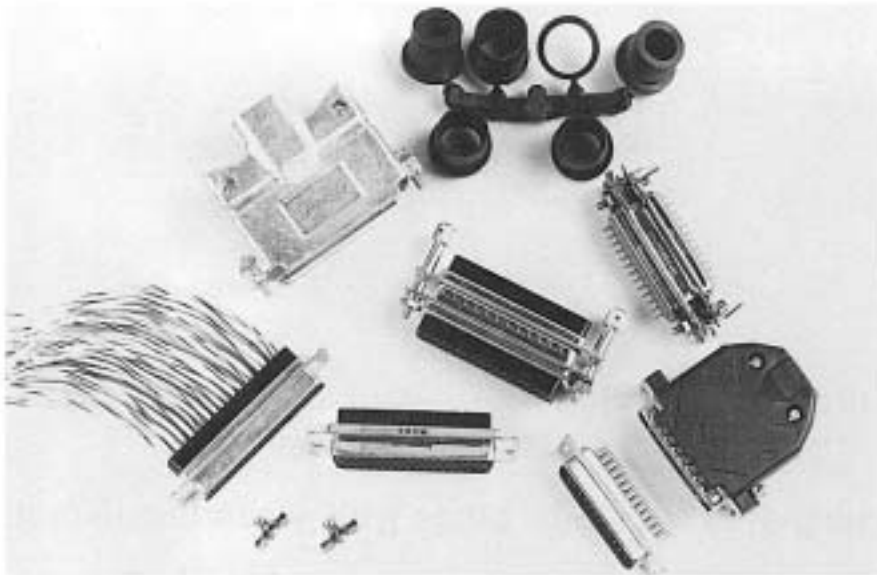

**interchangeable and intermateable connectors for
commercial, industrial and military applications**

d-subminiature connectors have many advantages:

- lightweight / low profile
- economical
- "D" shape assures proper mating / polarization
- meet EIA standards RS 232C & RS 449 for data input/output
- high contact density
- rugged construction
- removable contacts for field repair
- high-speed crimp termination
- rack & panel / cable to cable / cable to panel applications
- intermateable / intermountable with competitive d-sub
- EMI / RFI shielding applications available



WPI - Salem Division
23 Front Street, Salem, NJ 08079 U.S.A.
phone (609) 935-7601
fax (609) 935-0102 twx (510) 680-4750
country code 1

rear-release d-sub

17RR series

economical crimp connector • high volume production
conforms EIA standard RS 232 C - RS 449

rear-release d-sub connectors

Reliable, high density rear-release connectors offer superior features and low installation cost over other popular crimp and solder "D" types. Contacts are stamped and formed, and provide an insulation crimp feature which provides strain relief and insures the integrity of the crimp. The contacts are loaded with fingertip pressure and removed with a simple tool from the wired side (the rear of the connector). The contact and crimp are surrounded by the dielectric which eliminates the need for potting or sleeving to protect against shorting.

- Economical crimp contact (High speed stripper crimp tool and manual hand crimp tool available).
- Crimp contacts with insulation support feature.
- Shrouded contact and crimp protect against shorting or arcing.
- Removable contact.
- 2 pieces black thermoplastic UL 94 VO rated insulator.
- 5 shell sizes E, A, B, C, D.
- 5 configurations 9, 15, 25, 37, 50.
- Polarization by "D" shape.
- Hoods and locking accessories are available (see section 1 page 6-7)
- UL recognized (file #E115487)

specifications

Shell: EM/ESD configuration.
Bright tin plating and
grounding indents on plug
front shells.

Dielectric: Two piece black
thermoplastic UL 94 VO rated

Contacts: stamped and formed

Plating: .000020 inches gold
over nickel

Crimp tensile strength:

20 AWG = 18 lb

22 AWG = 15 lb

24 AWG = 10 lb

26 AWG = 7 lb

30 AWG = 3 lb

Wire types: 20 to 30 AWG

max. insulator over

diameter .050(1.27)

Temperature: -67°F (-55°C) to

+257°F (+125°C)

Voltage rating: 500 VAC

(sea level)

Current rating: 5A

Section 1 Page 2

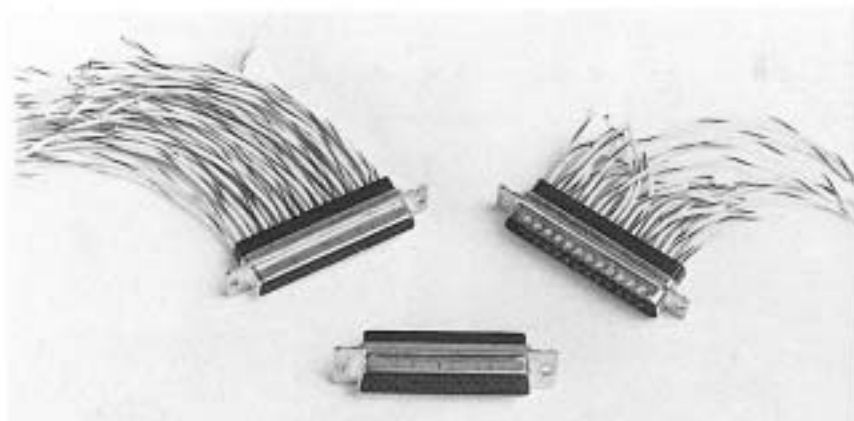

order information

Connector housings and contacts
to be ordered separately

tin plated housings, plugs with grounding indents

Contacts	WPI Receptacle	AMP Equivalent	WPI Plug	AMP Equivalent
9	177-RRE-9S	205203-3	777-RRE-9P	205204-4
15	177-RRA-15S	205205-2	777-RRA-15P	205206-3
25	177-RRB-25S	207463-1	777-RRB-25P	207464-2
37	177-RRC-37S	205209-2	777-RRC-37P	205210-3
50	177-RRD-50S	205211-2	777-RRD-50P	205212-3

zinc plated housings with gold iridite

Contacts	WPI Receptacle	AMP Equivalent	WPI Plug	AMP Equivalent
9	117-RRE-9S	205203-1	117-RRE-9P	205204-1
15	117-RRA-15S	205205-1	117-RRA-15P	205206-1
25	117-RRB-25S	205207-1	117-RRB-25P	205208-1
37	117-RRC-37S	205209-1	117-RRC-37P	205210-1
50	117-RRD-50S	205211-1	117-RRD-50P	205212-1

contacts

Wire Size	Description	WPI Part Number Bag of 100	WPI Part Number Reel of 10,000
20-24	Female	17-RRD1-F02-100	17-RRD1-F02-10K
20-24	Male	17-RRD1-M02-100	17-RRD1-M02-10K
24-30	Female	17-RRD2-F02-100	17-RRD2-F02-10K
24-30	Male	17-RRD2-M02-100	17-RRD2-M02-10K

NOTES:

1. FOR LEFT FEED REEL — 17 - RRDx - X02 - 10KG
2. CONSULT FACTORY FOR ALTERNATE PLATING REQUIREMENTS

WPI - Salem Division
23 Front Street, Salem, NJ 08079 U.S.A.
phone (609) 935-7601
fax (609) 935-0102 twx (510) 680-4750
country code 1



rear-release d-sub

tin plated housings, plugs with grounding indents

Contacts	WPI Receptacle	WPI Plug
9	177-RRE-9S-CTF	777-RRE-9P-CTF
15	177-RRA-15S-CTF	777-RRA-15P-CTF
25	177-RRB-25S-CTF	777-RRB-25P-CTF
37	177-RRC-37S-CTF	777-RRC-37P-CTF
50	177-RRD-50S-CTF	777-RRD-50P-CTF

order information

* Contacts packaged with connector housings

zinc plated housings with gold iridite

Contacts	WPI Receptacle	WPI Plug
9	117-RRE-9S-CTF	117-RRE-9P-CTF
15	117-RRA-15S-CTF	117-RRA-15P-CTF
25	117-RRB-25S-CTF	117-RRB-25P-CTF
37	117-RRC-37S-CTF	117-RRC-37P-CTF
50	117-RRD-50S-CTF	117-RRD-50P-CTF

* Gold flashed contacts included with housings
Consult factory for alternate plating requirements

dimensions

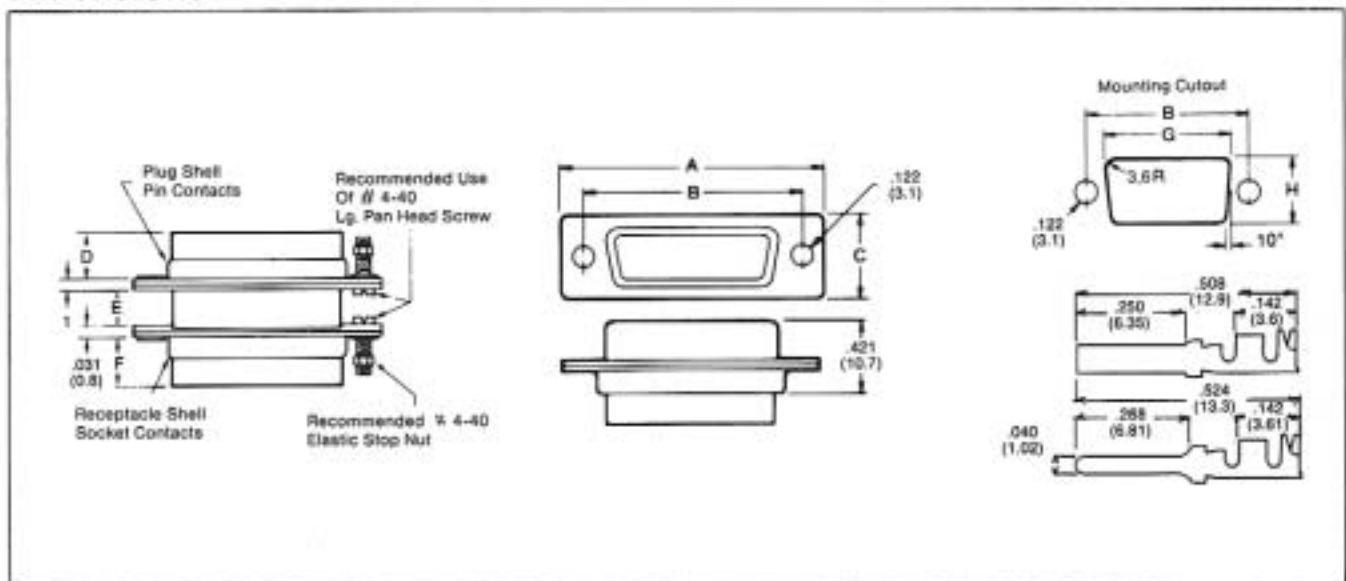

contact arrangements



	A max.	B	C max.	D	E	F	G (Min)		H (Min)	
							Back Mtg	Front Mtg	Back Mtg	Front Mtg
E	1.240 (31.5)	.984 (25)	.516 (13.1)	.358 (9.1)	.232 (5.9)	.358 (9.1)	.799 (20.3)	.831 (21.1)	.449 (11.4)	.504 (12.8)
A	1.567 (39.8)	1.312 (33.3)	.516 (13.1)	.358 (9.1)	.232 (5.9)	.358 (9.1)	1.118 (28.4)	1.161 (29.5)	.449 (11.4)	.504 (12.8)
B	2.110 (53.6)	1.852 (47.05)	.516 (13.1)	.358 (9.1)	.232 (5.9)	.358 (9.1)	1.654 (42)	1.701 (43.2)	.449 (11.4)	.504 (12.8)
C	2.756 (70)	2.500 (63.5)	.516 (13.1)	.358 (9.1)	.232 (5.9)	.358 (9.1)	2.303 (58.5)	2.346 (59.6)	.449 (11.4)	.504 (12.8)
D	2.661 (67.6)	2.406 (61.1)	.626 (15.9)	.358 (9.1)	.232 (5.9)	.358 (9.1)	2.209 (56.1)	2.283 (58)	.559 (14.2)	.618 (15.7)

All dimensions: inches (millimeters)



WPI - Salem Division
23 Front Street, Salem, NJ 08079 U.S.A.
phone (609) 935-7601
fax (609) 935-0102 twx (510) 680-4750
country code 1

original Poke-Home[®] d-sub 17 series

WPI original poke-home blocks can accept the wide range of contact types described on this page.

Poke Home[®] d-sub connectors

A removable contact type connector that meets most commercial requirements. The connector is available with crimp type contacts, solder type, and printed circuit types in both .023 and .040 inch diameter pintails. The .040 pintail is available in two lengths or with right angles.

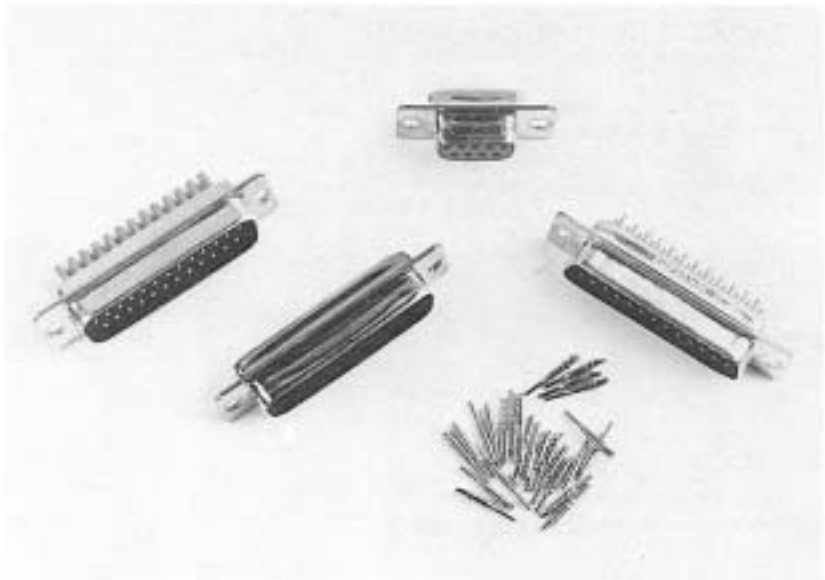

Standard crimp type contacts

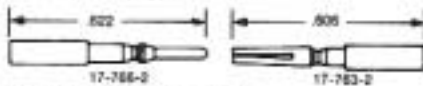

Standard solder type contacts



Pintail contacts for P.C. mounting

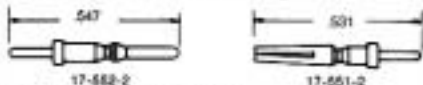

Right angle .040 dia. pintails.

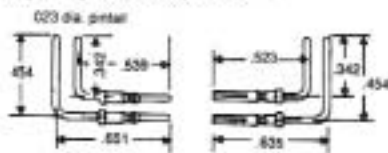

17-1198-2 (short), 17-1207-2 (long) pin
17-1205-2 (short), 17-1209-2 (long) socket

Optional contacts

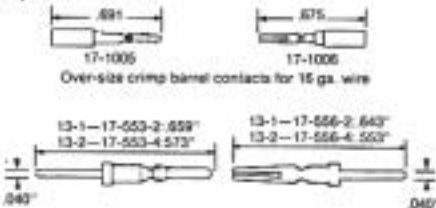

specifications

Temperature ranges:
-67°F (-55°C) to
+257°F (+125°C)
Current rating: 7.5 A
Voltage rating:
500 VAC (RMS) at sea level
150 VAC (RMS) at 90,000 feet
Dielectric: Zytel 101
nylon per Mil M-20693

Shells: Steel clear chromated over zinc.
Gold iridite finish available on
request per QQP416A Type II
Contacts: Crimp - gold over nickel plated
copper alloy
Solder - gold over nickel plated copper
alloy
Wire size: Solder: up to #20
Crimp #20, #22, and #24AWG

contact arrangements



Number of Contacts	Receptacle	Receptacle with Float Bushings	Plug
9	17-300-1	17-785	17-301-1
15	17-302-1	17-793	17-303-1
25	17-304-1	17-789	17-325-1
37	17-306-1	17-797	17-327-1
50	17-308-1	17-1001	17-329-1

Connectors above have zinc plated clear chromate steel shells. For gold iridite finish, add one number to suffix. Examples: 17-300-2, 17-786. See page 5 for optional finish.

Number of Contacts	Crimp Type Includes specified number of standard crimp contacts		Solder Type Includes specified number of standard solder contacts	
	Receptacle Socket Contacts	Plug Pin Contacts	Receptacle Socket Contacts	Plug Pin Contacts
9	17-10090-1	17-20090-1	17-10090	17-20090
15	17-10150-1	17-20150-1	17-10150	17-20150
25	17-10250-1	17-20250-1	17-10250	17-20250
37	17-10370-1	17-20370-1	17-10370	17-20370
50	17-10500-1	17-20500-1	17-10500	17-20500

Number of Contacts	PC Board Type Includes specified number of pintail contacts inserted in place			
	Receptacle With 17-551-02 Socket Contacts	Plug With 17-552-02 Pin Contacts	Receptacle With 17-556-XX Socket Contacts	Plug With 17-553-XX Pin Contacts
9	17-10090-11	17-20090-11	17-10090-13-XX	17-20090-13-XX
15	17-10150-11	17-20150-11	17-10150-13-XX	17-20150-13-XX
25	17-10250-11	17-20250-11	17-10250-13-XX	17-20250-13-XX
37	17-10370-11	17-20370-11	17-10370-13-XX	17-20370-13-XX
50	17-10500-11	17-20500-11	17-10500-13-XX	17-20500-13-XX

Connectors can also be ordered without contacts for use with bulk packed contacts in wire automatic stripping machines. Contact sales office nearest you.



EMI/ESD accommodation

All shells on housings can be supplied with bright tin finish and grounding indents on plug front shells to accommodate grounding.

Metal and plated plastic hoods and clamps are also available in many sizes to shield exposed terminations.

order information housings

17-30X-3 for bright tin - receptables only

17-30X-3 (439) for bright tin and grounding indents - plugs only

assembled connectors

17-12XXX-XX (receptacle) for bright tin

17-22XXX-XX (439) (plugs) for bright tin with grounding indents

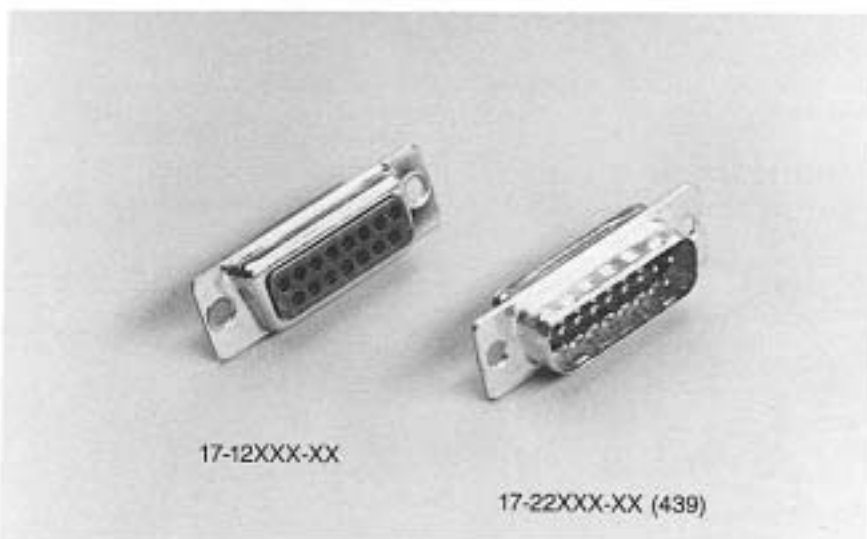

order information

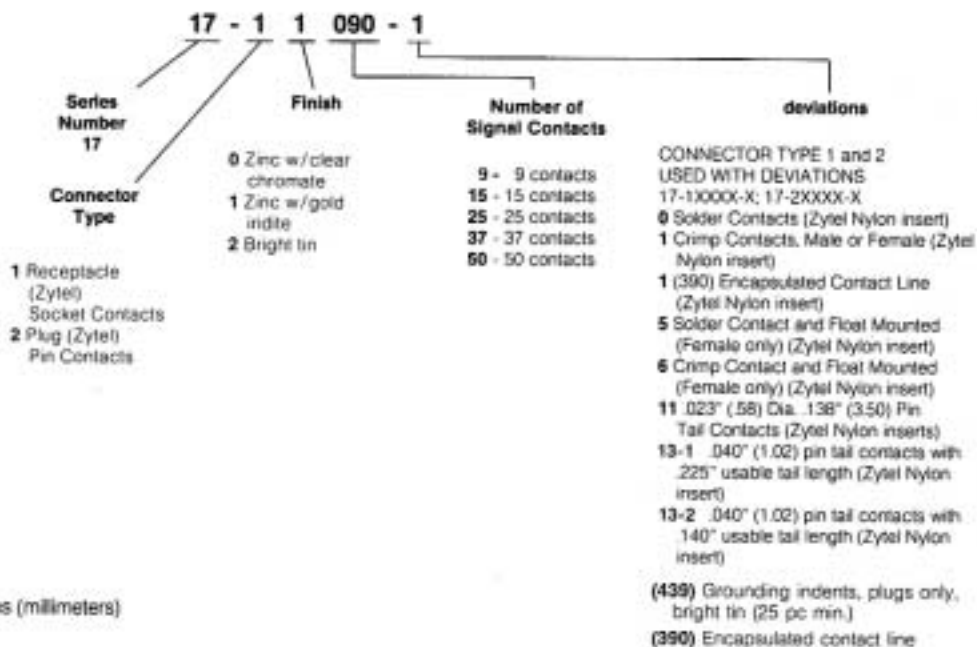

All dimensions: inches (millimeters)







WPI - Salem Division
23 Front Street, Salem, NJ 08079 U.S.A.
phone (609) 935-7601
fax (609) 935-0102 twx (510) 680-4750
country code 1

WPI® d-subminiature accessories quick reference chart

Accessories	Page	Shell size Configuration	E 9	A 15	B 25	C 37	D 50	
	8	Metallic straight cable housing with cable clamp	clear finish	17-310-1	17-311-1	17-312-1	17-313-1	17-314-1
			Gold iridite	17-310-2	17-311-2	17-312-2	17-313-2	17-314-2
	8	2 piece screw lock back shells with cable clamp (side or top cable entry)	17-1370	17-1371	17-1372	17-1373	17-1374	
	9	Two piece plastic (UL) housing with cable clamp (side or top cable entry)	with standard screw	17-1587-6	17-1588-6	17-1589-6	17-1590-6	17-1591-6
			with long jack screw	17-1587-9	17-1588-9	17-1589-9	17-1590-9	17-1591-9
	9	Die cast metal two-piece back shells - screw lock with internal cable clamp - top entry	17-1657-9	17-1657-15	17-1657-25	17-1657-37	17-1657-50	
	10	Plastic two piece back shells - screw lock with internal cable clamp - top entry	17-1724-1	17-1725-1	17-1726-1	17-1727-1	17-1728-1	
	10	Metalized plastic two piece back shells - screw lock with internal cable clamp - top entry	17-1724-2	17-1725-2	17-1726-2	17-1727-2	17-1728-2	

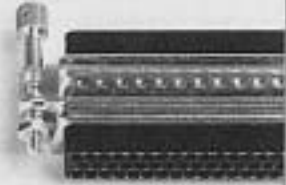

Accessories	Page	Shell size Configuration	E 9	A 15	B 25	C 37	D 50	
	11	Spring Latch	clear finish	17-529	17-529	17-529	17-529	17-770
			Gold Iridite	17-847	17-847	17-847	17-847	17-850
	11	Screw Lock Assembly	17-768	17-768	17-768	17-768	17-769	
	11	Jack Socket	17-893	17-893	17-893	17-893	17-893	
		Jack Screw	17-894	17-894	17-894	17-894	17-894	
		Jack Assembly	17-895	17-895	17-895	17-895	17-895	
	Sec. 15 Pg. 2	D-type RS232 connector field service kit	17RR-232K					



WPI - Salem Division
 23 Front Street, Salem, NJ 08079 U.S.A.
 phone (609) 935-7601
 fax (609) 935-0102 twx (510) 680-4750
 country code 1

d-subminiature accessories

cable clamp assembly

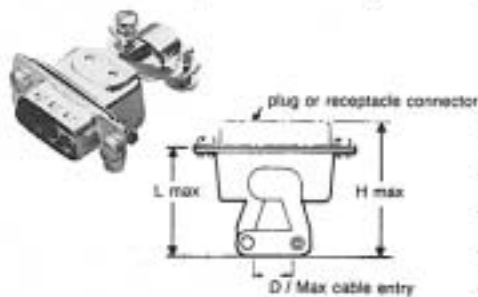

Shell size	Order No.		D	H	L
	clear chromate finish	gold iridite finish			
E	17-310-1	17-310-2	.406(10.30)	1.358(34.50)	1.094(27.80)
A	17-311-1	17-311-2	.406(10.30)	1.358(34.50)	1.094(27.80)
B	17-312-1	17-312-2	.594(15.10)	1.390(35.30)	1.126(28.60)
C	17-313-1	17-313-2	.720(18.30)	1.390(35.30)	1.126(28.60)
D	17-314-1	17-314-2	.720(18.30)	1.390(35.30)	1.126(28.60)

hoods with external clamps

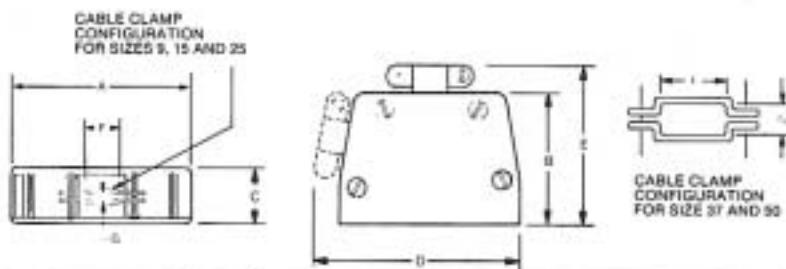

Shell Size	Order No.	Dimensions						
		A Max.	B	C Max.	D Max.	E Max.	F Max.	G Max.
E	17-1370	1.240(31.50)	1.291(32.80)	.661(16.80)	1.559(39.60)	1.638(41.60)	.252(6.40)	.181(4.60)
A	17-1371	1.567(39.80)	1.500(38.10)	.661(16.80)	1.898(47.90)	1.846(46.90)	.374(9.50)	.220(5.60)
B	17-1372	2.110(53.60)	1.500(38.10)	.661(16.80)	2.433(61.80)	1.350(47.00)	.449(11.40)	.299(7.60)
C	17-1373	2.756(70.00)	1.594(40.50)	.661(16.80)	3.272(83.10)	2.134(54.20)	.650(16.50)	.358(9.10)
D	17-1374	2.634(50.00)	1.594(40.50)	.780(19.80)	3.177(80.70)	2.134(54.20)	.650(16.50)	.461(11.70)



hoods with internal cable clamps

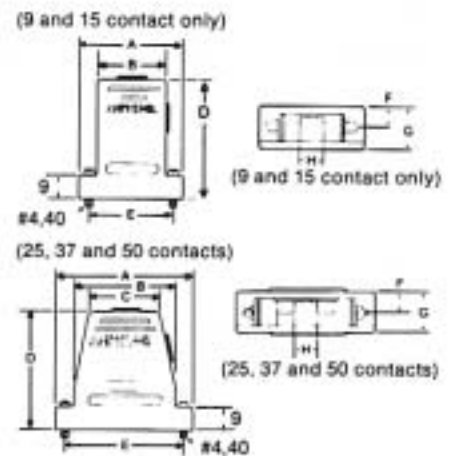

Shell Size	Order No. Standard Screw	Order No. Long Jack Screw	A	B	C	D	E	F	G	H
E	17-1587-6	17-1587-9	1.358(34.5)	.760(19.3)	—	1.610(40.9)	.984(25.0)	.321(8.15)	.642(16.3)	.374(6.4)
A	17-1588-6	17-1588-9	1.689(42.9)	1.087(27.6)	—	1.890(48.0)	1.311(33.3)	.321(8.15)	.642(16.3)	.374(9.5)
B	17-1589-6	17-1589-9	2.228(56.6)	1.626(41.3)	1.230(32.5)	1.890(48.0)	1.850(47.0)	.312(8.15)	.252(16.3)	.374(9.5)
C	17-1590-6	17-1590-9	2.874(73.0)	2.222(57.7)	1.402(35.6)	2.091(53.1)	2.500(63.5)	.321(8.15)	.252(16.3)	.531(13.5)
D	17-1591-6	17-1591-9	2.280(70.6)	2.181(55.4)	1.567(39.8)	2.091(53.1)	2.406(61.1)	.380(9.65)	.760(19.3)	.531(13.5)

die cast two piece backshell

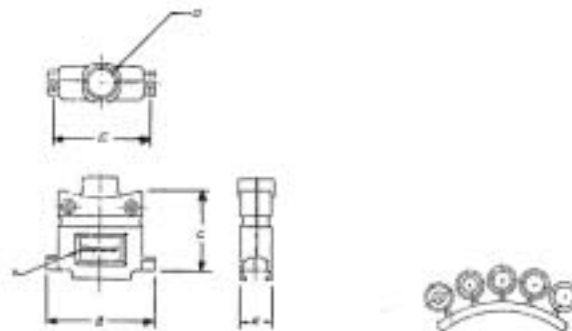

screw lock with
internal cable clamp
- top entry

Shell Size	Order No.	A	B	C	D	E	Cable Dia. Min/Max
E	17-1657-9	.620(15.75)	1.225(31.12)	1.465(37.21)	.400(10.16)	.984(25.00)	.190/.350(4.83/8.89)
A	17-1657-15	.620(15.75)	1.540(39.12)	1.600(40.64)	.400(10.16)	1.312(33.32)	.190/.350(4.83/8.89)
B	16-1657-25	.620(15.75)	2.090(53.09)	1.550(39.37)	.525(13.34)	1.857(47.17)	.190/.460(4.83/11.68)
C	17-1657-37	.620(15.75)	2.750(69.85)	1.800(45.72)	.725(18.42)	2.500(63.50)	.300/.680(7.62/17.27)
D	17-1657-50	.730(18.54)	2.645(67.18)	1.800(45.72)	.725(18.42)	2.406(61.11)	.300/.680(7.62/17.27)



WPI - Salem Division
23 Front Street, Salem, NJ 08079 U.S.A.
phone (609) 935-7601
fax (609) 935-0102 twx (510) 680-4750
country code 1

plastic two piece backshell

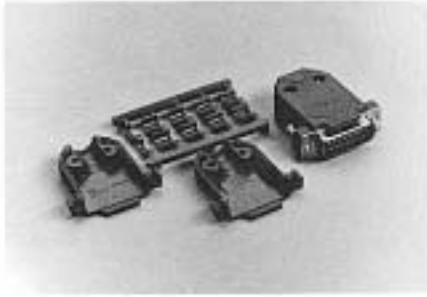

screw lock with
internal cable clamp
- top entry

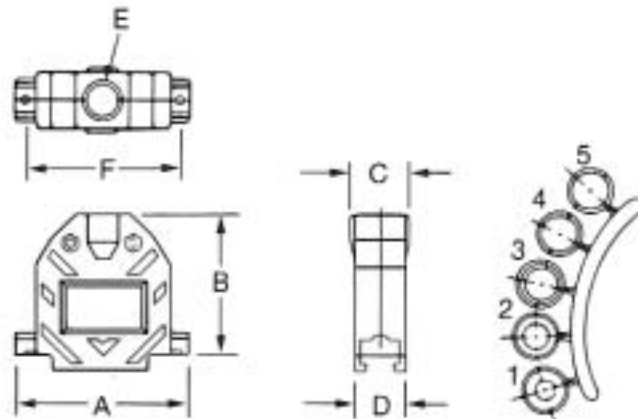

Shell Size	Order No.	A	B	C	D	E	F	Cable Dia. Min/Max
E	17-1724-1	1.225(31.12)	1.397(35.48)	.640(16.26)	.640(16.26)	.400(10.16)	.984(25.00)	.190/.350(4.83/8.89)
A	17-1725-1	1.540(39.12)	1.526(38.76)	.640(16.26)	.640(16.26)	.400(10.16)	1.312(33.32)	.190/.350(4.83/8.89)
B	17-1726-1	2.090(53.09)	1.655(42.04)	.710(18.03)	.640(16.26)	.522(13.26)	1.857(47.17)	.190/.460(4.83/11.68)
C	17-1727-1	2.730(69.34)	1.850(47.00)	.920(23.37)	.640(16.26)	.725(18.42)	2.500(63.50)	.300/.680(7.62/17.27)
D	17-1728-1	2.645(67.18)	1.717(43.61)	.882(22.40)	.750(19.05)	.725(18.42)	2.406(61.11)	.300/.680(7.62/17.27)

metalized plastic two piece backshell

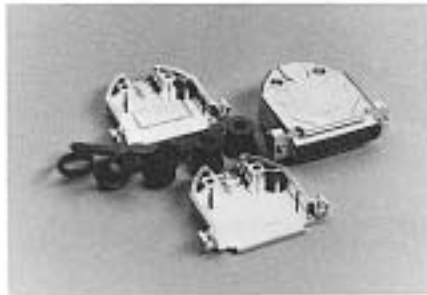

screw lock with
internal cable clamp
- top entry

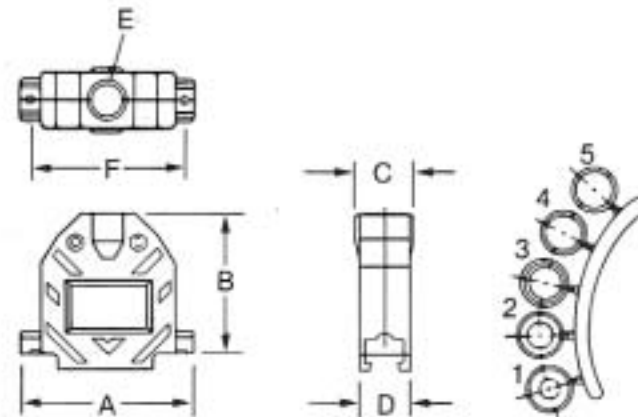

Shell Size	Order No.	A	B	C	D	E	F	Cable Dia. Min/Max
E	17-1724-2	1.225(31.12)	1.397(35.48)	.640(16.26)	.640(16.26)	.400(10.16)	.984(25.00)	.190/.350(4.83/8.89)
A	17-1725-2	1.540(39.12)	1.526(38.76)	.640(16.26)	.640(16.26)	.400(10.16)	1.312(33.32)	.190/.350(4.83/8.89)
B	17-1726-2	2.090(53.09)	1.655(42.04)	.710(18.03)	.640(16.26)	.522(13.26)	1.857(47.17)	.190/.460(4.83/11.68)
C	17-1727-2	2.730(69.34)	1.850(47.00)	.920(23.37)	.640(16.26)	.725(18.42)	2.500(63.50)	.300/.680(7.62/17.27)
D	17-1728-2	2.645(67.18)	1.717(43.61)	.882(22.40)	.750(19.05)	.725(18.42)	2.406(61.11)	.300/.680(7.62/17.27)



spring latch

Material:
Steel clear chromate finish or gold
iridite finish each order no. includes
2 of each style

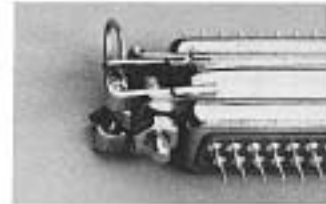
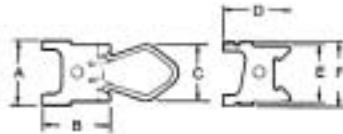

Size	Order No.:		A	B	C	D	E	F
	clear	gold						
E,A,B,C	17-529	17-847	.567(14.4)	.614(15.6)	.484(12.3)	.614(15.6)	.484(12.3)	.567(14.4)
D	17-770	17-850	.681(17.3)	.614(15.6)	.610(15.5)	.614(15.6)	.610(15.5)	.681(17.3)

All dimensions: inches (millimeters)

screw lock assembly - provides positive locking

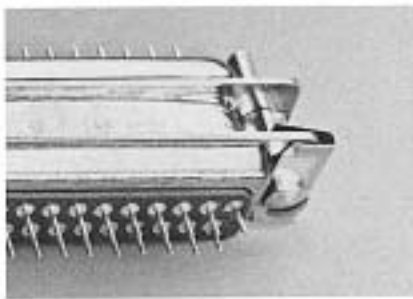

Stainless steel passivated

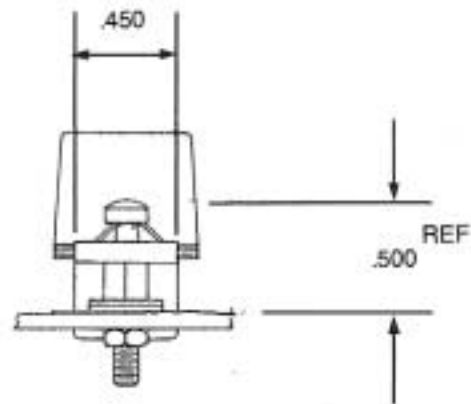

Shell Size	Order No.
E, A, B C & D	17-768

screw type locking assemblies to WPI design

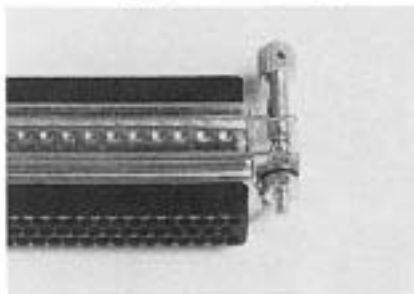

	Clear Chromate Finish
Jack Socket (includes 2 sockets, lock washers & nuts)	17-893
Jack Screw (includes 2 screws, washers & retaining rings)	17-894
Complete Assembly (includes both of above)	17-895

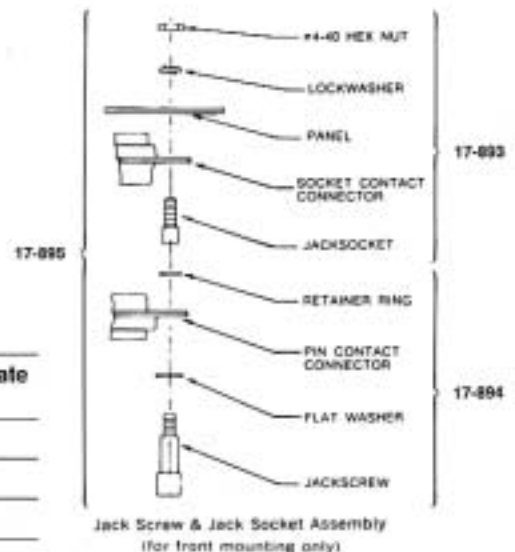

WPI - Salem Division
23 Front Street, Salem, NJ 08079 U.S.A.
phone (609) 935-7601
fax (609) 935-0102 twx (510) 680-4750
country code 1

d-subminiature panel cutouts

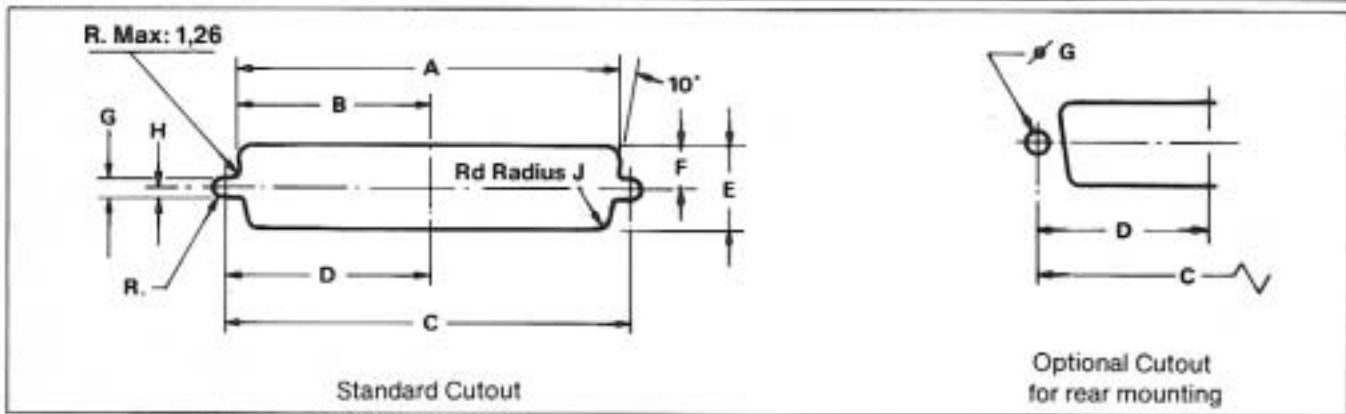
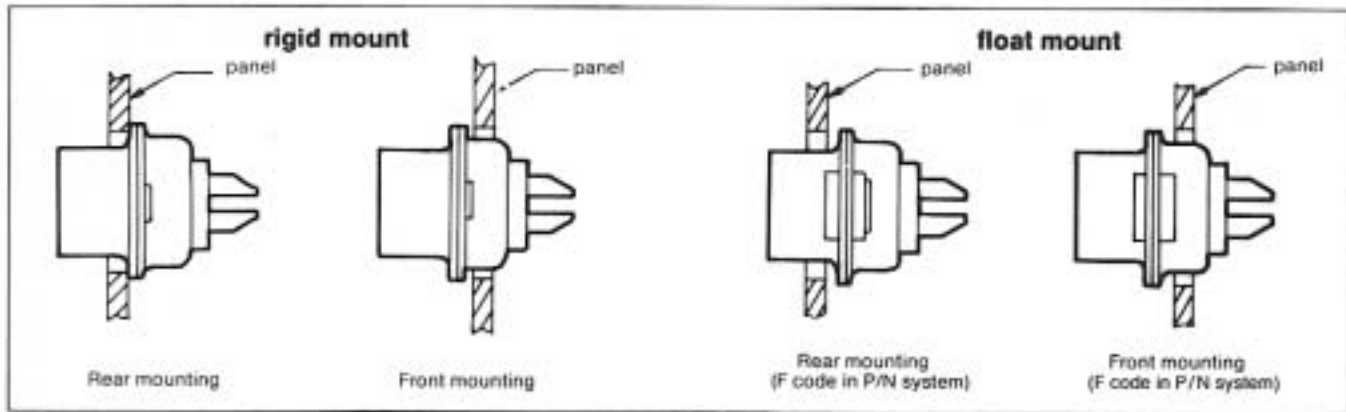

Configuration	Mount type	Mounting Method	A ± .008 (± 0.2)	B ± .008 (± 0.2)	C ± .008 (± 0.2)	D ± .008 (± 0.2)	E ± .008 (± 0.2)	F ± .008 (± 0.2)	G ± .004 (± 0.1)	H ± .004 (± 0.1)	J ± .008 (± 0.2)
9	rigid	Front	.874(22.2)	.437(11.1)	.984(25.0)	.492(12.5)	.512(13.0)	.256(6.5)	.118(3)	.059(1.5)	.083(2.1)
		Rear	.807(20.5)	.402(10.2)	.984(25.0)	.492(12.5)	.449(11.4)	.224(5.7)	.118(3)	.059(1.5)	.134(3.4)
	float	Front	.908(23.0)	.453(11.5)	.984(25.0)	.492(12.5)	.543(13.8)	.272(6.9)	.087(2.2)	.043(1.1)	.083(2.1)
		Rear	.839(21.3)	.417(10.6)	.984(25.0)	.492(12.5)	.441(11.2)	.240(6.1)	.087(2.2)	.043(1.1)	.134(3.4)
15	rigid	Front	1.201(30.5)	.602(15.3)	1.311(33.3)	.657(16.7)	.572(13.0)	.256(6.5)	.118(3)	.059(1.5)	.083(2.1)
		Rear	1.134(28.8)	.567(14.4)	1.311(33.3)	.657(16.7)	.449(11.4)	.224(5.7)	.118(3)	.059(1.5)	.134(3.4)
	float	Front	1.222(31.3)	.610(15.7)	1.311(33.3)	.657(16.7)	.543(13.8)	.272(6.9)	.087(2.2)	.043(1.1)	.083(2.1)
		Rear	1.165(29.6)	.583(14.8)	1.311(33.3)	.657(16.7)	.480(12.2)	.240(6.1)	.087(2.2)	.043(1.1)	.134(3.4)
25	rigid	Front	1.744(44.3)	.870(22.1)	1.850(47)	.925(23.5)	.512(13.0)	.256(6.5)	.118(3)	.059(1.5)	.083(2.1)
		Rear	1.673(42.5)	.839(21.3)	1.850(47)	.925(23.5)	.449(11.4)	.224(5.7)	.118(3)	.059(1.5)	.134(3.4)
	float	Front	1.776(45.1)	.890(22.6)	1.850(47)	.925(23.5)	.543(13.8)	.272(6.9)	.087(2.2)	.043(1.1)	.083(2.1)
		Rear	1.705(43.3)	.854(21.7)	1.850(47)	.925(23.5)	.480(12.2)	.240(6.1)	.087(2.2)	.043(1.1)	.134(3.4)
37	rigid	Front	2.890(60.7)	1.197(30.4)	2.500(63.5)	1.248(31.7)	.512(13.0)	.256(6.5)	.118(3)	.059(1.5)	.083(2.1)
		Rear	2.327(59.1)	1.161(29.5)	2.500(63.5)	1.248(31.7)	.449(11.4)	.224(5.7)	.118(3)	.059(1.5)	.134(3.4)
	float	Front	2.421(61.5)	1.213(30.8)	2.500(63.5)	1.248(31.7)	.543(13.8)	.272(6.9)	.087(2.2)	.043(1.1)	.083(2.1)
		Rear	2.354(59.8)	1.177(29.9)	2.500(63.5)	1.248(31.7)	.480(12.2)	.240(6.1)	.087(2.2)	.043(1.1)	.134(3.4)
50	rigid	Front	2.295(58.3)	1.150(29.2)	2.406(61.1)	1.205(30.6)	.622(15.8)	.311(7.9)	.118(3)	.059(1.5)	.083(2.1)
		Rear	2.217(56.3)	1.110(28.2)	2.406(61.1)	1.205(30.6)	.555(14.1)	.280(7.1)	.118(3)	.059(1.5)	.134(3.4)
	float	Front	2.331(59.2)	1.165(29.6)	2.406(61.1)	1.205(30.6)	.654(16.6)	.327(8.3)	.087(2.2)	.043(1.1)	.083(2.1)
		Rear	2.248(57.1)	1.126(28.6)	2.406(61.1)	1.205(30.6)	.587(14.9)	.295(7.5)	.087(2.2)	.043(1.1)	.134(3.4)

All dimensions: inches (millimeters)

WPI - Salem Division
 23 Front Street, Salem, NJ 08079 U.S.A.
 phone (609) 935-7601
 fax (609) 935-0102 twx (510) 680-4750
 country code 1



d-subminiature panel mounting

A, B, C and H are dimensions between panels and represent the recommended limit to be used in the design of the

connector mounting method. It is recommended that only one assembly either pin or socket, be float mounted.

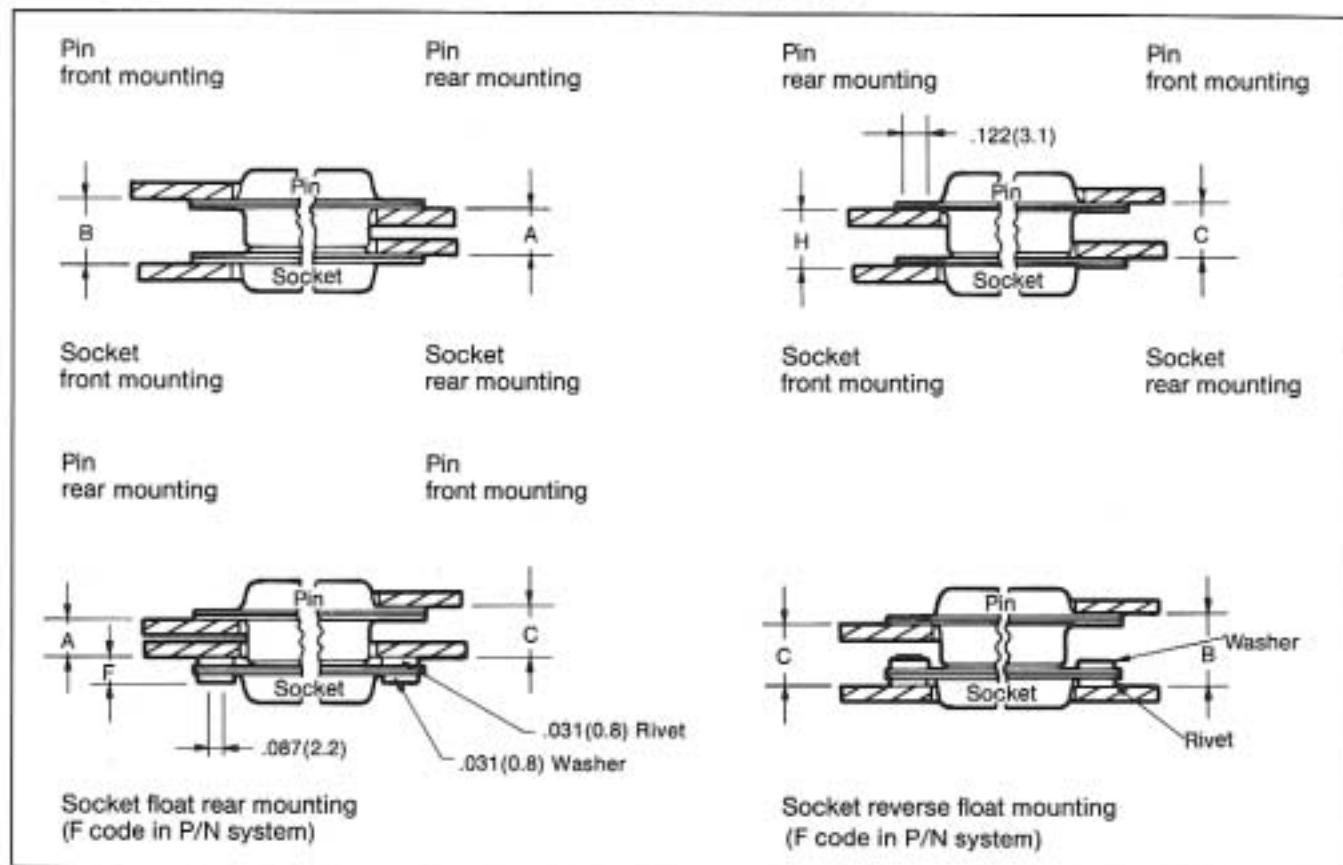

Note:
Plugs have pin contacts.
Receptacles have socket contacts

combination of mated connectors

Size	Pin	Socket	A +.030 0 (+.076) 0	B +.030 0 (+.076) 0	C +.030 0 (+.076) 0	F 0 -.012 0 (-.03)	H +.030 0 (+.076) 0
E,A,B,C,D	Rigid	Rigid	.250(6.35)	.352(8.95)	.301(7.65)	—	.301(7.65)
E,A,B,C,D	Rigid	Float F	.219(5.55)	—	.270(6.85)	.130(3.3)	—
E,A,B,C,D	Float F	Rigid	.219(5.55)	—	.270(6.85)	.130(3.3)	—
E,A,B,C,D	Rigid	Float F	—	.360(9.15)	.321(8.15)	.130(3.3)	—
E,A,B,C,D	Float F	Rigid	—	.360(9.15)	.321(8.15)	.130(3.3)	—

Note: Dimensions are the same if socket or plug connectors are float mounted.



WPI - Salem Division
23 Front Street, Salem, NJ 08079 U.S.A.
phone (609) 935-7601
fax (609) 935-0102 twx (510) 680-4750
country code 1

d-subminiature contact arrangements

printed circuit board cutouts

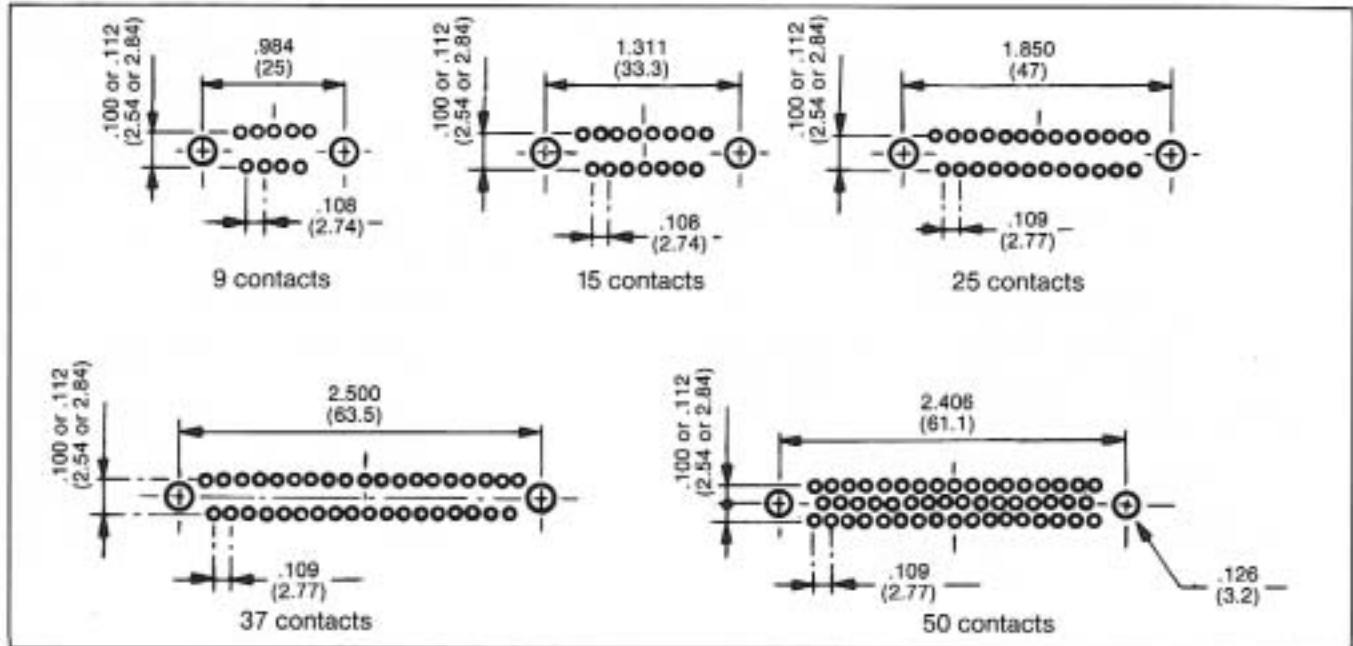

Solder pin diameter	.024(0.6)	.030(0.76)	.040(1.02)
P/C board hole diameter	.030(0.75) min	.035(0.9) min	.047(1.20) min

contact spacing

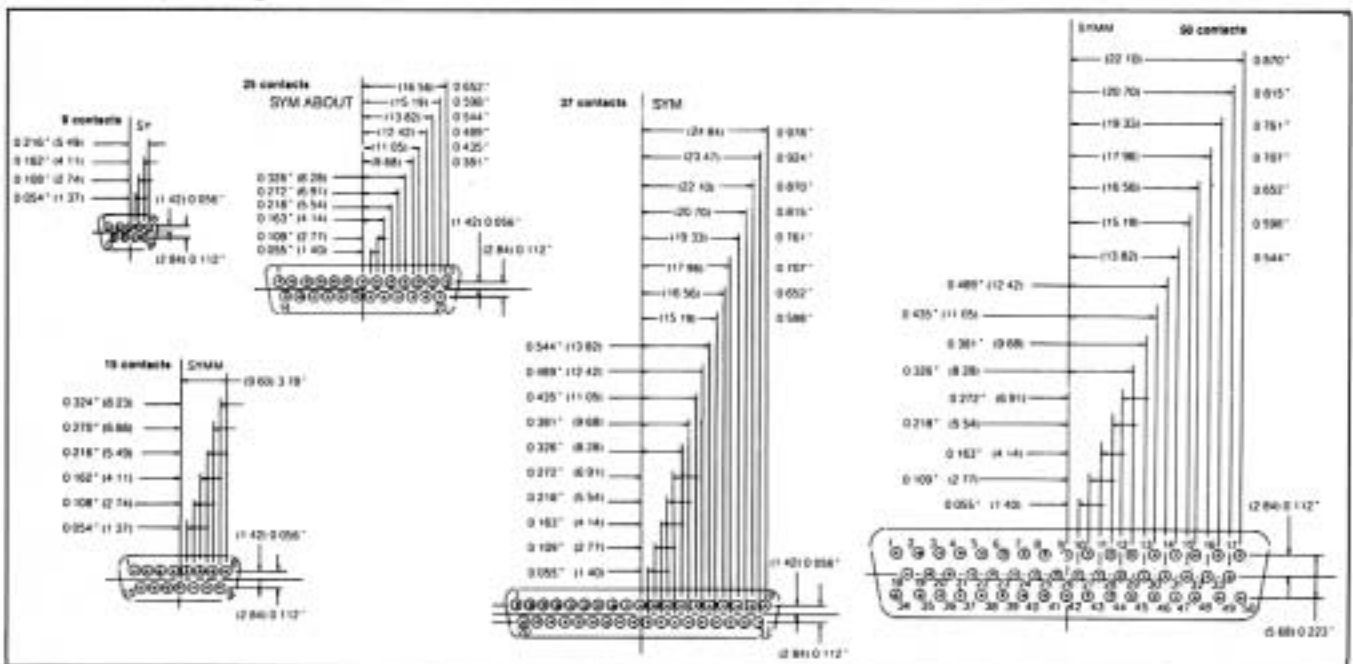

All dimensions: inches (millimeters)

WPI - Salem Division
 23 Front Street, Salem, NJ 08079 U.S.A.
 phone (609) 935-7601
 fax (609) 935-0102 twx (510) 680-4750
 country code 1



WPI® d-subminiature overmold can

...superior EMI shielding & ESD protection

...for use with WPI®
d-subminiature
rear-release connectors
(117 / 177 / 777 series)



dimensions

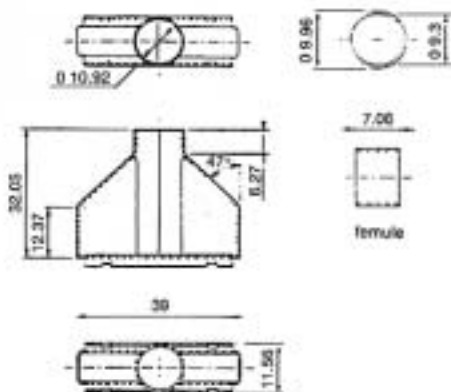

description

This one piece design offers improved shielding characteristics over competitive designs, as well as providing lower installed cost. The WPI® overmold can is available in the popular 25 contact size, and

incorporates a single ferrule for a variety of cable diameters, eliminating the need for inner / outer crimp typical of other offerings. The overmold can offers up to 40 dB shielding at one GHz.

specifications

hood: tin-plated cold rolled steel
ferrule: stainless steel
hood and ferrule plating: bright tin/lead over nickel

backshell: 94v0 thermoplastic.

ordering information

WPI® part number	contents	size
17-1826 (plug)	d-sub overmold can kit*	25
17-1827 (receptacle)	d-sub overmold can kit*	25
* WPI® overmold can kit is comprised of one overmold can with basic ferrule, a rear-release connector, 25 gold flash contacts, a backshell, a grommet, and thumb screws.		
17-9433-25	overmold can with ferrule**	25
** must be used in conjunction with WPI® d-sub connectors		

termination tooling

See Section 16 Page 2 for overmold can termination tools.



WPI - Salem Division
23 Front Street, Salem, NJ 08079 U.S.A.
phone (609) 935-7601
fax (609) 935-0102 twx (510) 680-4750
country code 1

26 series® connectors

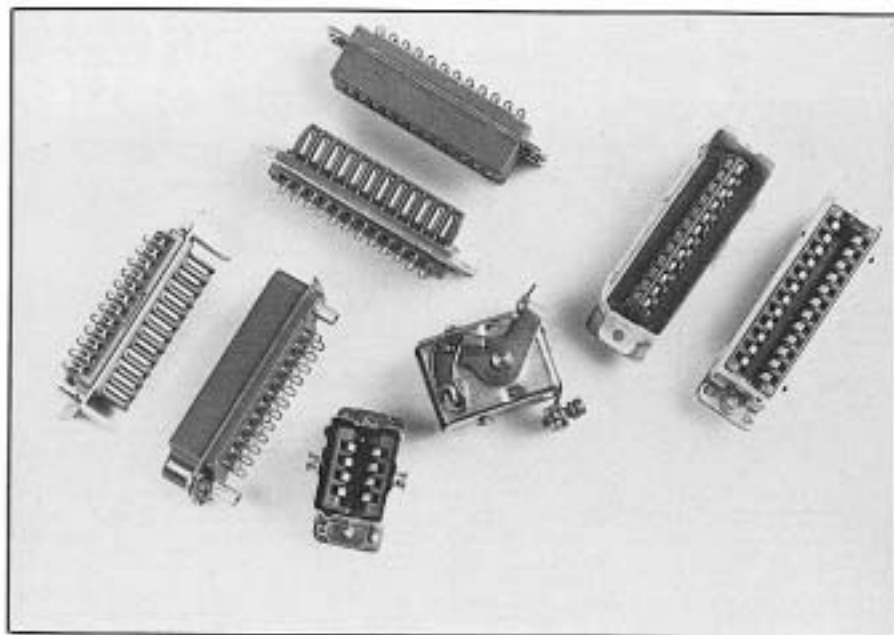

specifications

Current Capacity	5 amps per contact
Voltage Rating	750 volts D.C. at sea level 300 volts D.C. at 60,000 ft.
Operating Temperature	-55°C to +125°C -67°F to +257°F
Contact Plating	.00003" gold over nickel
Maximum Wire Size	16 gauge

Plugs and receptacles are molded of high-impact diallyl phthalate dielectric with molded-in mounting plates of corrosion-resistant passivated stainless steel. Receptacles have float mount bushings which provide .028" radial movement for perfect alignment. Contacts are gold-plated over nickel with solder eyelet tails.

This connector provides rugged, heavy duty interconnections where larger gauge wires must be used and size is not a limiting factor.

Millions of Blue Ribbon Connectors are now used in industrial controls, mobile radios, instruments and test equipment, oscilloscopes, video tape recorders, computer control equipment, TV cameras, data displays, communications equipment, and many other applications requiring high reliability.

features

Contact Mating: The 26 series® connectors mate easily, with no danger of misalignment or bent pins. Two wide, positive pressure contact points produce a self-cleaning and wiping action to keep surfaces clean and clear for low-resistance and continuity.

Longer Life: Estimated service life of 25 years in a mated condition for high reliability.

Versatility: Choose from: 3 rack and panel configurations; 2 cable-to-panel types, 8 to 42 contacts; barrier polarization, pin polarization, barrier polarization with keyed shells, with a large number of alternate positions (available on special order).

Lower Cost: Considering all the superior durability features of design and construction, these connectors offer you lower initial and life-cycle cost over any comparable competitive connector. Immediate off-the-shelf availability from local distributors can be a cost-saving factor also.



26 series® rack-and-panel connectors

pin polarization

For blind mating situations...pins mate before contacts for perfect alignment.

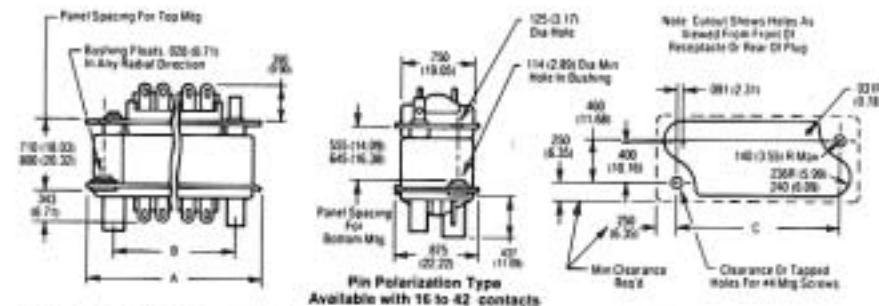

dimensions (plug and receptacle mated)

Contacts	A		B		C	
	in.	mm	in.	mm	in.	mm
16	2.449	(62.20)	1.842	(46.78)	2.024	(51.40)
24	3.125	(79.37)	2.522	(64.05)	2.704	(68.68)
32	3.805	(96.64)	3.202	(81.33)	3.384	(85.95)
42	4.648	(118.05)	4.052	(102.92)	4.234	(107.54)

For reference only, subject to change without notice.

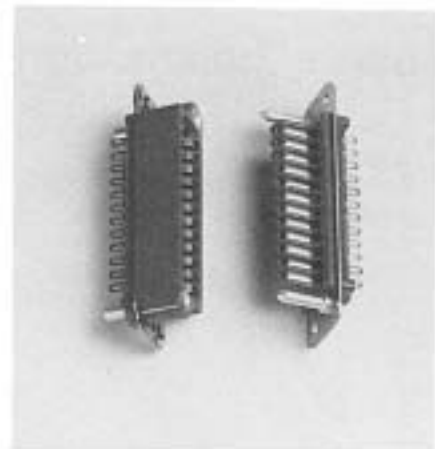

26-190-XX Receptacle 26-159-XX Plug

ordering information

contacts	plug	receptacle
16	26-159-16	26-190-16
24	26-159-24	26-190-24
32	26-159-32	26-190-32
42	26-159-42	26-190-42**

** Not normally stocked by distributors.

barrier polarization

Dielectric barrier prevents mismatching...used in most rack-and-panel or module interconnections.

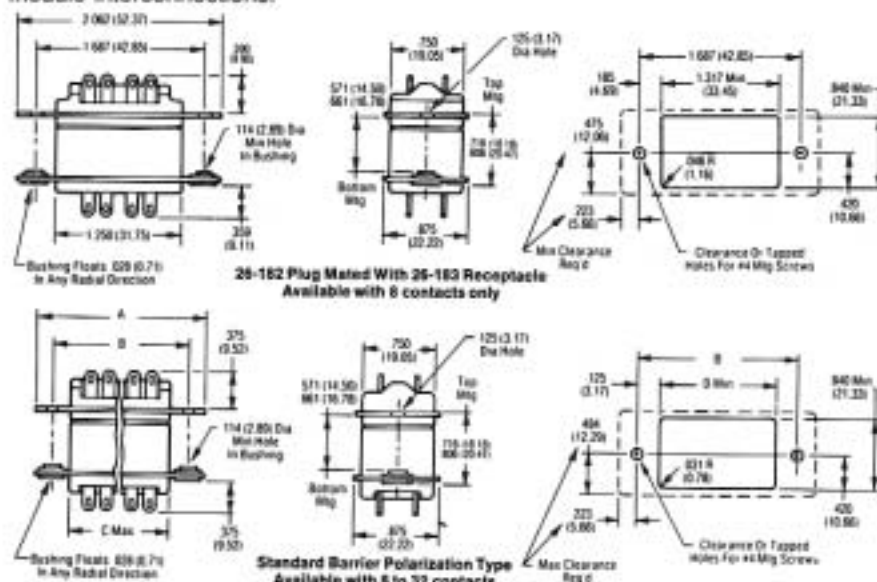

dimensions (plug and receptacle mated)

Contacts	A		B		C Max.		D Min.	
	in.	mm	in.	mm	in.	mm	in.	mm
8	1.726	(43.84)	1.375	(34.92)	1.042	(26.46)	1.120	(28.44)
16	2.475	(62.86)	2.125	(53.97)	1.790	(45.46)	1.868	(47.44)
24	3.225	(81.91)	2.875	(73.02)	2.542	(64.41)	2.620	(66.54)
32	3.975	(100.96)	3.625	(92.07)	3.292	(83.61)	3.370	(85.59)

For reference only, subject to change without notice.

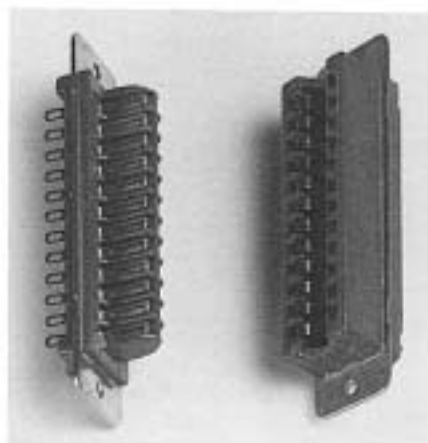

26-4100-XXP Plug 26-4200-XXS Receptacle

ordering information

contacts	plug	receptacle
8	26-182	26-183
8	26-4100-8P	26-4200-8S
16	26-4100-16P	26-4200-16S
24	26-4100-24P	26-4200-24S
32	26-4100-32P	26-4200-32S

26 series® rack-and-panel connectors (cont.)

barrier polarization with keyed shells

Similar to barrier type with addition of aluminum shell on both plug and receptacle. Shell is keyed to prevent accidental mismatching of several connectors mounted on the same panel.

26-41XX connectors have plug (male) insert in receptacle shell. 26-42XX connectors have receptacle (female) inserts in plug shell.

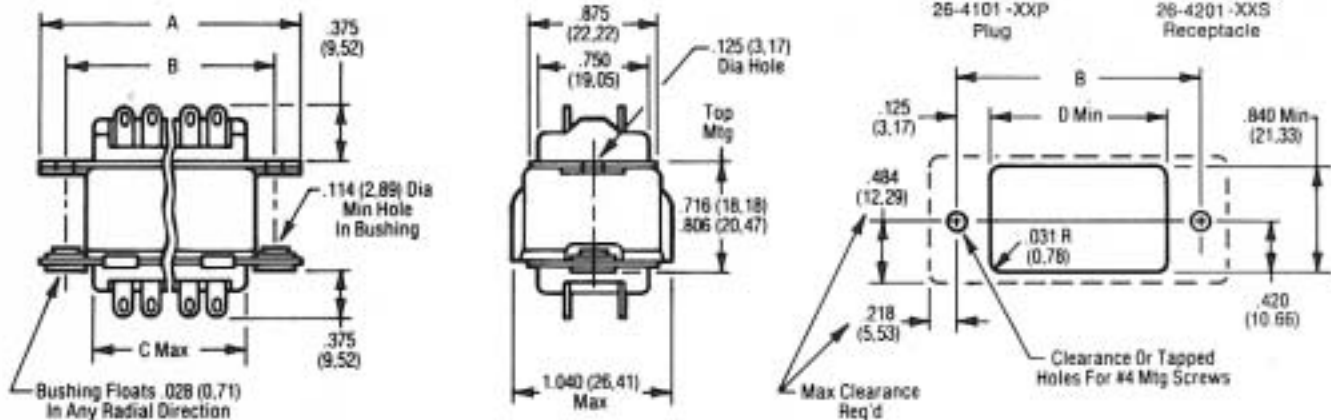
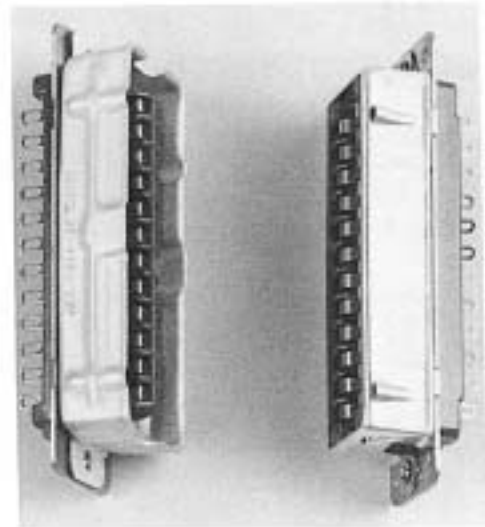

dimensions (plug and receptacle mated)

Contacts	A		B		C Max.		D Min.	
	in.	mm	in.	mm	in.	mm	in.	mm
8	1.726	(43.84)	1.375	(34.92)	1.042	(26.46)	1.120	(28.44)
16	2.475	(62.86)	2.125	(53.97)	1.790	(45.46)	1.868	(47.44)
24	3.225	(81.91)	2.875	(73.02)	2.542	(64.41)	2.620	(66.54)
32	3.975	(100.96)	3.625	(92.07)	3.292	(83.61)	3.370	(85.59)

For reference only, subject to change without notice.

Barrier Polarization Type With Keyed Shells Available with 8 to 32 contacts

ordering information

CONTACTS	PLUGS	RECEPTACLES	SHELL KEYS* NUMBERS	LETTER
8	26-4101-8P	26-4201-8S	1	A
8	26-4102-8P	26-4202-8S	2	A
16	26-4101-16P	26-4201-16S	3-6	A-C
16	26-4102-16P	26-4202-16S	2-5	A-D
24	26-4101-24P	26-4201-24S	3-6	A-C
24	26-4102-24P	26-4202-24S	4-7	A-D
32	26-4101-32P	26-4201-32S	3-6	A-C
32	26-4102-32P	26-4202-32S	4-7	A-D

*Consult factory for available alternate key positions.

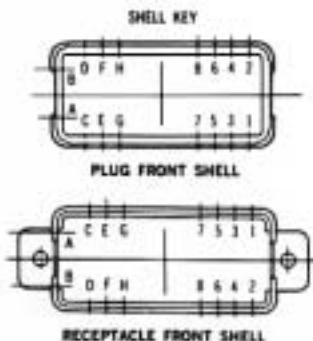

26 series® cable-to-panel connectors

top cable entry

Available in cable-to-panel configurations. This type features positive latching to keep connectors securely mated despite gravity, shock, vibration or tension. Latching arm can also be wire-locked for greater safety. Shells are keyed for polarization and to prevent mismatching of multiple connectors. A wide choice of

key positions is available. Shells can be provided with either plug (male) insert or receptacle (socket) insert as desired. Please specify P for plug or S for socket in part number.

This style provides cable entry at top of nickel-plated brass back shell. Cable opening has strain relief clamp with 2 screws.

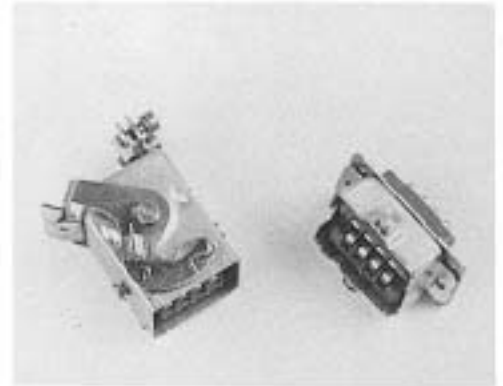

26-4301-XXS or
26-4301-XXP
Plug

26-4401-XXP or
26-4401-XXS
Receptacle

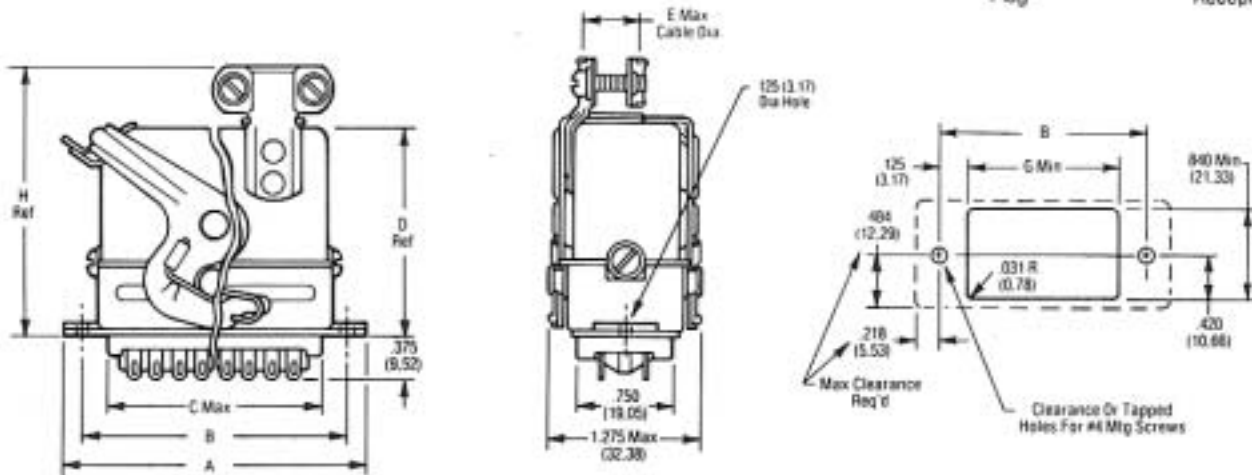

dimensions (plug and receptacle mated)

Contacts	A		B		C Max.		D Ref.		E Max.		G Min.		H Ref.	
	in.	mm	in.	mm	in.	mm	in.	mm	in.	mm	in.	mm	in.	mm
8	1.726	(43.84)	1.375	(34.92)	1.100	(27.94)	1.620	(41.14)	0.312	(7.92)	1.120	(28.44)	2.065	(52.45)
16	2.475	(62.86)	2.125	(53.97)	1.845	(46.86)	1.745	(44.32)	0.625	(15.87)	1.868	(47.44)	2.252	(57.20)
24	3.225	(81.91)	2.875	(73.02)	2.600	(66.04)	1.870	(47.49)	0.625	(15.87)	2.620	(66.54)	2.377	(60.37)
32	3.975	(100.96)	3.625	(92.07)	3.350	(85.09)	1.933	(49.09)	0.625	(15.87)	3.370	(85.59)	2.440	(61.97)

For reference only, subject to change without notice.

Cable-To-Panel—Top Entry Available with 8 to 32 contacts

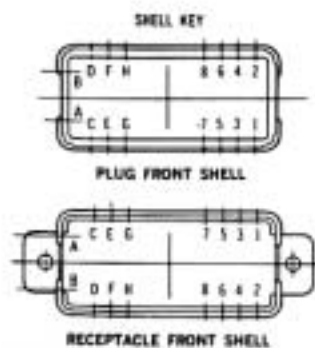

ordering information

CONTACTS	PLUGS	RECEPTACLES	SHELL KEYS* NUMBERS	LETTER
8	26-4301-8P or S	26-4401-8S or P	1	A
8	26-4302-8P or S	26-4402-8S or P	2	A
16	26-4301-16P or S	26-4401-16S or P	3-6	A-C
16	26-4302-16P or S	26-4402-16S or P	2-5	A-D
24	26-4301-24P or S	26-4401-24S or P	3-6	A-C
24	26-4302-24P or S	26-4402-24S or P	4-7	A-D
32	26-4301-32P or S	26-4401-32S or P	3-6	A-C
32	26-4302-32P or S	26-4402-32S or P	4-7	A-D

*Contact factory for alternate key positions.

26 series® cable-to-panel connectors (cont.)

side cable entry

Available in cable-to-panel configurations. This type features positive latching to keep connectors securely mated despite gravity, shock, vibration or tension. Latching arm can also be wire-locked for greater safety. Shells are keyed for polarization and to prevent mismatching of multiple connectors. A wide choice of

key positions is available. Shells can be provided with either plug (male) insert or receptacle (socket) insert as desired. Please specify P for plug or S for socket in part number.

This style provides cable entry at side of nickel-plated brass back shell. Cable opening has strain relief clamp with 2 screws.

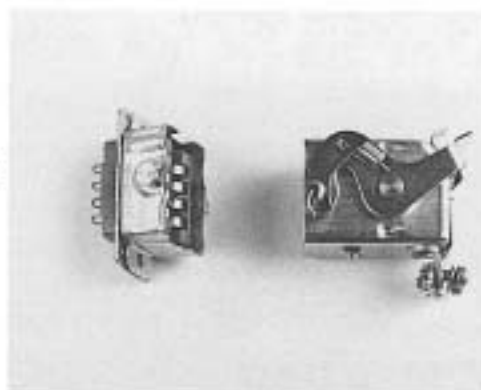

26-4401-XXS
or
26-4401-XXP
Receptacle

26-4501-XXP
or
26-4501-XXS
Plug

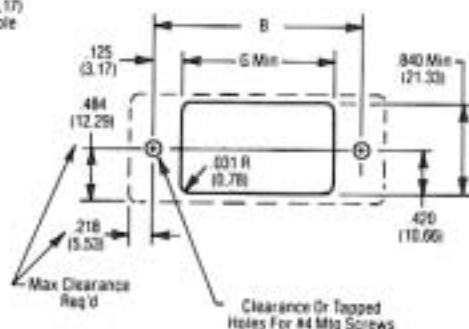
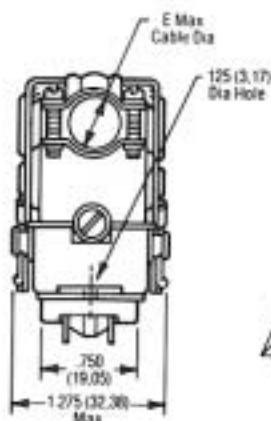
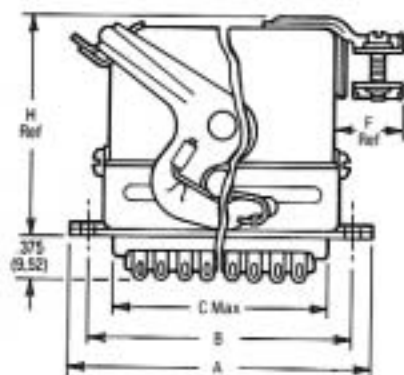

dimensions (plug and receptacle mated)

Contacts	A		B		C Max.		E Max.		F Ref.		G Min.		H Ref.	
	in.	mm	in.	mm	in.	mm	in.	mm	in.	mm	in.	mm	in.	mm
8	1.726	(43.84)	1.375	(34.92)	1.100	(29.74)	0.312	(7.92)	0.438	(11.12)	1.120	(28.44)	1.703	(43.25)
16	2.475	(62.86)	2.125	(53.97)	1.845	(46.86)	0.625	(15.87)	0.500	(12.70)	1.868	(47.44)	1.828	(46.43)
24	3.225	(81.91)	2.875	(73.02)	2.600	(66.04)	0.625	(15.87)	0.500	(12.70)	2.620	(66.54)	1.953	(49.60)
32	3.975	(100.96)	3.625	(92.07)	3.350	(85.09)	0.625	(15.87)	0.500	(12.70)	3.370	(85.59)	2.031	(51.58)

For reference only, subject to change without notice.

Cable-To-Panel—Side Entry Available with 8 to 32 contacts

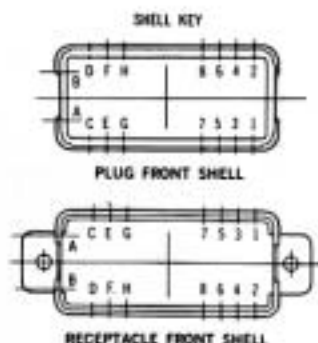

CONTACTS	PLUGS	RECEPTACLES	SHELL KEYS* NUMBERS	LETTER
8	26-4501-8P or S	26-4401-8S or P	1	A
8	26-4502-8P or S	26-4402-8S or P	2	A
16	26-4501-16P or S	26-4401-16S or P	3-6	A-C
16	26-4502-16P or S	26-4402-16S or P	2-5	A-D
24	26-4501-24P or S	26-4401-24S or P	3-6	A-C
24	26-4502-24P or S	26-4402-24S or P	4-7	A-D
32	26-4501-32P or S	26-4401-32S or P	3-6	A-C
32	26-4502-32P or S	26-4402-32S or P	4-7	A-D

*Contact factory for alternate key positions.

WPI - Salem Division
23 Front Street, Salem, NJ 08079 U.S.A.
phone (609) 935-7601
fax (609) 935-0102 twx (510) 680-4750
country code 1



tube/relay sockets

Type S With Retainer Ring Mounting

Black phenolic quick mounting sockets use no screws or rivets. Retainer ring holds socket securely in place. Sockets are notched around circumference for rotation to convenient wiring position.



TYPE S SOCKETS

Contacts	Contacts	WPI Number
4	Brass	78-S4
5	Brass	78-S5
6	Brass	78-S6
8 Octal	Luballoy	78-S8
11	Luballoy	78-S11

Contact factory for P.C. tail version.

DIMENSIONS

Sockets	A	B	C	D	E
78-S4,-S5, -S6	1 1/4	1 1/2	.135	.420	17/32 Approx.
78-S8, -S11	1 1/4	1 1/2	.145	.490	1/4 Approx.

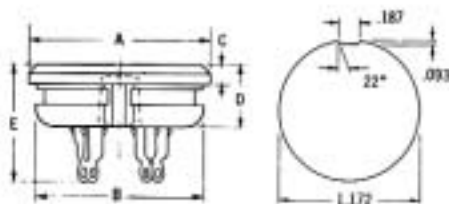

Replacement Type S

Black phenolic type S sockets assembled with retainer ring holding a sturdy nickel-plated steel mounting plate. Mounting plate centers: 1 1/2" (38.1) to 1 55/64" (47.22). Other dimensions same as S type sockets shown above.



REPLACEMENT TYPE S

Contacts	WPI Number
4	78-RS4
8 Octal	78-RS8

Miniature Type S With Retainer Ring Mounting

Sockets are mounted without screws or rivets in 5/8" (15.88) dia. hole. Black phenolic body. Rated 3 amps @ 500 VRMS.



78-S6S
socket and retainer ring



MINIATURE TYPE S

Contacts	Pin Circle Diameter	WPI Number	Mating Plugs	
			Unshielded	Shielded
3	.344	78-S3S	86-71-3S	91-MPM3S
6	.406	78-S6S	86-71-6S	91-MPM6S



WPI - Salem Division
23 Front Street, Salem, NJ 08079 U.S.A.
phone (609) 935-7601
fax (609) 935-0102 twx (510) 680-4750
country code 1

tube/relay sockets continued

Molded-in-plate Type

Steel mounting plate molded directly into solid phenolic body. Two holes in each contact provides easy wiring or connection of components.



77-MIP-8
MIP socket

MIP SOCKETS

Contacts	WPI Number
4	77-MIP-4
8 Octal	77-MIP-8
11	77-MIP-11

Compact MIP Sockets

Octal style socket with phosphor bronze cadmium plated finish contacts. Mounts in 1 1/8" diameter hole, mounting plate holes on 1 5/16" (33,32) centers.



78-88-8
compact MIP socket

COMPACT MIP SOCKET

Contacts	WPI Number
8 Octal	78-88-8

Printed Circuit MIP Socket

Mounts on PC boards up to 1/8" (3.18) thick. Current rating: 3 amps. Contacts are copper alloy (lupalloy) with cadmium plated finish. Contact tails 1/8" (3.18) long, 1/16" (1.57) wide, and .016 (.041) thick. Mount through 1/16" (1.57) diameter hole.



77-MIP6W-0125
PCB MIP socket

PCB MIP SOCKET

No. Contacts	Pin Circle Dia.	WPI Number
8	.687	77-MIP6W-0125
11	.750	77-MIP11W-0125

8 Contact Type With Termination Screws

Phenolic body withstands 300°F continuous without melting or breakdown. Features longer termination screws with captivated pressure plates. 5 amps @ 1,250 VRMS.

- UL recognized (file #E56473)

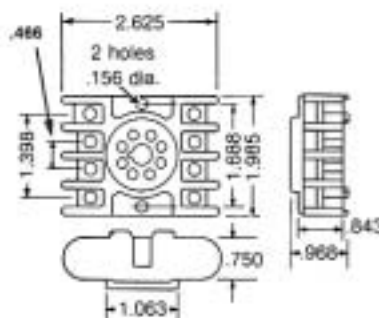

146-103

TERMINATION SCREW TYPE

Description	WPI Number
8 Contact Socket Without Tie Point Inserts — Top Mounted	146-103
Socket with 4 Molded-in Threaded Inserts for Tie Points-Bottom Mounted	146-204



commercial plugs and accessories

CP Type Plugs

Black phenolic plugs for use as chassis connectors, with plug-in units or as cable connectors. 4, 5, and 6 contact plugs do not have center guide post but are polarized for correct insertion by use of two pins of larger diameter than others.



86-CP-8
plug

Miniature Unshielded Type

Black phenolic plugs with molded-in nickel plated brass contacts used extensively for speaker connections. Rated 5 amps @ 500 VRMS. Mounts in 5/8" (15.88) dia. hole.



86-71-3S
plug

Light Duty Connectors

For cable to cable application, mate with each other. For cable to panel applications, mate with type S, RS and MIP tube sockets. Includes metal cap. Available with either pin contacts or socket contacts.



86-PM8-11
plug with cable clamp cap



78-PF8
socket with grommet cap

Caps

Make inexpensive cable connectors of standard sockets, plugs and receptacles. For applications requiring frequent mating and unmating, use 86-3-858 with molded finger grip.



86-3-13
end outlet



86-3-858
strain relief



86-3-24
cable clamp

CP TYPE PLUGS

Contacts	WPI Number
4	86-CP-4
5	86-CP-5
6	86-CP-6
8 Octal	86-CP-8
11	86-CP-11
16	86-CP-16

UNSHIELDED TYPE

Contacts	Pin Circle Diameter	WPI Number	Mating Sockets, Unshielded
3	.343	86-71-3S	78-S3S
6	.400	86-71-6S	78-S6S

CABLE CLAMP CAPS

Contacts	Pin Contacts	Socket Contacts
4	86-PM4-11	78-PF4-11
5	86-PM5-11	78-PF5-11
6	86-PM6-11	78-PF6-11
8	86-PM8-11	78-PF8-11
11	86-PM11-11	78-PF11-11

GROMMET CAPS

Contacts	Pin Contacts	Socket Contacts
4	86-PM4	78-PF4
5	86-PM5	78-PF5
6	86-PM6	78-PF6
8	86-PM8	78-PF8
11	86-PM11	78-PF11

CAPS

Description	WPI Number
End Outlet, 7/16" (11.13) I.D. insulator, Black Epoxy Finish Steel.	86-3-13
Cable Clamp, 1/8" (9.52) wire insulator, Black Epoxy Finish Steel.	86-3-24
Strain Relief Thermoplastic End Outlet 7/16" (7.92) I.D. Black.	86-3-858



WPI - Salem Division
23 Front Street, Salem, NJ 08079 U.S.A.
phone (609) 935-7601
fax (609) 935-0102 twx (510) 680-4750
country code 1

microphone connectors

91-Q series— audio connector

WPI now introduces the 91-Q Series connectors that effectively meet the rugged challenges of contemporary, sophisticated consumer and industrial electronics in a grounded-version connector.

versatile

91-Q Series connectors can be used in a wide range of applications:

audio equipment—Microphones, amplifiers, pre-amps, mixers, speakers, record players, tape decks, recorders, inter-coms, 2-way radio equipment, broadcast studio equipment, sound movie projectors, film strip projectors, video recorder systems, patch cords, etc.

test instruments—Analyzers, bridges, comparators, decade boxes, gauges and indicators, meters, standards, test probes, medical electronic instruments, x-ray equipment, scientific recording, measuring devices, etc.

great performance electrical—

No. of Contacts	Test	Voltage Rms Rating	Current Rating	Wire Size AWG
3	1400	133	15A	12
4	1400	133	10A	16
5	1400	133	7.5A	18

temperature rating—20°F to 160°F, (-30°C to 71°C).

dielectric withstanding voltage—1400 V at 60Hz for one minute between any two contacts or between any contact and connector shell.

durability—Withstands 500 coupling cycles without any detrimental mechanical or electrical breakdowns.

insulation resistance—Exceeds 100 megohms.

contact resistance—Voltage drop is between 45-55 mV at rated current dependent upon contact and wire size.



corrosion resistance—Withstands standard MIL-STD-202 48-hour salt spray test without damage or corrosion.

control systems—Counters, detectors, alarms, transducers, servos, electric eyes, gauges, indicators, timers, regulators, etc.

and others—Computer peripheral equipment, educational equipment, entertainment systems, etc.

application engineered rugged—Solid die cast construction provides tough, high impact strength to withstand rugged use without the risk of failure from breakage.

attractive—Satin nickel plating enhances the appeal of even the most sophisticated equipment. . . non-reflective finish is ideally suited for studio use. Also available in lustrous black chrome.

compact—Reduced shell length for minimum weight and bulk for easier handling.

fully intermateable and interchangeable . . . with all present industry standard latch-lock type audio connectors.

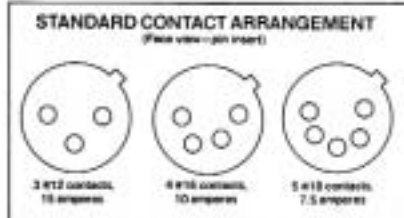

quick, easy assembly/disassembly—Unique set screw cable strain relief feature effectively grips wide range of cable diameters. Utilized inserts all combine to provide greater savings in connector assembly and termination.

quality construction shells and latchlock—Durable zinc die-cast with protective satin nickel plate.

insert dielectric—High strength reinforced thermoplastic.

contacts—Copper alloy with silver plating. Pins and sockets with solder cup termination are fixed in position for quick termination.

cable clamp—Internal set screw cable clamp and Noryl® nut accept commonly used $\frac{3}{16}$ " to $\frac{1}{4}$ " diameter cables.

Noryl® is a registered trademark of General Electric Co.

WPI - Salem Division
23 Front Street, Salem, NJ 08079 U.S.A.
phone (609) 935-7601
fax (609) 935-0102 twx (510) 680-4750
country code 1



91-Q series— audio connector

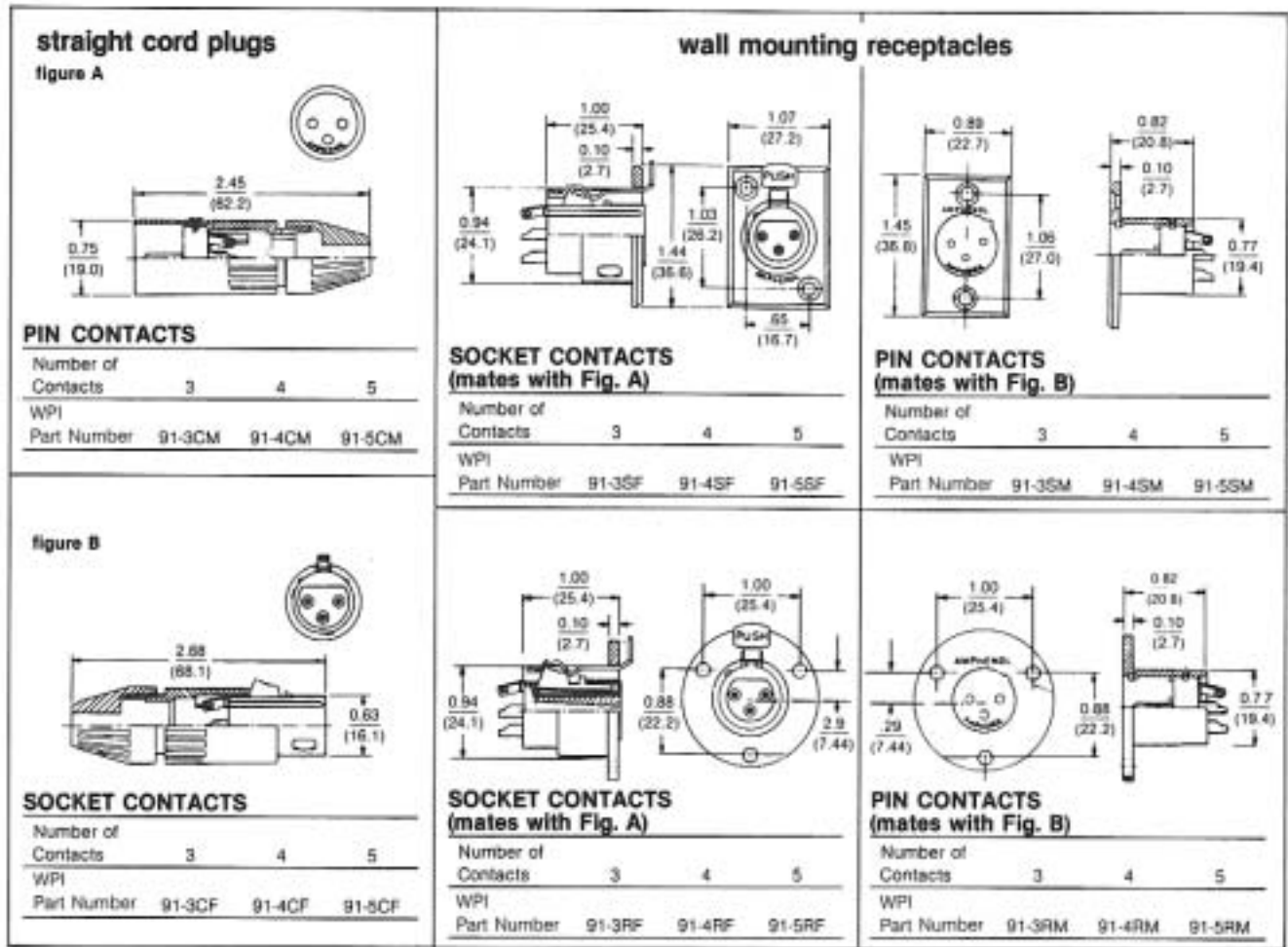

FULLY INTERCHANGEABLE WITH ALL LATCHLOCK AUDIO CONNECTORS

Select the right WPI connector from this cross reference guide.

All connectors shown are considered electrically equivalent and mechanically interchangeable.

WPI Part Number	Replaces Old Amphenol Number	Switchcraft	Cannon	Number of Contacts	Description Connector Type
91-3CF	91-454,91-854	A3F	XLR-3-11C	3 female	Cable Plug
91-3CM	91-453,91-853	A3M	XLR-3-12C	3 male	Cable Plug
91-3SF	91-458	D3F	XLR-3-31	3 female	Square Flange Receptacle
91-3SM	91-455	D3M	XLR-3-32	3 male	Square Flange Receptacle
91-3RF	91-856	C3F	XLR-3-13	3 female	Round Flange Receptacle
91-3RM	91-855	C3M	XLR-3-14	3 male	Round Flange Receptacle
91-4CF	91-458,91-858	A4F	XLR-4-11C	4 female	Cable Plug
91-4CM	91-457,91-857	A4M	XLR-4-12C	4 male	Cable Plug
91-4SF	91-460	D4F	XLR-4-31	4 female	Square Flange Receptacle
91-4SM	91-459	D4M	XLR-4-32	4 male	Square Flange Receptacle
91-4RF	91-860	C4F	XLR-4-13	4 female	Round Flange Receptacle
91-4RM	91-859	C4M	XLR-4-14	4 male	Round Flange Receptacle
91-5CF	91-462	A5F	XLR-5-11C	5 female	Cable Plug
91-5CM	91-461	A5M	XLR-5-12C	5 male	Cable Plug
91-5SF	91-464	D5F	XLR-5-31	5 female	Square Flange Receptacle
91-5SM	91-463	D5M	XLR-5-32	5 male	Square Flange Receptacle
91-5RF	—	C5F	XLR-5-13	5 female	Round Flange Receptacle
91-5RM	—	C5M	XLR-5-14	5 male	Round Flange Receptacle

NOTE: For black chrome finish add (436) to end of part number when ordering.



WPI - Salem Division
23 Front Street, Salem, NJ 08079 U.S.A.
phone (609) 935-7601
fax (609) 935-0102 twx (510) 680-4750
country code 1

microphone connectors

3, 4 or 6 Contacts

The connectors are designed primarily for audio equipment but are used extensively on all types of portable equipment.

Connectors feature positive screw-type coupling ring connection and squeeze type clamp cable grips.

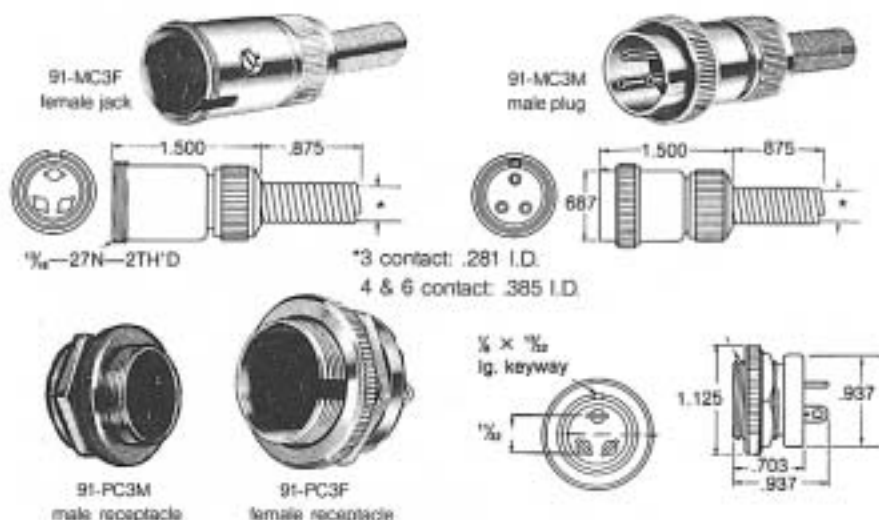

SPECIFICATIONS

Shells	Chrome plated brass
Dielectric	molded black phenolic
Voltage rating	600 V (RMS)
Current rating	female contacts - 3 amps male contacts - 5 amps
Voltage breakdown (RMS) between terminal and ground	2000 V
Cord protector spring	3 contact - .281" (7.14) I.D. 4-6 contact - .385" (9.78) I.D.
Receptacle mounting hole	7/32" (21.44) up to 1/4" (3.18) thick

THREADED COUPLING - 3, 4, or 6 CONTACTS

No. Contacts	Description	WPI Number	Mates With WPI Number
3	Female Cable Jack	91-MC3F	91-MC3M
3	Female Cable Plug	91-MC3F1	91-MC3M1,91-PC3M
3	Male Cable Plug	91-MC3M	91-MC3F,91-PC3F
3	Male Cable Jack	91-MC3M1	91-MC3F1
3	Female Panel Receptacle	91-PC3F	91-MC3M
3	Male Panel Receptacle	91-PC3M	91-MC3F1
4	Female Cable Jack	91-MC4F	91-MC4M
4	Female Cable Plug	91-MC4F1	91-MC4M1,91-PC4M
4	Male Cable Plug	91-MC4M	91-MC4F,91-PC4F
4	Contact #1 in Line with Key	91-MC4M-12	-
4	Male Cable Jack	91-MC4M1	91-MC4F1
4	Female Panel Receptacle	91-PC4F	91-MC4M
4	Contact #1 in Line with Key	91-PC4F-12	-
4	Male Panel Receptacle	91-PC4M	91-MC4F1
6	Female Cable Jack	91-MC6F	91-MC6M
6	Female Cable Plug	91-MC6F1	91-PC6M
6	Male Cable Plug	91-MC6M	91-MC6F,91-PC6F
6	Female Panel Receptacle	91-PC6F	91-MC6M
6	Male Panel Receptacle	91-PC6M	91-MC6F1
-	Cap & Chain for Receptacle	91-CCC3	-
-	Female Insert	91-3F	-
-	Male Insert	91-3M	-

Single Contact

Standard type. Chrome plated machined brass with threaded coupling. Receptacles mount in .385" (9.78) holes when grounded; .500" (12.70) holes for ungrounded two circuit operation. Spring cord protection for 1/4" (6.35) cable.



SINGLE CONTACT

Description	WPI Number
Straight Plug	80-75-MC1F
Cable Jack	80-75-MC1M
Cap & Chain	80-75-CCC1

WPI - Salem Division
23 Front Street, Salem, NJ 08079 U.S.A.
phone (609) 935-7601
fax (609) 935-0102 twx (510) 680-4750
country code 1



microphone connectors continued

Single and Double Contact

Chrome plated machined brass shells with threaded coupling and black phenolic dielectric. For shielded cables, single and two conductor cables, etc. Mounting hole $\frac{5}{16}$ " (15.88). Maximum chassis thickness for lock nut type receptacle: $1\frac{11}{32}$ " (8.74). Cable dia: up to $\frac{5}{16}$ " (7.92).

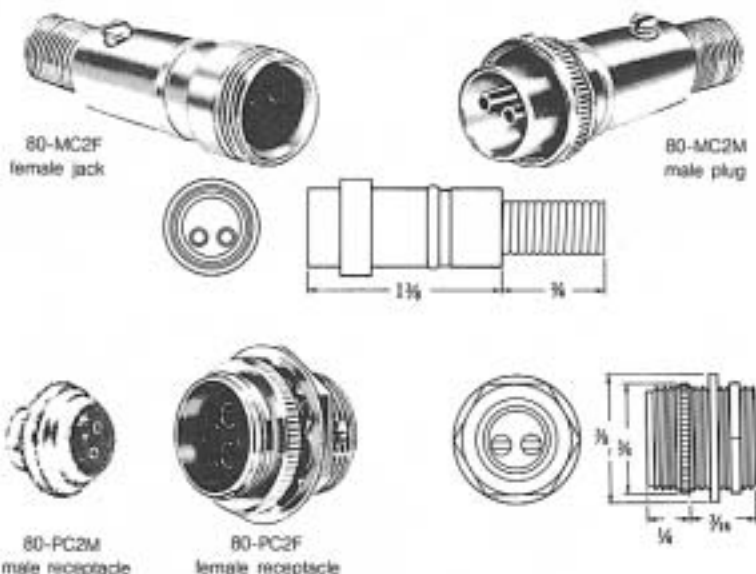

SPECIFICATIONS

Voltage/current rating - single contact:	Male - 1250 V, 5 amps Female - 1000 V, 3 amps
Double contact:	Male - 600 V, 3 amps Female - 600 V, 3 amps
Voltage breakdown between terminals and ground	Single contact male - 4000 V Female - 3000 V Double contact male - 2000 V Female - 2000 V

THREADED COUPLING - 1 or 2 CONTACTS

Contacts	Description	WPI Number	Mates With
1	Male Cable Plug	80-M	80-C
1	Female Panel Receptacle	80-C	80-M
2	Male Cable Plug	80-MC2M	80-MC2F or 80-PC2F
2	Female Cable Plug	80-MC2F1	80-PC2M or 80-MC2M1
2	Female Cable Jack	80-MC2F	80-MC2M
2	Male Cable Jack	80-MC2M1	80-MC2F1
2	Female Panel Receptacle	80-PC2F	80-MC2M
2	Male Panel Receptacle	80-PC2M	80-MC2F1
-	Female Insert	80-2F	-
-	Male Insert	80-2M	-
-	Cap & Chain for Receptacle	80-75-CCC1	-

Miniature Connectors

Compact connectors for shielded or unshielded cables. Can be used for battery antenna or microphone applications

SPECIFICATIONS

Shells	Cadmium plated brass
Dielectric	Black phenolic
Cable diameter	up to $\frac{1}{4}$ " (6.35)
Voltage rating	500 V, 3 amps



CABLE SOCKETS

No. Contacts	Sockets $\frac{11}{16}$ " Long Shell	Mating Plugs $\frac{11}{16}$ " Long Shell
3	91-MPF3S	91-MPM3S
4	91-MPF4S	91-MPM4S
5	91-MPF5S	91-MPM5S
6	91-MPF6S	91-MPM6S

CABLE PLUGS

No. Contacts	Plugs $\frac{11}{16}$ " Long Shell	Mating Socket	
		Cable Socket $\frac{11}{16}$ " Shell	Chassis Unshielded
3	91-MPM3S	91-MPF3S	78-S3S
4	91-MPM4S	91-MPF4S	-
5	91-MPM5S	91-MPF5S	-
6	91-MPM6S	91-MPF6S	78-S6S



WPI - Salem Division
23 Front Street, Salem, NJ 08079 U.S.A.
phone (609) 935-7601
fax (609) 935-0102 twx (510) 680-4750
country code 1

126 series miniature hexagonal connectors

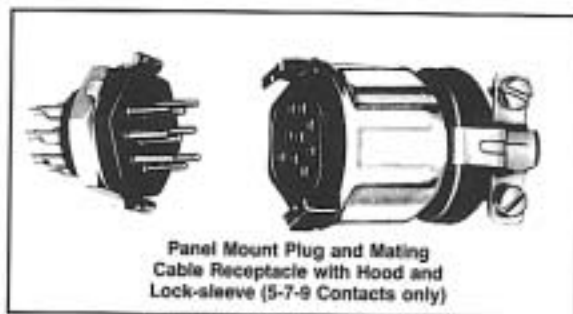
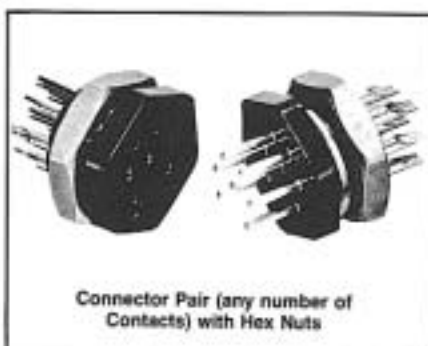

WPI miniature hexagonal connectors are available in four contact configurations with a variety of accessories to meet a wide range of applications.

The connectors can be used for rack and panel, cable to cable, and cable to panel connections.

Locking clips are available to prevent unmating caused by vibration or shock.

Dimensions

Overall Diameter – $\frac{3}{4}$ "

Mated – $1\frac{15}{64}$ " (extended length to the back of the cable clamp)

Specifications

Dielectric — thermoplastic

Contact size — #20 (except one #16 on 4 contact insert)

Wire size — #20 or smaller

Temperature range — -60°C to $+125^{\circ}\text{C}$
(-76°F to $+257^{\circ}\text{F}$)

Current rating — 7.5 amps

Voltage rating — 500 VAC (RMS) at Sea Level

Hardware — cold rolled steel, nickel plated

Contacts — copper alloy, gold over nickel plate

Panel thickness — $\frac{3}{32}$ " (max)

Mounting Holes

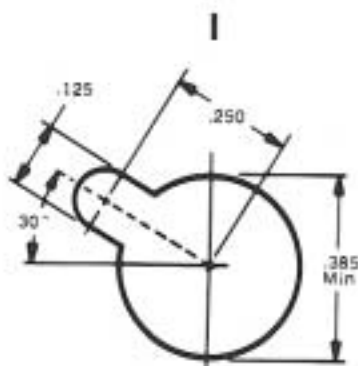

Four-Contact
126-214, 126-214-1001,
126-233, 126-215-1002 only



5-7-9 Contact
Hex Nut Type Without
Panel Locking Clip

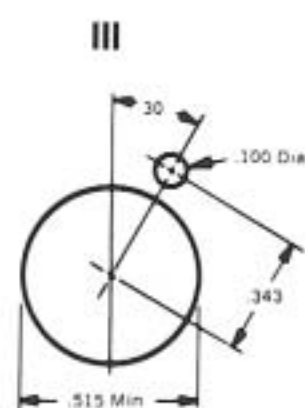

5-7-9 Contact
Hex Nut Type With
Panel Locking Clip

Design specifications subject to change. Consult WPI for the latest specifications.

WPI - Salem Division
23 Front Street, Salem, NJ 08079 U.S.A.
phone (609) 935-7601
fax (609) 935-0102 twx (510) 680-4750
country code 1



126 series connector assemblies

4-Contact

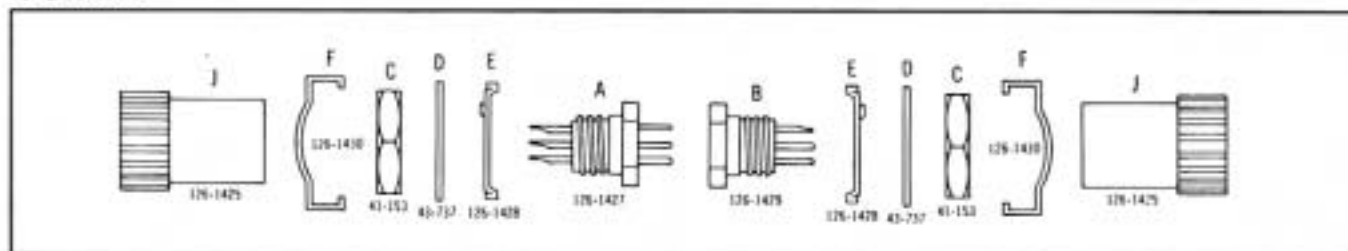

5-7-9 Contact Connectors

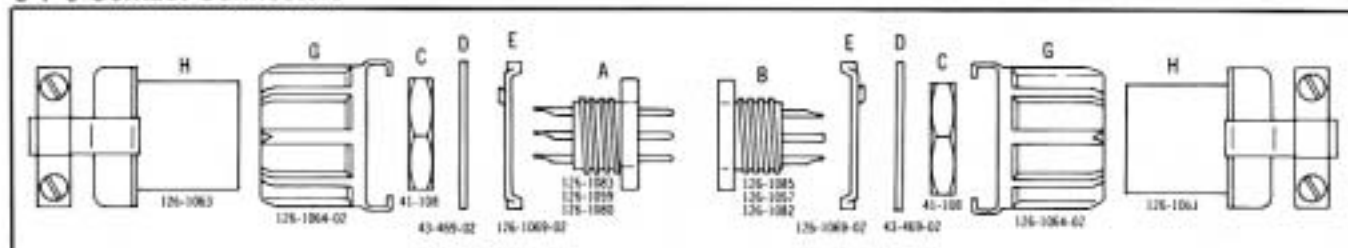

order information

These connectors can be ordered in any combination to suit your needs. Please refer to the exploded view drawing above to determine the components you require. Note the identification letter. Then order by the WPI part

number indicated along side the desired combination of components and the required number of contacts. For example, a male 5 contact connector with rear hood & cable clamp and lock sleeve requires components A, G and H. In the column for male 5 contact

assemblies, AGH indicates part number 126-217. If you order part #126-217, you will automatically receive all three components. They may also be ordered individually, if you prefer. Simply refer to the individual component part numbers shown below.

connector assemblies

4-Contact

Key	MALE Part No.	Mtg.	Key	FEMALE Part No.	Mtg.
A	126-1427	—	B	126-1429	—
AC	126-1431 *	—	BC	126-3815 *	—
ACD	126-1432 *	—	BCD	126-3816 *	—
AFJ	126-214-1000	—	BFJ	126-215	—
ACE	126-214	I	BCE	126-233	I
ACDE	126-214-1001 *	I	BCDE	126-215-1002 *	I
AEJ	126-214-1002 *	—	BEJ	126-215-1001 *	—

Backshells do not have cable clamps.

5-Contact

Key	MALE Part No.	Mtg.	Key	FEMALE Part No.	Mtg.
A	126-1083	—	B	126-1085	—
AC	126-010	II	BC	126-011	II
ACD	126-010-1000 *	II	BCD	126-011-1000 *	II
AGH	126-217	—	BGH	126-223	—
ACE	126-216	III	BCE	126-218	III
ACDE	126-216-1000 *	III	BCDE	126-218-1000 *	III
AEH	126-217-1000 *	—	BEH	126-223-1000 *	—

*Non-stocking item — Consult factory for delivery.



WPI - Salem Division
23 Front Street, Salem, NJ 08079 U.S.A.
phone (609) 935-7601
fax (609) 935-0102 twx (510) 680-4750
country code 1

126 series connector assemblies (cont.)

parts

4-Contact Connector

Description	Part No.	Item Key
Basic Male Connector	126-1427	A
Basic Female Connector	126-1429	B
Hex Nut	41-153	C
Lockwasher	43-737	D
Clip #1	126-1428	E
Clip #2	126-1430	F
Hood	126-1425	J

7-Contact

Key	MALE Part No.	Mtg.	Key	FEMALE Part No.	Mtg.
A	126-1059	—	B	126-1057	—
AC	126-191	II	BC	126-192	II
ACD	126-191-1000 *	II	BCD	126-192-1001 *	II
AGH	126-195	—	BGH	126-196	—
ACE	126-197	III	BCE	126-198	III
ACDE	126-197-1000 *	III	BCDE	126-198-1003 *	III
AEH	126-195-1002 *	—	BEH	126-196-1000 *	—

9-Contact

Key	MALE Part No.	Mtg.	Key	FEMALE Part No.	Mtg.
A	126-1080	—	B	126-1082	—
AC	126-012	II	BC	126-013	II
ACD	126-012-1000 *	II	BCD	126-013-1000 *	II
AGH	126-220	—	BGH	126-222	—
ACE	126-219	III	BCE	126-221	III
ACDE	126-219-1000 *	III	BCDE	126-221-1000 *	III
AEH	126-220-1000 *	—	BEH	126-221-1001 *	—

5-7-9-Contact Connectors

Description	Part No.	Item Key
5-contact Basic Male Connector	126-1083	A
5-contact Basic Female Connector	126-1085	B
7-contact Basic Male Connector	126-1059	A
7-contact Basic Female Connector	126-1057	B
9-contact Basic Male Connector	126-1080	A
9-contact Basic Female Connector	126-1082	B
Hex Nut	41-108	C
Lock washer	43-469-02	D
Clip	126-1069-02	E
Locksleeve	126-1064-02	G
Hood & Cable Clamp	126-1063	H

*Non-stocking item — Consult factory for delivery.

WPI - Salem Division
23 Front Street, Salem, NJ 08079 U.S.A.
phone (609) 935-7601
fax (609) 935-0102 twx (510) 680-4750
country code 1



133/143 series commercial and industrial printed circuit connectors

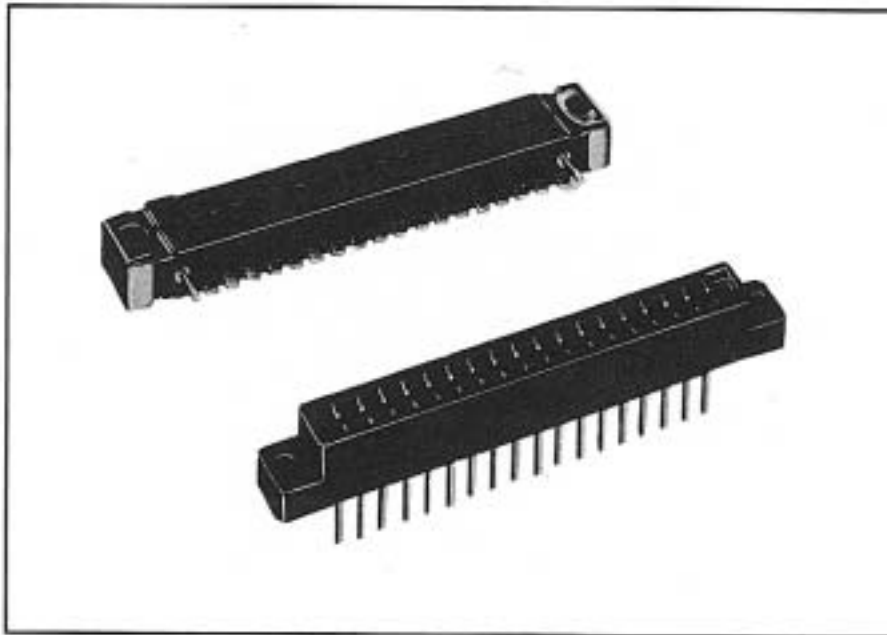

specifications

operating voltage: 600 VAC (RMS) at sea level

current rating: 5 amps

dielectric material: industrial type blue-mineral-filled diallyl phthalate per MIL-M-14 Type MDG.

dielectric resistance: 5000 megohms min.

contact material: 133 series-brass, 143 series-phosphor bronze and copper alloy.

contact plating: standard .000020 (0.000508) min. gold over nickel

contact resistance: 25 millivolts at rated current

board thickness: 133 series - male plug adapters for pc boards, especially useful in situations involving other than normal 1/16 (1,57) thick boards 143 series - .054 (1,37 to .070 (1,78) pc board or 133 series plugs

guide pin material: zinc plated brass
end cap material: stainless steel (passivated)

133 series dimensions

No. of Contact Positions	A Max.	B Ref.	C Ref.
6	1.852 (47.04)	1.531 (38.89)	0.781 (19.84)
10	2.477 (62.92)	2.156 (54.76)	1.406 (35.91)
12	2.790 (70.87)	2.468 (62.69)	1.718 (43.64)
15	3.257 (82.73)	2.937 (74.60)	2.187 (55.55)
18	3.727 (94.67)	3.406 (86.51)	2.656 (67.46)
22	4.362 (110.54)	4.031 (102.39)	3.281 (83.38)

133 series

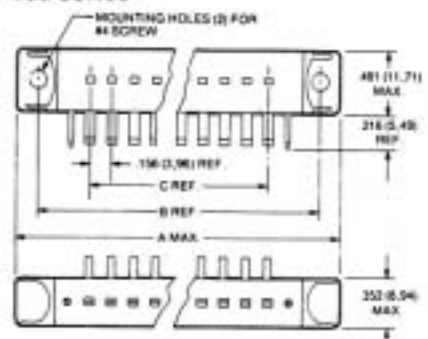

ALL DIMENSIONS REFERENCE ONLY



WPI - Salem Division
 23 Front Street, Salem, NJ 08079 U.S.A.
 phone (609) 935-7601
 fax (609) 935-0102 twx (510) 680-4750
 country code 1

133/143 series commercial and industrial printed circuit connectors (cont.)

.156" (3.96) contact centers

order information

To order the 133/143 series connector required, put the part number together as per the following example:

1 3 3 - 0 1 5 - 2 1 - (1 0 1)

SERIES NUMBER
133 Plug
143 Receptacle

NUMBER OF CONTACT POSITIONS

Digit Group	No. of Contacts
006-	6
010-	10
012-	12
015-	15
018-	18
022-	22
026-	28
036-	36

The 28 and 36 position connectors are available only in the 143 Series.

USER INFORMATION

POLARIZING KEY LOCATION (on 143 Series)

A 1001-	P 1013-	c 1025-
B 1002-	R 1014-	d 1026-
C 1003-	S 1015-	e 1027-
D 1004-	T 1016-	f 1028-
E 1005-	U 1017-	g 1029-
F 1006-	V 1018-	h 1030-
H 1007-	W 1019-	j 1031-
J 1008-	X 1020-	k 1032-
K 1009-	Y 1021-	m 1033-
L 1010-	Z 1022-	n 1034-
M 1011-	a 1023-	p 1035-
N 1012-	b 1024-	r 1036-

COMMON DEVIATIONS

- (101) .0001 (0.00254) min. gold-over nickel contact plating
- (102) .00003 (0.00086) gold-over-nickel contact plating
- (107) (for receptacle) stainless-steel float bushings
- + (110) (for receptacle) card guide, 15, 18 & 22 size only

tail style 133 series



143 series

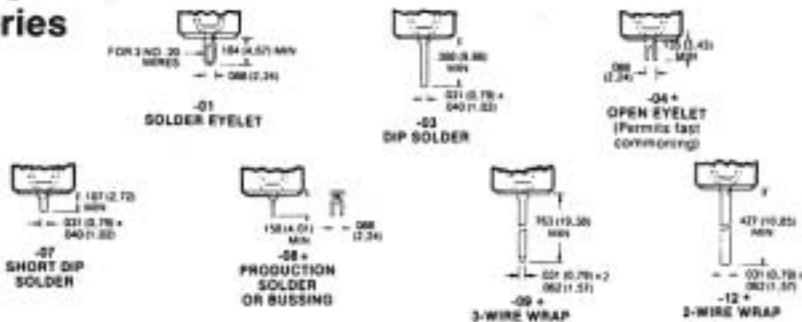

polarization



143-953
Over-the-Contact
Metal Key



143-754
Between the Contact
Plastic Key
(available for 15, 18, 22 or 26 sizes.)

*Non-stocking item — Consult factory for delivery.

WPI - Salem Division
23 Front Street, Salem, NJ 08079 U.S.A.
phone (609) 935-7601
fax (609) 935-0102 twx (510) 680-4750
country code 1



133/143 series commercial and industrial printed circuit connectors (cont.)

143 series dimensions

No. of Contacts Positions	A Max.	B Ref.	C Max.	D Min.	E Ref.
6	1.784 (45.31)	1.534 (38.96)	1.242 (31.55)	1.093 (27.76)	.781 (19.84)
10	2.411 (61.24)	2.156 (54.76)	1.870 (47.49)	1.719 (43.66)	1.406 (35.71)
12	2.724 (69.19)	2.468 (62.69)	2.181 (55.40)	2.031 (51.59)	1.718 (43.64)
15	3.194 (81.13)	2.937 (74.60)	2.650 (67.31)	2.504 (63.60)	2.187 (55.55)
18	3.664 (93.07)	3.406 (86.51)	3.120 (79.25)	2.968 (75.36)	2.656 (67.46)
22	4.291 (108.99)	4.031 (102.39)	3.747 (95.17)	3.593 (91.26)	3.281 (83.34)
28	5.227 (132.77)	4.968 (126.19)	4.683 (118.95)	4.529 (115.04)	4.219 (107.16)
**36	6.477 (164.51)	6.210 (157.73)	5.928 (150.57)	5.772 (146.60)	5.460 (138.68)

**36 card slot contains two .056 (1.42) barriers: one between contacts N & P, and one between contacts b & c.

143 series

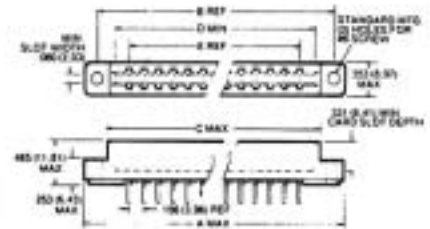

143 series commercial and industrial connectors – card guide connectors (110) deviation (special order)

Card guides extend 1 3/8" (34.92 mm) above main body of connector. These integral card guides provide positive alignment in blind installations and prevent board rocking. Has .100 (2.45 mm) more block width than standard 143 line. Available in 15, 18 and 22 position sizes with slots between contacts for plastic keys (P/N 143-754) to permit polarization without loss of contacts.

order information

For blue mineral-filled diallyl phthalate insulator, order 143-OXX-XX (110).

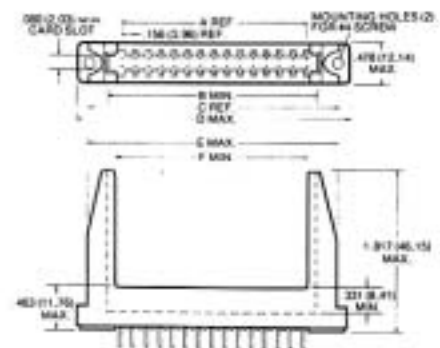

dimensions

POSITIONS	A REF.	B MIN.	C REF.	D MAX.	E MAX.	F MIN.
15	2.184 (55.47)	2.500 (63.50)	2.934 (74.52)	3.201 (81.31)	2.941 (74.70)	2.250 (57.15)
18	2.652 (67.36)	2.968 (75.39)	3.406 (87.51)	3.664 (93.07)	3.404 (86.46)	2.728 (69.29)
22	3.276 (83.21)	3.593 (91.26)	4.031 (102.39)	4.291 (108.99)	4.031 (102.38)	3.350 (85.09)

*Non-stocking item — Consult factory for delivery.



WPI - Salem Division
 23 Front Street, Salem, NJ 08079 U.S.A.
 phone (609) 935-7601
 fax (609) 935-0102 twx (510) 680-4750
 country code 1

225 series printed circuit connectors

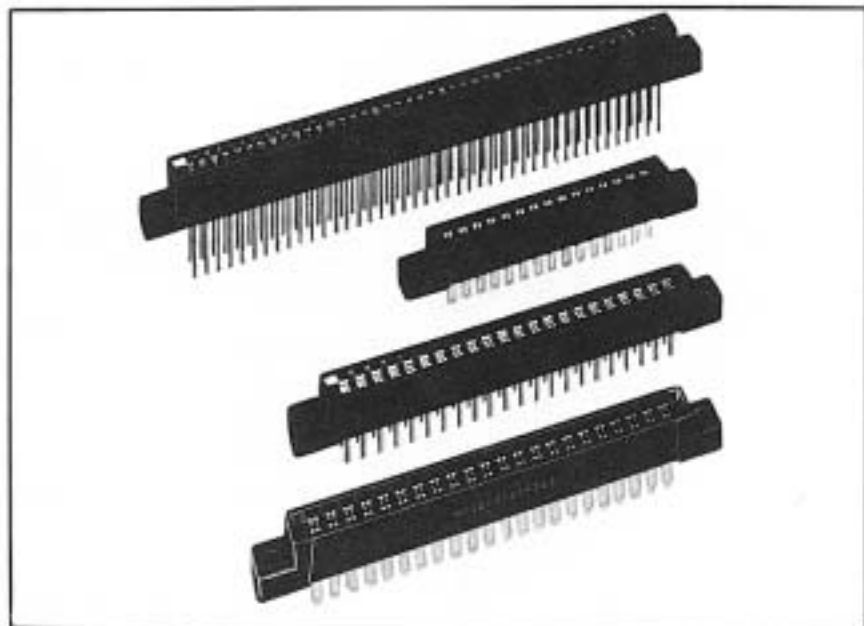

**recommended
225 series
P.C. board cutouts**

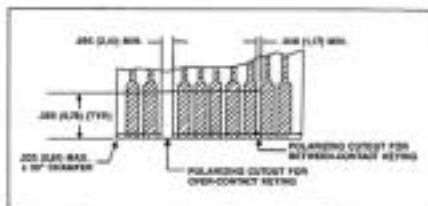

specifications

commercial connectors

operating voltage:
600 VAC (RMS) at sea level
150 VAC (RMS) at 70,000 feet

current rating:
5 amps

dielectric material:
wire wrappable type – electrical grade phenolic, black
solder type – glass filled phenolic, black

insulation resistance:
5,000 megohms minimum

contact material:
wire wrappable type – phosphor bronze plated .000020 (0.000508) min. gold over nickel

solder type - copper alloy .000020 (0.000508) min. gold over nickel

contact resistance:
30 millivolts maximum at rated current

board thickness:
.054 (1.37) to .071 (1.80)

- UL recognized (file #E115487)

industrial connectors

operating voltage:
600 VAC (RMS) at sea level
150 VAC (RMS) at 70,000 feet

current rating:
5 amps

dielectric material:
solder type – glass-fiber-reinforced diallyl phthalate type SDG-F per MIL-M-14.

insulation resistance:
5,000 megohms minimum

contact material:
solder-type - all beryllium copper except phosphor bronze for bridged contact with one tail

contact resistance:
30 millivolts maximum at rated current

board thickness:
.054 (1.37) to .071 (1.80)

military connectors qualified to MIL-C-21097 E/21

operating voltage:
600 VAC (RMS) at sea level
150 VAC (RMS) at 70,000 feet

current rating:
5 amps continuous

dielectric material:
glass-fiber-reinforced diallyl phthalate type SDG-F per MIL-M-14.

insulation resistance:
5,000 megohms minimum

contact material:
all beryllium copper except phosphor bronze for bridged contact with one tail

contact resistance:
30 millivolts maximum at rated current

board thickness:
.054 (1.37) to .071 (1.80)

WPI - Salem Division
23 Front Street, Salem, NJ 08079 U.S.A.
phone (609) 935-7601
fax (609) 935-0102 twx (510) 680-4750
country code 1



225 series commercial connectors – solder termination, folded ribbon contacts

.156" (3.96) centers x .140" (3.56) row spacing
 .156" (3.96) centers x .200" (5.08) row spacing

operating voltage:
 600 VAC (RMS) at sea level
 150 VAC (RMS) at 70,000 feet

current rating:
 5 amps

dielectric material:
wire wrappable type – electrical grade phenolic, black
solder type – glass filled phenolic, black

insulation resistance:
 5,000 megohms minimum

contact material:
wire wrappable type – phosphor bronze plated .000020 (0.000508) min. gold over nickel
solder type – copper alloy .000020 (0.000508) min. gold over nickel

contact resistance:
 30 millivolts maximum at rated current

board thickness:
 .054 (1.37) to .071 (1.80)

polarizing keys



225-559
 Over contact key must be ordered separately



225-594
 Between contact key. One included for each connector. Packed separately in bulk.

Polarization can be achieved by using either of these types of polarizing keys on all eyelet and dip solder 225 Series Connectors

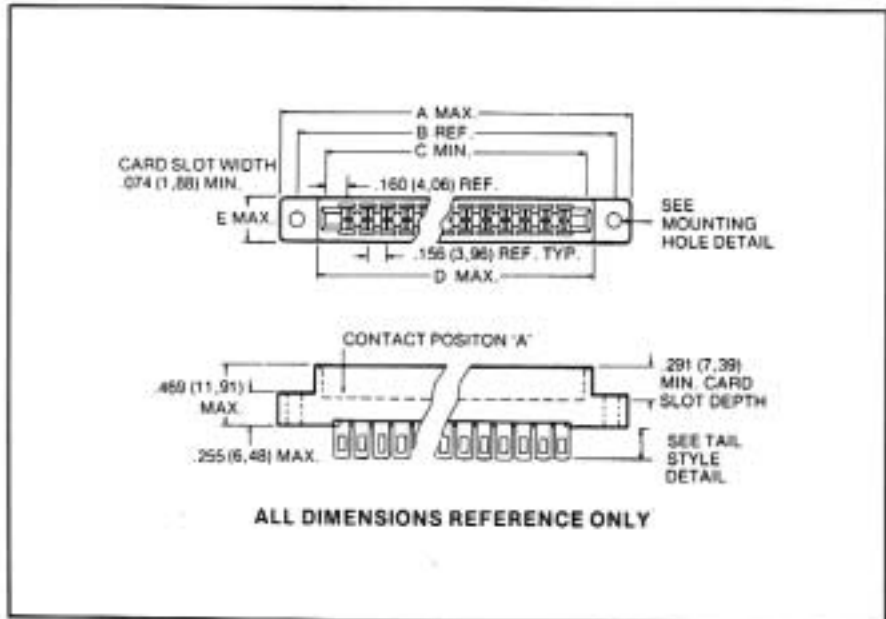
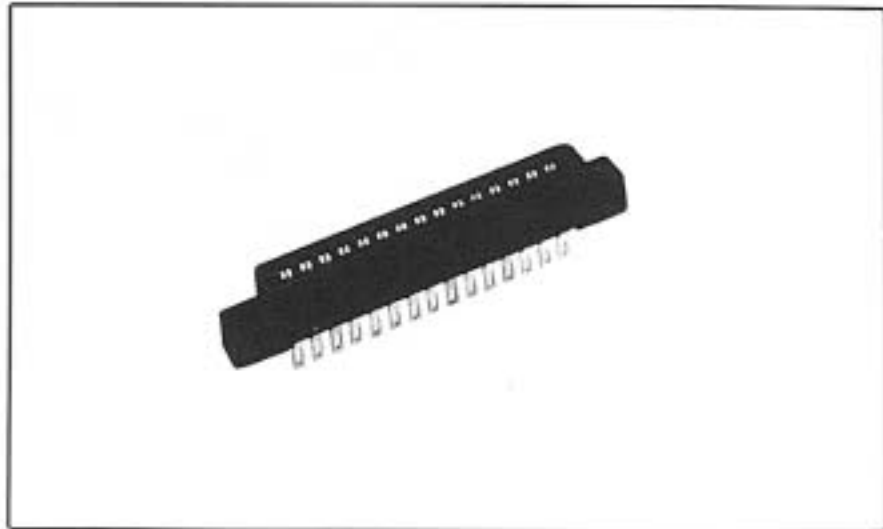

dimensions

SIZES	A MAX.	B REF.	C MIN.	D MAX.	E MAX.
06	1.864 (47.34)	1.532 (38.91)	1.095 (27.81)	1.240 (31.50)	346 (8.79)
10	2.478 (62.94)	2.156 (54.76)	1.715 (43.56)	1.864 (47.35)	346 (8.79)
15	3.258 (82.75)	2.938 (74.63)	2.494 (63.34)	2.646 (67.21)	346 (8.79)
18	3.726 (94.64)	3.406 (86.51)	2.965 (75.31)	3.115 (79.12)	346 (8.79)
22	4.350 (110.49)	4.029 (102.33)	3.584 (91.03)	3.740 (94.99)	350 (8.89)
25	4.820 (122.43)	4.496 (114.21)	4.054 (102.97)	4.204 (106.78)	346 (8.79)
28	5.274 (133.96)	4.958 (125.93)	4.512 (114.60)	4.662 (118.41)	503 (12.78)
36	6.522 (165.66)	6.213 (157.81)	5.765 (146.43)	5.910 (150.11)	503 (12.78)
43	7.610 (193.29)	7.296 (185.31)	6.854 (174.09)	7.010 (178.05)	506 (12.85)

WPI - Salem Division
 23 Front Street, Salem, NJ 08079 U.S.A.
 phone (609) 935-7601
 fax (609) 935-0102 twx (510) 680-4750
 country code 1



225 series commercial connectors – solder termination

order information

To order the 225 series connector required, put together the part number as per the following example:

2 2 5 - 2 0 6 2 1 - 4 01 (117)

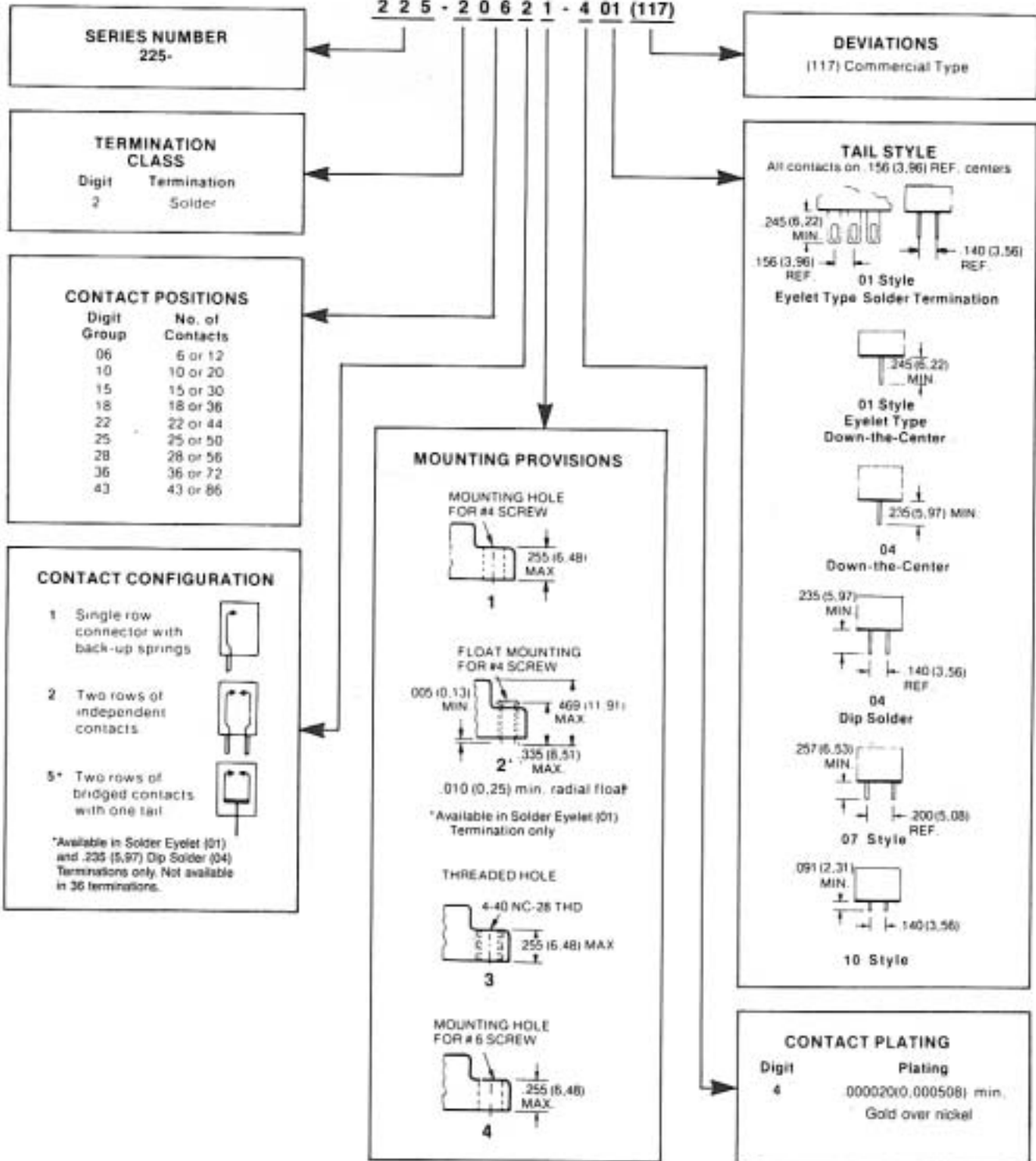

WPI - Salem Division
23 Front Street, Salem, NJ 08079 U.S.A.
phone (609) 935-7601
fax (609) 935-0102 twx (510) 680-4750
country code 1

225 series industrial connectors – solder termination, bifurcated bellows contacts

.156" (3.96) centers x .140" (3.56) row spacing

.156" (3.96) centers x .200" (5.08) row spacing

operating voltage:

600 VAC (RMS) at sea level
150 VAC (RMS) at 70,000 feet

current rating:

5 amps

dielectric material:

solder type - blue glass-fiber-reinforced diallyl phthalate type SDG-F per MIL-M-14.

insulation resistance:

5,000 megohms minimum

contact material:

solder-type - all copper alloy except phosphor bronze for bridged contact with one tail

contact resistance:

30 millivolts maximum at rated current

board thickness:

.054 (1.37) to .071 (1.80)

polarizing keys



225-559
Over contact key must be ordered separately.

225-594
Between contact key. One included for each connector. Packed separately in bulk.

Polarization can be achieved by using either of these types of polarizing keys on all eyelet and dip solder 225 Series Connectors.

dimensions

SIZES	A MAX.	B REF.	C MIN.	D MAX.	E MAX.
06	1.854 (47.09)	1.532 (38.91)	1.095 (27.81)	1.240 (31.50)	346 (8.79)
10	2.478 (62.94)	2.156 (54.76)	1.719 (43.66)	1.864 (47.35)	346 (8.79)
15	3.258 (82.75)	2.938 (74.63)	2.499 (63.47)	2.646 (67.21)	346 (8.79)
18	3.726 (94.64)	3.406 (86.51)	2.967 (75.36)	3.115 (79.12)	346 (8.79)
22	4.360 (110.74)	4.032 (102.41)	3.591 (91.21)	3.750 (95.25)	350 (8.89)
28	5.274 (133.96)	4.964 (126.08)	4.525 (114.93)	4.662 (118.41)	503 (12.78)
36	6.522 (165.66)	6.219 (157.96)	5.773 (146.63)	5.910 (150.11)	503 (12.78)
43	7.610 (193.29)	7.302 (185.47)	6.866 (174.39)	7.010 (178.05)	503 (12.78)

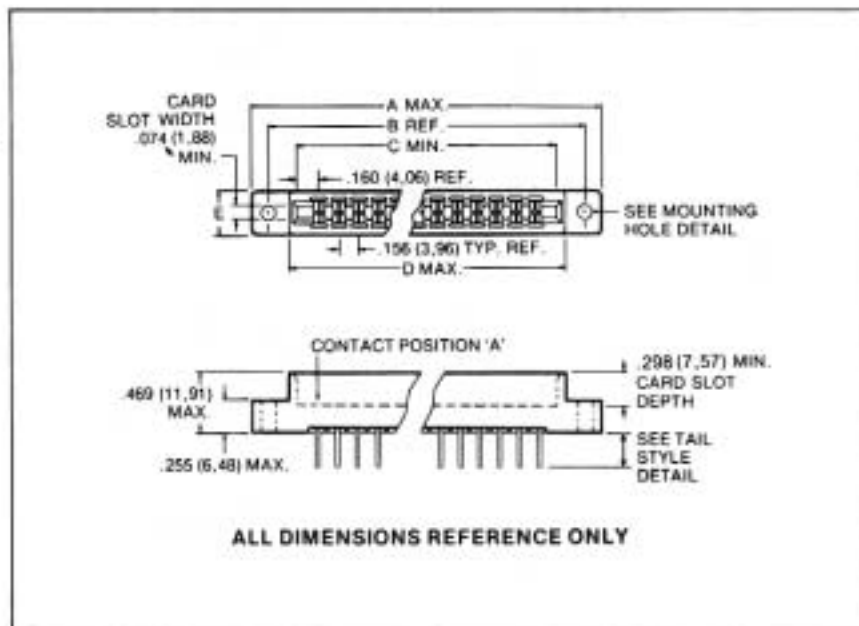
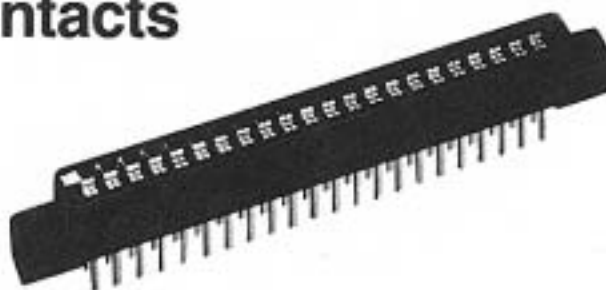

WPI 225 series printed circuit industrial connectors with solder terminations are intended for flush installation on printed circuit boards with pads and spacer barriers that permit thorough flux washing. Connectors with solder eyelets will accept up to three #20 AWG wires. All dip-solder terminals are designed for .043" (1.09 mm) min. diameter holes.

WPI - Salem Division
23 Front Street, Salem, NJ 08079 U.S.A.
phone (609) 935-7601
fax (609) 935-0102 twx (510) 680-4750
country code 1



225 series industrial connectors — solder termination

order information

To order the 225 series connector required, put together the part number as per the following example:

2 2 5 - 2 0 6 2 1 - 1 0 1

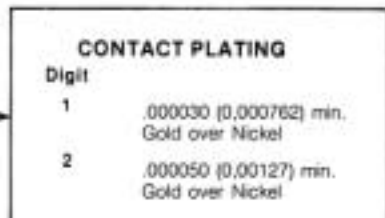
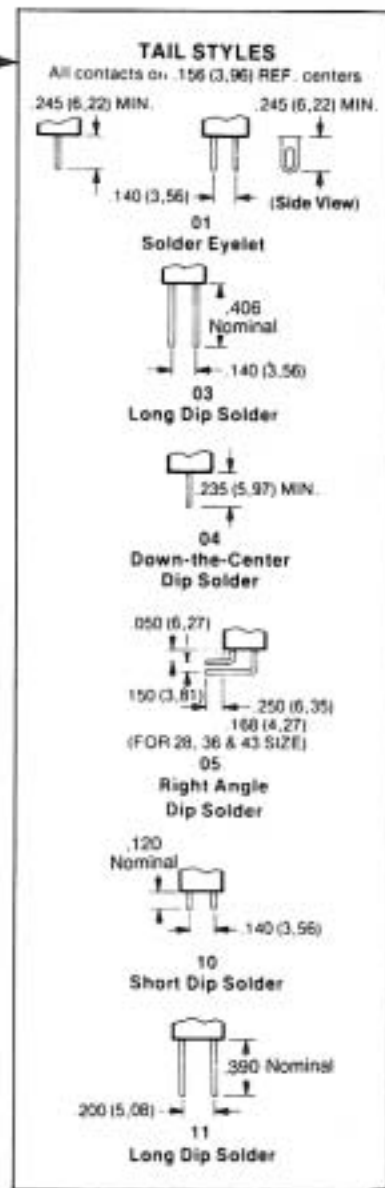
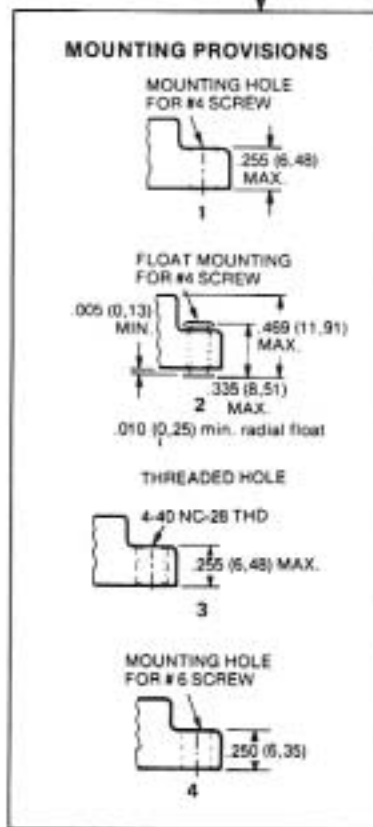
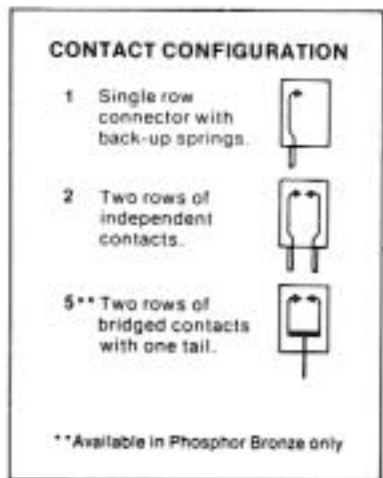
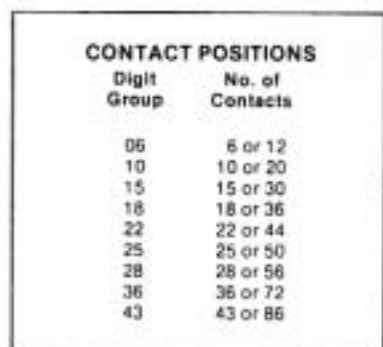
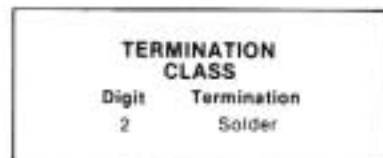
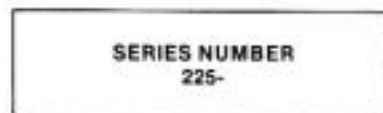

WPI - Salem Division
23 Front Street, Salem, NJ 08079 U.S.A.
phone (609) 935-7601
fax (609) 935-0102 twx (510) 680-4750
country code 1

225 series military qualified connectors - solder termination, bifurcated bellows

MIL-C-21097 E/21

.156" (3.96) centers x .140" (3.56)
row spacing
.156" (3.96) centers x .200" (5.08)
row spacing

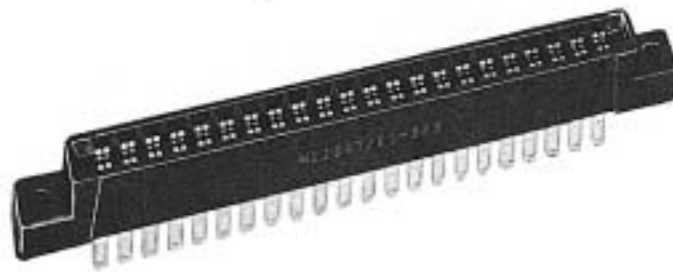

operating voltage:

600 VAC (RMS) at sea level
150 VAC (RMS) at 70,000 feet

temperature range:

-65°C to +125°C
(-85°F to +257°F)

contact material:

all beryllium copper except phosphor
bronze for bridged contact with one
tail

contact resistance:

30 millivolts maximum at rated current

board thickness:

.054 (1.37) to .071 (1.80)

current rating:

5 amps continuous

dielectric material:

blue glass-fiber-reinforced diallyl
phthalate type SDG-F per MIL-M-14.

insulation resistance:

5,000 megohms minimum

polarizing keys



225-559

Over contact key must be ordered
separately.



225-594

Between contact key. One includ-
ed for each connector. Packed
separately in bulk.

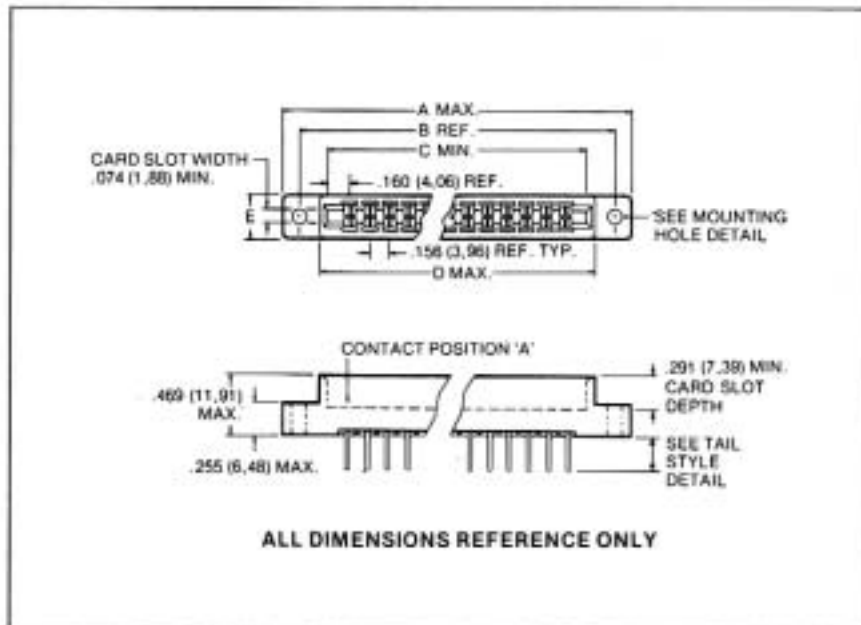

WPI 225 series printed circuit
military connectors with solder
terminations are intended for flush
installation on printed circuit boards
with pads and spacer barriers that
permit thorough flux washing.
Connectors with solder eyelets will
accept up to three #20 AWG wires.
All dip-solder terminals are designed
for .043" (1.09 mm) min. diameter
holes.

dimensions

SIZES	A MAX.	B REF.	C MIN.	D MAX.	E MAX.
06	1.854 (47.09)	1.532 (38.91)	1.095 (27.81)	1.240 (31.50)	.346 (8.79)
10	2.478 (62.94)	2.156 (54.76)	1.719 (43.66)	1.864 (47.35)	.346 (8.79)
15	3.258 (82.75)	2.938 (74.63)	2.499 (63.47)	2.646 (67.21)	.346 (8.79)
18	3.726 (94.64)	3.406 (86.51)	2.967 (75.36)	3.115 (79.12)	.346 (8.79)
22	4.360 (110.74)	4.032 (102.41)	3.591 (91.21)	3.750 (95.25)	.350 (8.89)
28	5.274 (133.96)	4.964 (126.08)	4.525 (114.93)	4.662 (118.41)	.503 (12.78)
36	6.522 (165.66)	6.219 (157.96)	5.773 (146.63)	5.910 (150.11)	.503 (12.78)
43	7.610 (193.29)	7.302 (185.47)	6.866 (174.39)	7.010 (178.05)	.503 (12.78)

WPI - Salem Division
23 Front Street, Salem, NJ 08079 U.S.A.
phone (609) 935-7601
fax (609) 935-0102 twx (510) 680-4750
country code 1



225 series military qualified connectors — solder termination

MIL-C-21097 E/21

order information

To order the 225 series connector required, put together the part number as per the following example:

2 2 5 - 2 0 6 2 1 - 2 0 1

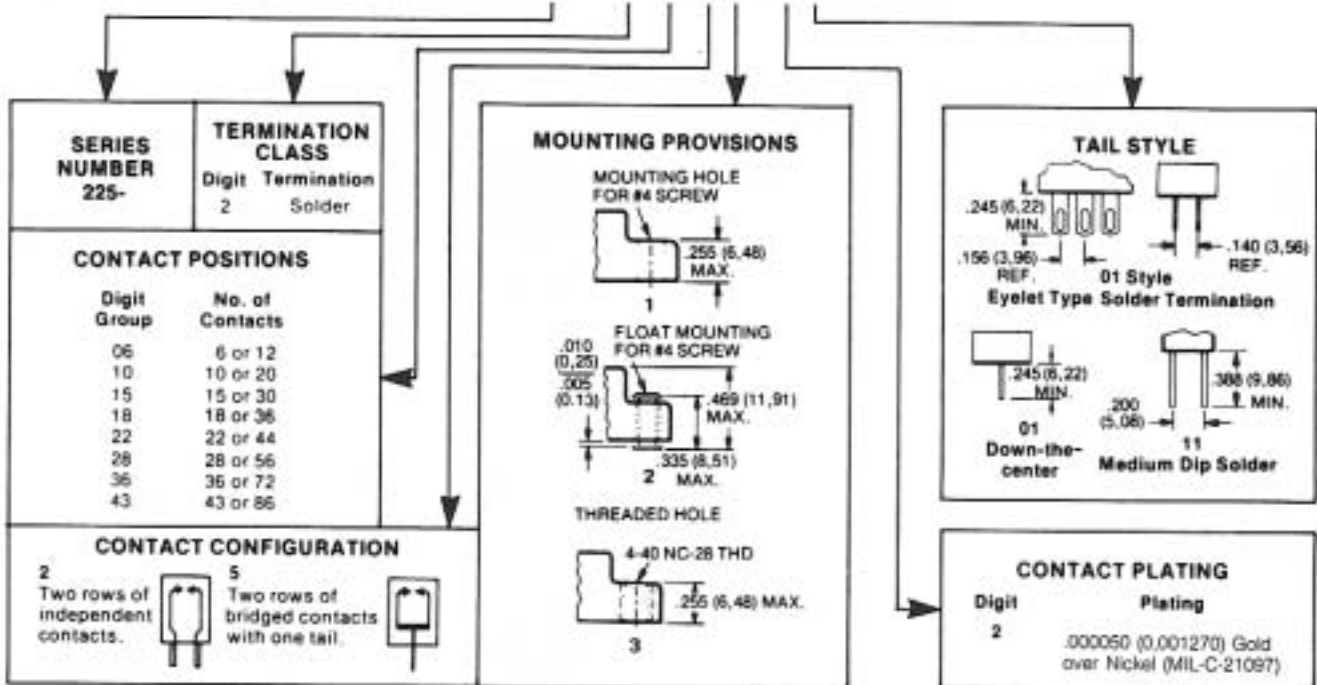

cross reference to MIL-C-21097E /21 (Also to MIL-C-21097/1)

Military Number	WPI Number	Military Number	WPI Number	Military Number	WPI Number	Military Number	WPI Number
M21097E/21-001	225-20651-201	M21097E/21-073	225-21561-201	M21097E/21-145	225-22201-201	M21097E/21-235	225-23621-201*
-004	-20653-201*	-076	-21563-201*	-148	-22203-201*	-236	-23623-201*
-007	-20652-201*	-079	-21562-201*	-151	-22252-201*	-241	-23622-201*
-019	-20621-201	-091	-21521-201	-163	-22221-201	-244	-23621-211*
-022	-20623-201*	-094	-21523-201*	-166	-22223-201*	-247	-23623-211*
-025	-20622-201*	-097	-21522-201*	-169	-22222-201*	-250	-23622-211*
-028	-20821-211*	-100	-21521-211*	-172	-22221-211*	-271	-24321-201
-031	-20823-211*	-103	-21523-211*	-175	-22223-211*	-274	-24323-201*
-034	-20822-211*	-106	-21522-211*	-178	-22222-211*	-277	-24322-201*
-037	-21051-201	-109	-21851-201	-181	-22851-201	-280	-24321-211*
-040	-21053-201*	-112	-21853-201*	-184	-22853-201*	-283	-24323-211*
-043	-21052-201*	-115	-21852-201*	-187	-22852-201*	-286	-24322-211*
-055	-21021-201	-127	-21821-201	-199	-22821-201		
-058	-21023-201*	-130	-21823-201*	-202	-22823-201*		
-061	-21022-201*	-133	-21822-201*	-205	-22822-201*		
-064	-21021-211*	-136	-21821-211*	-208	-22821-211*		
-067	-21023-211*	-139	-21823-211*	-211	-22823-211*		
-070	-21022-211*	-142	-21822-211*	-214	-22822-211*		

NOTE: Above parts include 4 keys. Part Number 225-594 (M21097/11-08).

*Non-stocking item—
Consult factory for delivery.

125 V plugs and receptacles

Components UL recognized . . . for specifics, see charts below

mounting plate type

Cadmium plated steel mounting plate assembled to molded thermo-plastic body. Mounting hole: $1\frac{9}{32}$ " (32.54) dia. with two $\frac{9}{64}$ " (3.57) slots on $1\frac{1}{2}$ " (38.10) to $1\frac{55}{64}$ " (47.22) centers.

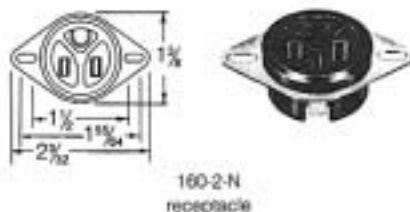

160-2-N
receptacle

MOUNTING PLATE TYPE

Description	WPI Number	UL
2 Pole Receptacle Phosphor Bronze Contacts	160-2-N	UL
2 Pole Plug Brass Contacts	160-3-N	UL

flush motor type

Consists of inserts assembled in cadmium plated steel shells for below surface mounting. Mounting hole: $1\frac{7}{16}$ " (36.53) dia. hole with two $\frac{5}{32}$ " (3.96) screw holes on $1\frac{3}{4}$ " (44.45) centers.

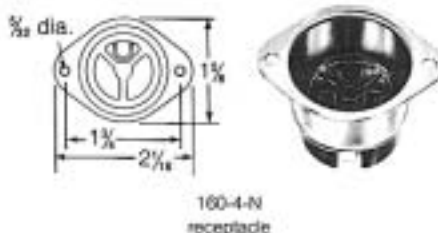

160-4-N
receptacle

FLUSH MOTOR TYPE

Description	WPI Number	UL
2 Pole Flush Motor Receptacle	160-4-N	UL
2 Pole Flush Motor Plug	160-5-N	UL

shielded type

Consists of inserts with sturdy steel plug caps finished in black epoxy. Plug caps: $1\frac{1}{16}$ " (26.97) long. End nylon bushing: $\frac{13}{32}$ " (10.31) I.D. Cable clamp: fits $\frac{3}{8}$ " (9.52) O.D. cables.

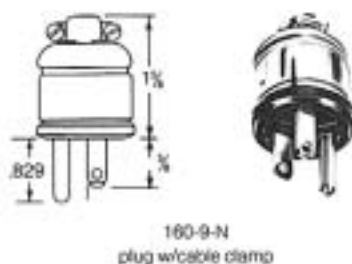

160-9-N
plug w/cable clamp

SHIELDED TYPE

Description	WPI Number	UL
2 Pole Shielded Receptacle w/Nylon Bushing	160-6-N*	UL
2 Pole Shielded Plug w/Nylon Bushing	160-7-N*	UL
2 Pole Shielded Receptacle w/Cable Clamp	160-8-N*	UL
2 Pole Shielded Plug w/Cable Clamp	160-9-N*	UL

inserts

High temperature thermo-plastic bodies. Zinc plated retaining ring. Copper alloy contacts. Mounted in $1\frac{11}{64}$ " (29.77) keyed hole. Grooved to fit $.031$ " - $(.079)$ - $.050$ " (1.27) thick panels.

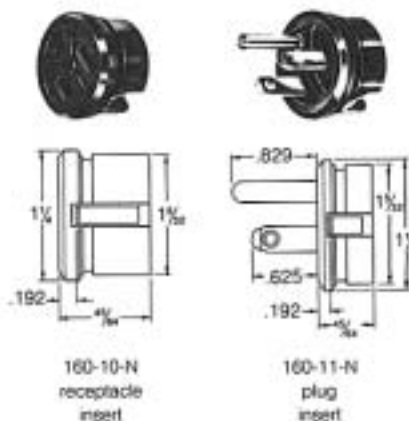

160-10-N
receptacle
insert

160-11-N
plug
insert

INSERTS

Description	WPI Number	UL
2 Pole Receptacle Insert	160-10-N	UL
2 Pole Plug Insert	160-11-N	UL

*Non-stocking item —
Consult factory for delivery.

UL listing file
#E116778
recognized under
file #E115487



220 series contacts

FOR 221, 222, 223 SERIES CONNECTOR

Ultra-Tac Contacts

Top quality micro-miniature contacts. The socket contacts are hooded to resist test prod damage.

Relia-Tac Contacts

Durable, customer-proven contacts.

Part Number	Description
220-P02 (Pin) 220-S02 (Socket)	Standard, See specifications below
220-844-02 (Pin) 220-845-02 (Socket)	Same as above, except heavy gold plating and inspection hole in crimp area

specifications

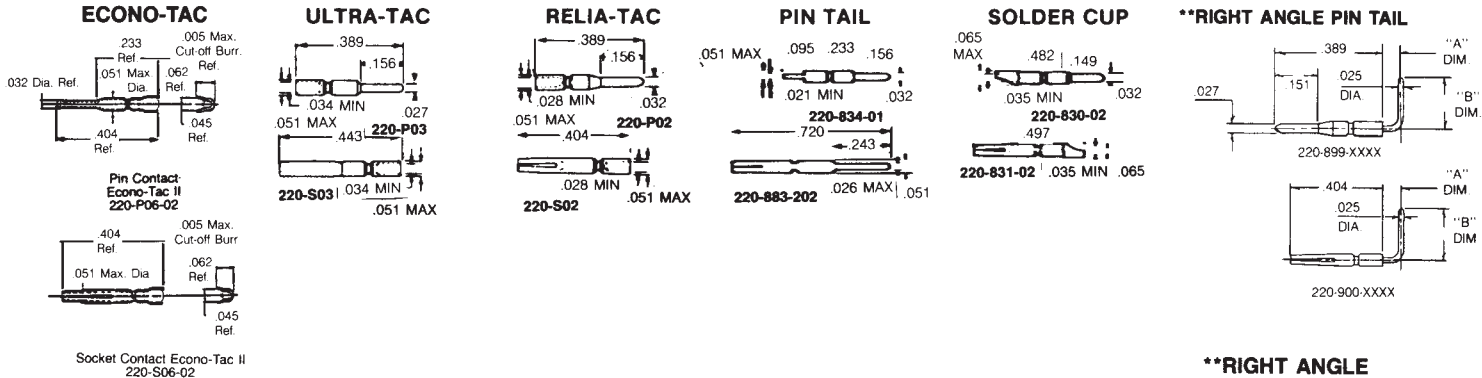

	ECONO-TAC	ULTRA-TAC	RELIA-TAC	PIN TAIL	SOLDER CUP	**RIGHT ANGLE PIN TAIL
Current (Amps) Rating	5	5	5	5	5	5
Contact Resistance* (ohms)	.0060	.0060	.0060	.0050 to .0060	.0060	.0060
Wire Range (Ga.) (Solid & Stranded)	24,26,28	22,24,26	24,26,28	N/A	24,26,28	N/A
Contact Finish	Gold-over-Copper on Copper Alloy Bodies	Gold-over-Copper on Copper Alloy Bodies	Gold-over-Copper on Copper Alloy Bodies	Gold-over-Copper on Copper Alloy Bodies	Gold-over-Copper on Copper Alloy Bodies	Gold-over-Copper on Copper Alloy Bodies

* Constant to a minimum of 100 cycles of insertion and withdrawal.

Ordering Information

Minimum order quantity is 100 pieces.
Contacts can be supplied on reels for use in semi-automatic, crimp machines.
Contact factory.

NOTE: All socket contacts are completely shrouded within the plug inserts for optimum protection against damage. Pin contacts are normally exposed when assembled into receptacle inserts.

**Right Angle Pin Tail Dimensions

Pin	Socket	"A"	"B"	Series Used On
220-899-01XX	—	.166	.306	223
—	220-900-01XX	.166	.306	223
220-899-02XX	—	.080	.220	223
—	220-900-02XX	.080	.220	223
220-899-03XX	—	.080	.172	221
—	220-900-03XX	.080	.172	221
—	220-900-04XX	.180	.306	223

NOTE: Substitute XX with:
02 - .000020" Gold over Nickel
03 - Bright Tin/Lead



WPI - Salem Division
23 Front Street, Salem, NJ 08079 U.S.A.
phone (609) 935-7601
fax (609) 935-0102 twx (510) 680-4750
country code 1

221 series strip connectors

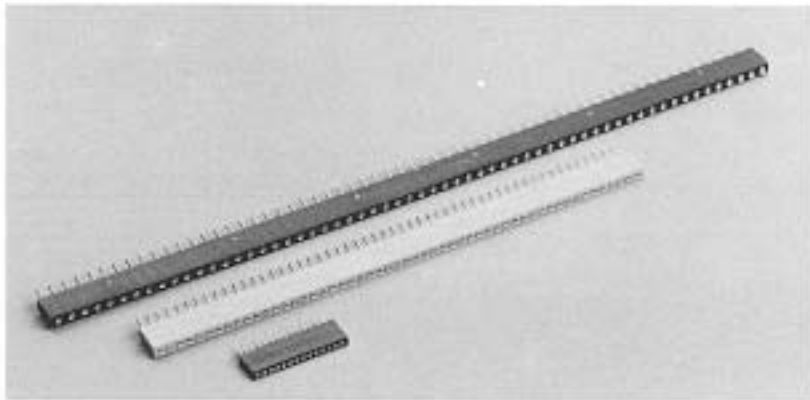

WPI Strip Connectors are highly reliable, low cost micro-miniatures with great application versatility. They are furnished in 4" and 6" lengths, but you can cut and stack them to whatever configuration you need to satisfy your various application requirements.

Strip connectors use Poke-Home contacts and perform superbly. Where keying is desired, guide pins are inserted in two or more plug strip contact holes.

Because Strip connectors are injection molded, special configurations can be produced quickly and inexpensively.



Strips can be used in stacked arrangement. Should be stacked parallel only.



PC board application using strip connectors.

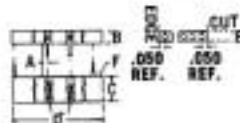

CUSTOM LENGTH

Number of holes multiplied by contact center dimension equals approximate length of strip.

dimensions

Description	A Contact Centers	B	C	D	E	F Contact Positions
6" Plug Strip	.100	—	.456	6.00	.105	60
6" Receptacle Strip	.100	.230	—	6.00	.105	60
4" Plug Strip	.075	—	.456	4.00	.105	53
4" Receptacle Strip	.075	.230	—	4.00	.105	53
4" Plug Strip	.050	—	.281	4.00	.075	80
4" Receptacle Strip	.050	.218	—	4.00	.075	80

Strain Relief Strips Protect Wire

WPI has a solution to the problem of excessive flexing that breaks wire strands in cable-terminated applications. Strain relief strips are available to encase and protect the wire in the crimp area at the rear of the strips. Molded in black Nylon 6/6 material, the strips can be ordered to match any WPI strip connector. Held in place by retention pins, which can also be used as a guide pin.

Ordering Information

- 221-9160—for use with strip connectors on .100 ctrs.
- 221-9253—for use with strip connectors on .075 ctrs.
- 221-9380—for use with strip connectors on .050 ctrs.

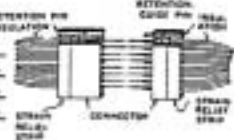

Mini-Tac Contacts

(Sub-miniature Relia-Tac contacts for .050" center mini-strip connectors only).
Current Rating: 3 Amps.
Wire Size: 26 to 32 ga. stranded wire.

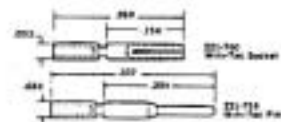

Ordering Information

Standard and custom lengths.



Number of Contact Holes needed: from 02 to 60 on .100 centers (standard 6" strip contains 60 holes); from 02 to 53 on .075 centers (standard 4" strip contains 53 holes); from 02 to 80 on .050 centers (standard 4" strip contains 80 holes).
Note: Must use 2 digits.

Note: Order Contacts Separately

Use Relia-Tac pin contacts for receptables; socket contacts for plugs.

WPI - Salem Division
 23 Front Street, Salem, NJ 08079 U.S.A.
 phone (609) 935-7601
 fax (609) 935-0102 twx (510) 680-4750
 country code 1



222 series — Mighty Mite[®] connectors

19 to 61 Contacts — .085 Contact Centers

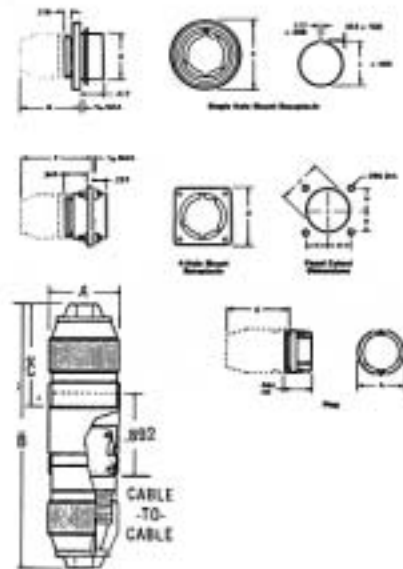
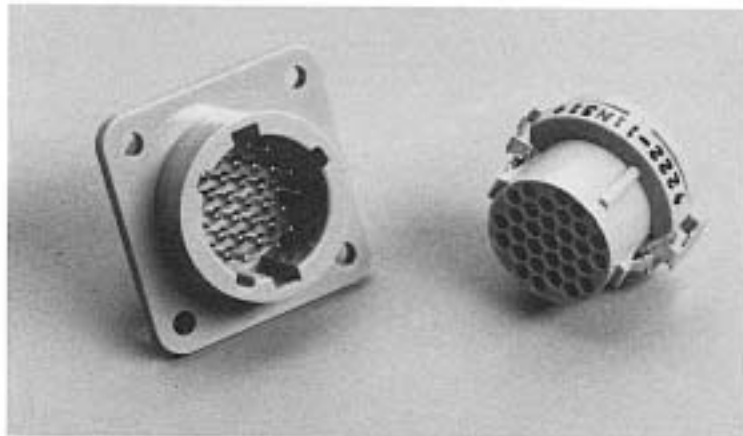

Superior Performance at Low Cost

WPI Mighty-Mite connectors are low cost, highly reliable micro-miniature connectors designed to serve an exceptionally wide range of cable-to-cable and cable-to-chassis applications.

Mighty-Mite connectors are available as straight plus, single hole mounting, square flange, and cable receptacles. Standard connectors are molded of one-piece, rugged polycarbonate.

arrangements

inserts available (Showing front face of plug insert)

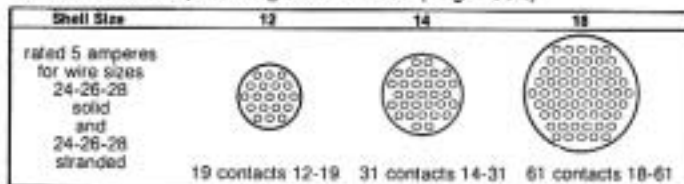

	No. of Contacts		
	19	31	61
A ref. diameter	.621	.746	.896
B ref. length	2.618	2.948	3.530
C ref. length	.962	1.134	1.418
D ref. square	.875	1.000	1.250
E ref. diameter	1.066	1.189	1.444
F ref. length	1.278	1.450	1.734
G ref. length	1.084	1.256	1.540
H length	.312	.375	.500
J diameter	.636	.761	1.011
Strain Relief Assembly No.	222-518	222-519	222-520
Retaining Ring No.	2-311	2-312	2-313

ordering information

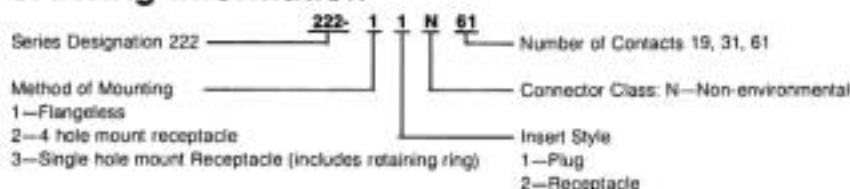

Note: Order Contacts Separately



WPI - Salem Division
23 Front Street, Salem, NJ 08079 U.S.A.
phone (609) 935-7601
fax (609) 935-0102 twx (510) 680-4750
country code 1

223 series – Tiny Tim® connectors

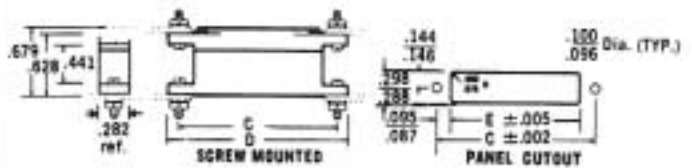
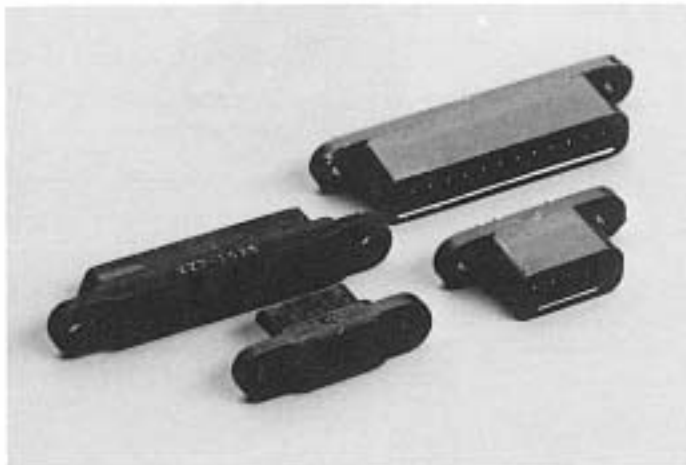

Exceptional interconnections for circuit modules, either potted-in or surface mounted, and can also be used as micro-miniature rack-and-panel, cable-to-cable, and cable-to-panel connectors.

The positive mating is the result of the snap latch engagement locking device molded into the connector body. Contact identification numbers are also molded in.

Trapezoidal mating faces are used for polarization. Guide pins provide keying. Contact spacing is .100" on centers on each row.

specifications

Temperature Range: -55°C to +125°C

Current Rating: 3 amps (Econo-Tac II contacts)
5 amps (all other contacts)

Voltage Rating: 600 VAC (RMS) at sea level
125 VAC (RMS) at 70,000 ft.

Dielectric: Glass-filled nylon (polycarbonate resin also available)

Strain relief 223-714-09 — 9 contacts; 223-714-17 — 17 contacts; 223-714-25 — 25 contacts; 223-714-44 — 33 contacts.

dimensions

No. of Contacts	E Length of Cutout	C Mounting Centers	D ref. Overall Length
5	.410 (10.414)	.593 (15.052)	.843 (21.438)
9	.610 (15.494)	.793 (20.142)	1.043 (26.518)
17	1.015 (25.781)	1.193 (30.302)	1.443 (36.678)
25	1.410 (35.814)	1.593 (40.462)	1.843 (46.838)
33	1.810 (45.974)	1.993 (50.622)	2.243 (56.998)

Use Relia-Tac pin contacts for receptacles, socket contacts for plugs.

Strain Relief

Thermoplastic cable clamp strain relief housings for use with above connectors:

Contact Size	Part No.	Contact Size	Part No.
9	223-714-09	25	223-714-25
17	223-714-17	33	223-714-33

ordering information

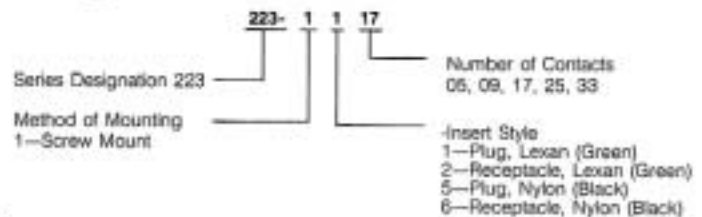

NOTE: Order Contacts Separately. See Section 9 Page 1



military audio connectors 5 & 6 contact MIL-C-55116

U-183/U Receptacle

Spring-loaded contacts, **five or six contacts**, solder terminals.
Also available with printed circuit terminals.

U-229/U Plug

Rigid contacts, barrel pin terminals, **five or six contacts**. Also available
with solder terminals.

Consult factory for additional specials and modifications.

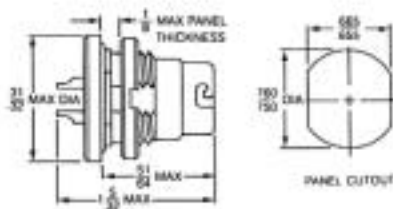

U-183-/U

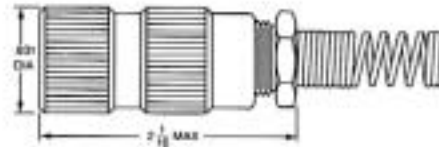

U-229/U

material & finish

shells: stainless steel, passivated, sand-blasted

panel nuts: stainless steel, passivated, sand-blasted

contacts: copper alloy, .000030 gold per MIL-G-45204,
Type I class 0 over .001 nickel per QQ-N-290

insulators: diallyl phthalate per MIL-M-14F, Type MDG

electrical specifications

dielectric strength: 500 V RMS

insulation resistance: 1000 Megohms. Min.

contact resistance (mated): 0.050 Ohms. Max.

mechanical specifications

air pressure: 2.5 psi.

immersion: 48 hrs. at 6 ft.

durability: 3000 cycles, mate and unmated



WPI - Salem Division
23 Front Street, Salem, NJ 08079 U.S.A.
phone (609) 935-7601
fax (609) 935-0102 twx (510) 680-4750
country code 1

military audio connectors (cont.)

10 contact MIL-C-10544

U-79/U Receptacle

Spring-loaded contacts, solder terminals. Also available with printed circuit terminals.

U-77/U Plug

Rigid contacts, solder terminals.

Consult factory for additional specials and modifications.

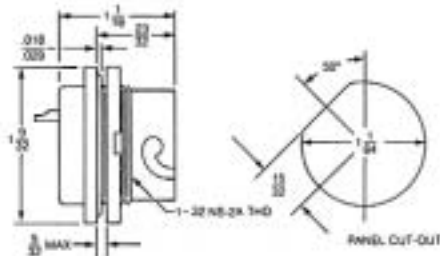

U-79/U

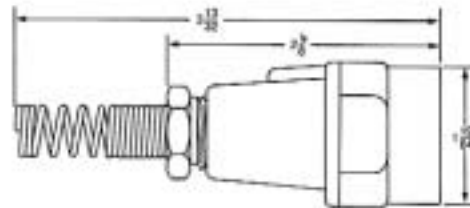

U-77/U

material & finish

receptacle shells: stainless steel, passivated, sand-blasted

plug shells: stainless steel, black passivated

plug rear housings: aluminum, black anodized

panels nuts: stainless steel, passivated, sand-blasted

contacts: copper alloy, .0002 silver

insulators: diallyl phthalate per MIL-M-14F, Type MDG

electrical specifications

dielectric strength: 500 V RMS

insulation resistance: 1000 Megohms. Min.

contact resistance (mated): 0.015 Ohms. Max.

mechanical specifications

air pressure: 2.5 psi

immersion: 48 hrs. at 6 ft.

durability: 1500 cycles, mate and unmate

WPI - Salem Division
23 Front Street, Salem, NJ 08079 U.S.A.
phone (609) 935-7601
fax (609) 935-0102 twx (510) 680-4750
country code 1



military u-type power connectors

U-288/U receptacle MIL-C-55243



Multi-use, medium power receptacle. 12 # 20 pin contacts.
Used in many military communications equipment such as
AS 1729 antenna.

material & finish

body: stainless steel, cadmium plate with olive drab
chromate

contacts: copper alloy, gold per MIL-G-45204 Type II
Grade C Class I over nickel

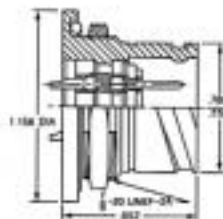

U-237 B/G power plug cable mount MIL-C-55449



U-238 B/G power receptacle panel mount MIL-C-55449



Used to supply power to area-type communications systems. Four contacts, hermaphroditic.
Consult factory for availability of other U-types.



WPI - Salem Division
23 Front Street, Salem, NJ 08079 U.S.A.
phone (609) 935-7601
fax (609) 935-0102 twx (510) 680-4750
country code 1

military MW power connectors

MIL-C-55181

MW 20 receptacles



M55181/2-01
MW20M(M)A00



M55181/4-01
MW20F(M)A00



M55181/6-01
MW20F(M)B00



M51181/8-01
MW20F(M)D00

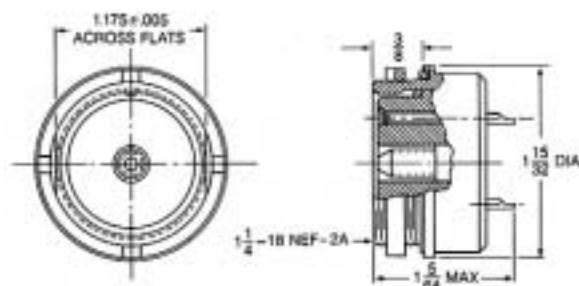

material & finish

shells, plugs: aluminum alloy, .0003 cadmium plate with olive drab chromate per MIL-F-14072

shells, receptacles: brass, .0003 cadmium plate with olive drab chromate per MIL-F-14072

drawscrews: stainless steel

contacts, socket: high conductivity copper alloy with beryllium copper spring element, .000030 gold over .0001 Ni per QQ-N-290

contacts, pin: yellow brass, .000030 gold over .0001 Ni per QQ-N-290

insulators: neoprene and/or glass-filled diallyl phthalate, type GDI-30 per MIL-M-14F

electrical specifications

dielectric strength: 4 contacts: 2000 V RMS, 9 & 18 contacts: 1500 V RMS

insulation resistance: 1000 Megohms min. at 500 V DC

voltage drop: 4 contacts: 20 MV at 35 A, 9 & 18 contacts: 25 MV at 7.5 A

mechanical specifications

air pressure: 2.5 psi

water immersion: 48 hrs. at 6 ft.

durability: 500 cycles with coupling torque of 12 in.-lbs.

contact retention: 10 lbs.

insert strength: 400 lbs.

WPI - Salem Division
23 Front Street, Salem, NJ 08079 U.S.A.
phone (609) 935-7601
fax (609) 935-0102 twx (510) 680-4750
country code 1



military UW power connectors

MIL-C-12520

plugs



UW1220



UW1320



UW1326

receptacles



UW2020



UW2026

material & finish

shells, plugs: aluminum alloy, .0003 cadmium plate with olive drab chromate per MIL-F-14072

shells, receptacles: brass, .0003 cadmium plate with olive drab chromate per MIL-F-14072

nosepieces: alloy steel, .0003 cadmium plate with olive drab chromate per MIL-F-14072

drawscrews: stainless steel

contacts, socket: high conductivity copper alloy with beryllium copper spring element, .000030 gold over .0001 copper

contacts, pin: yellow brass, .000030 gold over .0001 copper

insulators: neoprene and/or glass-filled diallyl phthalate, type GDI-30 per MIL-M-14F

electrical specifications

dielectric strength: 4, 9, & 14 contacts: 2800 V RMS, 19 & 30 contacts: 2000 V RMS

insulation resistance: 1000 Megohms min. at 500 V DC

voltage drop: 4 contacts: 20 MV at 35 A, 9, 14, 19, & 30 contacts: 21 MV at 20 A

mechanical specifications

air pressure: 2.5 psi

water immersion: 48 hrs. at 6 ft.

durability: 500 cycles with coupling torque of 25 in.-lbs.

contact retention: 15 lbs.

insert strength: 400 lbs.

part numbering system

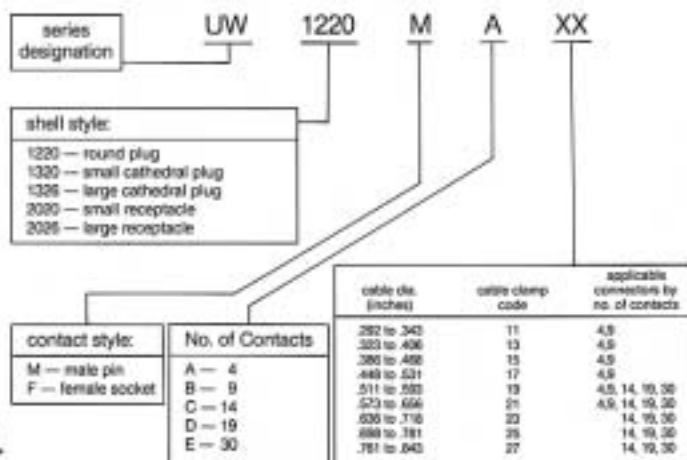

WPI - Salem Division
 23 Front Street, Salem, NJ 08079 U.S.A.
 phone (609) 935-7601
 fax (609) 935-0102 twx (510) 680-4750
 country code 1

cap and chain assemblies

164 series caps and chains greatly expand connector application possibilities by giving additional protection against moisture, dust, and sand. They are available in numerous variations of chain styles, paint and plating and may be made to meet special applications or military drawing specifications.



WPI Number	For Connector
164-377	164-7J U-79/U
164-895	164-183 U-183/U



WPI Number	USAECOM Number	Used with Connectors — UW Series
164-447	MIL-C-12520-3X	164-102-XXS, 164-202-XXS, 164-126F
164-499	MIL-C-12520-2X	164-101-XXP
164-507	MIL-C-12520-1X	164-101-XXS
164-782	MIL-C-12520-1N	164-102-XXP, 164-202-XXP, 164-126M
164-599	MIL-C-12520-3N	164-201-XXS, 164-120F
164-893-01	MIL-C-12520-2N	164-201-XXP, 164-120M

*For other cap and chain assemblies, contact factory.

WPI - Salem Division
 23 Front Street, Salem, NJ 08079 U.S.A.
 phone (609) 935-7601
 fax (609) 935-0102 twx (510) 680-4750
 country code 1



WPI® non-standard military connectors

CNI Series	ENVIRONMENTALLY-SEALED RECTANGULAR CONNECTORS
CX Series	VARIOUS MILITARY CONNECTORS AND/OR CABLE ASSEMBLY CALL OUTS
H Series	NAVAL SOUND-POWERED CONNECTORS
Q Series	MIL-C-55169 SUBMERSION-PROOF POWER CONNECTORS
ONO Series	POKE-HOME RECTANGULAR COAX CONTACT CONNECTORS
PL Series	MILITARY CIRCULAR CONNECTORS
Q2 Series	MIL-C-55169 SUBMERSION-PROOF POWER PLUGS
Q7A Series	MIL-C-55169 SUBMERSION-PROOF POWER RECEPTACLES
45 Series	MIL-C-55169 SUBMERSION-PROOF POWER CONNECTORS
84 Series	MINIATURE HIGH-TEMPERATURE "R" CONNECTORS
89 Series	SUBMERSION-PROOF POWER CONNECTORS
93 Series	POKE-HOME RECTANGULAR CONNECTORS
94 Series	POKE-HOME RECTANGULAR COMBINATION CONTACT CONNECTORS
126 Series	CNI ENVIRONMENTALLY-SEALED RECTANGULAR CONNECTORS
126 Series	MINIATURE RECTANGULAR CONNECTORS
164 Series	MILITARY POWER CONNECTORS
246 Series	ENVIRONMENT-RESISTANT CONNECTORS

Consult factory for specifications,
samples, pricing, and delivery information.



WPI - Salem Division
23 Front Street, Salem, NJ 08079 U.S.A.
phone (609) 935-7601
fax (609) 935-0102 twx (510) 680-4750
country code 1

termination tooling for 17/117/220 series

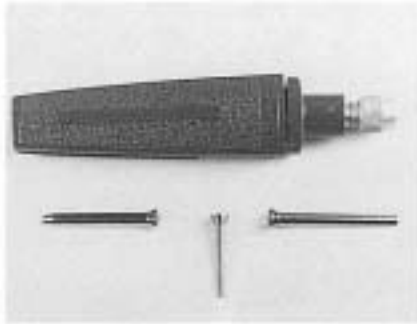

insertion tool

356-200 - tool handle only. Select correct insertion or removal bit from chart



removal tool

356-271 - for 117/177/777 rear-release series - replaceable tips

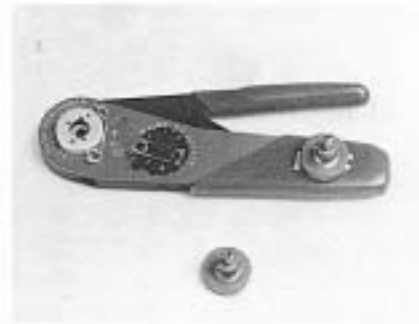

hand crimp tool

357-100 - adjustable, 4-indent miniature to MIL-C-22520. Requires contact locator bushing. For specific contact used, see section 15, page 3.

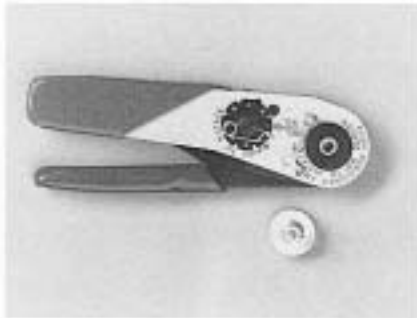

hand crimp tool for mini-tac contacts

357-101 - adjustable, 4-indent miniature to MIL-C-22520. Requires contact locator bushing. For specific contact used, see section 15, page 3.



hand crimp tool

357-570 - used to crimp contacts - 220 stamped & formed



hand crimp tool

357-574 - Used to crimp contacts 17 - RRDX - FXX, 17 - RRDX - MXX 20-30 AWG wire.

crimping procedure for 357-574 crimp tool

1. With locator side of tool facing downward, be sure that tool is completely open.
2. Place contact crimp barrel on correct anvil with open end facing toward crimper.
3. Properly locate contact by nesting slot in front of wire crimp barrel onto clip of locator. This should align both wire and insulation crimp barrels with their respective crimping jaws.
4. Slowly close handles until contact is locked into crimping die. Do not over-close.
5. Insert stripped wire to maximum depth. Be sure all strands of wire are inside barrel.
6. Close handles until ratchet disengages. Ratchet insures tool has completed crimp cycle and contact has been crimped before tool re-opens.

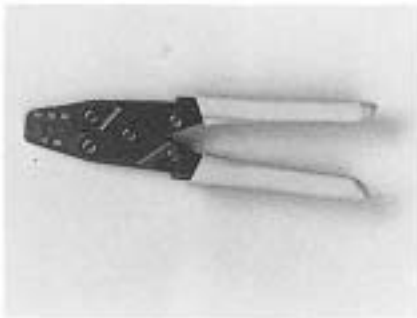

hand crimp tool

357-2500 - economy tool for 117 rear-release contacts - ideal for occasional use

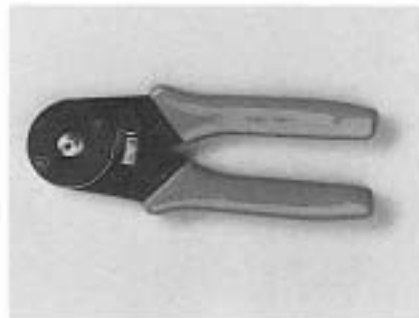

hand crimp tool

357-2501 - economy tool for 17 series - standard crimp contacts

termination tooling



manual-feed pneumatic crimp tool 359-401 - 4-indent, cycle-controlled, less contact locator bushing. See chart for correct locator bushings and settings.

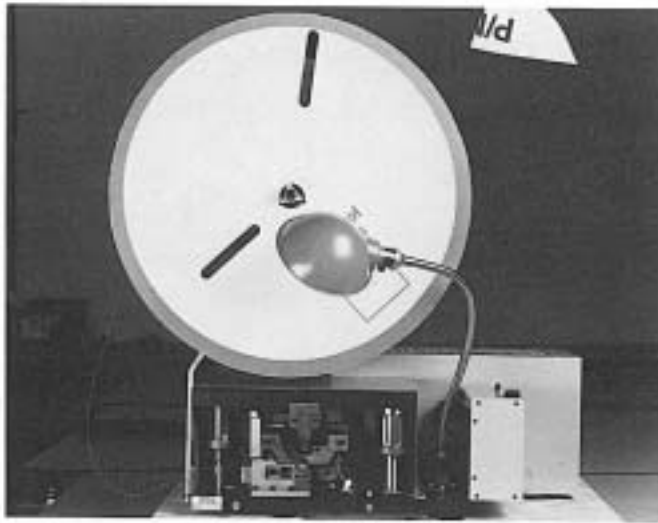

semi-automatic stripper/crimper machine 359-634 - strips and terminates discrete wire to open barrel, reel fed contacts. Used on stamped and formed 117 series contacts, auto-feed system maximizes production of crimp terminations of non-metallic insulated wire in ranges of #30-20 AWG. Termination rates can easily exceed 1500 wires per hour.

specifications
 crimping speed:
 up to 2,000 terminations per hour
 contacts:
 17 - RRDX - FXX male and 17 - RRDX - M02 female stamped and formed rear release contacts.
 wire size:
 20 to 24 guage AWG
 24 to 30 guage AWG
 dimensions:
 33" wide x 21" deep x 13½" high.
 weight:
 190 lbs (approx.)
 electrical requirements:
 110 VAC standard 3 wire grounded supply
 Meets all applicable OSHA standards.

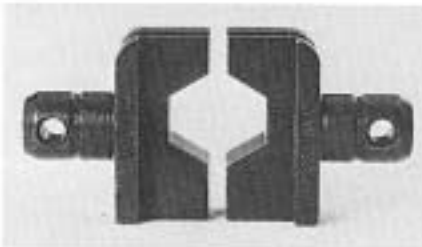

crimp die 357-315-03
 hexagonal clamp die for use with hand crimp tool (357-115). For overmold can.



hand crimp tool 357-115
 economical hand tool, hexagonal ferrule crimp to cable and hood. Crimp die (357-315-03) purchased separately. For overmold can.



d-sub field service kit 17RR-232K RS232 - assortment of connectors, backshells, contacts, & crimp tools - comparable to AMP model 606064-2



terminal & splice field service kit AI-177
 assortment of crimp-type terminals & splices, with hand-crimp tool



WPI - Salem Division
 23 Front Street, Salem, NJ 08079 U.S.A.
 phone (609) 935-7601
 fax (609) 935-0102 twx (510) 680-4750
 country code 1

order information

NOTE: (Use 356-200 handles for insertion/removal bits)

Contact	Barrel O.D./I.D.	Crimp Tool	Bushing (Location)	Crimp Setting for Wire AWG.								Insertion Tool Bit	Removal Tool Bit
				16	18	20	22	24	26	28	30		
17-763(S) 17-766(P)	.007/.045	357-100	357-300-02			#7 .038 ±.003	#6 .034 ±.003	#5 .030 ±.003				356-400-1 or 356-400-10 (Encapsulated) Connector— to 20 Ga. Wire)	356-400-5 356-400-6
17-763(S) 17-766(P)	.007/.045	357-2501											356-400-5 356-400-6
17-764(S)	.062/.045	Solder										356-400-1	356-400-5
17-765(P)	.062/.045	Solder										356-400-1	356-400-6
17-767(P)	.062/.045	Solder										356-400-1	356-400-6
17-1006P	.106/.067	consult factory		.058 ±.003	.053 ±.003							356-400-2	356-400-6
17-1006(S)	.106/.067												356-400-5
17-1198(P)	.040 Tall	Rt. Angle										356-400-4	356-400-6
17-1207(P)	.040 Tall	Rt. Angle										356-400-4	356-400-6
17-1208(S)	.040 Tall	Rt. Angle										356-400-4	356-400-5
17-1209(S)	.040 Tall	Rt. Angle										356-400-4	356-400-6
17-1263(S)	.062/.045	Solder										356-400-1	356-400-5
17-1308(S)	.077/.032	357-100	357-300-02					#7 .036 ±.002	#6 .032 ±.002	#5 .030 ±.002		356-400-1	356-400-5
17-1310(P)	.077/.032												
17-RRD1-FXX 17-RRD1-MXX		357-574				Applicator for contacts on reels— adj. crimp setting							356-271
			357-2500				.044 ±.011	.044 ±.001	.043 ±.001				
17-RRD2-MXX 17-RRD2-FXX		357-574				Applicator for contacts on reels— adj. crimp setting			.026 ±.001	.026 ±.001	.026 ±.001	.026 ±.001	356-271
			357-2500										
220-802(S)	.048/.031	357-100	357-300-01					.024 ±.002	.018 ±.002	.015 ±.002		356-400-11	356-400-14
220-P02(P)	.048/.031	357-100	357-300-08					.024 ±.002	.018 ±.002	.015 ±.002		356-400-11	356-400-15
220-803(S)	.050/.036	357-100	357-300-03					.024 ±.002	.020 ±.002	.015 ±.002		356-400-11	356-400-14
			357-104	357-304-03									
			357-110	357-310-03									
			358-400	358-340-05									
220-P03(P)	.050/.036	357-100	357-300-08					.024 ±.002	.020 ±.002	.015 ±.002		356-400-11	356-400-15
220-830	—	Solder	—									356-400-11	356-400-15
220-831	—	Solder	—									356-400-11	356-400-14
220-834	—	Solder	—									356-400-11	356-400-15
220-883	—	Solder	—									356-400-11	356-400-15
221-750(P) 221-760(S)	.033/.023 .033/.023	357-101 357-101	357-301-03 357-301-03					.021/.018 .021/.018	.018/.015 .018/.015	.015/.012 .015/.012		356-400-20 356-400-20	356-400-21 356-400-22

WPI - Salem Division
 23 Front Street, Salem, NJ 08079 U.S.A.
 phone (609) 935-7601
 fax (609) 935-0102 twx (510) 680-4750
 country code 1



cable assemblies

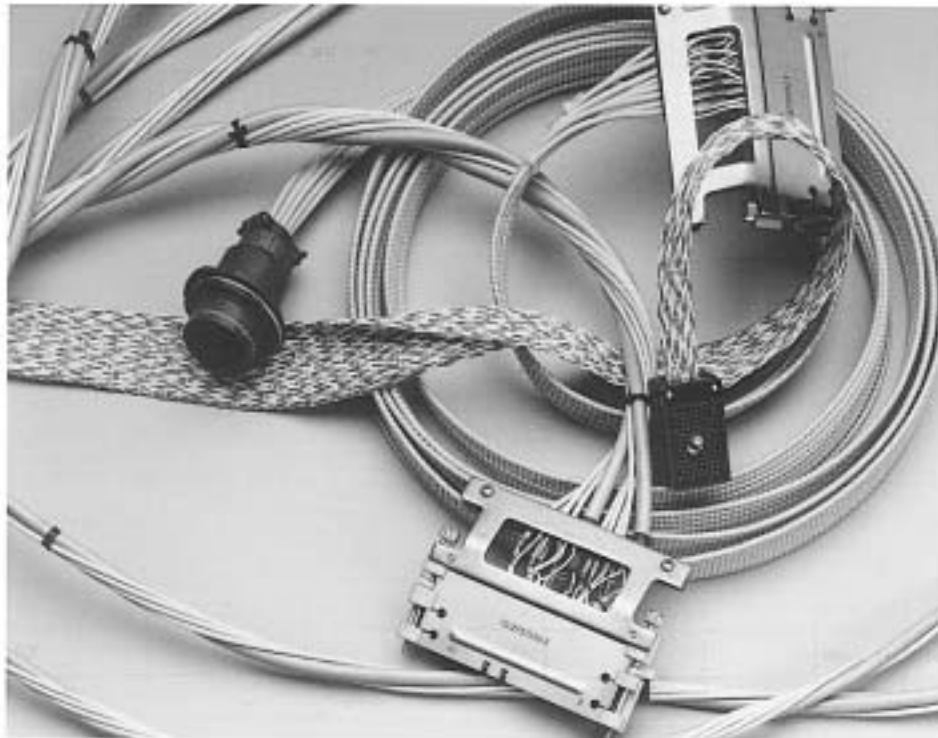

- **quality**
- **engineering / design**
- **resources**
- **manufacturing support**

WPI manufactures cable assemblies, wiring harnesses, and test probes for both military and commercial applications. Products range from simple test leads to highly complex molded and potted assemblies utilizing high reliability components that will survive the toughest environmental conditions.

WPI Cable Assembly Services has two locations (Salem, New Jersey and Sarasota, Florida), with two decades of manufacturing experience.

Please call or fax for a complete brochure, or for more specialized assistance!

WPI - Salem Division
23 Front Street, Salem, NJ 08079 U.S.A.
phone (609) 935-7601
fax (609) 935-0102 twx (510) 680-4750
country code 1





23 Front Street
Salem, NJ 08079
P: 856-935-7560
F: 856-935-0102
W: www.wpi-interconnect.com
E: info@wpi-interconnect.com

[17-20090](#)

[77-MIP-11](#)

[78-S11](#)

[78-S6](#)

[86-CP6](#)

EN - For pricing and availability in your local country please visit one of the below links:

DE - Informationen zu Preisen und Verfügbarkeit in Ihrem Land erhalten Sie über die unten aufgeführten Links:

FR - Pour connaître les tarifs et la disponibilité dans votre pays, cliquez sur l'un des liens suivants:

[146 103](#)

[26-4401-24S](#)

[86-3-24](#)

[77-MIP-8](#)

[17-1372](#)

[17-1588-06](#)

[17-310-01](#)

[143-015-01](#)

[17-10150](#)

[17-10250](#)

EN
This Datasheet is presented by
the manufacturer

DE
Dieses Datenblatt wird vom
Hersteller bereitgestellt

FR
Cette fiche technique est
présentée par le fabricant