

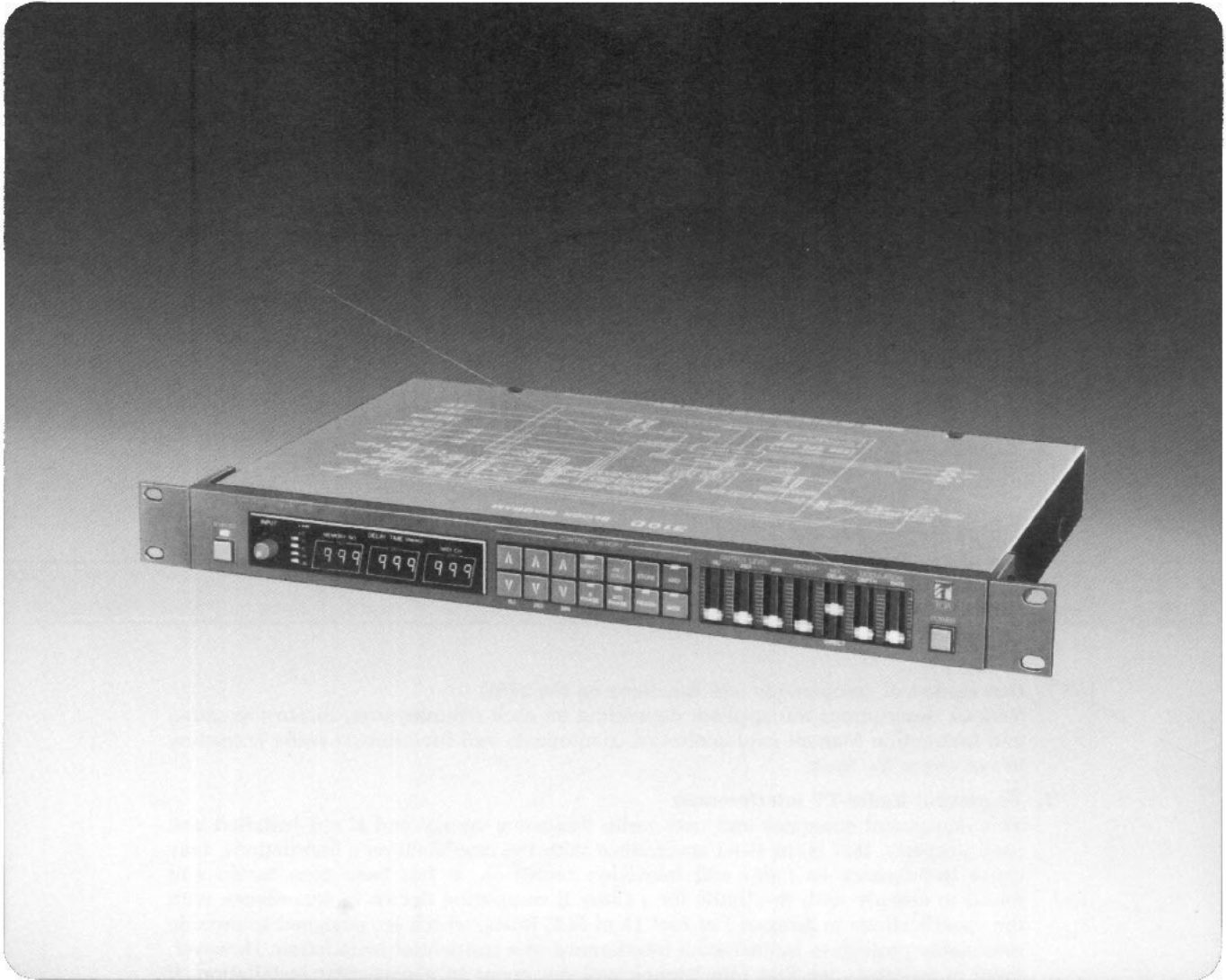

# MULTIPLE OUTPUT DIGITAL DELAY

Model 310D



---

---

## ● Contents

---

---

Precautions .....	1
General Description .....	2
Features .....	2
Front Panel.....	3
Rear Panel.....	4
Sample Sounds.....	5~6
Block Diagram .....	7
Specifications .....	7
Appearance.....	8

---

---

## ● Precautions

---

---

### **1. Description of components and functions on the 310D**

Various descriptions are applied, depending on each manufacturer. In our Operating and Instruction Manual explanation of components and functions is made according to our usage for them.

### **2. To prevent Radio-TV interferences**

This equipment generates and uses radio frequency energy and if not installed and used properly, that is, in strict accordance with the manufacturer's instructions, may cause interference to radio and television reception. It has been type tested and found to comply with the limits for a Class B computing device in accordance with the specifications in Subpart J of Part 15 of FCC Rules, which are designed to provide reasonable protection against such interference in a residential installation. However, there is no guarantee that interference will not occur in a particular installation. If this equipment does cause interference to radio or television reception, which can be determined by turning the equipment off and on, the user is encouraged to try to correct the interference by one or more of the following measures:

- ..... reorient the receiving antenna
- ..... relocate this equipment with respect to the receiver
- ..... move this equipment away from the receiver
- ..... plug this equipment into a different outlet so that this equipment and receiver are on different branch circuits

If necessary, the user should consult the dealer or an experienced radio/television technician for additional suggestions. The user may find the following booklet prepared by the Federal Communications Commission helpful:

"How to Identify and Resolve Radio-TV interference Problems"

This booklet is available from the US Government Printing Office, Washington, D.C., 20402, Stock No. 004-000-00345-4.

---

---

## ● General Description

---

---

The Toa 310D is a multiple output digital delay device that is one vertical rack size, mountable in a 19-inch EIA rack. Three discrete outputs with different delay times are obtainable from one input signal. With Toa special circuitry that mixes direct and delayed sounds and also reverses the phase of the delayed sounds, the 310D offers flanging, chorus, doubling or echo effects in stereo.

---

---

## ● Features

---

---

1. Three different time-delayed outputs can be obtained for one input signal.
2. Delay time can be set between 0 and 999 msec, enabling the faithful reproduction of subtle sound differences and wider chorus effects.
3. It is possible to mix the direct sound with three different time-delayed signals, and provide the mixed sound from stereo L and R outputs. Also, a wider stereo chorus effect can be obtained by activating the cross phase switch.
4. Each of the three different time-delayed sounds can be delivered to individual outputs.
5. A maximum of 32 overall settings of each of the three delay times and the on/off status of the CROSS PHASE, DELAY 2(C) PHASE, REGENERATION (FEEDBACK) and MODULATION switches can be stored.
6. The modulation IN and OUT jacks permit various timbres to be varied by external control.
7. Maximum chorus effect can be obtained by using two 310D units and connecting the "modulation in" terminal of the first unit to the "modulation out" terminal of next, and the "modulation out" of the first unit to the "modulation in" of the next.
8. Both RCA pin jacks and 1/4" phone jacks are provided for input and output, allowing easy connection of mixers for multi-track recorders.
9. Wide dynamic range provided by the combined method of logarithmic companding and 12-bit digital signal processing.
10. The 310D has a frequency response from 20Hz to 20kHz ( $\pm 3$ dB), enabled by a high sampling frequency.
11. MIDI In, Out and Thru are provided.
12. A built-in MIDI control function offers access to select specific programs from external MIDI equipment.

# Front Panel

## Delay time programming key (▲)

Pressing this key increases the programmed delay time in milliseconds. Pressing the key continuously increases the rate of change.

## Input level indicator LED's

### Input level control (INPUT)

This control sets the input signal level. To use, press and release the control to make it spring out. Adjust the level so the "+6dB" indicator LED lights intermittently. (The input signal begins to clip at +12dB.)

### Bypass switch (BYPASS)

When this switch is pressed, the LED comes on and the input signal is sent directly to the MIX output terminals, bypassing the internal circuit. If power is switched off, the input signal similarly bypasses the internal circuit and goes to the MIX outputs directly. (In either case, the input signal is not delivered to the SOLO output.)

## Memory Key (MEMORY)

When this key is pressed, the LED illuminates and the memory number is indicated on the delay time display. In order to obtain a specific memory location, press the ▲ or ▼ key until the desired memory number is displayed and then press the recall key.

In order to store delay times in a specific memory number, press the ▲ or ▼ key to select a specific memory number, and then press the store key continuously for 2 seconds. The memory key LED flashes to indicate completion of storage.

The current program can be retained even when power has been switched off. The last delay time and switch positions before power is switched off are stored and will be recalled automatically when the unit is again powered.

### Note

The 310D is employing lithium batteries for memory backup purposes. Although the battery life is longer than 5 years, the first set of batteries may have to be replaced earlier. Be sure to consult qualified personnel when replacing batteries.

## Recall Key (RECALL)

Pressing this key recalls the program stored in the specific memory number that is selected with the memory key.

## Store Key (STORE)

Stores three different delay times in a selected memory number, or changes MIDI channel number.

## MIDI Key (MIDI)

When this key is pressed, the associated LED illuminates and the MIDI channel number is indicated on the delay time display.

In order to change the MIDI channel number, press ▼ key or ▲ key to select the desired MIDI channel number, and then press the store key continuously for 2 seconds, the MIDI key LED will flash to indicate completion of changing.

## MIX output level control (OUTPUT LEVEL)

This control adjusts the output level of the delayed signals from 1 (L), 2 (C), and 3 (R) channels. The output level from the SOLO output is not affected by this control.

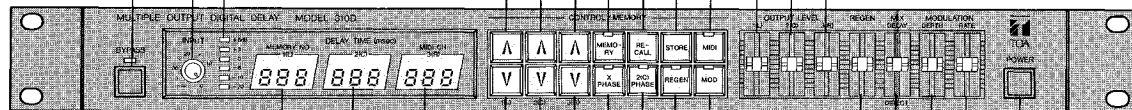

## Delay time display (DELAY TIME)

Delay times from 0 to 999 msec are available. 1(L), 2(C) and 3(R) correspond with the following MIX outputs, respectively.

- 1 (L): left
- 2 (C): center
- 3 (R): right

## Delay time programming key (▼)

Pressing this key reduces the delay time. Pressing the key continuously increases the rate of change.

## Cross Phase key (X PHASE)

When this key is pressed, the LED lights and the phase of the delayed signals of 1(L) and 3(R) is reversed. The reversed phase of 1(L) signal is sent to 3(R) and mixed, with that of 3(R) sent to 1(L).

### Note

Pressing the cross phase key when the delay time of both 1(L) and 3(R) is the same causes the signals to cancel each other, and as a result, no output is provided from 1(L) and 3(R). Pressing the key when only one (1) MIX output jack is used, or if the connected equipment is internally wired in parallel (even when both L and R jacks are used) will also result in no output.

## Regeneration (feedback) control (REGEN)

This control sets the number of regenerations of delay signal.

## Modulation key (MOD)

The LED lights and the delay time can be modulated when this key is pressed.

## Regeneration key (REGEN)

Pressing this key causes the LED to light, and the delay signal is regenerated.

## Delay 2(C) phase key (2(C) PHASE)

The LED lights and the phase of signal of 2(C) is reversed when this key is pressed.

## Power switch (POWER)

The power switch alternately turns AC power to the 310D "on" and "off".

## Modulation rate control (MODULATION RATE)

This control adjusts the oscillation frequency of the built-in low frequency oscillator. The speed of variation of the delay sound increases as the control is moved upward.

## Modulation depth control (MODULATION DEPTH)

This control adjusts the delay sound modulation ratio by the built-in low frequency oscillator. The modulation becomes deeper as the control is moved upward.

## Mixing level control (MIX DELAY/DIRECT)

This control adjusts the output level of the delayed signal. Delay signal to direct signal ration = 1:1 when the control is located in the center.

# Rear Panel

## Mix output jack (MIX OUT L, R)

The delayed signal and the direct signal are mixed into one signal, and are delivered to L and R outputs as a stereo signal. It is also possible to take out the signal as a monaural signal depending on the methods of connecting output jacks. (Refer to Table 1.) The output is unbalanced with a 600 ohms impedance.

**Table 1**

Number of jacks used	1	1	1	1	2	2	2	2	2	2	3	3	3	3	4
1/4" Phone jack L	○				○		○		○		○	○	○		○
1/4" Phone jack R		○			○		○		○		○	○	○		○
RCA jack L			○			○		○			○	○		○	○
RCA jack R				○		○		○	○			○	○	○	○
	L + R				Stereo		L only	R only	L + R		1/4" Phone Jack Stereo RCA jack L R		1/4" Phone Jack L R RCA jack Stereo		Stereo

○ stands for a jack plugged in.

## Inverted control voltage output jack (MODULATION OUT)

The control voltage of the built-in low frequency oscillator is provided from this jack as an output signal 180 degrees out of phase with the modulation signal applied to the unit. Its output signal level is adjustable (interlocked) with the modulation depth control.

## External control voltage input jack (MODULATION IN)

This jack is used when the delay time is to be modulated from external equipment. Voltages ranging from -10 volts to +10 volts may be fed to this jack. This jack mixes the input signal from the external equipment and the built-in low frequency oscillator, and modulates the delay time. By cross-connecting the inverted control voltage output to the external control voltage input using two 310D's, both will modulate each other. This feature will help produce added chorus or flanging effects.

## SOLO output jack (SOLO OUT 1.2.3)

The signal of each of 1(L), 2(C) and 3 (R) channels is individually provided from these output jacks. Since the signal is "pre-fader", the sound volume of this output is not affected by the mixing output level control. Rated output is +4dB, unbalanced with a 600 ohms impedance.

## In/out signal level selector switch (UNI GAIN)

Set the switch to -20dB or +4dB position depending on the input and output signal levels of the equipment connected. Both the input and the output signal levels are switched at the same time.

### CAUTION:

The selector should be switched when no input signal is present. Switching from the -20dB position to the +4dB position while an input signal is present may produce a momentary surge in output sound level, which may be harmful to other connected equipment. This is not a product failure; it occurs when the signal stored in memory is increased to the reference level of +4dB with a resulting increase in amplifier gain.

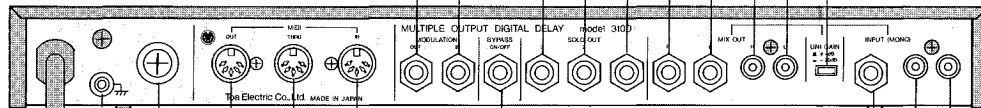

## Earth terminal

This terminal can be used to ground other devices to the 310D to reduce hum and shock hazard.

## AC fuse

### WARNING

To avoid possible equipment damage and/or personnel injury, the fuse should always be replaced with the same type and rating. Using improper fuses will also void the warranty. The 310D should always be disconnected from AC outlet prior to changing fuses. If fuse repeatedly fails, the unit should be referred to qualified personnel for repair.

## MIDI In (MIDI IN)

This connector accepts standard MIDI output signal from external equipment. A built-in MIDI control function is able to select a specific memory preprogrammed from the external MIDI equipment.

### Note:

Use of non-MIDI standard DIN cables, or of cables longer than 5m (16'5") may result in improper operation and data loss.

## MIDI Thru (MIDI THRU)

The MIDI signal from the MIDI input is sent unaltered to the MIDI Thru output.

## Bypass remote jack (BYPASS ON/OFF)

This jack is used for remote on/off operation of the internal bypass circuitry from a foot switch. When a foot switch is connected to this jack, the front-mounted bypass switch must be pressed "on". The foot switch will then operate the bypass circuitry. Under this state, pressing the front-mounted bypass switch cancels the bypass mode.

## Bypass Remote Jack And Foot Switch

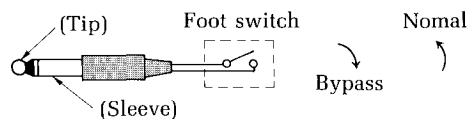

## MIDI Out (MIDI OUT)

The memory number selected by the recall key is transmitted to external MIDI equipment by means of the output MIDI signal.

Alternate type				
Momentary type	Type open-circuited when stamped			
	Type short-circuited when stamped			

# Sample Sounds

Following are the examples of various effects made by the 310D. In the memory No. 1 thru 11 these sample sounds are factory stored.

**1. ECHO 1** A stereo echo having relatively longer delay times as a whole.

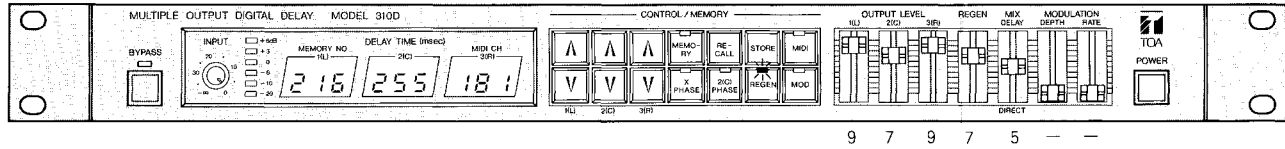

**2. ECHO 2** An echo having delay times much different from each other. Placing the Regeneration (feedback) switch in the off position produces gated echo-like sounds.

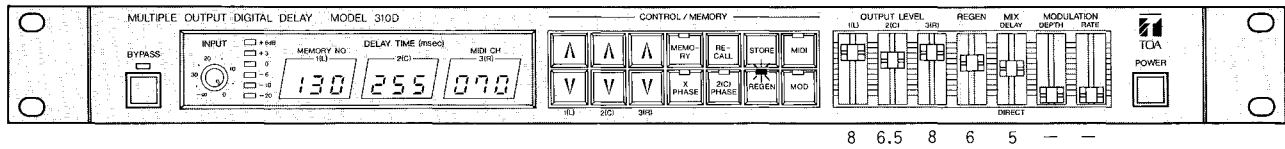

**3. PSEUDO-REVERB 1** A pseudo-reverb effect is obtainable by mixing three different delayed times, and combining the regeneration function.

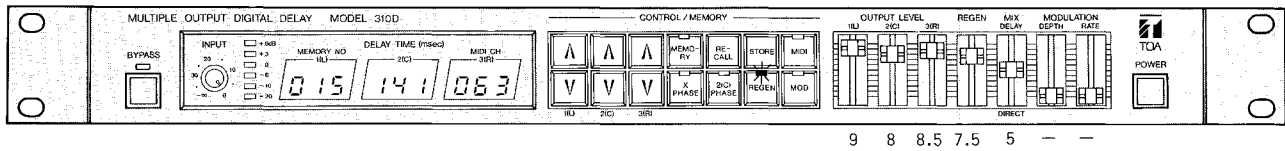

**4. PSEUDO-REVERB 2** This pseudo-reverb is similar to the pseudo-reverb effect 1, but a smoother reverb effect is provided by setting three different delayed times in relatively close proximity.

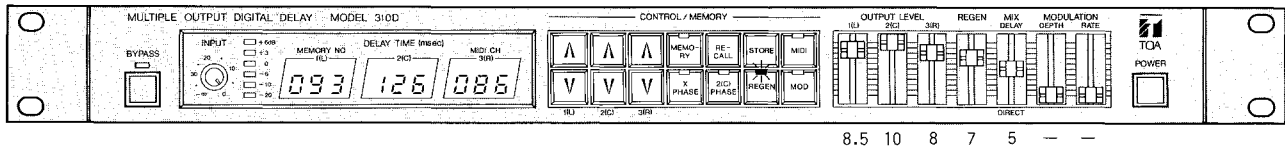

**5. FLANGING EFFECT** By mixing the delayed signal of 2(C) with the direct signal, a main flanging effect can be obtained, and a side flanging effect results from a cross-phased 1(L) and 3(R). The delay time of 2(C) and the 2(C) phase switch both play a main role in determining the timbre. Both 1(L) and 3(R) give a sense of sound "spreading". Set the cross phase switch to OFF for monoaural output.

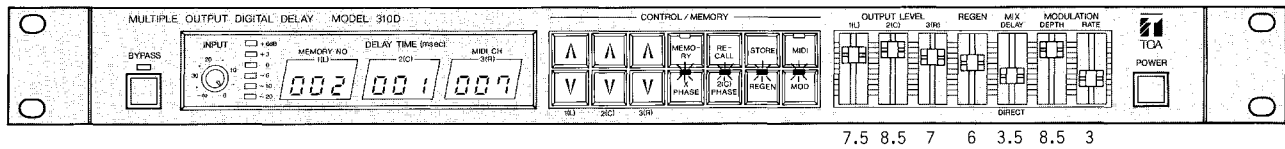

# Sample Sounds

## 6. CHORUS EFFECT

Mixing the delayed signal of 2(C) with the direct signal provides a main chorus effect, with a side chorus effect obtained by delay times of 1(L) and 3(R). The sense of sound spreading may be controlled by the difference in delay time between 1(L) and 3(R) and the cross phase switch as well. Reducing the difference in delay time between 1(L) and 3(R) by setting the cross phase switch to "on" results in a flanging effect.

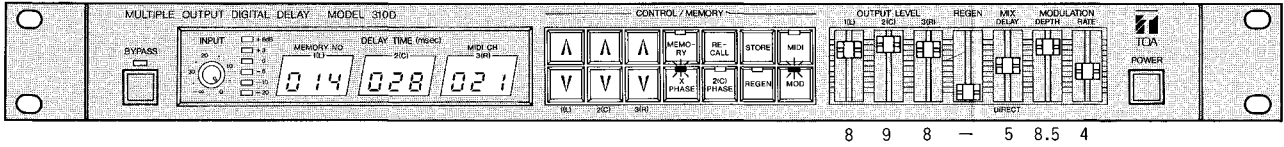

## 7. DOUBLING 1

With a strong attack sound, a doubling sound is produced.

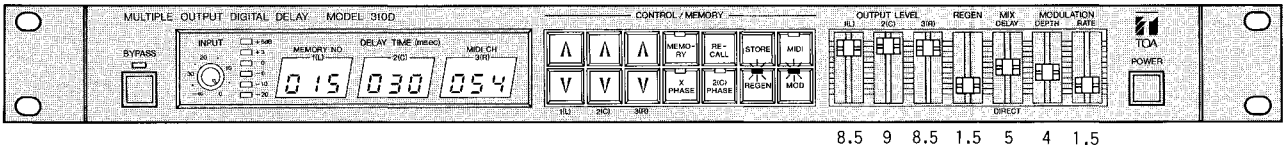

## 8. DOUBLING 2

This is another doubling effect for a vocal, with the vocal sound heard expanding to the right and left with a feeling of depth.

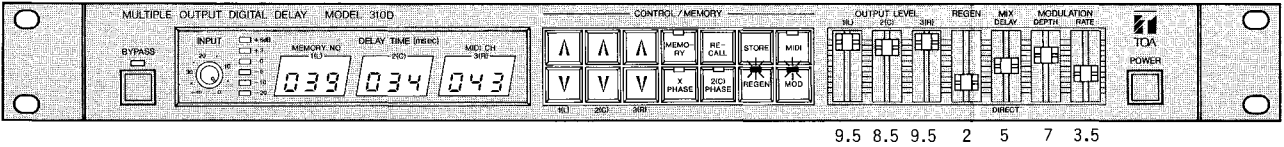

## 9. FLANGING CHORUS 1

By mixing the delayed signal of 2(C) with the direct signal, a main flanging effect can be obtained by 1(L) and 3(C). This setting allows clearer sounds to be provided over a central area than with the chorus effect.

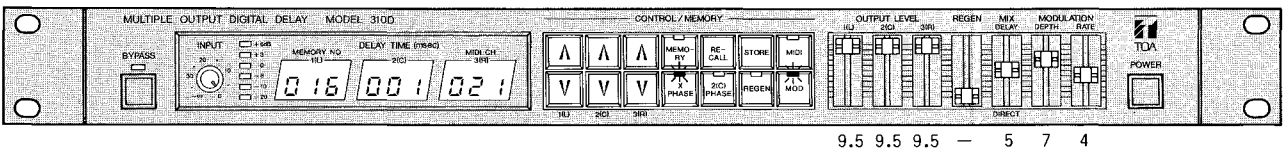

## 10. FLANGING CHORUS 2

Mixing the delayed signal of 2(C) with the direct signal, and delay times of 1(L) and 3(R), result in a chorus effect and a side flanging effect, respectively.

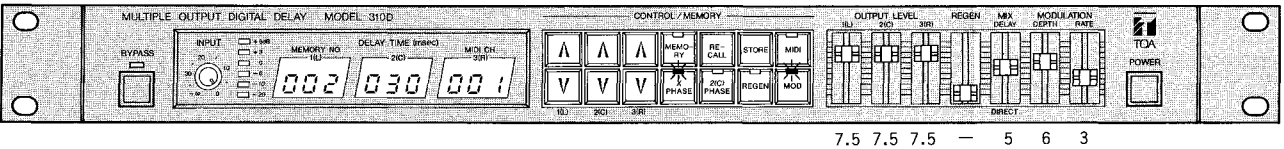

## 11. SHORT DELAY

This is a relatively short echo that can be used for backing of a single note produced by a guitar, etc.

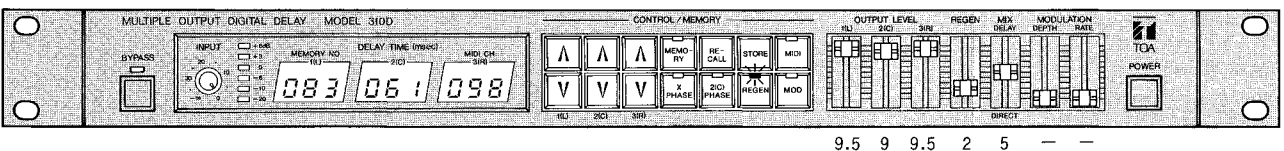

## Block Diagrams

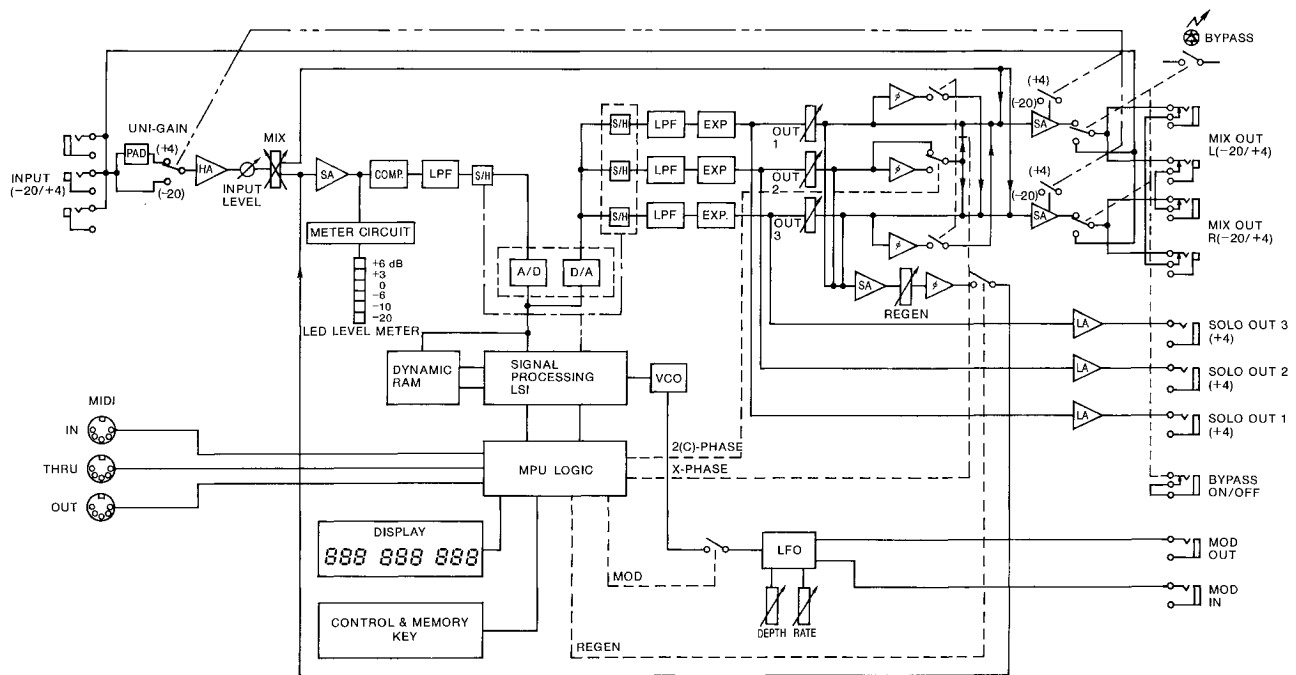

## Specifications

### Input

Nominal level	-20dB*/+4dB* switchable
MAX. before clip	0dB*/+24dB*
Impedance	50kΩ unbalanced

### Output

<b>MIX OUT</b>	
Nominal level	-20dB*/+4dB* Interlocked with input
MAX. before clip	-9dB*/+15dB*
Impedance	600Ω unbalanced
<b>SOLO OUT</b>	
Nominal level	+4dB*
MAX. before clip	+15dB*
Impedance	600Ω unbalanced

### Frequency response

20Hz~20kHz	±3dB
------------	------

### Total Harmonic Distortion

Direct Signal	0.01% +4dB* at 1kHz
Delayed Signal	0.3% +4dB* at 1kHz (Delay time 999msec)

### Hum and Noise (INPUT : SHORT CIRCUIT, OUTPUT : OPEN, IHF-A)

<b>MIX OUT</b>	
Output Level Control	1~3 maximum
Input Level Control maximum	—88dB* at +4dB position
	—110dB* at —20dB position
<b>SOLO OUT</b>	
Input Level Control maximum	-92dB*

### Delay Time

0~999msec (1msec step)
------------------------

### Modulation Output

Voltage Range	0~5V (Triangle Wave)
Impedance	1kΩ

### Modulation Input

Voltage Range	-10~+10V
Impedance	50kΩ

### Level Indicator

—20dB~+6dB	6-points
------------	----------

### Memory

Delay Time	1(L), 2(C), 3(R)
On/Off state of	X-PHASE, 2(C) PHASE, REGEN, and MOD switch
Presets	32 patterns of the above delay times and switches

### MIDI

Recognize MIDI Messages	Program Change, OMNI On/Off
Transmit MIDI Message	Program Change, OMNI On/Off

### Power Consumption

15W
-----

### Dimensions (WxDxH)

483×297×51mm (19×11.7×2Inch)
------------------------------

### Weight

4.2kg (9.3lbs)
----------------

\*0dB is referenced to 0.775V RMS  
Specifications are subject to change without notice.





