

Portable MiniDisc Recorder

Operating instructions



MZ-R55

WARNING

To prevent fire or shock hazard, do not expose the unit to rain or moisture.

To avoid electrical shock, do not open the cabinet. Refer servicing to qualified personnel only.

Caution

The use of optical instruments with this product will increase eye hazard.

Information

For Customers in the USA

This equipment has been tested and found to comply with the limits for a Class B digital device, pursuant to Part 15 of the FCC Rules. These limits are designed to provide reasonable protection against harmful interference in a residential installation. This equipment generates, uses, and can radiate radio frequency energy and, if not installed and used in accordance with the instructions, may cause harmful interference to radio communications. However, there is no guarantee that interference will not occur in a particular installation. If this equipment does cause harmful interference to radio or television reception, which can be determined by turning the equipment off and on, the user is encouraged to try to correct the interference by one or more of the following measures:

- Reorient or relocate the receiving antenna.
- Increase the separation between the equipment and receiver.
- Connect the equipment into an outlet on a circuit different from that to which the receiver is connected.
- Consult the dealer or an experienced radio/TV technician for help.

You are cautioned that any changes or modifications not expressly approved in this manual could void your authority to operate this equipment.

The built-in battery should be replaced by qualified personnel only.

For Customers in Australia

If the supply cord of the AC power adaptor is damaged, the AC power adaptor must be returned to the manufacturer or his agent for the cord to be replaced.

For the customers in the USA

DISPOSAL OF NICKEL METAL HYDRIDE BATTERY

NICKEL METAL HYDRIDE BATTERY. DISPOSE OF PROPERLY.

You can return your unwanted nickel metal hydride batteries to your nearest Sony Service Center.

Note: In some areas the disposal of nickel metal hydride batteries in household or business trash may be prohibited.

For the Sony Service Center nearest you call 1-800-222-SONY (United States only)

Caution: Do not handle damaged or leaking nickel metal hydride battery.

IN NO EVENT SHALL SELLER BE LIABLE FOR ANY DIRECT, INCIDENTAL OR CONSEQUENTIAL DAMAGES OF ANY NATURE, OR LOSSES OR EXPENSES RESULTING FROM ANY DEFECTIVE PRODUCT OR THE USE OF ANY PRODUCT.

Owner's Record

The serial number is located at the rear of the disc compartment lid and the model number is located at the top and bottom. Record the serial number in the space provided below. Refer to them whenever you call upon your Sony dealer regarding this product.

Model No. MZ-R55

Serial No. _____

"MD WALKMAN" is a trademark of Sony Corporation.

Welcome!

Welcome to the world of the MiniDisc!
Here are some of the capabilities and features you'll discover with the new MiniDisc Recorder.

- Recording MD Walkman in an ultra-compact body — Almost as small as a playback-only MD Walkman; easy to carry in your pocket or bag.
 - Low power consumption design — Runs on a single "chewing gum" type rechargeable battery.
 - Simultaneous labeling feature — No more waiting for the recording to end; you can label tracks and discs while the MD is being recorded.
 - 9-letter, backlit LCD remote control with editing capabilities — You can now label tracks and discs, change track sequence, etc., with the easy-to-operate stick remote control.
 - Shock-resistant memory — Offsets up to 40 seconds of optical read errors.
 - High-fidelity recording — Low-noise, low-distortion, high-fidelity recording through the optical digital input jack.
 - Digital synchro-recording — When recording from a digital equipment with optical output, the recorder automatically starts and pauses recording in sync with operation on the digital source.
 - Sampling rate converter — This unit enables you to record programs from digital equipment using other sampling rates, such as a BS tuner or DAT deck.
 - Digital AGC (Auto Gain Control) — Automatic recording level adjustment without sacrificing superb digital sound.
 - Long-time recording with monaural sound — You can record up to 148 minutes on a disc using monaural recording.
 - Date and time stamp function — The built-in clock automatically records the date and time whenever you make a recording.
- Title function — You can see disc and track titles in the display while you are playing/recording an MD.

Table of contents

Recording an MD right away!	6
--	----------

Playing an MD right away!	8
--	----------

Various ways of recording	10
--	-----------

Two ways of connecting to a sound source	10
Recording with digital input (optical cable required)	11
To start/stop recording in sync with the source player (Synchro-recording)	11
Recording from a microphone	12
Recording in monaural for double the normal recording time	13
Adjusting the recording level manually (Manual recording)	13
Checking the remaining time or the recording position	14
On the recorder	14
On the remote control	15
Setting the clock to stamp the recorded time	16

Various ways of playback	17
---------------------------------------	-----------

Playing tracks repeatedly	17
Emphasizing bass (DIGITAL MEGA BASS)	18
Protecting your hearing (AVLS)	18
Checking the remaining time or the playing position	19
On the recorder	19
On the remote control	19
Locking the controls (HOLD)	20
Connecting to a stereo system	20

Editing recorded tracks 21

Erasing tracks	21
To erase a track	21
To erase the whole disc	21
Adding a track mark	22
Erasing a track mark	22
Moving recorded tracks	23
On the recorder	23
On the remote control	23
Labeling recordings	24
On the recorder	24
On the remote control	25

Power sources 27

Charging the nickel metal hydride rechargeable battery	27
Using dry batteries	28

Additional information 29

Precautions	29
Troubleshooting	31
System limitations	33
Messages	34
Specifications	36
What is an MD?	37
Looking at the controls	39

Recording an MD right away!

The sound will be sent from the connected equipment as analog signal but will be recorded digitally on the disc. To record from a digital source, see “Recording with digital input” (page 11).

1 Make connections. (Connect securely.)

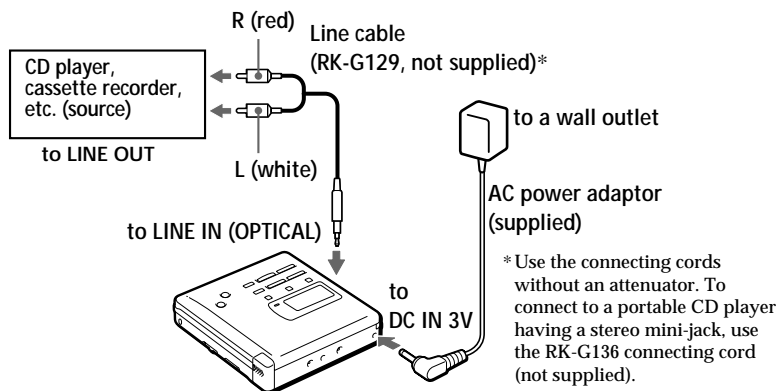

2 Insert a recordable MD.

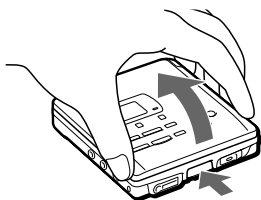

① Press OPEN and open the lid.

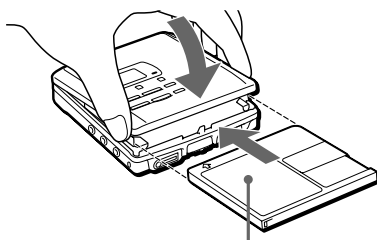

② Insert a recordable MD with the label side facing up, and press the lid down to close.

3 Record an MD.

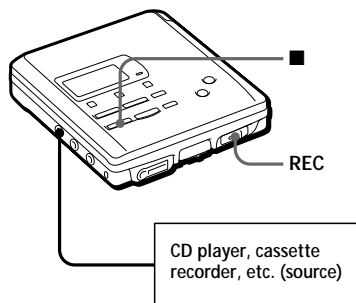

- 1 Press and slide REC to the right .
"REC" lights up and recording starts.
- 2 Play the CD or tape you want to record.

To stop recording, press ■.
"Data Save" or "Toc Edit" flashes while data of the recording (the track's start and end points, etc.) is being recorded. Do not move or jog the recorder or disconnect the power source while the indication is flashing in the display.

To	Press
Pause	¹⁾ Press again to resume recording.
Record from the end of the previous recording	END SEARCH and slide REC.
Record partway through the previous recording.	▶, ▶▶ or ◀◀ to find the start point of recording and press ■ to stop. Then slide REC.
Remove the MD.	■ and open the lid. ²⁾

- ¹⁾ A track mark is added at the point where you press ||; thus the remainder of the track will be counted as a new track.
- ²⁾ Once you open the lid, the point to start recording will change to the beginning of the first track. Check the point to start recording on the display.

If the recording does not start

- Make sure the recorder is not locked (page 20).
- Make sure the MD is not record-protected (page 30).
- Premastered MDs cannot be recorded over.

Note

If the power supply is disrupted (i.e. the battery is removed or becomes exhausted or the AC power adaptor is disconnected) when the recorder is operating, the lid will not open until the power is restored.



- The level of the recorded sound is adjusted automatically.
- You can monitor the sound during recording. Connect the supplied headphones with remote control to ◻/REMOTE and adjust the volume by pressing VOLUME +/- (VOL +/- on the remote control). This does not affect the recording level.

Playing an MD right away!

To use the recorder on a rechargeable battery or dry batteries, see “Power Sources” (pages 27, 28).

1 Make connections. (Connect securely.)

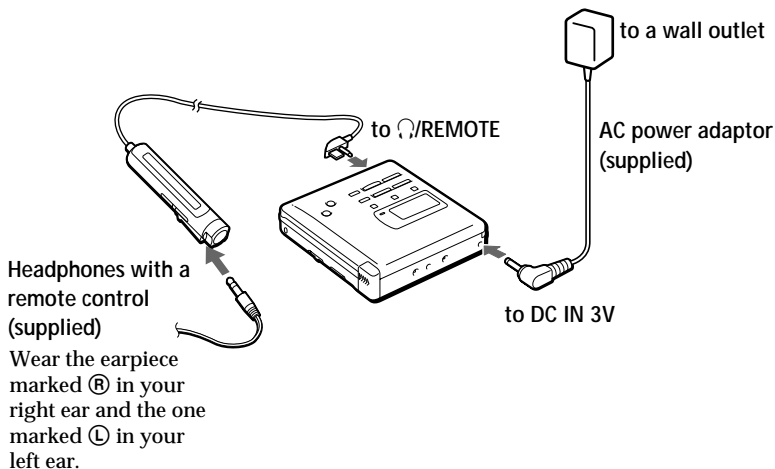

2 Insert an MD.

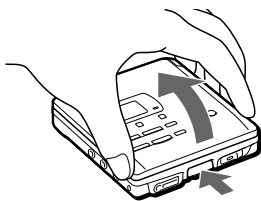

① Press OPEN and open the lid.

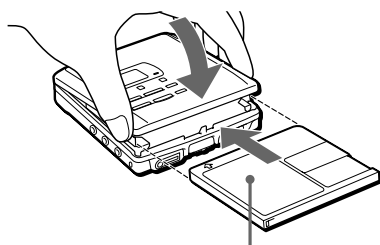

② Insert an MD with the label side facing up, and press the lid down to close.

3 Play an MD.

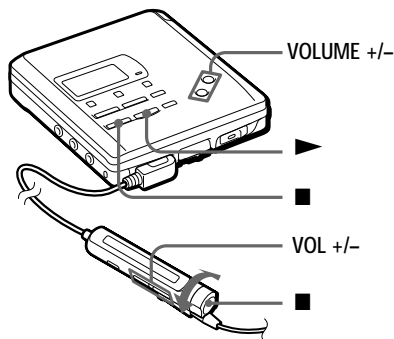

- ① Press **▶** (Turn the control to **▶•▶▶** on the remote control). A short beep sounds in the headphones when you operate on the remote control.
- ② Press **VOLUME (VOL on the remote control) +/-** to adjust the volume. The volume will be shown in the display.

To stop play, press **■**.
A long beep sounds in the headphones when you operate on the remote control.

To	Press (Beeps in the headphones)
Pause	 (Continuous short beeps) Press again to resume play.
Find the beginning of the current track	◀◀ once (Turn the control to ◀◀ on the remote control) (Three short beeps)
Find the beginning of the next track	▶▶ once (Turn the control to ▶•▶▶ on the remote control) (Two short beeps)
Go backwards while playing ¹⁾	keep pressing ◀◀ (Turn and hold the control to ◀◀ on the remote control)
Go forward while playing ¹⁾	keep pressing ▶▶ (Turn and hold the control to ▶•▶▶ on the remote control)
Remove the MD	■ and open the lid. ²⁾

¹⁾ To go backward or forward quickly without listening, press **||** and keep pressing **◀◀** or **▶▶**.

²⁾ Once you open the lid, the point to start play will change to the beginning of the first track.

If the play does not start

Make sure the recorder is not locked (page 20).

When using optional headphones

Use only headphones with stereo mini plugs. You cannot use headphones with micro plugs.



Playback will switch automatically between stereo and monaural according to the sound source.

Notes

- The sound may skip during playback when the recorder is exposed to continuous vibration, such as while jogging.
- If the power supply is disrupted (i.e. the battery is removed or becomes exhausted or the AC power adaptor is disconnected) when the recorder is operating, the lid may not open until the power is restored.

► Various ways of recording

Two ways of connecting to a sound source

The input jack of this recorder works as both digital and analog input jacks. Connect the recorder to a CD player or a cassette recorder using either digital input or analog input. To record, see “Recording with digital input” (page 11) to record using digital input, and “Recording an MD right away!” (page 6) to record using analog input.

Difference between digital and analog inputs

Difference	Digital input	Analog (line) input
Connectable source	Equipment with an optical digital output jack	Equipment with an analog (line) output jack
Usable cord	Digital cable (with an optical or an optical-mini plug)	Line cable (with 2 phono plugs or a stereo-mini plug)
Signal from the source	Digital	Analog Even when a digital source (such as a CD) is connected, the signal sent to the recorder is analog.
Recorded track numbers	Marked (copied) automatically • at the same positions as the source. • when the recorder is paused while recording. You can erase unnecessary marks after recording (“Erasing a track mark”, page 22).	Marked automatically • after more than 2 seconds of blank or low-level segment. • when the recorder is paused while recording. You can erase unnecessary marks after recording (“Erasing a track mark”, page 22).
Recorded sound level	Same as the source	Adjusted automatically. Can also be adjusted manually (“Adjusting the recording level manually”, page 13).

Note

Track marks may be copied incorrectly :

- when you record from some CD players or multi disc players using digital input.
- when the source is in shuffle or program play mode while recording using digital input. In this case, play the source in normal play mode.
- when recording BS or CS programs through digital input.

Recording with digital input (optical cable required)

Connect to a digital source using an optical cable (POC-5B or POC-5AB, not supplied) to make digital recordings. Digital recording is possible even from digital equipment with different sampling rates, such as a DAT deck or a BS tuner, using the built-in sampling rate converter.

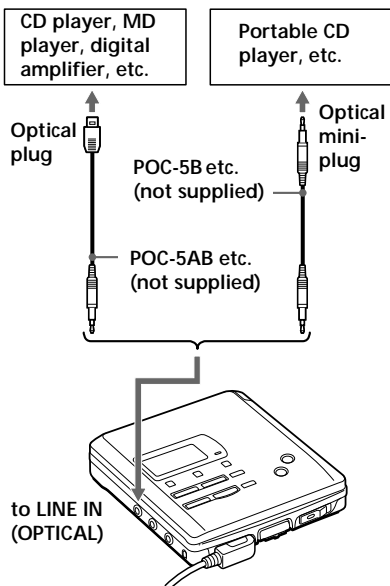

- 1 Insert a recordable MD and start recording.
For recording operations, see "Recording an MD right away!" (page 6). To record from a portable CD player, set the CD player to pause and then start recording.

LINE IN (OPTICAL) jack is for both digital and analog input

The recorder automatically recognizes the type of line cable and switches to digital or analog input.

Notes

- You can make a digital recording only from an optical type output.
 - When recording from a portable CD player, play it on AC power and disable the anti-skip function (such as ESP*).
 - Digital output may be disabled on some portable CD players when the player is not run on AC power.
- * Electronic Shock Protection

To start/stop recording in sync with the source player (Synchro-recording)

You can easily make digital recordings of a digital source on an MD. Before synchro-recording, make connections to the digital source with a digital cable, and insert a recordable MD.

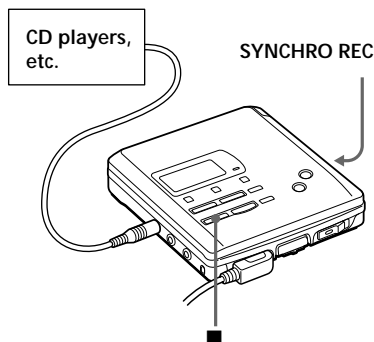

- 1 Slide SYNCHRO REC to ON. "SYNC" appears in the display.

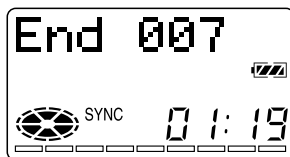

- 2 Press and slide REC to the right. The recorder stands by for recording.
- 3 Play the source sound. The recorder starts recording when it receives the playing sound.

continued

To stop recording, press ■.



- You cannot pause manually during synchro-recording.
- When there is no sound from the player for more than 3 seconds during synchro-recording, the recorder goes into the standby mode automatically. When the sound comes from the player again, the recorder resumes synchro-recording. If the recorder is kept in the standby mode for 5 minutes or longer, the recorder stops automatically.

Notes

- Do not switch SYNCHRO REC after step 2. Recording may not be done properly.
- When recording in monaural, follow steps 1 and 2 of "Recording in monaural for double the normal recording time" (page 13) before synchro-recording.
- Even when there is no recorded sound on the sound source, there may be cases when recording does not pause automatically during synchro-recording due to the noise level emitted from the sound source.

Recording from a microphone

Connect a stereo microphone (ECM-717, ECM-MS907, ECM-MS957, etc.; not supplied) to the MIC (PLUG IN POWER) jack.

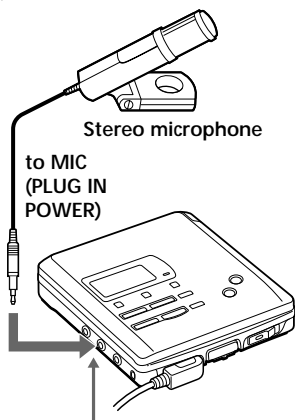

MIC SENS (at the bottom)

- 1** Select the sensitivity with MIC SENS (at the bottom of the recorder). Usually, set it to HIGH. When recording loud sounds such as a live concert, set it to LOW.
- 2** Insert a recordable MD and start recording. Press and slide REC to the right. "REC" lights up and recording starts. For other operations, see "Recording an MD right away!" (page 6).

Notes

- You cannot record through the microphone while an optical cable is connected to the LINE IN (OPTICAL) jack. The recorder automatically switches input in the following order; optical input, microphone input, and analog input.
- The microphone may pick up the operating sound of the recorder itself. Use the microphone away from the recorder in such cases.

Recording in monaural for double the normal recording time

For longer recordings, choose to record in monaural. The recording time becomes double the normal.

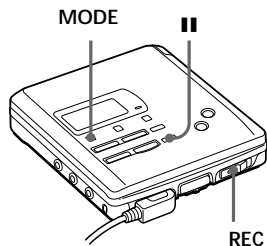

- 1 While pressing **||**, press and slide REC to the right.
The recorder stands by for recording.
- 2 Press MODE.
"Mono REC" appears in the display, and the recorder switches to monaural recording.
Press MODE again to record in stereo.
- 3 Press **||** again to start recording.
- 4 Play the sound source.

To stop recording, press ■.

The recorder switches back to stereo recording when you record the next time.

Notes

- If you record a stereo source in monaural, the sounds from left and right will be mixed.
- You cannot record in monaural if SYNCHRO REC is slid to ON.
- The MDs recorded in monaural can be played back only with an MD player/recorder that has the monaural playing function.
- Sound recorded through digital input can be monitored in stereo through headphones, etc.

Adjusting the recording level manually (Manual recording)

When you record with an analog input, the sound level is adjusted automatically. If necessary, you can set the level manually.

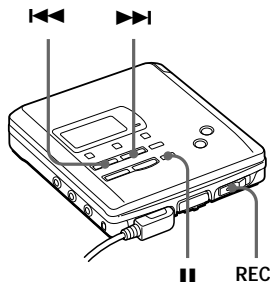

- 1 While holding down **||**, press and hold REC to the right for more than 2 seconds.
"ManualREC" appears and the recorder stands by for recording.
To return to the automatic control, while the recorder is in standby mode, press and hold REC to the right again for more than 2 seconds.

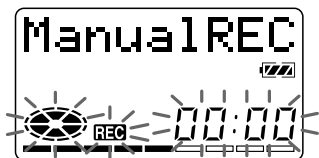

- 2 Play the source.

continued

- 3 While observing the level meter in the display, adjust the recording level by pressing ►► (+) or ◄◄ (-). Set the level so that it hits the -12dB at maximum input level.

Volume decreases ← increases →



Note

Adjust the recording level while the recorder is in standby mode. You cannot adjust it while recording.

- 4 Press ■ again to start recording.

To stop recording, press ■.

The recording level control is switched back to automatic control when you record the next time.



When you record with microphone input, select the sensitivity with MIC SENS (page 12).

Checking the remaining time or the recording position

You can check the remaining time, track number, etc. when recording or during stop.

On the recorder

DISPLAY REC indicator

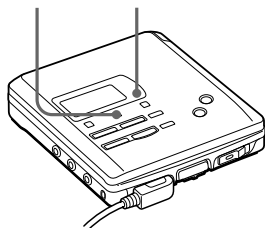

- 1 Press DISPLAY while recording or in stop mode. Each time you press the button, the display changes as follows.

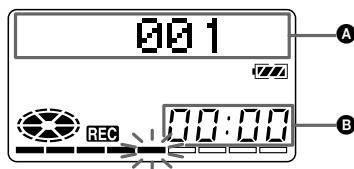

While recording

A	B
Track number	Elapsed time
Track number	Remaining time for recording
Current date ¹⁾	Current time ¹⁾

¹⁾Appears only when the clock is set.

In stop mode

A	B
Track number	Elapsed time
Track name ¹⁾	Remaining time for recording
Disc name ¹⁾	Remaining time after the current location
Current date ²⁾	Current time ²⁾

¹⁾Appears only if the track has been labeled.

²⁾Appears only when the clock is set.

On the remote control

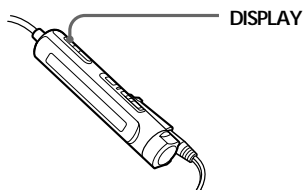

- 1 Press DISPLAY while recording or in stop mode. Each time you press the button, the display changes as follows.

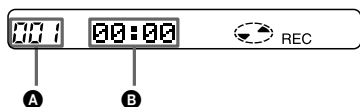

While recording

A	B
Track number	Elapsed time
Track number	Remaining time for recording
—	Current time ¹⁾

¹⁾Appears only when the clock is set.

In stop mode

A	B
Track number	Elapsed time
Track number	Track name ¹⁾
Number of tracks in the disc	Disc name ¹⁾
—	Current time ²⁾

¹⁾Appears only if the track has been labeled.

²⁾Appears only when the clock is set.

To know the recording condition

The REC indicator lights up or flashes according to the recording condition.

Recording condition	REC indicator
While recording	lights up flashes according to the loudness of the source while recording with a microphone (voice mirror)
Recording standby	flashes
Less than 3 minutes' recording time available	flashes slowly
A track mark has been added	goes off momentarily



If you want to check the playing position or track name while playing, see page 19.

Setting the clock to stamp the recorded time

To stamp the date and time on the MD when you record, you first need to set the clock.

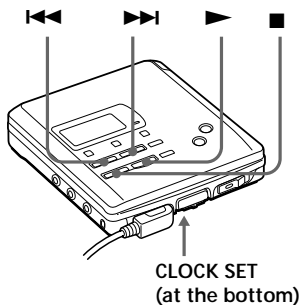

- 1 Connect the power source.
Use the supplied AC power adaptor.
- 2 Press CLOCK SET at the bottom of the recorder.
Use a pointed object.
The digits of the year flash.

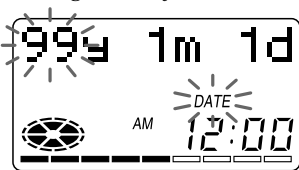

- 3 Change the current year by pressing **◀◀** or **▶▶**.
To change the digits rapidly, keep pressing **◀◀** or **▶▶**.
- 4 Press **▶** to enter the year.
The digit of the month flashes.
- 5 Repeat steps 3 and 4 to enter the current month, date, hour, and minute.
When you press **▶** to enter the minute, the clock starts operating.

If you make a mistake while setting the clock

Press **■**, and set the clock again from step 2. You can skip a step by pressing **▶**.

To display the current time

When the recorder is not operating or while recording, press DISPLAY repeatedly until the current time appears in the display.

To display the time in the 24-hour system

While setting the clock, press DISPLAY. To display the time in the 12-hour system, press DISPLAY again.

Charging the built-in battery for the clock

When you use the recorder for the first time or after a long period of disuse, charge the built-in battery. After setting the clock, leave the recorder connected to the AC power for about 2 hours to charge the built-in battery. Once charged, the built-in battery should last about a month without connecting to any of the power sources. The recorder will automatically charge the built-in battery while connected to AC power, dry batteries or a rechargeable battery.

► Various ways of playback

Playing tracks repeatedly

You can play tracks repeatedly in three ways — all repeat, single repeat, and shuffle repeat.

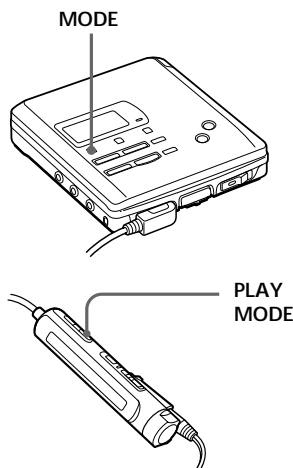

- 1 Press MODE (PLAY MODE on the remote control) while the recorder is playing an MD. Each time you press the button, the play mode indication changes as follows.

Ex; Display on the main unit

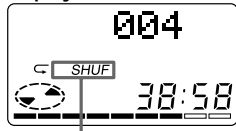

Play mode indication

Indication	Play mode
none (normal play)	All the tracks are played once.
"◀" (all repeat)	All the tracks are played repeatedly.
"◀ 1" (single repeat)	A single track is played repeatedly.
"◀ SHUF" (shuffle repeat)	All the tracks are played repeatedly in random order.

Emphasizing bass (DIGITAL MEGA BASS)

Mega Bass function intensifies low frequency sound for richer quality audio reproduction. It affects only the sound from the headphones.

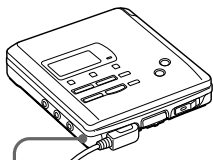



DIGITAL MEGA BASS

- 1 Press DIGITAL MEGA BASS. Each time you press DIGITAL MEGA BASS, the Mega Bass indication changes as follows.

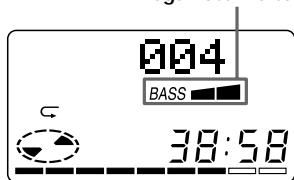
Mega Bass indication



Indication	Play mode
none	Normal play
"BASS  "	Mega Bass (moderate effect)
"BASS  "	Mega Bass (strong effect)

Notes

- If the sound becomes distorted when emphasizing bass, turn down the volume.
- Mega Bass function does not affect the sound being recorded.
- Mega Bass does not function when a line cable is connected to the LINE OUT jack on the recorder.

Protecting your hearing (AVLS)

The AVLS (Automatic Volume Limiter System) function keeps down the maximum volume to protect your ears.

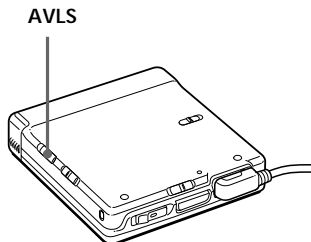

- 1 Set AVLS at the bottom of the recorder to LIMIT. When you try to turn the volume too high, "AVLS" appears in the display. The volume is kept to a moderate level.

Checking the remaining time or the playing position

You can check the track name, disc name, etc. during playback.

On the recorder

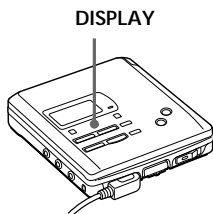

- 1 Press DISPLAY while playing. Each time you press DISPLAY, the display changes as follows.

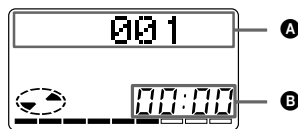

A	B
Track number	Elapsed time
Track name ¹⁾	Remaining time of the current track
Disc name ¹⁾	Remaining time after the current location
Recorded date ²⁾	Recorded time ²⁾

¹⁾Appears only if the track has been labeled.

²⁾Appears only when the clock is set.

On the remote control

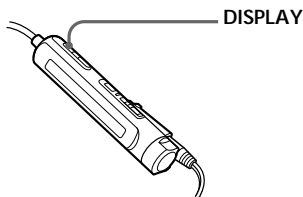

- 1 Press DISPLAY while playing. Each time you press DISPLAY, the display changes as follows.

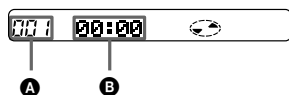

A	B
Track number	Elapsed time
Track number	Track name ¹⁾
The number of tracks in the disc	Disc name ¹⁾
—	Recorded time ²⁾

¹⁾Appears only if the track has been labeled.

²⁾Appears only when the clock is set.



If you want to check the remaining time or the recording position while recording or in stop mode, see page 14.

Locking the controls (HOLD)

To prevent the buttons from being accidentally operated when you carry the recorder, use this function.

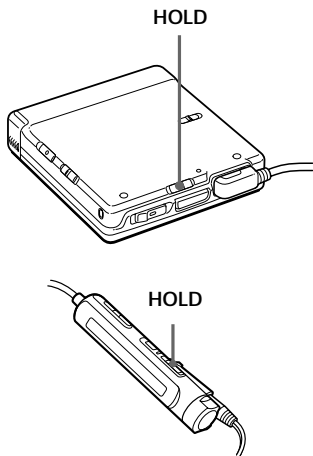

- 1 Slide HOLD in the direction of the 

On the recorder, slide HOLD to lock the controls of the recorder. On the remote control, slide HOLD to lock the controls of the remote control.

Slide HOLD in the opposite direction of the arrow to unlock the controls.

Connecting to a stereo system

Connect the LINE OUT jack of the recorder to the LINE IN jacks of an amplifier or a tape player with a line cable (RK-G129 or RK-G136, not supplied). The output is analog. The recorder plays the MD digitally and sends analog signals to the connected equipment.

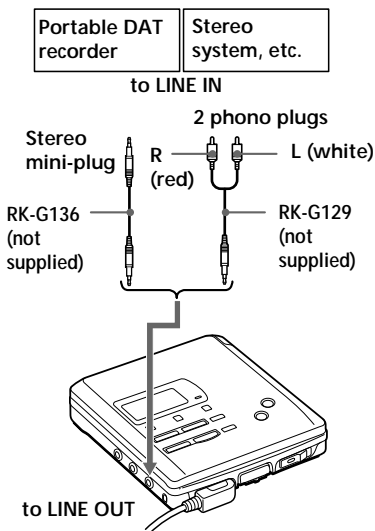

Note

The Mega Bass does not function or will be cancelled when the LINE OUT jack is connected with a line cable.

▶ Editing recorded tracks

You can edit your recordings by adding/erasing track marks or labeling tracks and MDs. Premastered MDs cannot be edited.

Notes on editing

- Do not move or jog the recorder while "Toc Edit"* is flashing in the display.
- You cannot edit tracks on an MD that is record-protected. Before editing tracks, close the tab on the side of the MD.

*TOC = Table of Contents

Erasing tracks

To erase a track

Note that once a recording has been erased, you cannot retrieve it. Make sure of the track you are erasing.

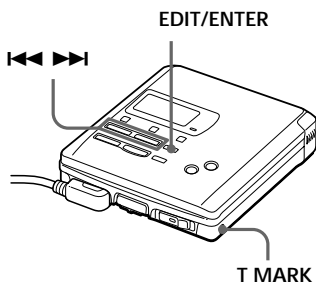

- 1** Press EDIT/ENTER while playing the track you want to erase.
" 🎵 : Name" flashes in the display, and the recorder plays the selected track repeatedly.
- 2** Press ◀◀ or ▶▶ repeatedly until " 🎵 : Erase" flashes in the display.
- 3** Press EDIT/ENTER again.
"Erase OK?" and "Push ENTER" appear alternately in the display.
To cancel erasing, press ■ or T MARK.

To erase a part of a track

Add track marks at the beginning and the end of the part you want to erase, then erase the part.

To erase the whole disc

You can quickly erase all the tracks and data of the MD at the same time. Note that once a recording has been erased, you cannot retrieve it. Be sure to check the contents of the disc you want to erase.

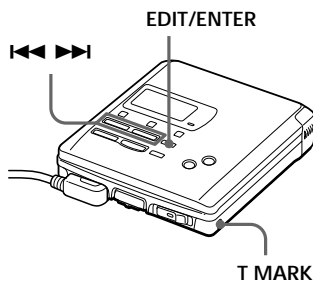

- 1** Press EDIT/ENTER on the recorder.
- 2** Press ◀◀ or ▶▶ repeatedly until " 🎵 : Erase" flashes in the display.
- 3** Press EDIT/ENTER again.
"All Erase?" and "Push ENTER" appear alternately in the display.
To cancel erasing, press ■ or T MARK.
- 4** Press EDIT/ENTER again.
"Toc Edit" flashes in the display, and all the tracks will be erased.
When erasing is complete, "BLANK DISC" appears in the display.

Adding a track mark

You can add track marks so that the part after the new track mark is counted as a new track.

The track numbers will increase as follows.

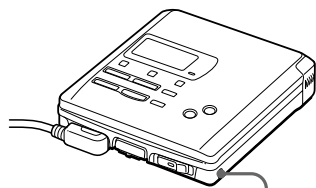
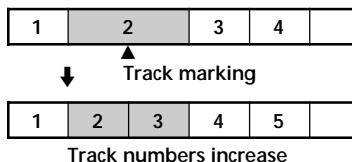

- 1 While playing or pausing an MD, press T MARK on the recorder at the point you want to mark. "MARK ON" appears in the display, and a track mark is added. The track number will increase by one.

To add track marks while recording

Press T MARK on the recorder or TRACK MARK on the remote control.

Note

TRACK MARK on the remote control does not function during playback.

Erasing a track mark

When you record with analog (line) input, unnecessary track marks may be recorded where recording level is low. You can erase a track mark to combine the tracks before and after the track mark. The track numbers will change as follows.

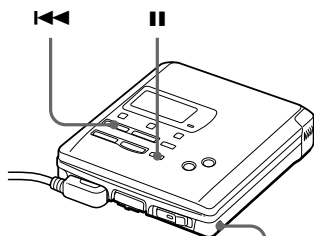
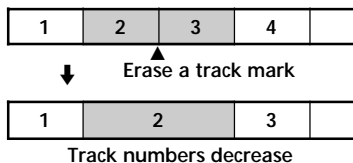

- 1 While playing the track with the track mark you want to erase, press **||** to pause.
- 2 Find the track mark by pressing **⏮** slightly. For example, to erase the third track mark, find the beginning of the third track. "00:00" appears in the display.
- 3 Press T MARK to erase the mark. "MARK OFF" appears in the display. The track mark is erased and the two tracks are combined.



When you erase a track mark, the date, time, and name assigned to the mark are also erased.

Moving recorded tracks

You can change the order of the recorded tracks.

Before moving

Track A	Track B	Track C	Track D
1	2	3	4

After moving

Track A	Track C	Track B	Track D
1	2	3	4

Move track C from the third to the second track.

On the recorder

⏮ ⏭ EDIT/ENTER

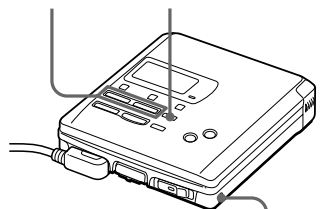

- 1 Press EDIT/ENTER while playing the track you want to move.
" 🎵 : Name" flashes in the display and the recorder plays the selected track repeatedly.
- 2 Press ⏮ or ⏭ repeatedly until " 🎵 : Move" flashes in the display.
- 3 Press EDIT/ENTER again.
For the example above, "MV 003 → 003" appears in the display.
- 4 Press ⏮ or ⏭ repeatedly to select the destination track number.
For the example above, "MV 003 → 002" appears in the display.
To cancel moving, press ■ or T MARK.

- 5 Press EDIT/ENTER again.
The track moves to the selected destination track.

On the remote control

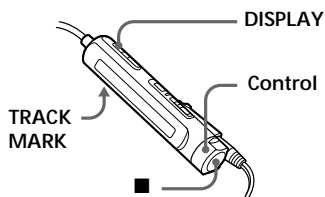

- 1 Press DISPLAY for 2 seconds or more while playing the track you want to move.
" 🎵 : Name" flashes in the display and the recorder plays the selected track repeatedly.
- 2 Turn the control until " 🎵 : Move" appears in the display.
- 3 Press ■.
For the example above, "MV 003 → 003" appears in the display.
- 4 Turn the control to select the destination track number.
For the example above, "MV 003 → 002" appears in the display.
To cancel moving, press TRACK MARK.
- 5 Press ■ again.
The selected track moves just before the destination track.

Labeling recordings

You can name tracks during playback, discs during stop, and both during recording. Each name can be as long as 200 letters.

Each disc can hold up to 1700 alphanumeric letters during playback or stop, and 500 alphanumeric letters during one recording.

On the recorder

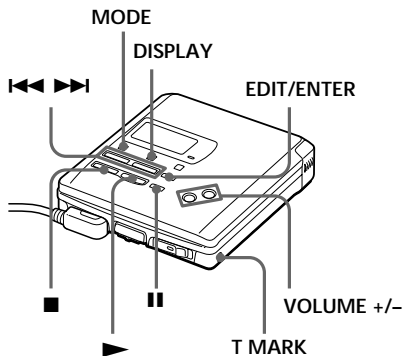

Labeling a disc during stop

- 1 Insert a disc.
To label a disc that is already in the recorder, press ■ to stop.
- 2 Press EDIT/ENTER.
"Ⓜ : Name" flashes in the display.
- 3 Press EDIT/ENTER again.
The disc is ready to be labeled.
- 4 Press ◀◀ or ▶▶ repeatedly to select a letter and press ▶ to enter.
The selected letter stops flashing and the cursor moves to the next input position.

Press	To
	Switch between capital letters, small letters, and marks / numbers.
VOLUME +/-	Move the cursor to the left or right.
◀◀/▶▶	Change the letter to the one before / next one.
DISPLAY	Insert a blank space to type in a new letter.
MODE	Delete a letter and move back all following letters to the left.
■	Cancel labeling.
T MARK	Cancel labeling.

- 5 Repeat step 4 and enter all characters of the label name.
- 6 Press EDIT/ENTER.
The track or disc is labeled.

Labeling a track during playback

- 1 Insert a disc and play the track you want to label.
- 2 Press EDIT/ENTER.
"🎵 : Name" flashes in the display.
- 3 Press EDIT/ENTER again.
The track is ready to be labeled.
- 4 Follow steps 4 to 6 of "Labeling a disc during stop" above.

Labeling a track or a disc during recording

- 1 Press EDIT/ENTER during recording.
"🎵 : Name" flashes in the display.

- 2** To label a track, press EDIT/ENTER again.
To label a disc, press ◀◀ or ▶▶ repeatedly until "Ⓞ : Name" flashes in the display, then press EDIT/ENTER.

- 3** Follow steps 4 to 6 of "Labeling a disc during stop" above.

To cancel labeling, press ■ or T MARK.

Note

If, while labeling a track or disc during recording, the track or disc comes to the end, or the next track begins, the labeling that is input up to that point is registered automatically.

On the remote control

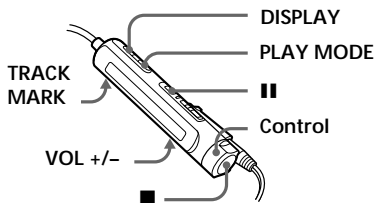

Labeling a disc during stop

- 1** Insert a disc.
To label a disc that is already in the recorder, press ■ to stop.
- 2** Press DISPLAY for 2 seconds or more.
"Ⓞ : Name" flashes in the display.
- 3** Press ■.
The disc is ready to be labeled.
- 4** Turn the control to select a letter and press ■ to enter.
The selected letter stops flashing and the cursor moves to the next input position.

Press/ Turn	To
■	Switch between capital letters, small letters, and marks / numbers.
VOL +/-	Move the cursor to the left or right.
◀◀ / ▶▶ • ▶▶	Change the letter to the one before / next one.
DISPLAY	Insert a blank space to type in a new letter.
PLAY MODE	Delete a letter and move back all following letters to the left.
TRACK MARK	Cancel labeling.

continued

5 Repeat step 4 and enter all characters of the label name.

6 Keep pressing the **■** for 2 seconds or more.
The track or disc is labeled.

Labeling a track during playback

1 Insert a disc and play the track you want to label.

2 Press DISPLAY for 2 seconds or more.
"  : Name" flashes in the display.

3 Press **■**.
The track is ready to be labeled.

4 Follow steps 4 to 6 of "Labeling a disc during stop" above.

Labeling a track or a disc during recording

1 Press DISPLAY for 2 seconds or more during recording.
"  : Name" flashes in the display.

2 To label a track, press **■**.
To label a disc, turn the control to **◀◀** or **▶▶** until "  : Name" flashes in the display, then press **■**.

3 Follow steps 4 to 6 of "Labeling a disc during stop" above.

To cancel labeling, press TRACK MARK.

Note

When the recording is stopped while labeling a track or a disc during recording, or when the playback moves on to the next track while labeling a track, the input at that point is entered automatically.

Available characters

- Capital and small letters of the English alphabet
- Numbers 0 to 9
- ! " # \$ % & () * . ; < = > ?
@ _ ` + - ' , / : _ (space)

To relabel recordings

Follow the steps corresponding to the labeling method until the disc or track is ready to be labeled. Enter a new character over the one you want to change, then press EDIT/ENTER (keep pressing **■** for 2 seconds or more on the remote control).

Notes

- You cannot relabel premastered MDs or label MDs that have not been recorded.
- The recorder is able to display, but cannot label using, Japanese "Katakana" characters.

► Power sources

You can use the recorder on house current or as follows.

In the recorder ...

- a nickel metal hydride rechargeable battery NH-14WM (supplied)

With supplied battery case ...

- two LR6 (size AA) alkaline batteries (not supplied)

It is preferable to use the recorder on house current when recording for a long time.

Charging the nickel metal hydride rechargeable battery

Before using the supplied NH-14WM nickel metal hydride rechargeable battery for the first time, charge it in the recorder.

- 1 Connect the supplied AC power adaptor.

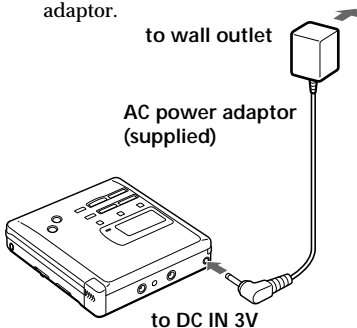

- 2 Insert the NH-14WM into the recorder and close the lid.

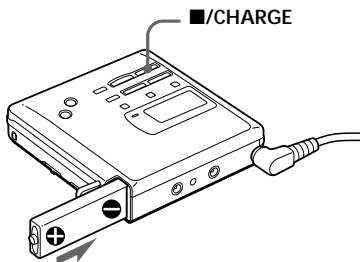

- 3 Press ■/CHARGE. "charging" flashes, □ appears in the display, and charging starts.

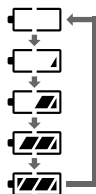

Full charging of a completely discharged rechargeable battery takes about 3 hours. To cancel charging, press ■/CHARGE.

Notes

- During charging, other operations on the recorder are not possible.
- Be sure to use the supplied AC power adaptor.
- Charging time may vary depending on the battery condition.
- When a rechargeable battery is charged for the first time or charged after a long period of disuse, battery life may be shorter than usual. Repeat discharging and recharging a few times. The battery life should return to normal.
- When the battery life of a fully charged rechargeable battery becomes about half the normal life, replace it.
- When carrying the rechargeable battery, keep it in the supplied carrying case. It is dangerous to carry the battery out of its case in your pocket or a bag together with metallic objects such as key rings, as this may cause a short circuit.
- Remove the rechargeable battery from the recorder when it is not to be used for a long time.

Using on a nickel metal hydride rechargeable battery

Be sure the rechargeable battery is fully charged.

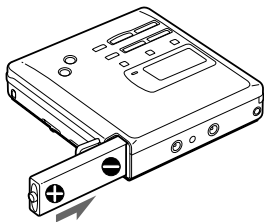

- 1 Insert the fully charged nickel metal hydride rechargeable battery with correct polarity.

Using dry batteries

- 1 Attach the supplied battery case.

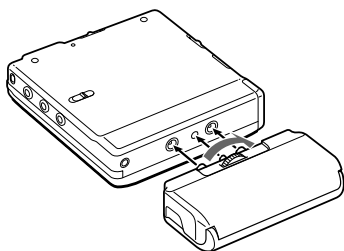

- 2 Insert two LR6 (size AA) dry batteries (not supplied) with correct polarity.

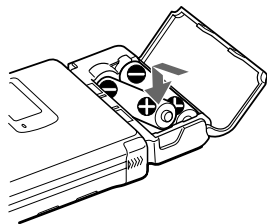

Battery life¹⁾

Batteries	Recording ²⁾	Playback
NH-14WM nickel metal hydride rechargeable battery	Approx. 2.5 hours	Approx. 4 hours
Two LR6 (size AA) Sony alkaline dry batteries	----- ³⁾	Approx. 10 hours
NH-14WM nickel metal hydride rechargeable battery + Two LR6 (size AA)	----- ³⁾	Approx. 16 hours

¹⁾The battery life may be shorter due to operating conditions and the temperature of the location.

²⁾When you record, use a fully charged rechargeable battery.

³⁾Recording time may differ according to the alkaline batteries.

When to replace the batteries

When the dry batteries or rechargeable battery are weak, flashing  or "LOW BATT" appears in the display. Replace the dry batteries or charge the rechargeable battery.

Notes

- Do not use a new dry battery mixed with an used one. Do not mix different types of dry batteries.
- Stop the recorder before replacing batteries.
- When replacing the dry batteries, replace both batteries with new ones.
- The recorder does operate with one dry battery but may not operate properly; always use two dry batteries.

► **Additional information**

Precautions

On safety

Do not put any foreign objects in the DC IN 3 V jack.

On power sources

- Use house current, nickel metal hydride rechargeable battery, two LR6 (size AA) batteries, or car battery.
- For use in your house: Use the AC power adaptor supplied with this recorder. Do not use any other AC power adaptor since it may cause the recorder to malfunction.

Polarity of the plug

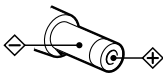

- The recorder is not disconnected from the AC power source (mains) as long as it is connected to the wall outlet, even if the recorder itself has been turned off.
- If you are not going to use this recorder for a long time, be sure to disconnect the power supply (AC power adaptor, dry batteries, rechargeable battery, or car battery cord). To remove the AC power adaptor from the wall outlet, grasp the adaptor plug itself; never pull the cord.
- For use in the car: Use the CPA-9 car connecting pack and the DCC-E230 car battery cord (not supplied).

On heat build-up

Heat may build up in the recorder if it is used for an extended period of time. In this case, leave the recorder turned off until it cools down.

On installation

- Never use the recorder where it will be subjected to extremes of light, temperature, moisture or vibration.
- Never wrap the recorder in anything when it is being used with the AC power adaptor. Heat build-up in the recorder may cause malfunction or damage.

On the headphones

Road safety

Do not use headphones while driving, cycling, or operating any motorized vehicle. It may create a traffic hazard and is illegal in many areas. It can also be potentially dangerous to play your recorder at high volume while walking, especially at pedestrian crossings. You should exercise extreme caution or discontinue use in potentially hazardous situations.

Preventing hearing damage

Avoid using headphones at high volume. Hearing experts advise against continuous, loud and extended play. If you experience a ringing in your ears, reduce the volume or discontinue use.

Caring for others

Keep the volume at a moderate level. This will allow you to hear outside sounds and to be considerate of the people around you.

On the MiniDisc cartridge

- When carrying or storing the MiniDisc, keep it in its case.
- Do not break open the shutter.
- Do not place the cartridge where it will be subject to light, extreme temperatures, moisture or dust.

On cleaning

- Clean the recorder casing with a soft cloth slightly moistened with water or a mild detergent solution. Do not use any type of abrasive pad, scouring powder or solvent such as alcohol or benzene as it may mar the finish of the casing.
- Wipe the disc cartridge with a dry cloth to remove dirt.
- Dust on the lens may prevent the unit from operating properly. Be sure to close the disc compartment lid after inserting or ejecting an MD.

Notes on batteries

Incorrect battery usage may lead to leakage of battery fluid or bursting batteries. To prevent such accidents, observe the following precautions:

- Install the + and - poles of the batteries correctly.
- Do not install new and used batteries or different kinds of batteries together.
- Do not try to recharge dry batteries.
- When the recorder is not to be used for a long time, be sure to remove the batteries.
- If a battery leak should develop, carefully and thoroughly wipe away battery fluid from the battery compartment before inserting new ones.

Note on mechanical noise

The recorder gives off mechanical noise while operating, which is caused by the power-saving system of the recorder and it is not a problem.

To protect a recorded MD

To record-protect an MD, slide open the tab at the side of the MD. In this position, the MD cannot be recorded. To record again, slide the tab back so the tab is visible.

Back of the MD

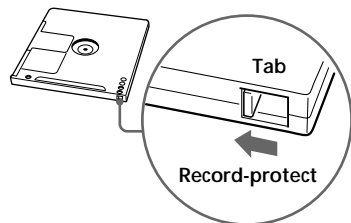

Note on digital recording

This recorder uses the Serial Copy Management System, which allows only first-generation digital copies to be made from premastered software. You can only make copies from a home-recorded MD by using the analog (line out) connections.

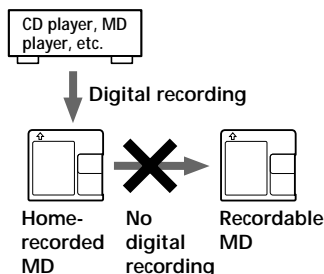

If you have any questions or problems concerning your recorder, please consult your nearest Sony dealer. (If a trouble occurred when the disc was in the recorder, we recommend that the disc be left in the recorder when you consult your Sony dealer so that the cause of trouble may be better understood.)

Troubleshooting

Should any problem persist after you have made these checks, consult your nearest Sony dealer.

Symptom	Cause/Solution
The recorder does not work or works poorly.	<ul style="list-style-type: none">• Audio sources may not be securely connected.<ul style="list-style-type: none">➔ Disconnect the audio sources once and connect them again (pages 6,11).• The HOLD function is turned on ("HOLD" appears in the display when you press an operation button on the recorder).<ul style="list-style-type: none">➔ Disable HOLD by sliding the HOLD switch in the opposite direction of the arrow (page 20).• Moisture has condensed inside the recorder.<ul style="list-style-type: none">➔ Take the MD out and leave the recorder in a warm place for several hours until the moisture evaporates.• The rechargeable battery or dry batteries are weak (☐ or "LOW BATT" flashes).<ul style="list-style-type: none">➔ Charge the rechargeable battery or replace the dry batteries (pages 27, 28).• The rechargeable battery or dry batteries have been installed incorrectly.<ul style="list-style-type: none">➔ Install the batteries correctly (page 27, 28).• You pressed a button while the disc indication was rotating quickly.<ul style="list-style-type: none">➔ Wait until the indication rotates slowly.• When recording digitally from a portable CD player, you did not use AC power or did not disable the anti-skip function such as ESP (page 11).• The analog recording was made using a connecting cord with an attenuator.<ul style="list-style-type: none">➔ Use a connecting cord without an attenuator (page 6).• The AC power adaptor was unplugged during recording or a power outage occurred.• While operating, the recorder received a mechanical shock, too much static, abnormal power voltage caused by lightning, etc.<ul style="list-style-type: none">➔ Restart the operation as follows.<ol style="list-style-type: none">1 Disconnect all the power sources.2 Leave the recorder for about 30 seconds.3 Connect the power source.• The disc is damaged or does not contain proper recording or editing data.<ul style="list-style-type: none">➔ Reinsert the disc. If this fails, rerecord.

continued

Symptom	Cause/Solution
No sound comes through the headphones.	<ul style="list-style-type: none"> • The headphones plug is not firmly connected. <ul style="list-style-type: none"> ➔ Plug in the plug of the headphones firmly to the remote control. Plug in the plug of the remote control firmly to Ⓞ/REMOTE. • Volume is too low. <ul style="list-style-type: none"> ➔ Adjust the volume by pressing VOLUME +/- (VOL +/- on the remote control). • AVLS is on. <ul style="list-style-type: none"> ➔ Slide AVLS to NORM (page 18).
An MD is not played from the first track.	<ul style="list-style-type: none"> • Disc playing stopped before it came to the last track. <ul style="list-style-type: none"> ➔ Press ⏮ repeatedly or open and close the lid once to go back to the beginning of the disc, and restart playing after checking the track number in the display.
Playback sound skips.	<ul style="list-style-type: none"> • The recorder is placed where it receives continuous vibration. <ul style="list-style-type: none"> ➔ Put the recorder on a stable place. • A very short track may cause sound to skip.
Sound has a lot of static.	<ul style="list-style-type: none"> • Strong magnetism from a television or such device is interfering with operation. <ul style="list-style-type: none"> ➔ Move the recorder away from the source of strong magnetism.
Cannot find the track marks.	<ul style="list-style-type: none"> • You pressed ⏸ after pressing ⏮ or ⏭. ➔ Press ⏸ before pressing ⏮ or ⏭.
The rechargeable battery does not start charging.	<ul style="list-style-type: none"> • The rechargeable battery has been inserted incorrectly or the AC power adaptor has been connected incorrectly. <ul style="list-style-type: none"> ➔ Insert the battery correctly or connect the AC power adaptor correctly.
The clock loses time or the display flashes. The recording date was not stamped onto the disc.	<ul style="list-style-type: none"> • The built-in battery for the clock is weak. <ul style="list-style-type: none"> ➔ Connect the AC power adaptor to DC IN 3 V on the recorder and the wall outlet to charge the built-in battery. After charging, set the clock again (page 16). Note that the clock may gain or lose up to about 2 minutes per month under normal condition.
The lid does not open.	<ul style="list-style-type: none"> • The power sources have been disconnected during recording or editing, or the batteries have been exhausted. <ul style="list-style-type: none"> ➔ Set the power sources again, or replace the exhausted batteries with new ones.

System limitations

The recording system in your MiniDisc recorder is radically different from those used in cassette and DAT decks and is characterized by the limitations described below. Note, however, that these limitations are due to the inherent nature of the MD recording system itself and not to mechanical causes.

Symptom	Cause
"TR FULL" appears even before the disc has reached the maximum recording time (60 or 74 minutes).	When 254 tracks have been recorded on the disc, "TR FULL" appears regardless of the total recorded time. More than 254 tracks cannot be recorded on the disc. To continue recording, erase unnecessary tracks.
"TR FULL" appears even before the disc has reached the maximum track number or recording time.	Repeated recording and erasing may cause fragmentation and scattering of data. Although those scattered data can be read, each fragment is counted as a track. In this case, the number of tracks may reach 254 and further recording is not possible. To continue recording, erase unnecessary tracks.
Track marks cannot be erased. The remaining recording time does not increase even after erasing numerous short tracks.	When the data of a track is fragmented, the track mark of a fragment under 12 seconds long cannot be erased. You cannot combine a track recorded in stereo and a track recorded in monaural; nor can you combine a track recorded with digital connection and a track recorded with analog connection. Tracks of under 12 seconds in length are not counted and so erasing them may not lead to an increase in the recording time.
The total recorded time and the remaining time on the disc may not total the maximum recording time (60 or 74 minutes).	Normally, recording is done in minimum units of approximately 2 seconds. When recording is stopped, the last unit of recording always uses this unit of 2 seconds even if the actual recording is shorter. Likewise, when recording is restarted after the stop, the recorder will automatically insert a blank space amounting to 2 seconds before the next recording. (This is to prevent accidental erasing of a previous track whenever a new recording is started). Therefore, the actual recording time will decrease whenever a recording is stopped; a maximum of 6 seconds compared to the potential recording time for each stop.
The edited tracks may exhibit sound dropout during search operations.	The fragmentation of data may cause sound dropout while searching because the tracks are played in higher speed than normal playback.

Messages

If the following error messages flash in the display window, check the chart below.

Error message	Meaning/Remedy
BLANK DISC	<ul style="list-style-type: none">• An MD with no recording on it is inserted.<ul style="list-style-type: none">➤ Insert a recorded MD.
DISC ERR	<ul style="list-style-type: none">• The disc is damaged or does not contain proper recording or editing data.<ul style="list-style-type: none">➤ Reinsert the disc. If this fails, rerecord.
DISC FULL	<ul style="list-style-type: none">• There is no more space to record on the disc (less than 12 seconds available).<ul style="list-style-type: none">➤ Replace the disc.
Data Save	<ul style="list-style-type: none">• The MD player is recording information (sounds) from the memory to the disk.<ul style="list-style-type: none">➤ Wait until this process is completed. Do not expose the player to any physical shock, nor disrupt power supply.
Toc Edit	<ul style="list-style-type: none">• The MD player is recording information (track start and end position) from the memory to the disk.<ul style="list-style-type: none">➤ Wait until this process is completed. Do not expose the player to physical shock, nor disrupt power supply.
BUSY	<ul style="list-style-type: none">• You tried to operate the recorder while it was accessing the recorded data.<ul style="list-style-type: none">➤ Wait until the message goes out (in rare cases, it may take 2–3 minutes).
NAME FULL	<ul style="list-style-type: none">• You tried to enter more than 200 letters to label a single track or disc.• You tried to enter a total of more than 1700 letters for track or disc names during playback or stop.• You tried to enter a total of more than 500 letters for track or disc names during a single recording.<ul style="list-style-type: none">➤ Enter the characters within the limit.
Hi DC in	<ul style="list-style-type: none">• Voltage of the power supply is too high (The supplied AC power adaptor or the recommended car battery cord is not used).<ul style="list-style-type: none">➤ Use the supplied AC power adaptor or the recommended car battery cord.
HOLD	<ul style="list-style-type: none">• The recorder is locked.<ul style="list-style-type: none">➤ Slide HOLD against the arrow to unlock the recorder (page 20).
LOW BATT	<ul style="list-style-type: none">• Batteries are weak.<ul style="list-style-type: none">➤ Charge the rechargeable battery or replace the dry batteries (pages 27, 28).
MEM OVER	<ul style="list-style-type: none">• You tried to record when there is no indication in the display, with the recorder placed where it receives continuous vibration.<ul style="list-style-type: none">➤ Put the recorder on a stable place, and start recording again.

Error message	Meaning/Remedy
NO COPY	<ul style="list-style-type: none"> You tried to make a copy from a disc that is protected by the Serial Copy Management System. You cannot make copies from a digitally connected source which was itself recorded using digital connection. <ul style="list-style-type: none"> ➔ Use analog connection instead (page 6).
NO DISC	<ul style="list-style-type: none"> You tried to play or record with no disc in the recorder. <ul style="list-style-type: none"> ➔ Insert an MD.
NO SIGNAL	<ul style="list-style-type: none"> The recorder could not detect digital input signals. <ul style="list-style-type: none"> ➔ Make sure that the source is connected firmly (page 11).
P/B ONLY	<ul style="list-style-type: none"> You tried to record or edit on a premastered MD (P/B stands for "playback".) <ul style="list-style-type: none"> ➔ Insert a recordable MD.
PROTECTED	<ul style="list-style-type: none"> You tried to record or edit on a MD with the tab in the record-protect position. <ul style="list-style-type: none"> ➔ Slide the tab back (page 30).
SORRY	<ul style="list-style-type: none"> You tried to erase the track mark at the beginning of the first track. You tried to erase a track mark to combine tracks the recorder cannot combine (a track recorded in stereo and in mono, for example). You tried to press DIGITAL MEGA BASS when the LINE OUT jack is plugged in. You tried to press ■■ or T MARK during synchro-recording.
TEMP OVER	<ul style="list-style-type: none"> Heat has built up in the recorder. <ul style="list-style-type: none"> ➔ Let the recorder cool down.
TR FULL	<ul style="list-style-type: none"> There is no more space for new data when you are editing the MD. <ul style="list-style-type: none"> ➔ Erase unnecessary tracks (page 21).
TrPROTECT	<ul style="list-style-type: none"> You tried to record or edit on a track that is protected from erasing. <ul style="list-style-type: none"> ➔ Record or edit on other tracks.
EDITING	<ul style="list-style-type: none"> You pressed a key on the recorder while editing on the remote control, or vice versa.

Specifications

System

Audio playing system

MiniDisc digital audio system

Laser diode properties

Material: GaAlAs

Wavelength: $\lambda = 780$ nm

Emission duration: continuous

Laser output: less than 44.6 μ W

(This output is the value measured at a distance of 200 mm from the lens surface on the optical pick-up block with 7 mm aperture.)

Recording and playback time

Maximum 74 minutes (MDW-74, stereo recording)

Maximum 148 minutes (MDW-74, monaural recording)

Revolutions

400 rpm to 900 rpm (CLV)

Error correction

Advanced Cross Interleave Reed Solomon Code (ACIRC)

Sampling frequency

44.1 kHz

Sampling rate converter

Input: 32 kHz/44.1 kHz/48 kHz

Coding

Adaptive Transform Acoustic Coding (ATRAC)

Modulation system

EFM (Eight to Fourteen Modulation)

Number of channels

2 stereo channels

1 monaural channel

Frequency response

20 to 20,000 Hz \pm 3 dB

Wow and Flutter

Below measurable limit

Inputs

Microphone: stereo mini-jack, 0.22–0.78 mV

Line in: stereo mini-jack, 69–194 mV

Optical (Digital) in: optical (digital) mini-jack

Outputs

Headphones: stereo mini-jack, maximum output level 5 mW+ 5 mW, load impedance 16 ohm

Line out: stereo mini-jack, 194 mV, load impedance 10 kilohm

General

Power requirements

Sony AC Power Adaptor (supplied)

connected at the DC IN 3 V jack:

120 V AC, 60 Hz (US model)

230–240 V AC, 50/60 Hz (UK and Hong

Kong model)

240 V AC, 50/60 Hz (Australia and New Zealand model)

Nickel metal hydride rechargeable battery

NH-14WM (supplied)

Two LR6 (size AA) alkaline batteries (not supplied)

Battery operation time

See "Battery life" (page 28)

Dimensions

Approx. 78.9 x 18.9 x 84 mm (w/h/d)

(3 ¹/₈ x 3 ³/₄ x 3 ³/₈ in.)

Mass

Approx. 147 g (5.2 oz) the recorder only

Approx. 190 g (6.7 oz) incl. a recordable MD,

and NH-14WM nickel metal hydride

rechargeable battery

Supplied accessories

AC power adaptor (1)

Headphones with a remote control (1)

NH-14WM nickel metal hydride

rechargeable battery (1)

Rechargeable battery carrying case (1)

Dry battery case (1)

Carrying pouch (1)

Optional accessories

Optical Cable

POC-151HG, POC-152HG, POC-MZ1,
POC-MZ2, POC-15B, POC-15AB, POC-
DA12SP

Line Cable RK-G129, RK-G136

Car Connecting Pack, CPA-9

Car Battery Cord DCC-E230

Stereo Microphones ECM-717, ECM-MS907, ECM-MS957

Stereo Headphones* MDR-series

Active Speakers SRS-A41, SRS-A91

Recordable MDs MDW-series

MiniDisc Carrying Case CK-MD4

MiniDisc Filing Box CK-MD10

Your dealer may not handle some of the above listed accessories. Please ask the dealer for detailed information about the accessories in your country.

US and foreign patents licensed from Dolby Laboratories Licensing Corporation.

Design and specifications are subject to change without notice.

* Whether you should plug the headphones directly to /REMOTE on the main unit or to a remote control, use only headphones with stereo mini plugs.

stereo mini plugs

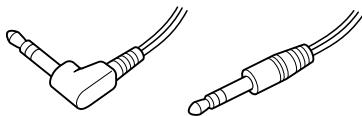

What is an MD?

How MiniDisc works

MiniDisc (MD) comes in two types: premastered (prerecorded) and recordable (blank). Premastered MDs, recorded at music studios, can be played back almost endlessly. However, they can't be recorded on or over like cassette tapes. To record, you must use a "recordable MD".

Premastered MDs

Premastered MDs are recorded and played like regular CDs. A laser beam focuses on the pits in the surface of the MD and reflects the information back to the lens in the recorder. The recorder then decodes the signals and plays them back as music.

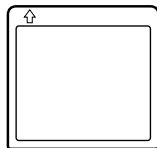

Recordable MDs

Recordable MDs, which use magneto-optical (MO) technology, can be recorded again and again. The laser inside the recorder applies heat to the MD, demagnetizing the magnetic layer of the MD. The recorder then applies a magnetic field to the layer. This magnetic field corresponds exactly to the audio signals generated by the connected source. (The north and south polarities equate to digital "1" and "0".) The demagnetized MD adopts the polarity of the magnetic field, resulting in a recorded MD.

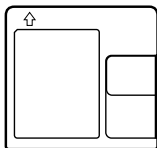

How the MiniDisc got so small

The 2.5-inch MiniDisc, encased in a plastic cartridge that looks like a 3.5-inch diskette (see illustration above), uses a new digital audio compression technology called ATRAC (Adaptive TRansform Acoustic Coding). To store more sound in less space, ATRAC extracts and encodes only those frequency components actually audible to the human ear.

Quick Random Access

Like CDs, MDs offer instantaneous random access to the beginning of any music track. Pre-mastered MDs are recorded with location addresses corresponding to each music selection. Recordable MDs are manufactured with a "User TOC Area" to contain the order of the music. The TOC (Table of Contents) system is similar to the "directory management system" of floppy disks. In other words, starting and ending addresses for all music tracks recorded on the disc are stored in this area. This lets you randomly access the beginning of any track as soon as you enter the track number (AMS), as well as label the location with a track name as you would a file on a diskette.

Shock-Resistant Memory

One major drawback of optical read systems is that they can skip or mute when subjected to vibration. The MD system resolves this problem by using a buffer memory that stores audio data.

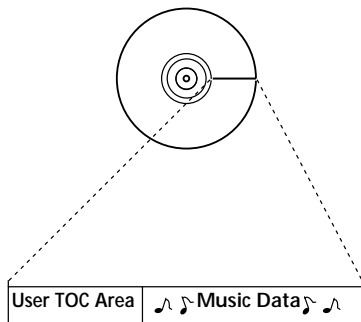

Contains the order and start/end points of the music.

Looking at the controls

See pages in () for more details.

The recorder

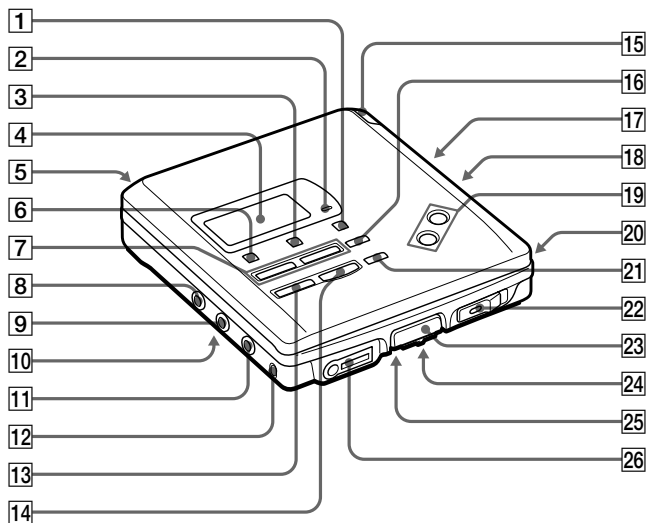

- | | |
|--|---|
| 1 END SEARCH button (7) | 16 EDIT/ENTER button (21) |
| 2 REC indicator (14) | 17 AVLS switch (at the bottom) (18) |
| 3 DISPLAY button (14, 19) | 18 SYNCHRO REC (synchro-recording) switch (11) |
| 4 Display window (14, 19) | 19 VOLUME +/- button (9) |
| 5 DC IN 3V jack (at the rear) (6) | 20 T MARK button (21) |
| 6 MODE button (17) | 21 ■■ (pause) button (7, 9) |
| 7 ◀◀/▶▶ (search / AMS) button (7, 9) | 22 REC (record) switch (7) |
| 8 LINE IN (OPTICAL) jack (6, 11) | 23 OPEN button (6) |
| 9 MIC (PLUG IN POWER) jack (12) | 24 HOLD switch (20) |
| 10 MIC SENS switch (at the bottom) (12) | 25 CLOCK SET button (at the bottom) (16) |
| 11 LINE OUT jack (20) | 26 🎧 (headphones)/REMOTE jack (8) |
| 12 DIGITAL MEGA BASS button (18) | |
| 13 ■/CHARGE button (7, 9, 27) | |
| 14 ▶ (play) button (7, 9) | |
| 15 Battery compartment (at the rear) (27) | |

The display window

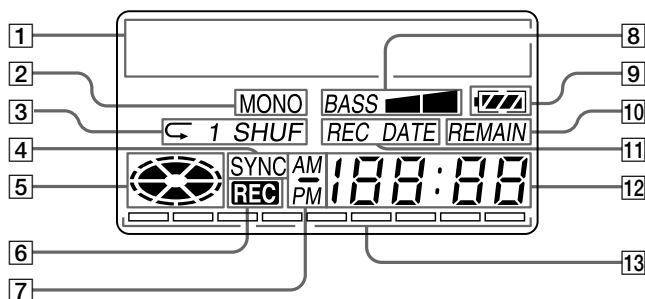

- 1** Character information display (14, 19)
Displays the disc and track names, date, error messages, track numbers, etc.
- 2** MONO (monaural) indication
- 3** Play mode indication
Shows the play mode of the MD.
- 4** SYNC (synchro-recording) indication
- 5** Disc indication
Shows that the disc is rotating for recording, playing or editing an MD.
- 6** REC indication (7)
Lights up while recording. When flashing, the recorder is in record standby mode.
- 7** AM/PM indication (16)
Lights up along with the time indication in the 12-hour system.
- 8** Mega bass indication (18)
- 9** Battery indication (27)
Shows battery condition.
- 10** REMAIN (remaining time/tracks) indication (14, 19)
Lights up along with the remaining time of the track, the remaining time of the MD, or the remaining number of tracks.
- 11** REC DATE (recorded/current date) indication
Lights up along with the date and time the MD was recorded. When only "DATE" lights up, the current date and time are displayed.
- 12** Time display (14, 19)
Shows the recorded time, current time, elapsed time of the track or MD being recorded or played.
- 13** Level meter
Shows the volume of the MD being played or recorded.

The headphones with a remote control

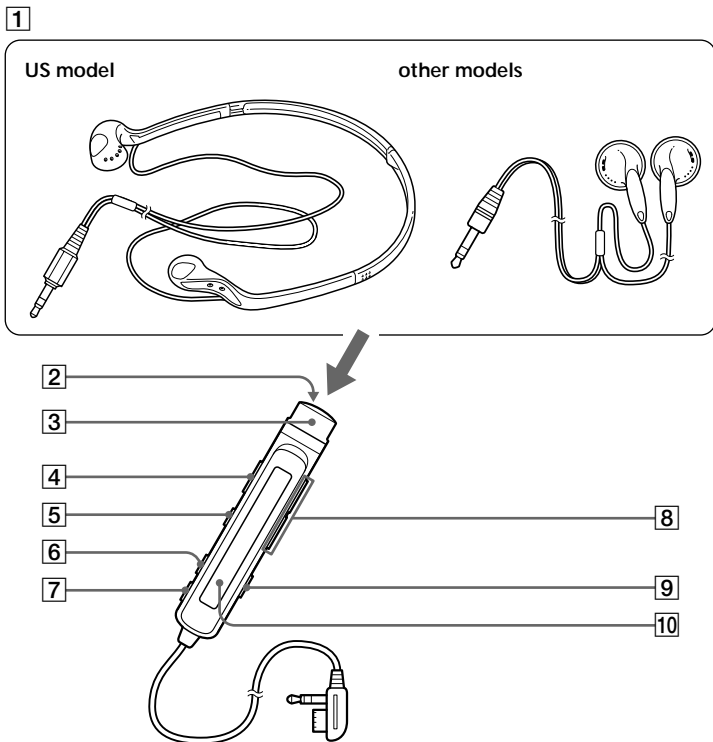

1 Headphones

Can be replaced with optional headphones.

2 ■ (stop) button (7,9)

3 Control (9)

To play, turn to ►•►► during stop.
Turn to ►•►► during play to search the beginning of the succeeding track; hold in this position to fast-forward.
Turn to ◀◀◀ during play to search the beginning of the preceeding track; hold in this position to rewind.

4 HOLD switch (20)

Slide to lock the controls of the remote control.

5 || (pause) button (7,9)

6 PLAY MODE button (17)

7 DISPLAY button (15, 19)

8 VOL (volume) +/- buttons (9)

9 TRACK MARK button (22)

10 Display window (15, 19)

For customers in the United States

Unfold the supplied headphones as shown in the illustration below.

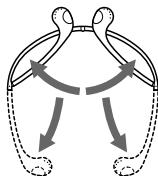

Sony  line <http://www.world.sony.com/>
