

TOA 900 SERIES POWER AMPLIFIER

P-924A

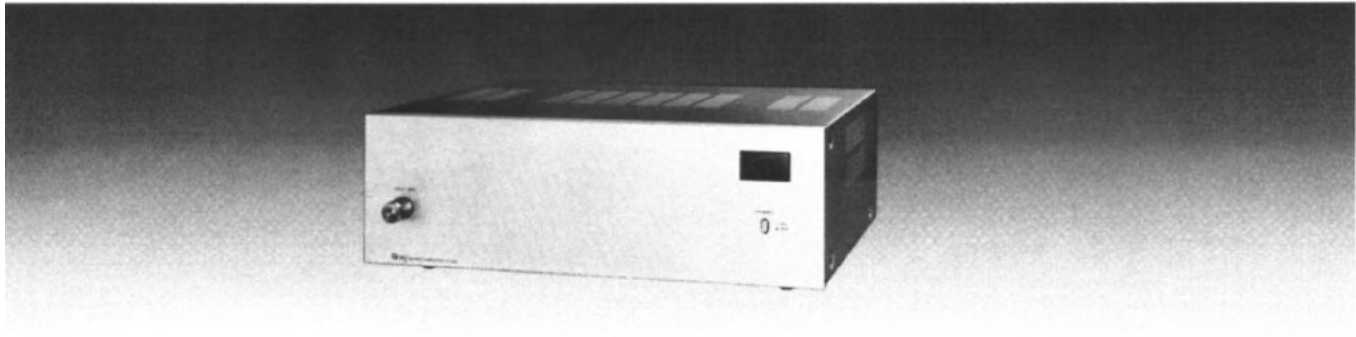

Features

- 1 Wide frequency response; 20 — 20,000 Hz, ± 1 dB
- 2 Low distortion and noise level
- 3 Excellent output regulation
- 4 A full range of plug-in modules
- 5 Self-protecting circuitry design
- 6 Varied output impedances; 4 and 8 ohms, 25 and 70 volts
- 7 Input level switch (selectable 1,000mV/100mV)
- 8 Portable or rack-mounting type

General Descriptions

The TOA P-924A Power Amplifier delivers up to 240 watts of power at less than 0.5% total harmonic distortion (THD) from 20 to 20,000 Hz (transformerless 4-ohm output). The P-924A has a high-impedance direct input and an input port (edge connector) to accept one module accessory. Module selection is determined by application among the TOA plug-in modules:

The M-01 series, M-03 series, M-51 series and M-61 series Microphone Preamplifiers, R-01 Mag. Phono Preamplifier, the U-01 series, U-21 series and U-61 series Auxiliary Preamplifiers for high-level sources, the B-01 series Bridging Transformers for bridging high-impedance lines, the L-01 series Line Matching Transformers for matching 600-ohm lines, and the S-01, S-02 and S-03 Tone signal generators for generating attention-getting signals and 1 KHz sine wave for testing within the total system.

The P-924A has a low-cut switch for cutoff frequency of 60 Hz, and an input-level switch for input sensitivity of 1V (0dBv) or 100mV (−20dBv). Output terminals provide connections for 4-ohm and 8-ohm speakers, plus 25-volt and 70-volt speaker distribution outlets.

With plug-in modules, the TOA P-924A Power Amplifier may be used as a pre/power amplifier.

The P-924A can be rack mounted by using the MB-931A Rack-mounting Bracket accessory. The PF-911 Perforated Panel (1.73 inches, 1 rack unit) accessory provides suitable ventilation, finished in color to match the P-924A.

TOA 900 SERIES

Front Panel Controls and Features

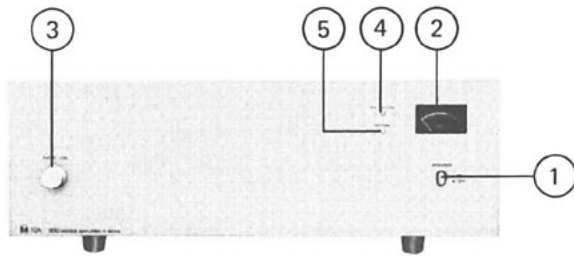

Item	Name	Function/Description
1	POWER ON-OFF SWITCH	Applies line power. Two-position pushbutton switch for on-off modes.
2	METER	Indicates the output level of the amplifier. At rated output, it shows 0 VU (at continuous sine-wave signal input). When power is turned on, meter illuminates.
3	INPUT VOLUME CONTROL	Adjust gain of INPUT.
4	PROTECTION INDICATOR (RED)	This LED indicator comes on and goes out in about 5 seconds after the power switch is turned on. If the LED indicator remains lit indicating that a muting relay is not activated, turn the power switch off after disconnecting the speaker line and turn it on again. As a result, <ol style="list-style-type: none"> if the LED indicator goes out in about 5 seconds, the speaker line may be short-circuited or overloaded. Check the speaker line. unless the LED indicator still goes out, abnormality has occurred in the power amplifier stage. Check the power amplifier stage.
5	NORMAL INDICATOR (GREEN)	Lights up when the amplifier is normally working.

Rear Panel Controls and Features

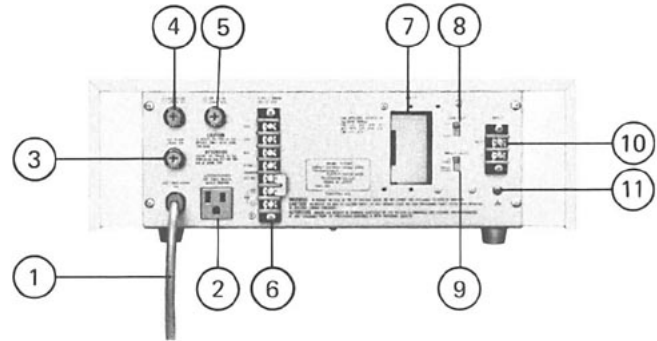

Item	Name	Function /Description						
1	AC POWER SUPPLY CORD	Connects to power source.						
2	AC OUTLET (Unswitched)	Provides AC power for auxiliary equipment with power consumption of up to 500W.						
3	AC FUSE	Protects amplifier from excessive current drain. Replace only with same type fuse.						
4	DC FUSE (-)	Refer to qualified service personnel if fuse blows repeatedly.						
5	DC FUSE (+)	<table border="1"> <tr> <td>AC FUSE</td> <td>250V 7A</td> </tr> <tr> <td>DC FUSE (-)</td> <td>250V 8A</td> </tr> <tr> <td>DC FUSE (+)</td> <td>250V 8A</td> </tr> </table>	AC FUSE	250V 7A	DC FUSE (-)	250V 8A	DC FUSE (+)	250V 8A
AC FUSE	250V 7A							
DC FUSE (-)	250V 8A							
DC FUSE (+)	250V 8A							
6	OUTPUT TERMINALS	Connect to speakers.						
7	MODULE INPUT PORT	Accepts PLUG-IN MODULES which are optionally available. Module selection is determined by application.						
8	LOW-CUT SWITCH	Cuts off unnecessary low frequency.						
9	INPUT LEVEL SWITCH	Selects input sensitivity. Place in "1V (0dBv)" position when normally used as a power amplifier. Note: The position of INPUT-LEVEL SWITCH should be changed according to modules used or equipment connected to DIRECT INPUT TERMINAL.						
10	DIRECT INPUT TERMINAL	Connects directly to external equipment without using modules. Unbalanced 10k ohms.						
11	EARTH TERMINAL	Normally connects to a record player's ground.						

Input Connections

• Two types of input terminals are provided on the rear for input connections.

- (1) 2P terminal (marked HOT, E)
It is provided for direct input (unbalanced, 10k ohms) without using plug-in modules. This terminal is directly connected with a potentiometer inside.
- (2) Plug-in module input
Select the desired modules according to application.

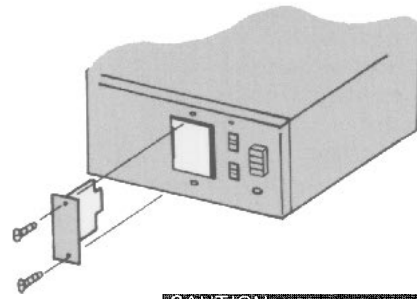

CAUTION
Modules should not be inserted or removed while the amplifier is turned on.

* DIRECT INPUT TERMINAL and MODULE INPUT are not usable simultaneously.

- Plug the module into INPUT PORT, sliding it between the guide rails, and secure with two screws.
- When INPUT PORT is not occupied, cover the PORT with the blank panel, and secure it with screws.
- Be sure that INPUT-LEVEL SWITCH is in the proper position for the modules used or the equipment connected to DIRECT INPUT TERMINAL.
- When the P-924A is used in combination with a mixer preamplifier or serves as an incremental power amplifier, normally place INPUT LEVEL SWITCH in "1V (0dBv)" position.

Plug-in Modules and Input Level SW Setting

Plug-in Modules	Model No.	Input level SW Setting	
		1V (0dBV)	100mV (-20dBV)
Balanced low impedance microphone preamp. module (with presettable low-cut filter, high-cut filter and gain controls)	—	M-01	
	Remote Volume control	M-21	
	Voice Gate	M-51	
	Compressor	M-61	○
Unbalanced high impedance microphone preamp module (with presettable low-cut filter, high-cut filter and gain controls)	—	M-03	○
Equalized mag phono preamp module (with presettable gain control)	—	R-01	○
Unbalanced high impedance auxiliary preamp. module (with presettable gain control)	—	U-01	
	Remote Volume control	U-21	○
	Compressor	U-61	
Balanced 10kΩ bridging transformer module	—	B-01	○
Balanced 600Ω bridging transformer module	—	L-01	○
Signal tone generator module (with presettable output level control)	1kHz Sine Wave	S-01	
	Yelp and buzzer	S-02	○
	One-tone chime and continuous one-tone chime	S-03	

*See PLUG-IN MODULES for detail.

Output Connections P-924A

The speaker outputs of the amplifier are 4Ω, 8Ω, 25V and 70V. Connect speakers to one of these outputs.

Class 2 wiring may be used.

Since these outputs consist of 8Ω, 25V and 70V via the output transformer (matching transformer) and direct output of 4Ω, the connecting method differs in each case. See the following diagrams. Note: Impedances indicated below imply total speaker system (load) impedance.

- When connecting speakers to any one of the outputs of 8Ω, 25V or 70V (BALANCED TRANSFORMER OUTPUT);

<P-924A>

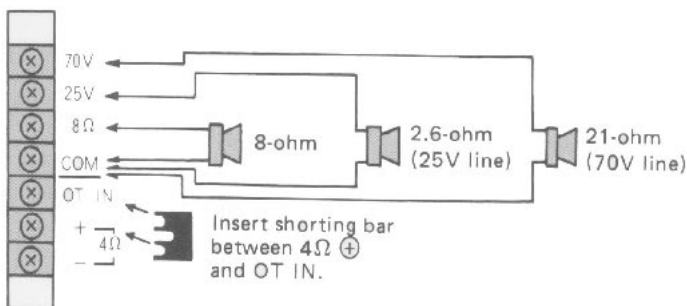

Note:

In this case, the LOW-CUT SWITCH should be "CUT" position. This amplifier is characteristically flat even in the low frequency range. Therefore, in TRANS OUTPUT, the acoustic effect and frequency-response characteristics may be altered. In TRANS OUTPUT, cut off unnecessary low frequency to obtain the best acoustic condition.

Place the LOW-CUT SWITCH in "CUT" position

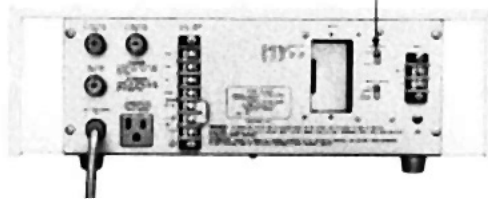

- When connecting speakers to the 4Ω output. (UNBALANCED DIRECT OUTPUT);

<P-924A>

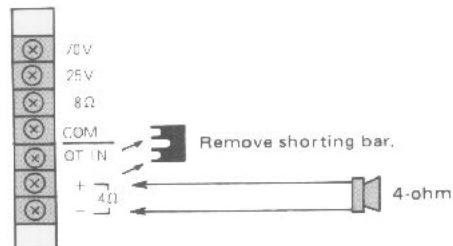

TOA 900 SERIES

Installation

- Do not block cover ventilation holes.
- The amplifier should not be placed in areas;
 1. with poor ventilation
 2. exposed to direct sunlight.
 3. with high ambient temperature or adjacent to heat-generating equipment.
 4. with high humidity or dusty levels.
 5. susceptible to vibration.

CAUTION:

Do not remove the case or you may encounter an electric shock.

Operation

When all connections are completed, turn power switch on. Then, the meter is illuminated. Approx. 5 seconds after switching power on, the amplifier comes into operation.

ADJUSTMENT OF VOLUME CONTROL

Adjust the input volume control to obtain appropriate output level. In normal use of BGM playing or announcement, the deflection of the meter is recommended to be within the range as indicated in the drawing. Tone quality will be considerably deteriorated if the pointer indicates around 0 VU.

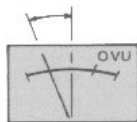

In normal use of BGM playing or announcement.

The pointer of meter indicates 0 VU if continuous signals like sine waves are applied to the input of the amplifier.



Continuous signals

When the power amplifier is used in combination with a mixer pre-amplifier, adjust the total gain at the mixer preamplifier with the gain setting of the power amplifier at maximum.

Rack Mounting

To mount the amplifier in a standard 19-inch equipment rack, use the MB-931A Rack-mounting Bracket accessory.

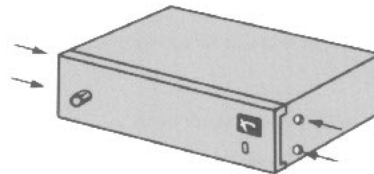

Remove 4 screws securing case.

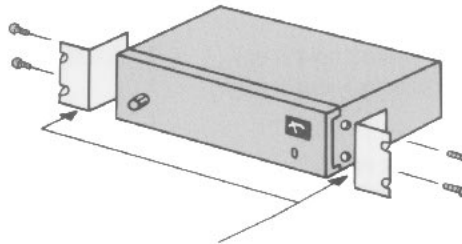

MB-931A
(Silver)
(OPTION)

Fix the MB-931A with attached 4 screws. The length of the screws should not exceed 12mm (1/2 inches).

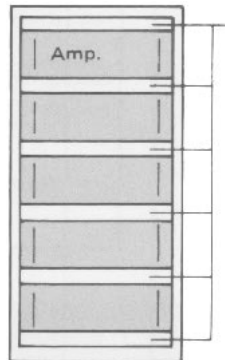

Perforated Panel
PF-911 (OPTION)
(Silver)

If two or more amplifiers are mounted in an equipment rack, space should be provided between the units for ventilation. The PF-911 Perforated Panel is recommended for this purpose.

Servicing

• Unpacking

Upon receipt of the amplifier shipment, please inspect for any damage incurred in transit. If damage is found, please notify your local TOA representative and the transportation company immediately.

State date, nature of damage, whether any damage was noticed on the shipping container, prior to unpacking. Please give waybill number of shipping order.

• Failure

Should amplifier fail, contact your nearest TOA authorized contractor or service center.

Specifications

P-924A	
Type	Power amplifier
Output	(D) 240W RMS (T) 220W RMS
Power Band Width	(D) 20-20,000 Hz, 0.5% THD (T) 50-20,000 Hz, 0.5% THD
Frequency Response	(D) 20 -20,000 Hz, ±1 dB (T) 20- 15,000 Hz, ±1 dB (T) 20 -20,000 Hz, -3dB
Total Harmonic Distortion	0.01% at 1 kHz, rated output
inputs	One Input Port : Port accepts any input module except T-01, which cannot be used. One Direct Input Note : Use of direct input prohibits use of modular input port.
Input Sensitivity/Impedance	Input Port : 100 mV or 1,000 mV (Switchable)/10k ohms Direct Input : 100 mV or 1,000 mV (Switchable)/10k ohms
Outputs (D) = Direct (T) = Transformer	Main (T): 8 ohms, 25 & 70 volts, balanced Main (D): 4 ohms, unbalanced
Output Regulation (1 kHz)	(D) Less than 0.5 dB, no load to full load (T) Less than 1.0 dB, no load to full load
Signal to Noise Ratio (Band Pass 20 — 20,000 Hz)	Input level switch in 0 dBv (1,000 mV) position : 105 dB Input level switch in -20 dBv (100 mV) position : 90 dB
Controls	1 Input gain control 1 Input level switch 1 Power ON/OFF switch 1 Low-cut switch (60 Hz, 6 dB/octave)
Indicator	1 Illuminated VU meter, 2 LED for protection circuit
Protection	Self-protection, with 2 AC fuses (1 inside) and 2 DC fuses
Connectors	Inputs Card-edge connector and screw-terminal strip Output Screw-terminal strip AC output 3-pin grounding type AC power cord/plug SJT, 3-prong type
Power Consumption	AC 120 volts, 60 Hz, 3A
Temperature Range	-10°C to +60°C (12°F to 140°F)
Dimensions in mm (inches) (high) x (wide) x (deep)	150.5 (5.92") x 420 (16.54") x 333 (13.11") Rack-mounting space size "3U" (5.21")
Weight (without input modules)	19.5kg (43 lbs.)
Color	Silver
Other Features	Output disconnected for approx. 5 sec. after switching power on.

* Specifications are subject to change without notice.

Block Diagram P-924A

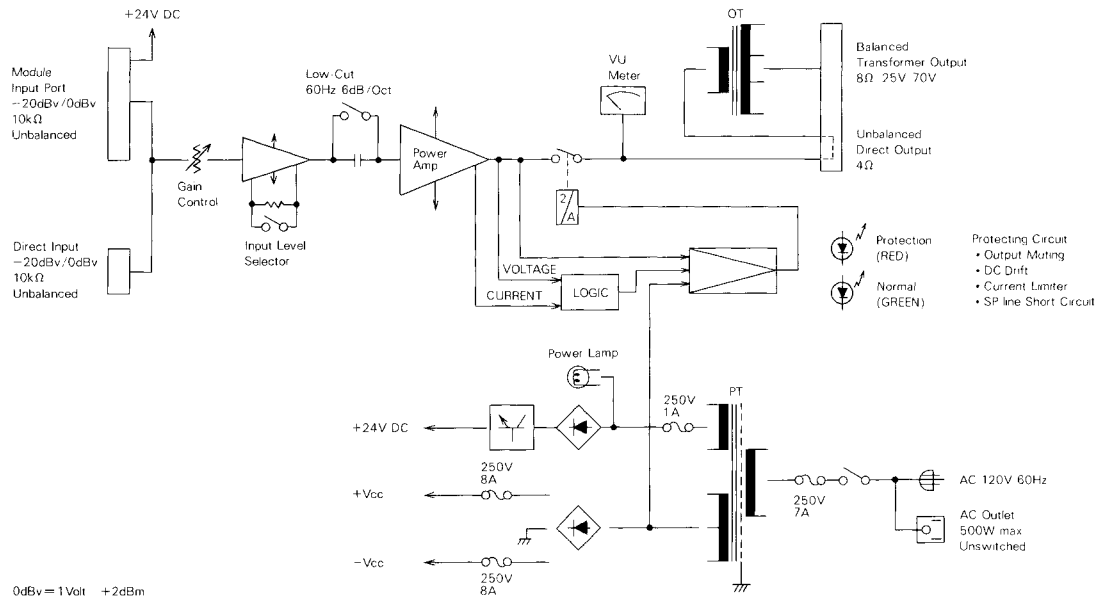

Plug-in Modules

(OPTION)

MODEL Connection	PLUG-CONNECTION			
	Balanced Connection	Unbalanced Connection	Input, Output Connection	Input, Output Connection
M-01 series M-11 M-51 series M-21 M-61 series B-01 Series B-11, L-01 Series L-11, L-41, T-01			U-21 U-61	T-02
 CANNON XLR-3-13 (Female) type	 CANNON XLR-3-12 (Male) type	 CANNON XLR-3-12 (Male) type	_____	_____
 CANNON XLR-3-14 (Male) type	 CANNON XLR-3-11 (Female) type	 CANNON XLR-3-11 (Female) type	_____	_____
 Phone Jack (P)	 Phone Plug (Double Pole)	 Phone Plug (Single Pole)	_____	_____
 RCA Phono Jack (R)	_____	 RCA Phono Jack	_____	_____
 3P Screw Terminal (S)	 Hot Common Earth	 Hot Earth	 Earth (Input) Hot Hot (Output) Earth	_____
 5P Screw Terminal (S)	 10K Potentiometer Hot Common Earth	 10K Potentiometer Hot Earth	 10K Potentiometer Earth (Input) Hot Hot (Output) Earth	 Hot (Input) Earth Earth Common (Output) Hot

The TOA PLUG-IN MODULES are suitable for TOA 900 SERIES MIXER POWER AMPLIFIERS A-901A, A-903A, A-906A, and A-912A MIXER PREAMPLIFIER M-900A, POWER AMPLIFIERS P-906A, P-912A, P-924A, and IN-WALL AMPLIFIERS W-906A, W-912A. Owing to wide selection of types of connectors can also meet the needs of equipment to be connected. MICROPHONE PREAMPLIFIER M-01 series, M-51 series, M-61 series, M-03, M-11 and M-21 incorporates controls for high-cut, low-cut and gain. A gain control is built in MAG. PHONO PREAMPLIFIERS R-01, and AUXILIARY PREAMPLIFIERS U-01 series, U-11 series, U-12, U-21 and U-61, LINE OUTPUT T-01 and AUX INPUT-LINE OUTPUT T-02.

M-61 and U-61 are built-in compressor circuit to protect the output level from distortion as a result of excessive input and keeps it constant.

M-51 series is built-in voice gate circuit to be automatically activated by presence of signal.

U-12 can adjust mute level.

T-01 series is an output module with transformer, serving as a line output for recording, etc...

A group of special signal generating modules is also available for catching-attention before announcement and testing within the total systems. ALL PLUG-IN MODULES have handles on their front for easy insertion and removal.

FEATURES

1. Wide dynamic range
2. Low noise and distortion
3. Wide frequency response
4. Built-in remote volume control circuit (M-21)
5. Built-in remote master volume or remote volume control circuit. (U-21)
6. Built-in muting circuit to mute incoming signal when MUTE TERMINAL is grounded, (available for modules having 10's in its model number such as U-11.)
7. Built in muting circuit to deliver or mute its output signal when MUTE TERMINAL is grounded. (M-11)
8. Built-in signal activated muting function (L-41)
9. Presettable gain control (except for B-01, B-11, L-01 and L-11)
10. Microphone modules furnished with tone controls (M-01, M-11, M-21, M-51, M-61, and M-03)
11. Built-in voice gate circuit (to be activated by input signals.) (M-51 series.)
12. All the microphone modules (except M-03) come with phantom power-ing capability.
13. Built-in compressor circuit (M-61, U-61)
14. Built-in variable muting circuit to adjust the muting level. (U-12)

Plug-in Modules

Applications			Specifications													Connector																						
			Module Types	Source Impedance	Input Sensitivity for Rated Output (100mV)	GAIN	Max. Before Clip into 10k-ohm load as less than 0.5% THD (1kHz) output voltage S-01, S-02, S-03	Frequency Response ±1dB	Noise level equivalent input noise or SN	Signal Muting Level	Remote volume control range Use 10K ohms potentiometer	Compress. Range [Threshold]	Power Requirement [24V DC]	Controls [Pre-settable]	Weight (max.)	XLR-3-13 (F)	XLR-3-14 (M)	Phone Jack (P)	RCA Phono Jack (R)	3P Screw Terminal (S)	5P Screw Terminal (S)																	
Microphone Preamplifier	*Low Z Gain Control	Mute or Mute	M-01 series	Balanced 200 ohms	nominal 1.0mV adjustable 0.25~2.5mV	nominal 40dB adjustable 52~32dB	6.3V (+16dBV)	25~20,000Hz	-126dBm 200 ohms terminated	60dB	0~-60dB	20dB Threshold Adjustable 0.5~5mV	9mA	1-Low Cut	110gr (3.88oz)	M-01F	M-01M	M-01P	—	M-01S	—																	
		14mA	1-High Cut										80gr (2.82oz)	—	—	—	—	M-11S	—																			
	30mA	1-Gain	90gr (3.17oz)										—	—	—	—	M-21S	—																				
	27mA	1-Low Cut 1-Sensitivity 1-Gain	110gr (3.88oz)										M-51F	—	—	—	M-51S	—																				
	33mA	1-Low Cut 1-High Cut 1-Threshold	110gr (3.88oz)										M-61F	—	—	—	M-61S	—																				
High Z, Gain Control, Low-cut & High-cut Filters	Compressor	M-61 series	Unbalanced 50K ohms	nominal 3.2mV adjustable 0.8~8.0mV	nominal 30dB adjustable 42~22dB	6.3V (+16dBV)	20~20,000Hz	S/N 70dB	—	—	—	9mA	1-Low Cut 1-High Cut 1-Gain	60gr (2.12oz)	—	—	M-03P	—	—																			
Mag. Phono Preamplifier	Gain Control		R-01	Unbalanced 50K ohms	nominal 2.0mV adjustable 2.0~5.0mV	nominal 34dB adjustable 34~26dB	6.3V (+16dBV)	RIAA Equalized	S/N 70dB	—	—	—	9mA	1-Gain	50gr (1.76oz)	—	—	—	R-01R	—	—																	
	Auxiliary Preamplifier	Gain Control	Mute	U-01 series	Unbalanced 220K ohms	nominal 100mV adjustable 100~3,200mV	nominal 0dB adjustable 0~-30dB	6.3V (+16dBV)	20~20,000Hz	S/N 90dB	Adjustable 0~-60dB	0~-60dB	20dB Threshold 1.0V	4mA	1-Gain	75gr (2.65oz)	U-01F	—	U-01P	U-01R	U-01S	—																
14mA			1-Mute Level 1-Gain	50gr (1.76oz)										—	—	—	U-11R	U-11S	—																			
27mA			1-Gain	50gr (1.76oz)										—	—	—	—	U-12S	—																			
27mA			1-Gain	60gr (2.12oz)										—	—	—	—	U-21S	—																			
30mA			1-Gain	55gr (1.94oz)										—	—	—	—	U-61S	—																			
Bridging transformer	—		B-01 series	Balanced 10K ohms	125mV	-1dB	—	20~20,000Hz	—	60dB	—	—	5mA	—	90gr (3.17oz)	B-01F	—	B-01P	—	B-01S	—																	
	with MUTE		B-11	Balanced 10K ohms	125mV	-1dB	—	20~20,000Hz	—	60dB	—	—	5mA	—	95gr (3.35oz)	—	—	—	—	B-11S	—																	
Line Matching Transformer	—		L-01 series	Balanced 600 ohms	125mV	-2dB	—	20~20,000Hz	—	60dB	—	—	8.5mA	1-Sensitivity	95gr (3.35oz)	—	—	—	—	L-01P	—	L-01S	—															
	with MUTE		L-11		125mV	-2dB	—																	—	—	—	—	—	—	—	—	—	—	—	—	—	—	—
	with Signal Activating MUTE		L-41		125mV Min. 15mV to activate mute function	-2dB	—																	—	—	—	—	—	—	—	—	—	—	—	—	—	—	—
Line Output			T-01	Output Balanced 600ohms	—	nominal 20dB (1.0V output) adjustable 20~4dB (1.0V~158mV)	6.3V (+16dBV) 4.7V (+13.4dBV) into 600 ohm load	30~20,000Hz	S/N 80dB	—	—	—	35mA	1-Gain	100gr (3.53oz)	—	—	—	—	—	T-01S	—																
Auxiliary Input Line Output			T-02	AUX	Unbalanced 220K ohms	nominal 100mV adjustable 100~1,000mV	nominal 0dB adjustable 0~-20dB	6.3V (+16dBV)	20~20,000Hz	SN 90dB	—	—	38mA	1-Input Gain	105gr (3.70oz)	—	—	—	—	—	—	T-02S																
				LINE OUT	Rated Output 1.0V	nominal 20dB (1.0V output) adjustable 20~4dB (1.0~158mV output)	6.3V (+16dBV) 4.7V (+13.4dBV) into 600 ohms load	30~20,000Hz	S/N 80dB	—	—	—	—	—	—	—	—	—	—	—	—	—	—															
Tone Signal Generator	1kHz Sine Wave		S-01	—	—	—	0.5V (-6dBV) 0.5% THD	—	S/N 80dB	—	—	—	7mA	1-Output	55gr (1.94oz)	—	—	—	—	—	S-01S	—																
	Buzzer/Yelp		S-02	—	—	—	1V peak to peak	—	S/N 80dB	—	—	—	11mA	1-Output	60gr (2.12oz)	—	—	—	—	—	S-01S	—																
	One Tone Chime Continuous Chime		S-03	—	—	—	1V peak to peak	—	S/N 80dB	—	—	—	16mA	1-Output	70gr (2.47oz)	—	—	—	—	—	S-03S	—																

*0 dBV = 1 volt = + 2 dBm. * Specifications are subject to change without notice.

FRONT PANEL CONTROLS AND FEATURES

Modules with built-in controls are provided in the following six types.

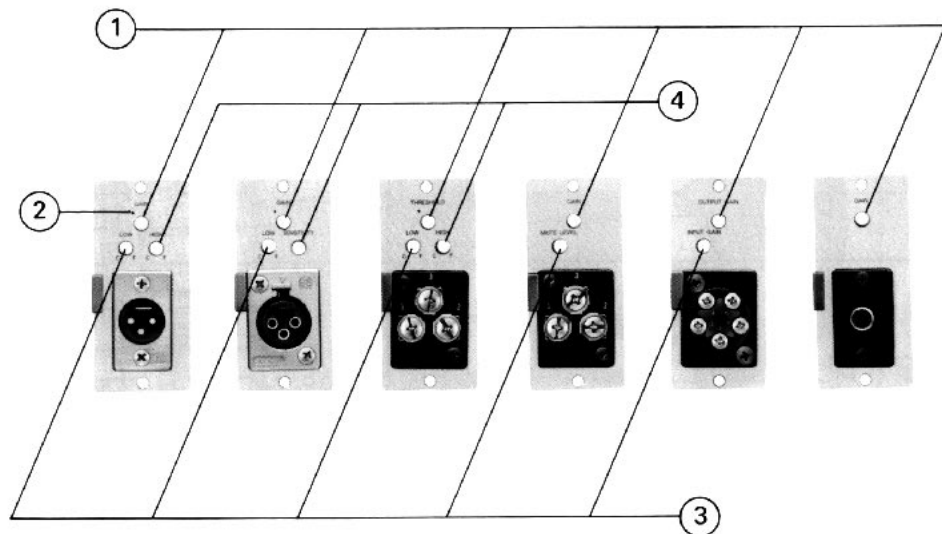

1 GAIN CONTROL

This adjusts gain. Turn clockwise (CW) to increase and counter-clockwise (CCW) to reduce gain.

Set the gain as low as possible, thereby, noise can be reduced, and the maximum permissible input level is raised.

This adjusts threshold level of compressor. Turn clockwise (CW) to reduce threshold level (to activate the compressor with lower input signal level).

THRESHOLD (M-61)

OUTPUT GAIN (T-02)

This adjusts gain of the line output. Turn clockwise (CW) to increase and counter-clockwise (CCW) to reduce gain regardless of setting position of the input gain adjust knob.

2 NOMINAL POSITION MARK

3 LOW-CUT FILTER CONTROL 330Hz, 6dB/oct (max. attenuation)

This provides flat characteristics at full CW position and attenuation in low frequency by turning CCW. Adjust it to obtain proper tone quality. With low-cut, tone becomes clear.

MUTE LEVEL (U-12)

This adjusts mute level. Turn clockwise (CW) to increase mute level (to be muted excessively) and counter-clockwise (CCW) to reduce mute level.

INPUT GAIN (T-02)

This adjusts input gain from AUX. Turn clockwise (CW) to increase gain and counter-clockwise (CCW) to reduce.

4 HIGH-CUT FILTER CONTROL 4.2kHz, 6dB/oct (max. attenuation)

This provides flat characteristics at full CW position and attenuation in high frequency by turning CCW. Adjust it to obtain proper tone quality. With high-cut, tone becomes soft.

SENSITIVITY (M-51)

This adjusts sensitivity for voice gate. Turn clockwise (CW) to increase sensitivity (to open the gate at full CW position regardless of any input level) and counter-clockwise (CCW) to reduce sensitivity.

SPECIFICATIONS IN COMMON

Load impedance	10k-ohms
Mounting	Card-edge connector
Dimensions in mm (inches)	78(3.07)x35(1.38)x88(3.46)
(H) x (W) x (D)	

CAUTION:

*Modules model M-11, U-11 and U-12 should be used exclusively with model A-901A, A-903A, A-906A, A-912A, M-900A, W-906A and W-912A.

Plug-in Modules

"Jumper Wire Setting"

M-01, 11, 21, 51, 61

All the microphone modules come with phantom powering capability. If not desired, cut J1 on the board.

U-21

Cut J2 on the board to use as a remote master volume control unit. Leave J2 on to use as a remote-control AUX module.

U-61

Cut J2 on the board to use as a compressor unit which goes between PREAMP OUT and POWER AMP IN (LINK IN/OUT).

M-11

Either (both) J3 or (and) J4 is (are) to be cut for a proper operation. Refer to the table below.

J3	J4	Function
on	on	No output signal
cut	on	Normally "Off", becomes "On" when muting terminals are closed.
on	cut	Normally "On", becomes "Off" when muting terminals are closed.
cut	cut	Works as a regular microphone input module.

^Z: Impedance Mute: Normally "On", becomes "Off" when muting terminals are closed.
Mute: Normally "Off", becomes "On" when muting terminals are closed.

Operation and Connections

(Plug-in Modules)

•S-01 (1,000Hz SINE WAVE)

CONNECTIONS

It is operated by closing the remote switch.

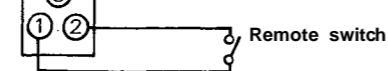

•S-02 (YELP AND BUZZER)

CONNECTIONS

Yelp signal

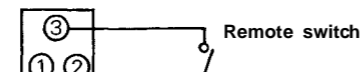

Buzzer signal



•S-03 (ONE-TONE CHIME AND CONTINUOUS ONE-TONE CHIME)

CONNECTIONS

One-tone chime

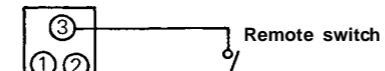

By closing the remote switch, chime sounds once.

Continuous one-tone chime



By closing the remote switch, one-tone chime sounds continuously during the closure of the switch.

Block Diagrams (Plug-in Modules)

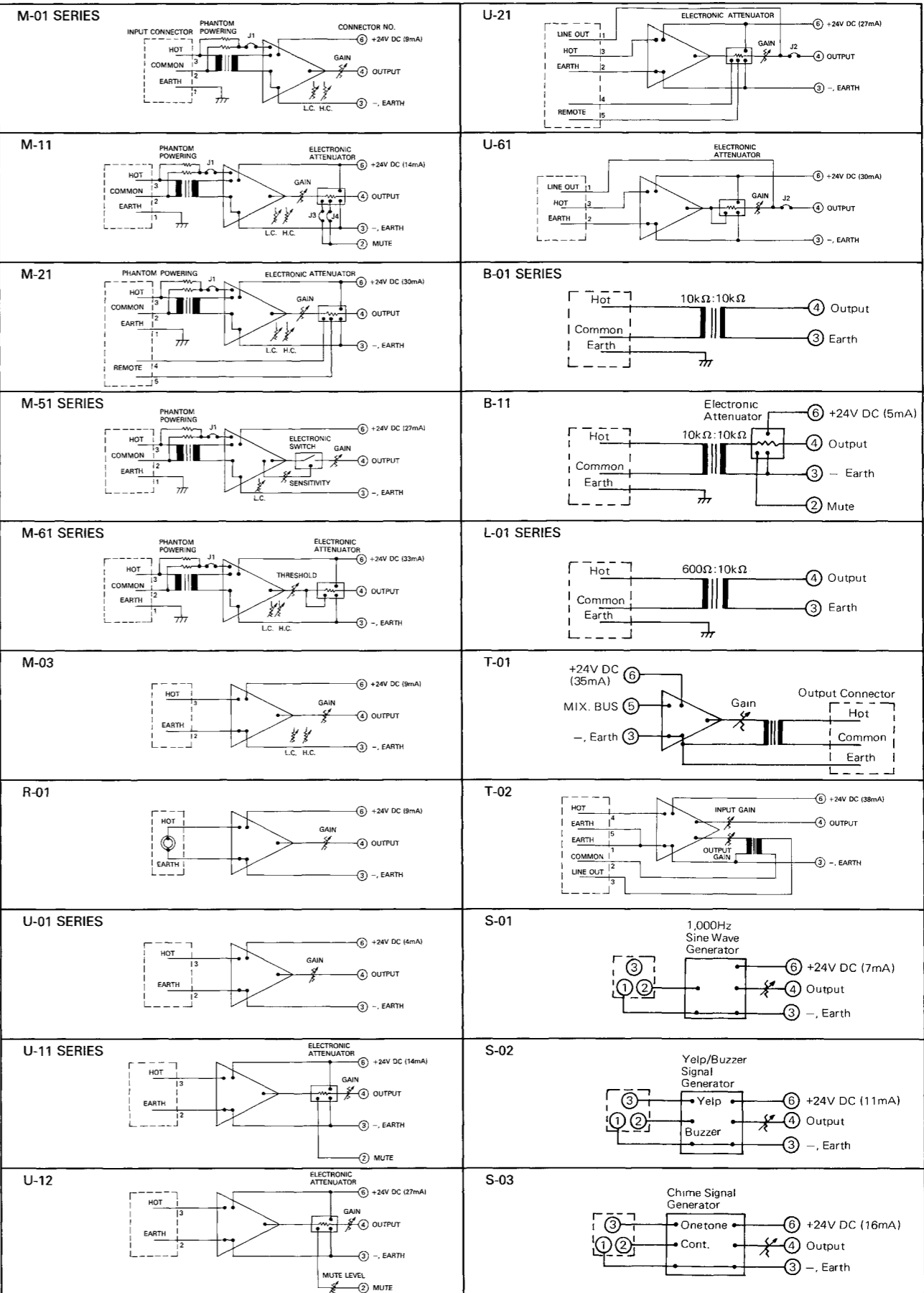

Accessories

Rack-mounting Brackets (Silver)

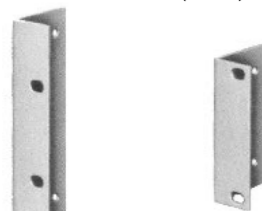

MB-931A MB-921

A-906A
A-912A
P-906A
P-912A
P-924A

M-900A
A-903A

Perforated Panel (Silver)



PF-911

Volume Control Cover

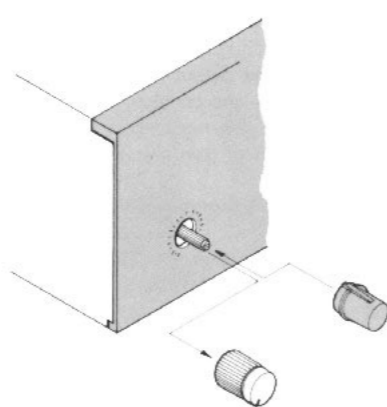

YA-910 (BLACK)

TOA 900 SERIES

Schematic P-924A

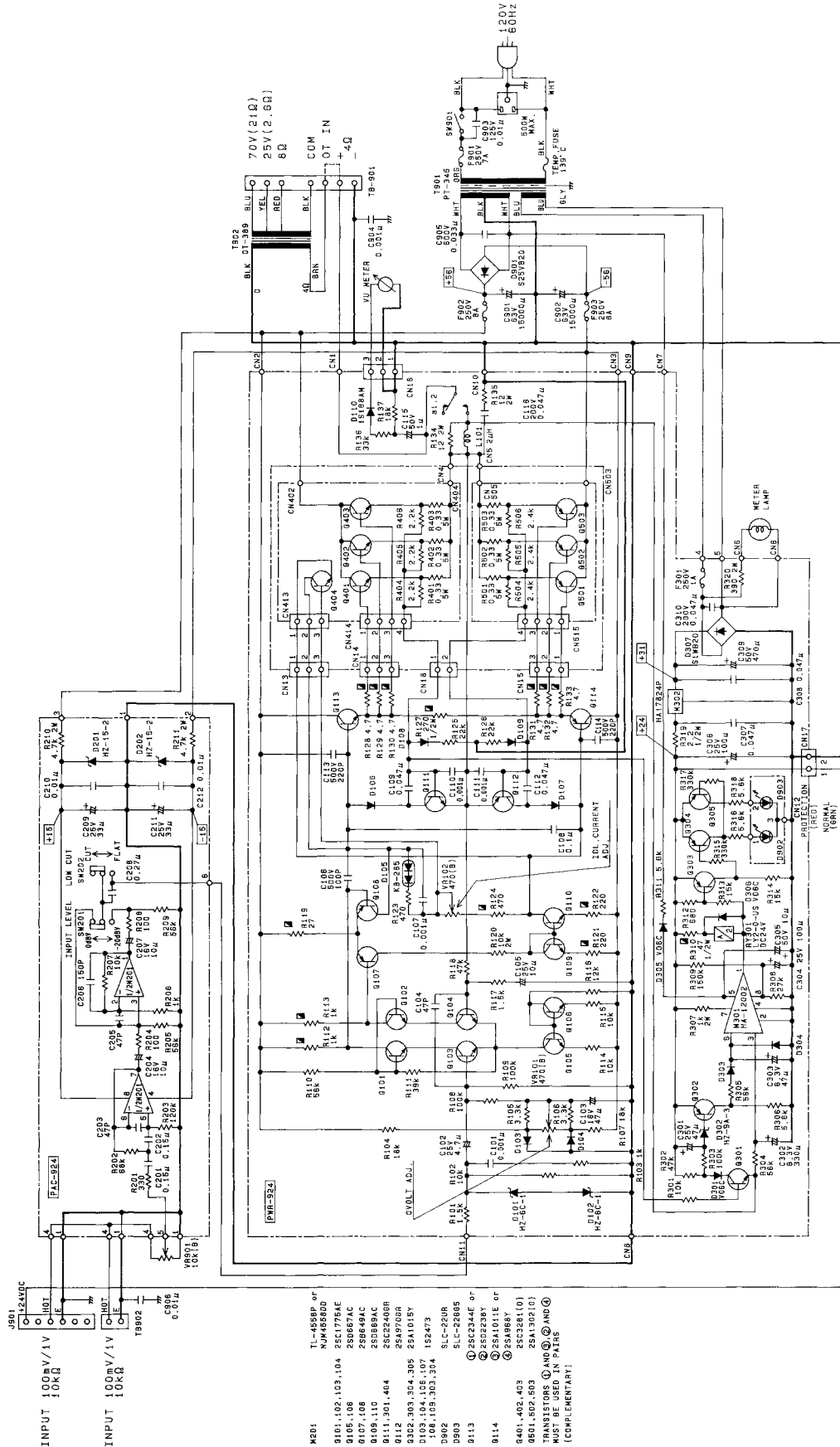

- M201** TL-4588P of
 NJM458600
 9101, 102, 103, 104 25C1775AE
 9105, 106 25D857AC
 9109, 108 25D889AC
 9111, 301, 404 25C22408R
 9112 25A8708R
 9302, 303, 304, 305 25A1015Y
 9103, 104, 105, 107 152479
 108, 109, 302, 304 SLC-2280R
 9902 SLC-2280S
 9903 SLC-2280S
 9113 Q25C234E of
 Q25C238Y of
 Q25A401E of
 9401, 402, 403 25C2281(0)
 9501, 502, 503 25A1302(0)
 TRANSISTORS (AN) AND (ND)
 MUST BE USED IN PAIRS
 (COMPLEMENTARY)

1. RESISTANCE VALUES IN OHMS.
2. ALL RESISTORS 1/4W UNLESS OTHERWISE DESIGNATED.
3. CAPACITANCE VALUES IN FARAD UNLESS OTHERWISE DESIGNATED.
4. VOLTAGES ARE MEASURED TO CHASSIS GROUND WITH NO SIGNAL.
5. ALL CAPACITORS 50V UNLESS OTHERWISE DESIGNATED.
6. ◻ NONFLAMMABLE RESISTOR.

