

# HAIER HWMP55-918 USER MANUAL



## Quick Links

[Parts](#)

[Preparation before Washing](#)

[Detergent](#)

[Operation](#)

[Maintenance](#)

[Trouble-Shooting](#)

## Table of Contents

[Table of Contents](#)

[Parts](#)

[Safety precautions](#)

[Installation and adjustment](#)

[Install the drain hose](#)

[Install the water inlet hose](#)

[Preparation before washing](#)

[Load the laundry](#)

[Detergent](#)

[Operation](#)

[Cycle completed](#)

[Maintenance](#)

[Trouble-shooting](#)

[Packing list](#)

[Specification](#)

[Other ManualsLib Projects](#)

## Fully Automatic Washing Machine User manual

# Haier

This manual is for  
HWMP55-918

- Please read this manual carefully before using.
- Retain it for future reference.

Haier



# CONTENTS

● CONTENTS.....	Inside cover
● Parts.....	1
● Safety precautions.....	2
● Installation and adjustment.....	4
● Install the drain hose.....	5
● Install the water inlet hose.....	6
● Preparation before washing.....	7
● Load the laundry.....	8
● Detergent.....	8
● Operation .....	9
● Cycle completed.....	13
● Maintenance.....	14
● Trouble-shooting.....	15
● Packing list.....	17
● Specification .....	Back page

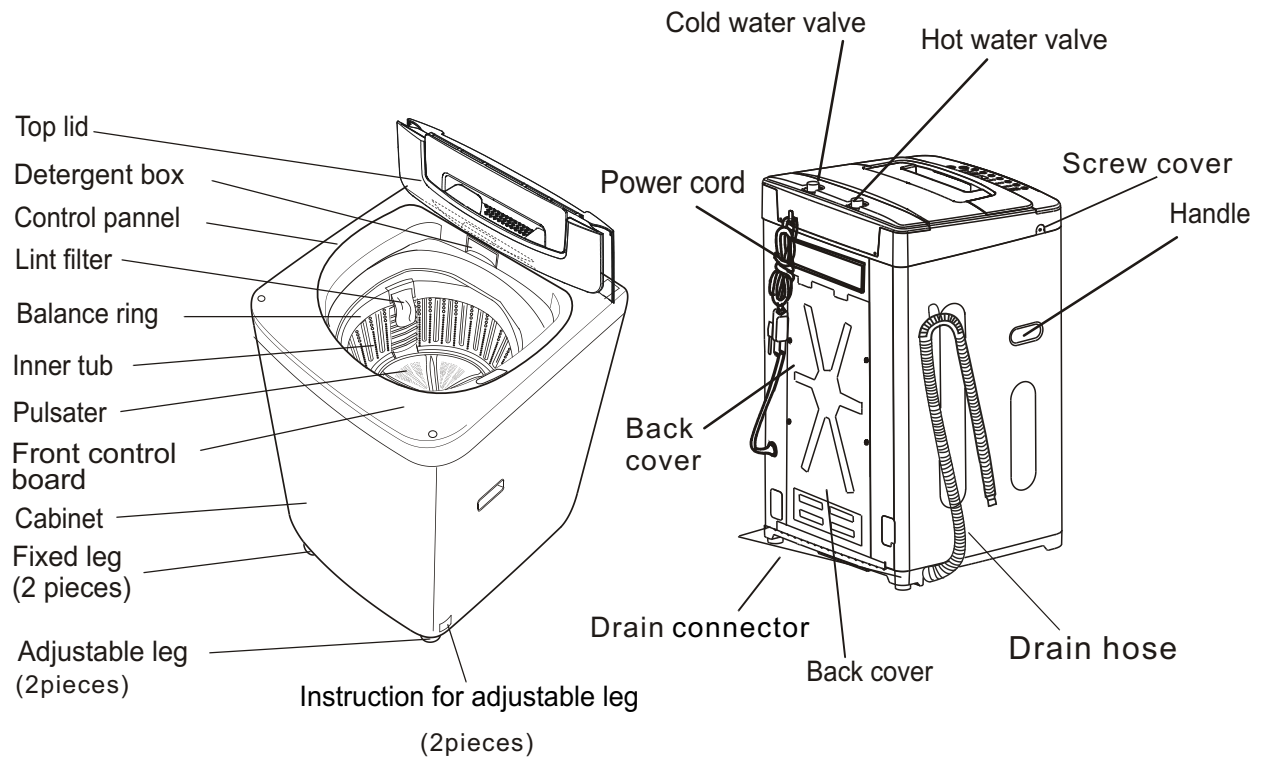
# Parts



## Meaning and description of symbols

<p>Warning sign</p> 	<p>Contents marked with this symbol are related to the safety of the product and the personal safety of the users. Please operate in strict conformity to the contents, otherwise it may cause damage of the machine or injure the personal safety of the user.</p>
<p>Forbidden sign</p> 	<p>Contents marked with this symbol are actions forbidden. Performing of those actions may result in damage of the machine or injure the personal safety of the user.</p>

Please check if power point has been earthed condition before using to guarantee your safety

# Safety precautions

A separate earthed socket is required for the power supply. Hold the plug not the electric cable when unplugging the washing machine. Do not insert or remove the power plug with wet hands.

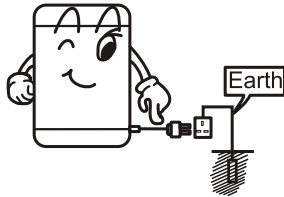

After installation of the washing machine, the power plug should be accessible. Ensure the plug is removed and the taps turned off in the following cases: power failure, cleaning, moving, installation and when not in use.



If the power cord is bad, to avoid risk it is required to replace it by the technicians of an after-sale service department. Keep the pin of the Power plug clean. If it is dusty, wipe with a dry cloth.



**CAUTION:** If this appliance is supplied from a cord extension set or electrical portable outlet device, the cord extension set or electrical portable outlet device must be positioned so that it is not subject to splashing or ingress of moisture.

Do not put the machine at damp place like a bathroom. Never wash it with water. Do not place wet laundry on the control panel.

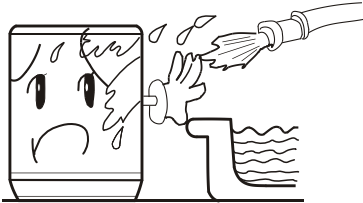

Do not use water hotter than 50°C.



Do not block the ventilation holes with carpet. Ensure carpet does not obstruct the opening in the base

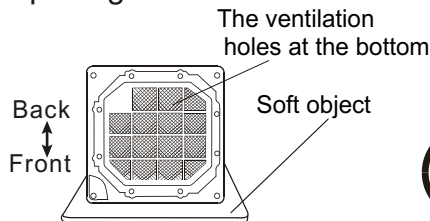

Do not wash water-proof laundry like raincoats and bike covers etc. to avoid abnormal vibrations in spinning.



A separate earthed socket is required for the power supply. Do not share the outlet with other appliances. If the plug is loose discontinue use. Do not use extension cords or portable outlet devices.

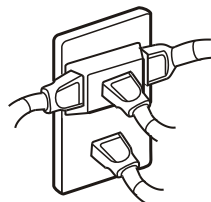

# Safety precautions

Do not put your hands into the working machine. It is dangerous even if the rotation is slow. Take special care of children.



Do not take apart, repair or alter the machine by yourself.



Do not put any hot or heavy items (such as a kettle with hot water) on the washing machine.



Do not wash laundry with volatile materials (such as thinner, petrol etc.).

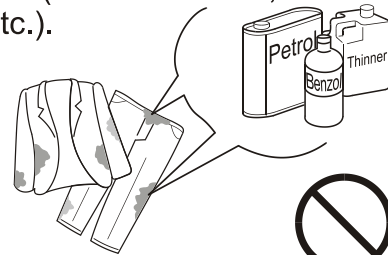

This appliance is not intended for use by persons (including children) with reduced physical, sensory or mental capabilities, or lack of experience and knowledge, unless they have been given supervision or instruction concerning use of the appliance by a person responsible for their safety. Children should be supervised to ensure that they do not play with the appliance.

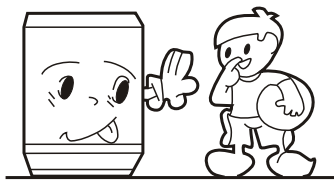

Keep the machine away from direct sunlight and heat source like a heater.

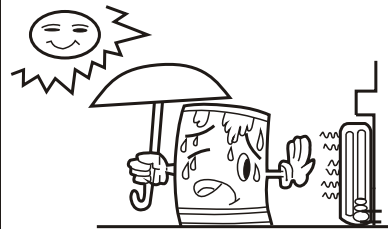

- If the supply cord is damaged, it must be replaced by the manufacturer, its service agent or similarly qualified persons in order to avoid a hazard.

- To protect your laundry and washing machine, please take out all coins, buttons, sand, hairpins and other foreign material before washing.



- Please check that the water faucet is open, and the water inlet pipe is connected correctly.
- Please use High Efficiency or Low Suds washing powder.

# Installation and adjustment

Please install and adjust the machine according to the requirement of the manual. It is very important to your safety and the correct operating the machine.

## Install the lint filter

After opening the package, please take out the lint filter from the document bag, install it to the inner tub. See the figure opposite.

- Please ensure the lint filter is installed correctly and in good condition to ensure the water outlet is not blocked or the flow altered. If the lint filter is lost please contact the local after-sales service department.

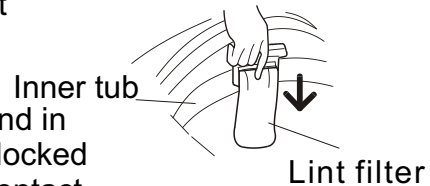

## Install the bottom plate

The purpose of the bottom plate is to block noise and give a quiet performance from the washing machine during operation.

Steps:

1. Lay the washer on its back.
2. Place the plate on to the bottom of the machine.
3. Use a screwdriver to tighten the screws securing the panel to bottom of the washer.
4. Once all screws are tight and the panel is secure return the washer to its standing position.

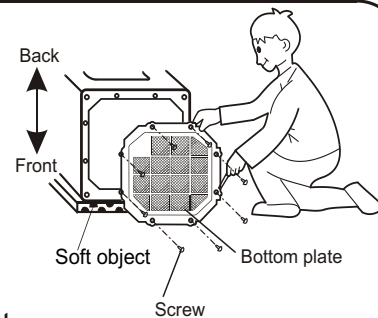

## Adjust the position

The largest allowable slope of the base of the machine is  $2^\circ$ . Slanting or rough ground will result in unstable running or stoppage of the machine. Please adjust it by the following method:

- Confirm it is level

- Adjust the adjustable leg:

1. To twist the adjustable leg, please first lift up the side of the leg slightly, loosen the adjustable nut, and twist the leg.
2. After adjustment, fasten the nut.

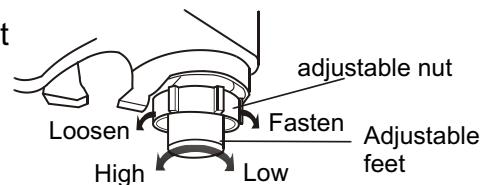
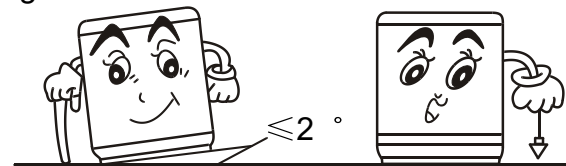

# Install the drain hose

## Install the drain hose

- First install the drain hose hook on the part of outer drain hose component.
- Put the drain hose clamp on the outer drain hose, Insert the outer drain hose into the joint for it, and then clutch tightly with drain hose hoop.

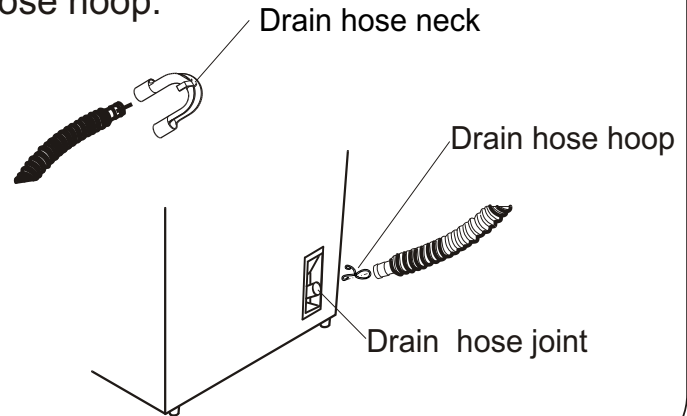

## 4-4. Usage of the drain hose

- Ensure the drain hose is mounted at a suitable height. (Between 800-1200mm above the floor).
- Do not push it too far down the drain pipe or siphoning will occur.

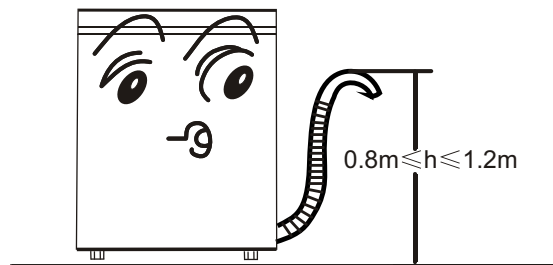

# Install the water inlet hose

## Install the water inlet hose

Use the new hose supplied, do not reuse old hoses.

1. Insert a new flat washer into each end of the inlet hose. Firmly put the washers in the coupling.

### Note:

- Use the new hose supplied with the washer. Any other old hoses should not be used.
- You may have to use pliers to tighten the coupling. Do not overtighten because you may cause damage to the valve.

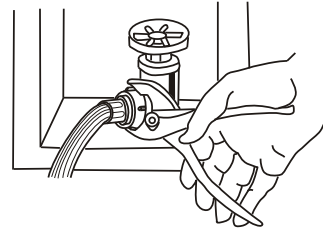

2. Connect the water inlet hose to the water faucet.
3. Connect the other ends to their respective cold and hot water inlet valve located at the rear of the washer

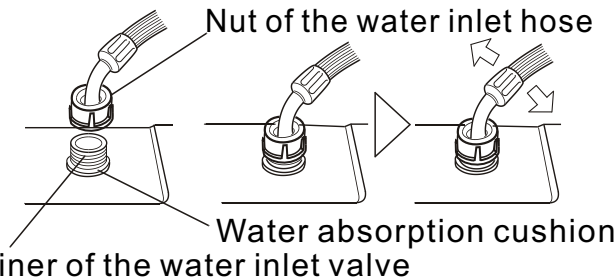

4. Fasten the nut. Swing the hose gently to confirm that the hose is securely fastened.

## Check the connection between the water inlet hose and the water tap

1. Swing the hose gently to confirm that the hose is securely fastened.
2. After installation, open the tap to check for leaks..
3. Do not bend the hose unduly.
4. Before every use check the hose connections are firm at both ends. This is to ensure the connections remain firm over time.



## Remove the water inlet hose

1. Close the water tap.
2. Remove the water inlet hose from the water tap and washer.

# 1. Preparation before washing





## Preparation before washing

Preparation before washing

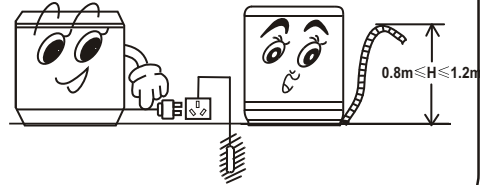
1. Connect the water inlet hose.
2. Inset the power plug into the electrical socket.
3. Ensure the drain hose is mounted at the correct height.
4. Select a suitable location for the washer on a hard, even surface away from direct sunlight or heat sources, e.g. radiators, cooking appliances etc.
5. Any floor unevenness may result in unstable working or abnormal noise. Please ensure the machine is level.

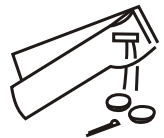
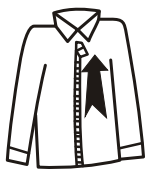

## Check the following before washing

<p>Check if the laundry has any special washing instructions</p>	<p>Clear the pockets. Take out loose items such as coins, sand, hairpins etc.</p>	<p>Tie any long strips, fasten buttons and close zippers.</p>	<p>The weight of the laundry shall not exceed the rated capacity. Loosen the laundry before placing it evenly in the tub.</p>	<p>When the machine is running buttons may cause noise. To reduce the noise turn clothes inside out or place them in a laundry bag.</p>
				
<ol style="list-style-type: none"> <li>a. Check if the laundry is suitable for machine washing.</li> <li>b. Divide the laundry into colour fast and non-colour fast items.</li> <li>c. Place items that do not absorb water easily into the water by hand.</li> <li>d. For heavily soiled items, please first remove loose dirt, then apply detergent directly to the stain before washing.</li> <li>e. For those items that may get lint or are furry or fluffy, please turn them inside out before washing</li> <li>f. Do not put laundry polluted by chemicals into the washing machine.</li> </ol>				

## 2. Load the laundry



- The rated washing capacity refers to the largest dry weight of a load that can be washed.
- The thickness, size and type of clothes will influence the actual capacity. Be careful to only load a reasonable amount of laundry.
- Do not select more than “4” water level for clothes less than 1.0kg, to avoid splashing of water
- It is suggested not to use high sudsing detergent. Choose a low suds or high efficiency detergent.

## 3. Detergent

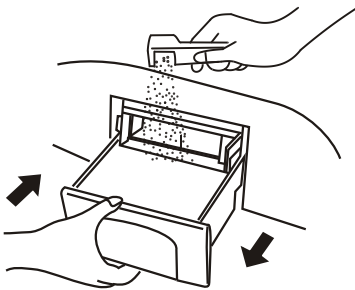

### Adding washing powder

#### How to use whitener

- Fill water to desired level. Dilute the whitener in a container. Pour it slowly into the washing tub.
- Avoid using whitener on laundry with color or pattern as they are prone to lose color.
- The whitener shall not touch the laundry directly.
- Refer to the whitener instructions for the usage and quantity.
- For powder whitener, please dissolve it before using .

- It is suggested to dissolve the detergent before you put them into the tub, see as below:

1. Prepare warm water of 35 °C and container.
2. Add washing powder while stirring to dissolve it completely.

- Add washing powder into the box directly under fuzzy program and reserve program.
- Dissolve directly inside the washing machine: (not applicable for fuzzy and reserve program)

1. Add some water (select the "L" water level)
2. Add washing powder. Run for about 30s to fully dissolve the powder. Then push the "start/pause" button.
3. Put in laundries. Select suitable water level. Push the "start/pause" button again.

- Please add suitable washing powder as per the laundries quantity, then set water level and water quantity.
- If you select save program, it is suggested to use liquid detergent instead of washing powder to guarantee the washing effect.
- It is not recommended to use rich-foam washing powder.
- Washing powder with poor quality or long-time storage may get caked. Please clean the detergent box periodically.

Note: For the better wash performance, please use lowing sudsing or high efficiency detergent and please dissolve the detergent in 1L warm water first

## 4. Close the lid

If you open the lid during spinning the machine will stop and an alarm will sound.

# 5 Operation

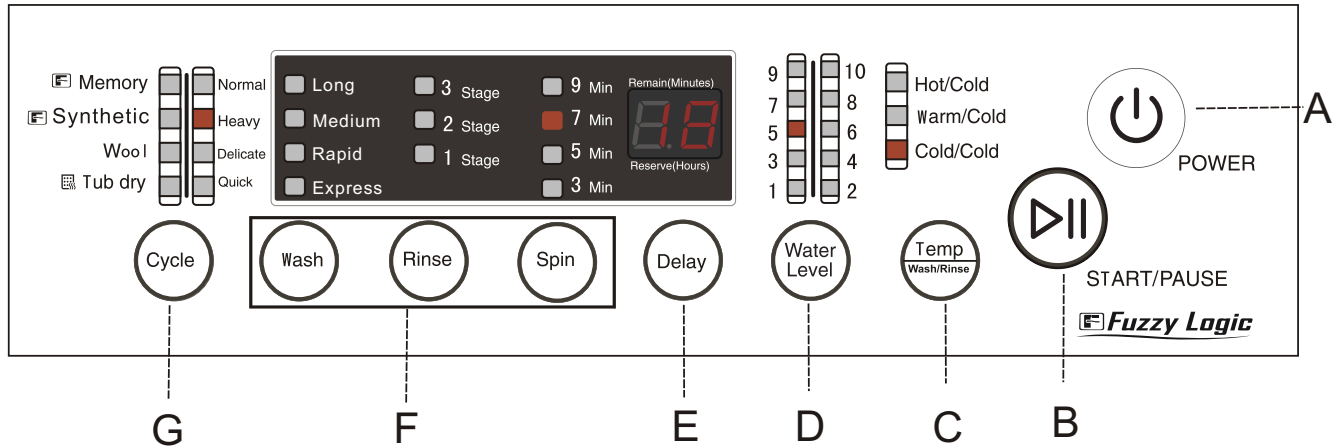

## Indicator display

- Off
- On: Indicates the program is about to run and indicates the selected cycle and options
- :□:Flashing: Indicates the program is running and indicates the selected cycle and options

## Remaining time display

- Displays "--" during detecting.
- Displays total remaining time during the running program(min).  
Displays remaining time when the "Delay" program is used (hours).
- Displays error codes (see page 12)

Page 12

## A "POWER" button

- Push the power button to switch on the power
- To turn off the power, press the power button.
- If the start pause button is not pushed within 5 minutes, the washing machine will automatically switch off the power.

## B "START/PAUSE" button

- After the power is switched on press the Start/Pause button to start the machine.
- During operation, push the Start/Pause button to pause the machine.
  - Push the Start/Pause button again to restart the machine.

## C "Temp(Wash/Rinse)" button

- Press the Temp(Wash/Rinse)" button to select your wash temperature.
- During quick cycle, the water temperature can't be chosen. Temp button does not work
- During wool cycle, the "hot/cold" water temperature can't be chosen.

#### D “Water Level” button

- During the Memory and Synthetic programs the washing machine will detect the size of the laundry and automatically select the water level between levels 4, 6, 8 or 10.
- To change the water level, press the Start/Pause button and make your selection. Press the Start/Pause button to start the machine, it will not set the water level automatically.
- If there is water inside the tub the machine cannot detect the laundry load and will display water level "6". If wet laundry is put in the machine, it will display level "3", the water level can be adjusted.
- If Quick program is selected, it will display water level “3” , the water level can be adjusted.
- If Tub Dry program is selected, the water level will not respond
- During operation of the wash, rinse or soak program, you can adjust the water level by pressing the Water Level button.
- The water level may vary due to the different moisture level of the laundry items.

#### E “Delay” button

- The display shows the time remaining (in minutes) before the cycle will finish.
- Push the "Delay" button and the display will show the remaining time for the cycle to finish (in hours). The indicator flashes to indicate that the delay function is operating.
- Delay start (2-24hr) option
- Delay time is the delay till the wash finishes.

#### F “Wash” “Rinse” “Spin” button

- You may change the Wash, Rinse and Spin times when Memory , Heavy Normal and Synthetic cycles are selected.
- When the Wool cycle has been selected you cannot change the Wash, Rinse and Spin times.
- You can not change the Wash Rinse and Spin times when Tub dry and Quick cycles are selected.



G “Cycle” button	
Program	Recommended for
Normal	Washing the Mixed fabrics laundry
Heavy	Items that are very dirty or items that are heavy or big
Delicate	Delicate items that are machine washable
Quick	Small load of lightly soiled laundry less then 1.5kg
Memory	The customer favourable cycle, it can remember the cycle setted this time(Water level will not be remembered because it will be setted by funzzy function). For example, you choose Memory cycle this time and then you set the wash time to Medium, rinse 2 times and spin time to 5min, next time when you choose Memory cycle, it will work as this time: Wash time: Medium, rinse 2 times and spin 5min.
Synthetic	Washing the Synthetic fabrics laundry
Wool	Machine washable woolen items
Tub dry	Drying the inner and outer tub to avoid the growth of mildew.

## Operation buttons and descriptions

### 1 Press the “” button to switch on the power

The machine has a power resume function. If the power fails the machine will save the current program and resume the same program once the power supply returns. The program does not need to be entered again.

### 2 Press the “” button to select automatic program

When the power is switched on "Normal" cycle is automatically set. To select a different automatic cycle, press the "Cycle" button till the corresponding indicator is on. Refer to the section on the "Cycle" button above.

E.g choose "Quick" cycle for a small load of lightly soiled laundry. When the "Synthetic", Memory cycles are selected the Fuzzy Logic program is run. The washing cycle is automatically set while the water level and wash time can be selected according to the texture and size of the load.

### 3 Press the buttons to customise the pre-set options

- Even there's no water in the tub, a certain period is required before spinning.
- Separate the laundries that are not colorfast from other laundries in washing.
- During wool cycle, you can not set the washing time, rinse times and spin time. You can only use the default settings.
- During rinsing ,you can only set the spinning time, and can not make setting in other cases
- During Quick, Tub Dry programs, press the Wash, Rinse,Spin button the machine has no reaction.

### 4 Press the button to change the water level

For the "Synthetic"and "Memory" cycles the machine will run the Fuzzy Logic program automatically detecting the type of laundry in the tub. After detection it will set the water level automatically. The water level can only be changed once the machine has started, push the "Start/Pause" button, then push the "Water Level" button to set the water level.

### 5 Press the button to select the the wash and rinse temperature

Press the “Temp/ (Wash/Rinse) ” button to select the the wash and rinse temperature

### 6 Press the button to select the delay wash program

The delay time program is automatically off. Select the Cycle and options required and push the "Delay" button

#### Confirm the operation of “Delay” program

- The cycle indicator lights will go off and the "Delay (Hours)" indicator light will be on. During the delay program, press the "Delay" button to display the time remaining. The delay time indicator shows the time remaining till the wash ends. To change or cancel the delay program, switch the power off and back on, then make a new selection.
- Delay start (2-24hr) option
- Delay time is the the end of washing



The wash will finish  
in about 18 hours



## 7 Press the “▶||” button to start the cycle

- If the top lid is opened when the machine is spinning, the machine will stop running and an alarm will sound.

### Note:

- The energy test program was performed using the "Normal" cycle default setting of: wash “long” , 1 rinse, spin 7 mins, water level 10.
- Please use low sudsing or high efficiency detergent.

## Cycle completed

After finishing washing, an alarm will sound. the washing machine will cut off the power automatically.

## 7 Maintenance

- Remove the power plug from the wall before cleaning.
- Clean the lint filter after each wash.

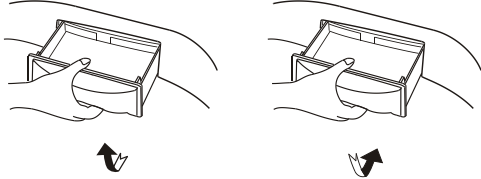
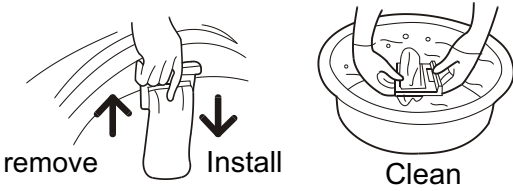
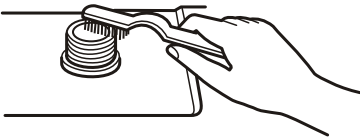
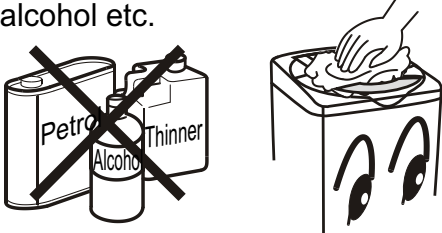
<p>Remove and clean the detergent box, replace after cleaning.</p>  <p>Dismantle      Install</p>	<ul style="list-style-type: none"> <li>• The lint filter must be used during washing.</li> <li>• It must be cleaned after each use</li> </ul> <p>Lint filter:</p> <ol style="list-style-type: none"> <li>1. Pull it up to remove it.</li> <li>2. Push it down to install.</li> <li>3. Clean the filter screen after each wash.</li> </ol>  <p>remove      Install      Clean</p>
<p>The filter screen of the water inlet valve may become to be blocked by foreign materials and influence the water inlet. Please clean it with brush every two months.</p> 	<p>If the cabinet is dirty, wipe it with a wet cloth</p> <ul style="list-style-type: none"> <li>• Do not wash it directly with water.</li> <li>• Wipe it with neutral detergent.</li> <li>• Do not wipe it with thinner, petrol, alcohol etc.</li> </ul> 

1. After washing, turn off the water faucet. ( If needed, you can remove the water inlet hose).
2. Do not store water in the washing machine for a long period. Drain the water completely .
3. Remove the power plug before carrying out any cleaning or maintenance.
4. Hang up the power cord and drain hose.
5. Wipe up any drops of water on the surface of the machine and inside the tub. Open the lid for about 1 hour , then close the lid.

# Trouble-shooting



If there is a breakdown, remove the power plug before checking the machine. Using the following list please confirm the machine requires repair. If repair is required please contact our Customer Care Team, do not try to fix it yourself.

Problem		Possible causes	What to do
The machine does not drain or drains slowly. The display shows E1.		<ul style="list-style-type: none"> <li>• Is the drain hose blocked?</li> </ul>	<ul style="list-style-type: none"> <li>• Remove the blockage. Open and close the top lid once.</li> </ul>
The machine stops running. The display shows E2.		<ul style="list-style-type: none"> <li>• The top lid is not closed.</li> </ul>	<ul style="list-style-type: none"> <li>• Close the top lid.</li> </ul>
The machine does not spin. The display shows E3.		<ul style="list-style-type: none"> <li>• Has the laundry been place unevenly in the machine?</li> <li>• Is the machine level?</li> </ul>	<ul style="list-style-type: none"> <li>• Redistribute the load evenly. Close the top lid.</li> <li>• Level the machine. The machine will start 10 seconds after being leveled correctly.</li> </ul>
The display will show E4 within 30 minutes		<ul style="list-style-type: none"> <li>• Is the water tap opened, or has the water supply been interrupted??</li> <li>• Is the water inlet valve blocked?</li> <li>• Is the water pressure too low?</li> </ul>	<ul style="list-style-type: none"> <li>• Open the water tap. Push the Start/Pause button once.</li> <li>• Clean the water inlet valve then push the Start/Pause button once.</li> <li>• Push the Start/Pause button once.</li> </ul>
The display shows E6.		<ul style="list-style-type: none"> <li>• The water level sensor has failed.</li> </ul>	<ul style="list-style-type: none"> <li>• Please contact the after-sales service department.</li> </ul>
The machine does not work.	Will not wash	<ul style="list-style-type: none"> <li>• Is there a power failure?</li> <li>• Is the power plug inserted tightly?</li> <li>• Has the water level reached preset position?</li> </ul>	<ul style="list-style-type: none"> <li>• Wait for the power supply to be restored.</li> <li>• Insert the power plug tightly.</li> <li>• Wait for water to fill to the preset level.</li> </ul>
	Will not spin	<ul style="list-style-type: none"> <li>• Is the power plug inserted tightly?</li> <li>• Is the top lid closed ?</li> <li>• Is the laundry distributed unevenly in the machine?</li> </ul>	<ul style="list-style-type: none"> <li>• Insert the power plug tightly.</li> <li>• Close the top lid.</li> <li>• Redistribute the laundry.</li> </ul>
There are abnormal sounds inside the machine		<ul style="list-style-type: none"> <li>• Is the machine level?</li> <li>• Has the laundry been place unevenly in the machine?</li> <li>• Are there any foreign objects inside the bowl?</li> </ul>	<ul style="list-style-type: none"> <li>• Redistribute the load evenly. Close the top lid.</li> <li>• Level the machine.</li> <li>• Remove the foreign object.</li> </ul>
The water tap leaks		<ul style="list-style-type: none"> <li>• Is the water inlet hose loose?</li> </ul>	<ul style="list-style-type: none"> <li>• Fasten the inlet hose.</li> </ul>

## Common occurrences

Situation	Cause
<ul style="list-style-type: none"><li>• The spinning is intermittent when it starts.</li></ul>	<ul style="list-style-type: none"><li>• Redistribute the load evenly. Close the top lid.</li></ul>
<ul style="list-style-type: none"><li>• The wash procedure pauses.</li></ul>	<ul style="list-style-type: none"><li>• <b>The cloth sensor is detecting , it will add water after about 48 senconds.</b></li></ul>
<ul style="list-style-type: none"><li>• Select spin program, but it does not work.</li></ul>	<ul style="list-style-type: none"><li>• The program is setting the drain time a period of time is needed before the spin program starts.</li></ul>
<ul style="list-style-type: none"><li>• There maybe water in the drain hose in when first used.</li></ul>	<ul style="list-style-type: none"><li>• It is the water remaining after the performance inspection by the factory.</li></ul>

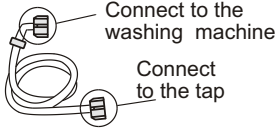
# Packing list

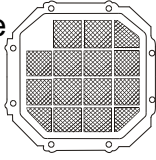
Name	Quantity	Storage position
● User manual	● One	● Inside the document bag
● Warranty card	● One	● Inside the document bag
● Components of the water inlet hose 	● Two	● Inside the accessory bag
● Lint filter 	● One	● Inside the document bag
● Tapping screws 	● Eight	● Inside the accessory bag
● Bottom plate 	● One	● Between the upper cushion of the washing machine package and the upper seal of the package carton.
● Automatic washing machine	● One	
● Drain hose	● One	● Inside the accessory bag
● Drain hose hook	● One	● Inside the accessory bag
● Drain hose clamp	● One	● Inside the accessory bag

# Specification

Type	Fully Automatic Washing Machine
Model	HWMP55-918
Rated voltage/frequency	220-240V~ 50Hz
Rated washing power	380W
Rated spinning power	300W
Weight	About 35kg
Dimensions (mm)	L 520 W 530 H 900
<b>Water level/Water quantity(about)</b>	1/14 L 2/18L 3/22L 4/26L 5/30L 6/34L 7/38L 8/43L 9/47L 10/52L
Water inlet pressure	0.03MPa-1.0MPa (when water temperature is 70°C, the water inlet pressure of hot water shall not exceed 0.4MPa)

# Other ManualsLib Projects



[www.manualslib.com](http://www.manualslib.com)



[www.manualslib.de](http://www.manualslib.de)



[www.manualslib.es](http://www.manualslib.es)



[www.manualslib.fr](http://www.manualslib.fr)



[www.manualslib.nl](http://www.manualslib.nl)



[www.manualslib.mx](http://www.manualslib.mx)



[www.manualslib.tech](http://www.manualslib.tech) 30+ Languages