

THE *General Radio* EXPERIMENTER



VOLUME XVII No. 5

OCTOBER, 1942

ELECTRICAL MEASUREMENTS AND THEIR INDUSTRIAL APPLICATIONS

<i>Also</i>	
IN THIS ISSUE	
	Page
PERIODIC MAINTENANCE WILL KEEP THEM IN SERVICE.....	8

FREQUENCY CHARACTERISTICS OF DECADE CONDENSERS

● IT HAS BEEN CUSTOMARY IN THE PAST to think of the capacitance and dissipation factor of decade condensers, such as the TYPE 219 Decade Condensers and the TYPE 380 Decade-Condenser Units of which they are composed, as fixed quantities independent of frequency, at least to their stated

accuracy. This is by no means the case and, since decade condensers are now being used over increasingly wide frequency limits, it becomes important to know the limits within which these condensers may be safely used.

The general way in which both capacitance and dissipation factor vary with frequency is shown by the various curves of Figure 6. There is always a minimum, but the increases at the high and low ends are produced by quite different causes. The low frequency rise is caused by dielectric polarization, a property of the solid dielectric of which the condensers are made, while the high frequency rise comes from the effect of the residual impedances in the leads from the terminals through the switches to the individual mica or paper condensers. Each of these causes will be discussed in considerable detail, first for TYPE 380 Decade-Condenser Units and then for TYPE 219 Decade Condensers.

FIGURE 1. Panel view of a TYPE 219-M Decade Condenser.



IET LABS, INC in the GenRad tradition
534 Main Street, Westbury, NY 11590

www.ietlabs.com
TEL: (516) 334-5959 • (800) 899-8438 • FAX: (516) 334-5988

DIELECTRIC POLARIZATION

The behavior of any dielectric as the frequency is varied depends upon the polarization existing in that dielectric. There are two distinct kinds of polarization, dipole and interfacial. Dipole polarization, as first described by Debye, occurs in dielectrics having polar molecules. In an alternating electric field these dipoles tend to oscillate with the field and the degree with which they succeed determines the increase in dielectric constant and capacitance. The way in which this increase occurs as the frequency is decreased is shown in Figure 1.¹ Dissipation factor also increases at first but reaches a maximum and then decreases in a symmetrical curve. Interfacial polarization, first described by Maxwell, occurs in composite dielectrics. The heaping up of the charged carriers, ions or electrons, at the interfaces of the components during each alternation of the electric field, serves to increase the dielectric constant and capacitance just as effectively as the oscillation of the dipoles. In fact the two types of polarization cannot be distinguished by the way either dielectric constant or dissipation factor varies with frequency. In that respect they differ only in the frequency ranges in which they occur, as indicated roughly in Figure 2. Interfacial polarization has

¹E. J. Murphy and S. O. Morgan, *The Dielectric Properties of Insulating Materials*, Bell System Technical Journal, Vol. 16, Oct. 1937, pp. 493-512.

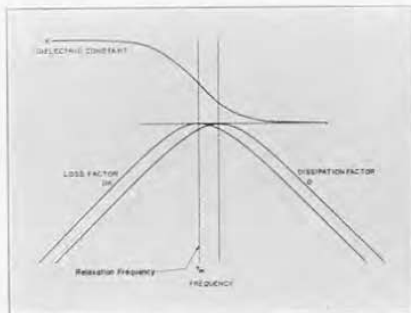

FIGURE 3. Change of dielectric constant, loss factor, and dissipation factor with frequency for a single polarization.

also been called dielectric absorption and volume charge, these names being particularly appropriate when referring to the fact that the total charge stored in such a dielectric by the long-time application of a steady voltage can be several times that expected from the audio-frequency dielectric constant.

The frequency at which maximum loss factor² occurs, called the relaxation frequency, and the rates at which both loss factor and dielectric constant change with frequency depend on the kind of polarization, the kind of dielectric, and the temperature. For mica there is no dipole polarization and the relaxation frequency for its interfacial polarization is well below 1 cycle. The interfacial relaxation frequency for paper is also well below 1 cycle. Paper has also a dipole polarization in the neighborhood of 100 Mc, which is of little consequence be-

²Dissipation factor $D = \frac{R}{X}$; loss factor = DK , where K is the dielectric constant.

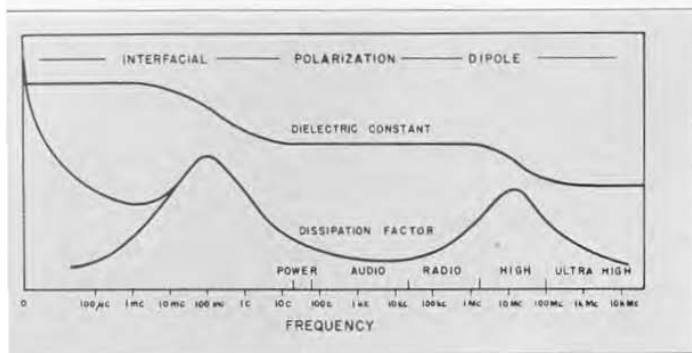

FIGURE 2. Typical curves showing how dielectric constant and dissipation factor change with frequency due to dielectric polarization (after Murphy and Morgan). The upper branch of the dissipation factor curve shows the effect of d-c conductivity.

cause paper condensers are rarely used at high frequencies. The use of wax or mineral oil for impregnation adds little to the polarization. Some of the recent synthetic oils, particularly those containing chlorine, have dipole polarizations with relaxation frequencies around 1 Mc.

The exact shapes of the curves of Figure 2 are shown in Figure 3, where frequency, loss factor, and dissipation factor are plotted logarithmically and dielectric constant arithmetically. At the relaxation frequency f_m , where loss factor is a maximum, dielectric constant is changing at the greatest rate and has a value just half way between its low and high frequency values. The shoulders of the loss factor and dissipation factor curves at a considerable distance from the relaxation frequency are linear. Similarly, a plot of the fractional increase in dielectric constant, expressed in terms of the total increase, at frequencies considerably higher than the relaxation frequency is also linear. The slopes of the shoulders of both of these lines are equal.³

Representative values for the four different kinds of TYPE 380 Decade-Condenser Units are shown by the lines of Figure 4, which start down from the left. In the case of dissipation factor this

³The slopes are related to the depression angle of the center of the circular arc obtained by plotting loss factor against dielectric constant.^{1,2} The theories of both Debye and Maxwell demand that such a plot result in a semicircle with its center on the dielectric constant axis. The fact that data obtained from all solid and most liquid dielectrics is well represented by a circular arc with depressed center was pointed out by K. S. and R. H. Cole^{1,2} in 1941.

⁴K. S. and R. H. Cole, Dispersion and Absorption in Dielectrics, *Journal of Chemical Physics*, Vol. 9, Apr. 1941, pp. 341-351.

⁵R. F. Field, The Basis for the Non-destructive Testing of Insulation, *AIEE Transactions*, Vol. 60, Sept. 1941, pp. 890-895.

⁶W. Kauzmann, Dielectric Relaxation as a Chemical Rate Process, *Reviews of Modern Physics*, Vol. 14, Jan. 1942, pp. 12-44.

FIGURE 4. Components of fractional capacitance and dissipation factor as a function of frequency. The lines slanting down from the left come from interfacial polarization, those slanting up to the right come from residual inductance and resistance.

would imply very low values at high frequencies. Actually for mica and other low loss dielectrics, such as quartz and polystyrene, there appears to be an underlying polarization which provides an almost constant dissipation factor. The dipole polarization in paper causes a minimum in dissipation factor beyond which, at higher frequencies, the dissipation factor rises.

RESIDUAL IMPEDANCE

At high frequencies the small inductance and resistance of the leads of a solid dielectric condenser produce an increase in its apparent capacitance and dissipation factor.^{7,8,9} The fractional increase in capacitance of the circuit shown in Figure 5, which represents this case, is

$$\frac{\Delta C}{C} = \frac{\omega^2 LC}{1 - \omega^2 LC} = \omega^2 LC \text{ approx.} \quad (1)$$

⁷R. F. Field and D. B. Sinclair, A Method for Determining the Residual Inductance and Resistance of a Variable Air Condenser at Radio Frequencies, *Proceedings of the Institute of Radio Engineers*, Vol. 24, Feb. 1936, pp. 255-274.

⁸D. B. Sinclair, Parallel-Resonance Methods for Precise Measurements of High Impedances at Radio Frequencies and a Comparison with Ordinary Series-Resonance Methods, *Proceedings of the Institute of Radio Engineers*, Vol. 26, Dec. 1938, pp. 1466-1497.

⁹D. B. Sinclair, The Behavior of TYPE 505 Condensers at High Frequencies, *General Radio Experimenter*, Vol. 12, Apr. 1938, pp. 4-8.

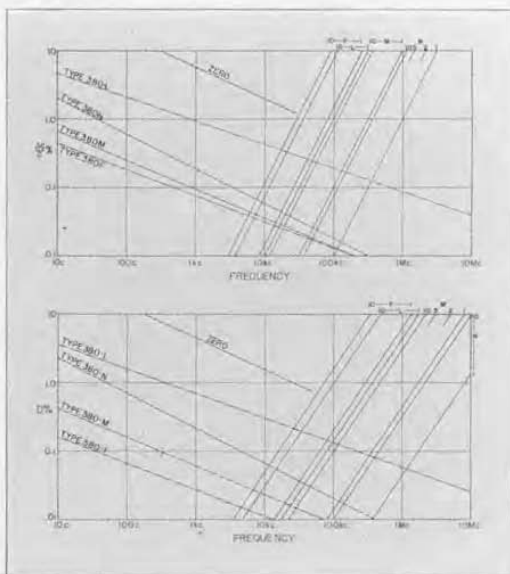

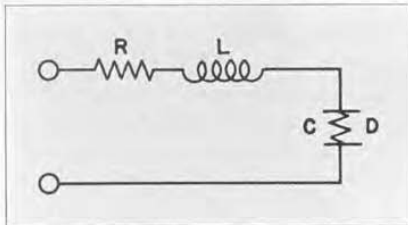

FIGURE 5. The residual impedances L and R are in series with the solid dielectric condenser having a capacitance C and dissipation factor D .

The fractional increase in capacitance varies as the square of the frequency. The increase in dissipation factor is

$$\Delta D = R\omega C \quad (2)$$

But the actual value of resistance to be used is the a-c resistance at a given frequency, not the d-c resistance. The leads are usually of sufficient diameter so that all the current flows on the surface.¹⁰ Under this condition the resistance in-

¹⁰H. A. Wheeler, Formulas for the Skin Effect, *Proceedings of the Institute of Radio Engineers*, Vol. 30, Sept. 1942, pp. 412-424.

increases with the square root of the frequency,

$$R = R_1\sqrt{f} \quad (3)$$

where R_1 is the resistance at unit frequency, usually 1 Mc. Hence

$$\Delta D = 2\pi R_1' f^{3/2} C \quad (4)$$

where R_1' is the value that the resistance would have at a frequency of 1 cycle, if the square law held to that frequency. Thus, the increase in dissipation factor varies as the three-halves power of the frequency.

Representative values of the residual impedances for the first four steps of a TYPE 380 Decade-Condenser Unit are 0.25 μ h and 0.07 Ω at 1 Mc for the L , M , and N types and 0.35 μ h and 0.01 Ω for the F type. The d-c resistance of the switch is only about 0.02 Ω , so the skin effect ratio at 1 Mc is 3.8. This corresponds to a No. 18 copper wire. The increases in capacitance and dissipation

factor caused by these residuals are shown by the lines slanting upward on the right in Figure 4. The complete frequency characteristics of these decade condensers are the sums of the slanting lines for capacitance and dissipation factor, as shown by the curves in Figure 6.

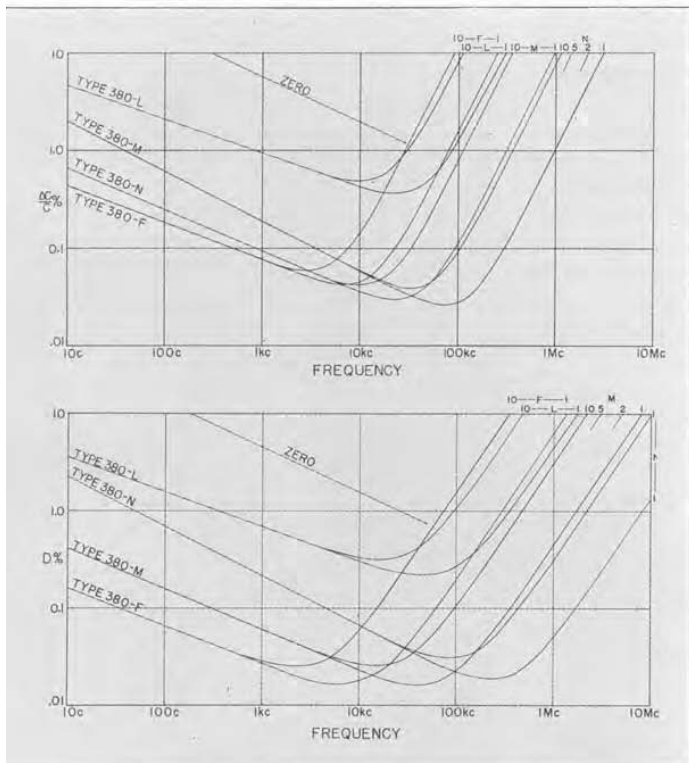

FIGURE 6. Frequency characteristics of TYPE 380 Decade Condenser Unit for switch positions 1 and 10, obtained by adding the components shown in Figure 4. The distribution of the curves for the other switch positions is shown for the TYPE 380-N Unit. The curves for the zero capacitance are shown in the upper left corner of each plot.



CONDENSERS IN PARALLEL

In a TYPE 380 Decade-Condenser Unit four separate condensers are successively connected in parallel groups by means of the drum switch shown in Figure 7 to give the ten steps of a decade. The four units have capacitances in the ratio 1 : 2 : 3 : 4, giving the first four steps directly and are then combined in the manner shown in Table I to give the other steps. For the small values of dissipation factor which these condensers have, capacitances add directly,¹¹ while dissipation factor is calculated from the rule that the products, dissipation factor times capacitance, add.¹²

$$C = C_1 + C_2 + \dots = \Sigma C$$

$$D = \frac{D_1 C_1 + D_2 C_2 + \dots}{C_1 + C_2 + \dots} = \frac{\Sigma(DC)}{\Sigma C} \quad (5)$$

To a good approximation all four units have the same dissipation factor, which thus becomes the value for all settings. Limiting values of the *DC* products for the various decades are given in Table II.

The TYPE 380 Switch and the wiring to the four condensers has a capacitance of about 11 μf . This is the zero capacitance of the switch and must be added to the sum of the capacitances of the condensers used at any setting to get the total capacitance. The dissipation factor of this zero capacitance is about 0.05 at 1 kc, thus giving a *DC* product of 0.55

TABLE I

Step	Units Used	L/L_C and R/R_C
1-4	1 to 4	1.000
5	4 + 1	.680
6	4 + 2	.556
7	4 + 3	.510
8	4 + 3 + 1	.406
9	4 + 3 + 2	.358
10	4 + 3 + 2 + 1	.300

¹¹Actually there are mutual capacitances among the four units which are successively shorted by the switch in its different positions. This causes the actual capacitance to be less than the sum of the separate capacitances. This difference is small and is significant only in the TYPE 380-N Decade.

¹²Note the analogy with loss factor which is dissipation factor times dielectric constant.

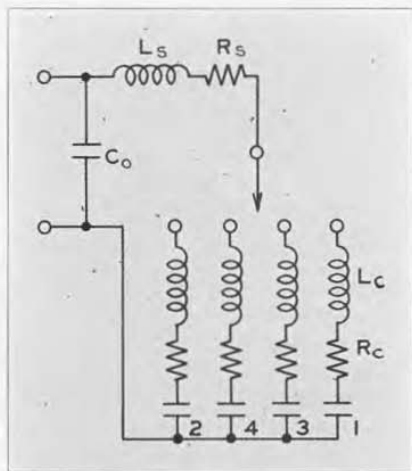
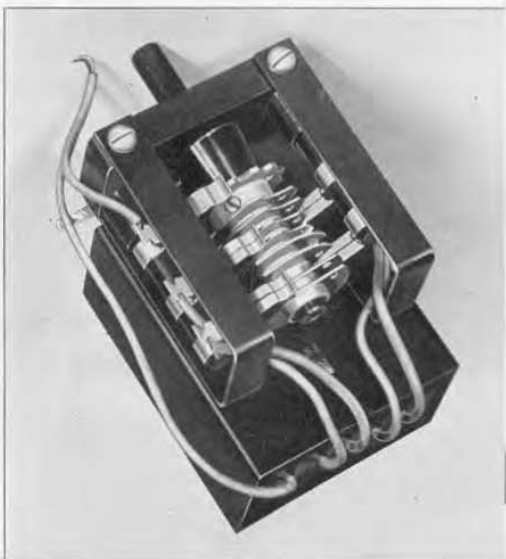

FIGURE 8. Schematic diagram of a TYPE 380 Decade Condenser Unit showing the residuals L_C and R_C associated with the separate condensers, residuals L_S and R_S of the leads, and the zero capacitance C_0 with its dissipation factor D_0 .

μf . This is sufficiently large so that it must be included in calculating the dissipation factor for all settings of the TYPE 380-N Unit and the first several settings of the TYPE 380-M Unit. The

FIGURE 7. View of a TYPE 380 Decade Condenser Unit showing the switch and the metal container which holds the condensers.



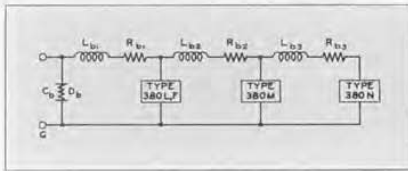

FIGURE 9. Schematic diagram of a TYPE 219 Decade Condenser, showing the added residuals L_B and R_B of the leads to the TYPE 380 Units and the added zero capacitance C_P and D_P .

variation with frequency of both the zero capacitance and its dissipation factor is shown in Figure 6.

The residual impedances of a TYPE 380 Decade-Condenser Unit are divided in the manner shown in Figure 8. Each condenser has the residuals L_C and R_C in its own leads to the switch, with the residuals L_S and R_S common to all for the L , M , and N types. Approximate values of these residuals are $0.10 \mu\text{h}$ and $0.15 \mu\text{h}$ for the inductances and 0.03Ω and 0.04Ω at 1 Mc for the resistances, respectively. Actually, because the leads from switch to condensers are of different lengths, the residuals L_C and R_C for the four condensers differ slightly. For a particular switch the measured values for the four lead inductances were 0.100 , 0.076 , 0.095 , $0.076 \mu\text{h}$ in the order 1, 2, 3, 4. These values follow roughly the areas embraced by the leads as shown in Figure 7. These differences are not significant and it will be sufficient to use the

rounded value $0.10 \mu\text{h}$. There are also similar small differences in the resistance values. The residuals for the F type are $0.10 \mu\text{h}$ and $0.25 \mu\text{h}$, 0.03Ω and 0.07Ω .

When capacitances with residual impedance are connected in parallel, the impedances add according to the following rules:

$$L = \frac{L_1 C_1^2 + L_2 C_2^2 + \dots}{(C_1 + C_2 + \dots)^2} = \frac{\Sigma(LC^2)}{\Sigma^2 C} \quad (6)$$

$$R = \frac{R_1 C_1^2 + R_2 C_2^2 + \dots}{(C_1 + C_2 + \dots)^2} = \frac{\Sigma(RC^2)}{\Sigma^2 C}$$

When the residuals are all equal,

$$L = L_C \frac{\Sigma C^2}{\Sigma^2 C} \quad (7)$$

$$R = R_C \frac{\Sigma C^2}{\Sigma^2 C}$$

which yield the ratios L/L_C and R/R_C for the ten positions of the switch given in Table I. For this case the residuals at maximum capacitance are only three-tenths of their values at minimum capacitance. The effect of this change in the apparent value of the residuals on the capacitance change and dissipation factor of the various TYPE 380 Units is shown in Figure 5. Curves for the maximum and minimum capacitance settings are shown for all four TYPE 380 Units.

TYPE 219 DECADE CONDENSERS

When several TYPE 380 Decade-Condenser Units are assembled to form a

TABLE II

Decade	Material	Case	C μf	DC μmf
F	Mica	505	.1 -1.0	20-200
M	Mica	Moulded	.01 - .1	5-50
N	Mica	Moulded	.001- .01	1-10
L	Wax paper		.1 -1.0	500-5000

TABLE III

Position	Unit	L μh	R at 1Mc Ω	L μh	Total R at 1Mc Ω
1	380-F & L	.16	.025	.16	.025
2	380-M	.10	.015	.26	.040
3	380-N	.10	.015	.36	.055



TYPE 219 Decade Condenser, a zero capacitance common to all the units and residual impedances between the units is added as shown in Figure 9. The largest unit is placed next to the terminals and, therefore, has the smallest residual impedances. The added zero capacitance is about $8 \mu\text{mf}$ with a dissipation factor of about 0.05 at 1 kc. Their variation with frequency is the same as those of the separate units as shown in Figure 5. It is most convenient to add together all of the zero capacitances, for the box and for the three units. This gives a total of $41 \mu\text{mf}$ for the TYPE 219-M and $46 \mu\text{mf}$ for the TYPE 219-K Decade Condensers. Their respective DC products are $2.05 \mu\text{mf}$ and $2.30 \mu\text{mf}$. These values are sufficiently large so that they must be considered in calculating the dissipation factors of all settings for both of the two lower decades.

Values of the residuals indicated in Figure 9 are given in Table III. It is also most convenient here to add together all of the residuals associated with each unit. These totals are given in the last two columns. The increases in capacitance and dissipation factor caused by these larger residuals are shown in Figure 10. These curves differ from those of Figure 6 mainly by having larger increases at the higher frequencies.

When more than one decade unit is used it is generally sufficient to assume that all of the capacitance is associated with the highest decade. This assumption will be safe except when the capacitances in the two higher decades are nearly equal, 18 or 19, or in the TYPE 219-K Decade Condenser where the TYPE 380-F Unit is so much better than

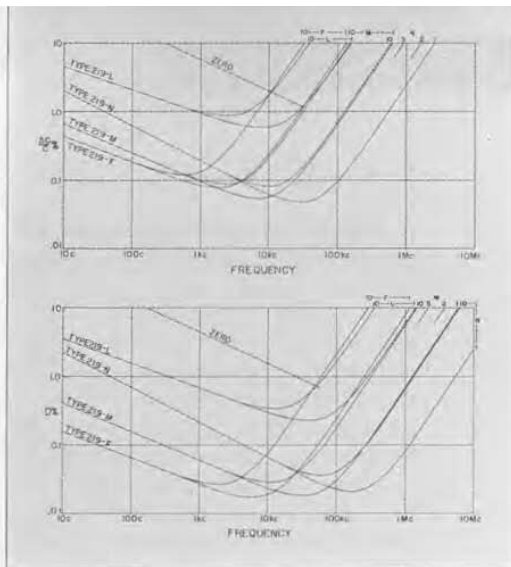

FIGURE 10. Frequency characteristics of TYPE 380 Decade Condenser Units when mounted to form TYPE 219-M and -K Decade Condensers. As compared to Figure 6, the high-frequency parts of the curves are shifted to lower frequencies.

the TYPE 380-M Unit. In any case, however, it must be recognized that the data and curves given in this article are average values, considerably smaller than the catalog limits, which may at times be approached. Divergencies from the given average values will be least for residual inductances, and most for the dissipation factors from dielectric polarization. High relative humidity can greatly increase the dissipation factor of the zero capacitances and to a lesser extent the capacitances and dissipation factors of the condensers themselves. The dissipation factors of the separate condensers may vary by a factor of two or three among themselves, and their capacitances are only adjusted within $\pm 1\%$, $\pm 2\%$ for TYPE 380-L. It follows, therefore, that accurate values of any particular decade condenser can be obtained only by extensive measurements on that particular instrument.

— R. F. FIELD

PERIODIC MAINTENANCE WILL KEEP THEM IN SERVICE

● **ONE USER OF GENERAL RADIO** standard-signal generators reports that the generators are working around the clock — three eight-hour shifts a day — and have not been turned off for four months! We know, and the user knows, that these instruments are built for intermittent service, and that their ability to stand up under these unusual demands is a tribute to the excellence of their mechanical design and construction. But we both also know that a definite schedule of periodic inspection and maintenance is what makes this performance possible.

If your General Radio instruments are being used in production testing, set up a maintenance schedule and see that it is rigidly followed. The small cost and bother will be saved many times over in eliminating the hours that are lost when instruments must be returned to us for repair.

Get a set of Service and Maintenance Notes for your General Radio instruments from our Service Department. These will help you to locate trouble and

to identify defective components. Inspect, lubricate, and clean moving parts regularly, and if gears, slide wires, or other parts show serious wear, get a replacement from our Service Department and have it ready to install before actual failure. If major failures occur, write to our Service Department, which is equipped to give prompt service to war plants.

Our Service and Maintenance Notes are compiled from Service Department records (we keep a complete case history file for all major instruments), from our standards laboratory test specifications, and from engineering department suggestions. They have already helped hundreds of General Radio customers to get better service from their equipment, and to save valuable production time.

If you do not already have our Service and Maintenance Notes, write to our Service Department. You will receive in return a form on which to list the type number, serial number, and approximate date of purchase of your General Radio instruments. When the form is returned, the notes will be mailed to you promptly.

***T**HE General Radio EXPERIMENTER is mailed without charge each month to engineers, scientists, technicians, and others interested in communication-frequency measurement and control problems. When sending requests for subscriptions and address-change notices, please supply the following information: name, company name, company address, type of business company is engaged in, and title or position of individual.*

GENERAL RADIO COMPANY

30 STATE STREET - CAMBRIDGE A, MASSACHUSETTS

BRANCH ENGINEERING OFFICES

90 WEST STREET, NEW YORK CITY

1000 NORTH SEWARD STREET, LOS ANGELES, CALIFORNIA



IET LABS, INC in the GenRad tradition

534 Main Street, Westbury, NY 11590

TEL: (516) 334-5959 • (800) 899-8438 • FAX: (516) 334-5988

www.ietlabs.com