



# BROADCAST EQUIPMENT



# **RCA**

# **BROADCAST STATION**

# **EQUIPMENT**

\*

**1941**

**Price . . . Fifty Cents**

---

*Transmitter Section*

**RCA MANUFACTURING COMPANY, INC.**

*A Service of Radio Corporation of America*

**Camden, N. J.**

---

**With Branches, Factories or Subsidiaries Located in:**

Harrison, N. J.	Montreal, Canada	Rio de Janeiro, Brazil
Indianapolis, Ind.	Mexico City, Mexico	London, England
Hollywood, Calif.	Buenos Aires, Arg.	Santiago, Chile
Bloomington, Ill.	Caracas, Ven.	

---

**Transmitter Sales Offices at:**

1270 Sixth Avenue New York City	589 E. Illinois Street Chicago, Ill.	530 Citizens' and Southern Bank Bldg. Atlanta, Ga.
Santa Fe Bldg. Dallas, Texas	1016 N. Sycamore St. Hollywood, Calif.	170 Ninth Street San Francisco, Calif.

---

Copyright 1940 RCA Manufacturing Company, Inc.

# INTRODUCTION

•

**T**HE information presented in this third edition of the RCA Broadcast Equipment Catalog is intended to be sufficiently comprehensive to give a clear picture of each piece of apparatus. However, individual bulletins are available for each major unit and may be obtained upon request. Attention is also directed to the comparative tables at the end of each section where differences and similarities of apparatus are clearly set forth and the conditions of use outlined. If there is any doubt as to the type of equipment required, it is recommended that the reader first consult the proper table and then the individual unit, rather than vice versa.

We would also like to call your attention to several new sections dealing with Frequency Modulated Transmitters and Antenna Phasing Equipment. In addition, many of the units shown previously, have been restyled or redesigned so that they are now essentially new items.

Due to the fact that this catalog is primarily intended for the use of broadcast stations, we have avoided detailed descriptions of the many other lines of equipment built by RCA. For those, however, who may be interested in Commercial Sound, Police, Aviation, Photophone, Radio Receivers or Records, we have available, separate catalogs or descriptive bulletins issued by the divisions handling these special products.

# EVERYTHING IN RADIO—

from the microphone in the studio to the receiver in the home—is produced in these strategically located plants of the RCA Manufacturing Co., Inc.

◀ *Camden, N. J., the largest unit of the RCA Manufacturing Co., Inc., produces Broadcast Transmitters, Speech Input Equipment, RCA Radio Receivers and Victrolas, Victor Records, Television and Facsimile Equipment, Electron Microscopes, Electronic Equipment for industrial applications, Police and Aviation units.*

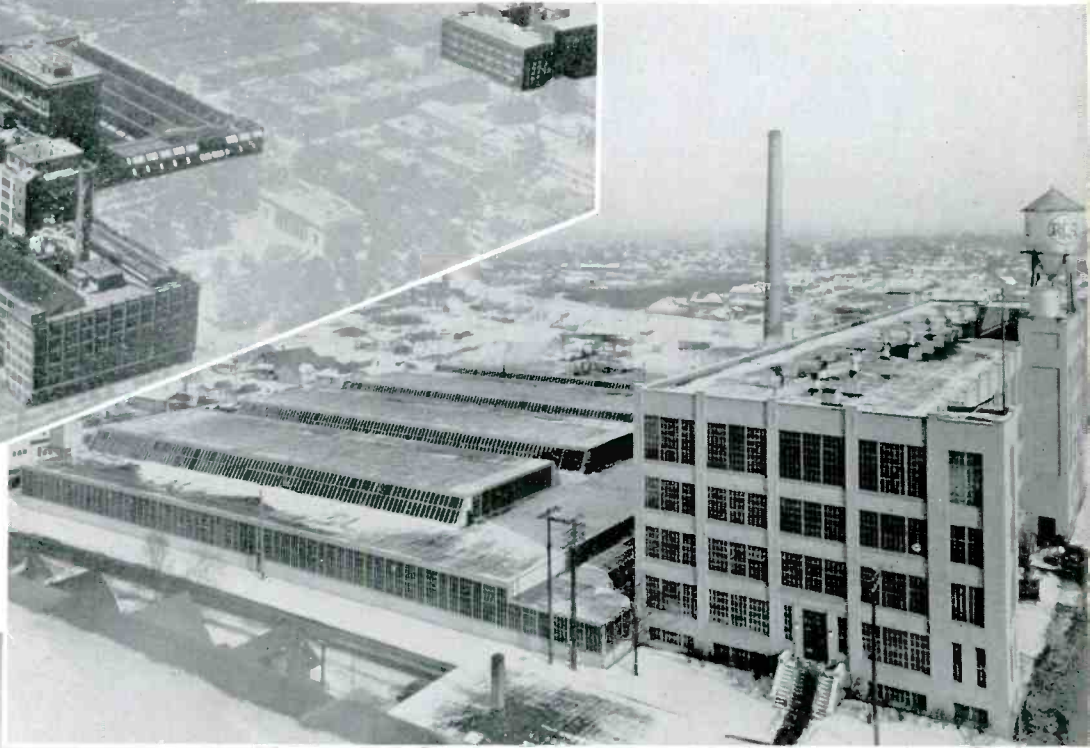
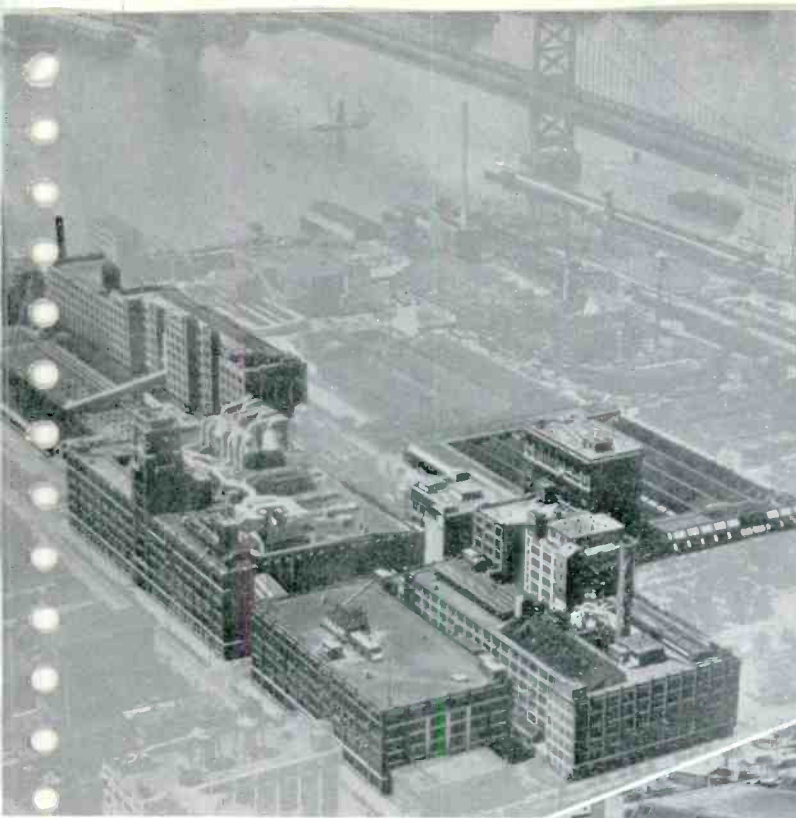

○ Indianapolis, Ind., manufactures Speech Input, Photophone, Commercial Sound and Records. ▶

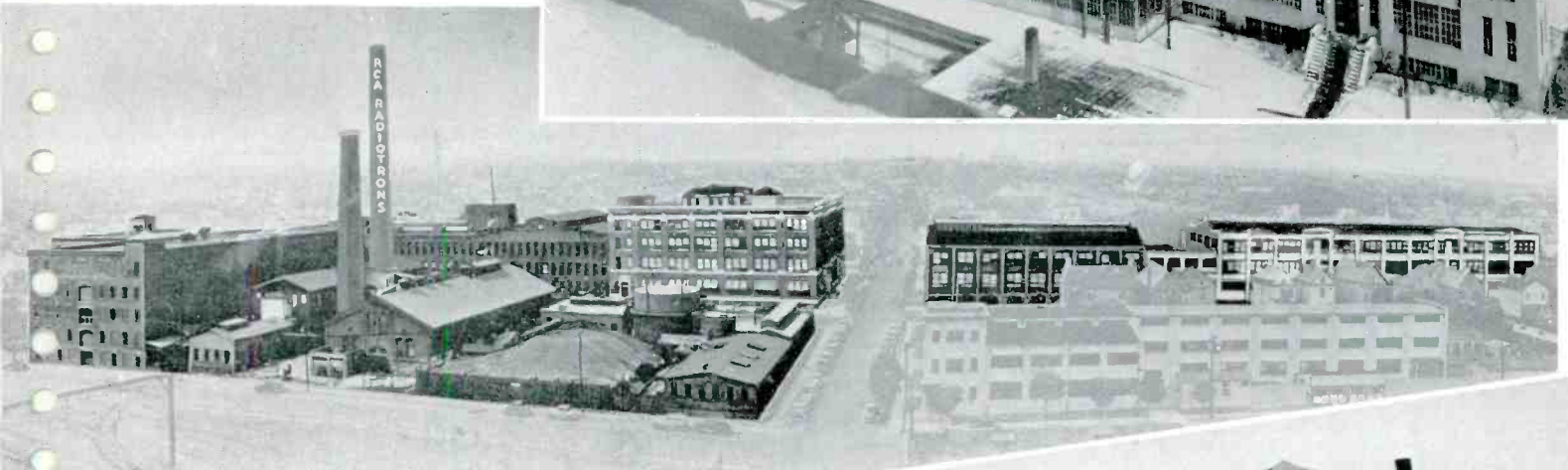

▲ Harrison, N. J., makes Transmitting, Television, Receiving, Cathode-Ray and Special Purpose Tubes.



▲ Bloomington, Ind., is the home of Little Nippers and Personal Radios.

◀ *Hollywood, Cal., produces Recording Equipment, Photophone units and Records.*

# INDEX

	PAGE		PAGE
Microphones .....	2-10	10,000 watt Unit .....	69
Microphone Accessories .....	9	50,000 watt Unit .....	70-71
Microphone Tabulation .....	10	Antenna Tuning Units .....	72-73
Speech Input Equipment .....	12-56	Antenna Phasing Equipment .....	74-76
Custom Built Installations .....	12-13	Frequency Modulated Units .....	77-79
Factory Assembled Units .....	14-18	Television Equipment .....	81-84
De Luxe Line Units .....	19-23	Measuring Equipment .....	86-105
Standard Line Units .....	23-25	Electron Microscope .....	106
Economy Line Units .....	26-35	Crystal Units .....	108-122
Amplifier Tabulation .....	36	Tabulation of Crystals .....	122
Speech Input Accessories .....	37-43	Faradon Condensers .....	123-130
Transcription Turntables and Accessories .....	44-47	Transmitting and Special Purpose Tubes .....	132-134
Recording Equipment .....	48-51	Other RCA Products .....	135-142
Loudspeakers .....	52-53	Aviation Radio Equipment .....	136
Field Amplifier Equipment .....	54-56	Police Radio Systems .....	137
Transmitters .....	60-80	Commercial Sound Equipment .....	138
100-250 watt Units .....	61-63	Photophone Equipment .....	139
1000 watt Unit .....	64-65	Communications Equipment .....	140-141
5000 watt Unit .....	66-67	RCA Receivers .....	142
Control Desk .....	68	Data Section .....	143-154

## INDEX BY TYPE NUMBERS

TYPE	EQUIPMENT	PAGE	TYPE	EQUIPMENT	PAGE	TYPE	EQUIPMENT	PAGE
1-K	Transmitter .....	64	83-C	Amplifier .....	32	351-A	Video-Sweep Oscillator..	101
5-DX	Transmitter .....	66	84-B	Amplifier .....	31	352-A	R-F and I-F Sweep Os-	
9-AJX	Cabinet Rack .....	37	85-B1	Amplifier .....	27		cillator .....	102
9-AX	Cabinet Rack .....	37	85-X	Amplifier .....	28	353-A	Sweep Rectifier .....	102
9-AJZ	Cabinet Rack .....	37	86-A	Amplifier .....	34	560-A	Synchronizing Generator	102
9-AUX	Cabinet Rack .....	37	87-A	Amplifier .....	30	580-A	Power Unit .....	90
9-AUZ	Cabinet Rack .....	37	88-A	Microphone .....	6	9641	Oscillograph .....	88
10-DX	Transmitter .....	69	89-B	Attenuator .....	93	9765	Vibration Pickup .....	105
13-D	Volume Indicator .....	93	90-A	Stand .....	9	9787	Vibration Pickup Cali-	
15-B	Meter Panel .....	24	90-C	Stand .....	9		brator .....	105
15-D	Meter Panel .....	29	91-A	Pedestal .....	9	9819	D-C Meter .....	89
30-A	Microphone .....	8	91-B	Stand .....	9	AC-95	Crystal .....	117
33-A & B	Jack Panels .....	39	92-A	Choke Coil .....	79	ACT-20	Transmitter .....	140
36-A	Panel and Shelf .....	35	93-A	Power Unit .....	90	AR-67	Receiver .....	141
36-B	Panel and Shelf .....	35	94-D	Amplifier .....	23	AR-77	Communication Receiver	140
40-C	Amplifier .....	25	105	Antenna Tuning Unit.....	73	AR-4291	Transceiver .....	141
40-D	Amplifier .....	21	160	Oscillograph .....	87	AVA-10	Crystal .....	113
41-B	Pre-amplifier .....	24	250-D	Transmitter .....	61	AVA-11	Crystal .....	114
41-C	Pre-amplifier .....	20	250-FM	Transmitter .....	77	AVA-37	Crystal .....	115
44-BX	Microphone .....	2	250-K	Transmitter .....	62	AVA-53	Crystal .....	116
50-E	Transmitter .....	70	300-A	Phase Meter .....	94	AZ-4293	Antenna Tuning Unit ...	79
55-B	Amplifier .....	22	300-B	Antenna Indicator Kit....	95	ET-4331	Transmitter .....	140
56-B, C, D, E	Line Equalizers .....	42	301-A	Field Intensity Meter.....	99	ET-4332-A	Transmitter .....	141
57-C	Switch and Fuse Panel ..	39	302-A	Audio Meter .....	89	FM-1-A	Transmitter .....	77
59-B	Stand .....	9	303-A	Frequency Limit Monitor	96	FM-1-B	Transmitter .....	78
64-B	Cabinet Speaker .....	52	304-A	Oscillograph .....	87	FM-10-A	Transmitter .....	78
66-A	Monitor .....	94	305-A	Oscillograph .....	86	FM-50-A	Transmitter .....	79
68-B	Oscillator .....	91	306-A	Audio Frequency Meter	96	OP-5	Field Amplifier .....	56
69-B	Distortion Meter .....	92	307-A	Pressure Conversion Unit	103	OP-6	Remote Amplifier .....	54
70-C	Transcription Turntable	44	308-A	Field Intensity Meter ...	98	OP-7	Portable Mixer Ampli-	
71-C	Pickup Attachment .....	45	310-A	Power Unit .....	90		fer .....	55
72-C	Recording Attachment ..	46	311-A	Frequency Monitor .....	97	OR-1	Portable Recording	
73-A	Recording Equipment ....	48	312-A	Noise Meter .....	100		Equipment .....	50
74-B	Microphone .....	3	314	Engine Pressure Meas-		RB-2	Pack Transmitter .....	79
76-B2	Consolette .....	16		uring equipment .....	103	T-1	Television Transmitter..	83
77-B1	Microphone .....	4	315-A	Electronic Switch .....	88	TMV-129-B,C	Crystal Holders .....	118
77-C1	Microphone .....	5	317-A, B, C	Accessories for 312-A ...	100	TMV-135	Crystal .....	119
78-B1	Speech Input .....	14	318-B	Direction Finder Attach-		TMV-135-R	Crystal .....	120
78-C1	Speech Input .....	15		ment .....	100	UZ-4209	Unmounted Speaker .....	53
80-B	Control Desk .....	18	319-A	Pre-Amplifier .....	104	UZ-4309	Unmounted Sneaker .....	53
82-B	Amplifier .....	33	350-A	Square-Wave Generator..	101			

# INDEX BY MASTER ITEM NUMBERS

MI	DESCRIPTION	PAGE	MI	DESCRIPTION	PAGE	MI	DESCRIPTION	PAGE
MI-63 A, 64, 65	Interconnecting Cable	40	MI-4309A	Meter Panel .....	24	MI-4916	Recording Filter .....	47
MI-501			MI-4388	Meter Panel .....	29	MI-4917	Sound Effects Filter..	43
MI-502A } MI-503A }	Jack Mats .....	39	MI-4395A	Switch and Fuse Panel	39	MI-6222/6224/4-6234	Console Speaker .....	53
MI-4001B	Microphone .....	8	MI-4400A, B, C	Cabinet Type Speaker	52	MI-6223/6237	Wall Speaker .....	53
MI-4016	Stand .....	7	MI-4405, A, B, C	Speaker Base .....	52	MI-6226-D	Microphone .....	7
MI-4017	Microphone .....	7	MI-4460 }	Unmounted Speakers	53	MI-6227	Stand .....	7
MI-4027B	Microphone .....	2	MI-4461A }			MI-6233	Cone Speaker .....	53
MI-4036K	Microphone .....	3	MI-4519/4524	Cabinet Rack .....	37	MI-6261/6294	Talkback Speaker ....	53
MI-4043	Microphone .....	4	MI-4519/4537	Cabinet Rack .....	37	MI-7112	Lighting Choke Coil	72
MI-4011A, B	Microphone .....	5	MI-4519/4656	Cabinet Rack .....	37	MI-7423	Antenna Tuning Unit	72
MI-4048A	Microphone .....	6	MI-4519/4658	Cabinet Rack .....	37	MI-7444	Antenna Tuning Unit	73
MI-4058A	Stand .....	9	MI-4589/4599	Blank Panels .....	37	MI-7485, A, B	Phasing Equipment ..	74
MI-4065B	Stand .....	9	MI-4620B	Connector .....	8	MI-7487	Inductor .....	75
MI-4068A	Stand .....	9	MI-4624A	Receptacle .....	8	MI-7493A	Inductor .....	75
MI-4089	Cable Hook .....	8	MI-4630B	Plug .....	8	MI-8400	Pack Transmitter .....	79
MI-4090	Stand .....	9	MI-4645/4646	Jack Panels .....	39	MI-11202	Remote Amplifier ....	54
MI-4092	Stand .....	9	MI-4647C, D	Console .....	14	MI-11204	Program and Line Amplifier .....	31
MI-4093	Stand .....	9	MI-4647E, G	Console .....	15	MI-11205	Monitoring Amplifier	33
MI-4094	Stand .....	9	MI-4652-2A, 4A, 6	Patch Cords .....	39	MI-11206B	Isolation and Line Amplifier .....	32
MI-4162	Line Equalizer .....	42	MI-4681C, E, G	Panel and Shelf .....	35	MI-11207A	Microphone Pre- amplifier .....	27
MI-4167A	Line Equalizer .....	42	MI-4682, A, B	Panel and Shelf .....	35	MI-11208	Isolation Amplifier ..	28
MI-4168	Line Equalizer .....	42	MI-4867	Vertical Pickup At- tachment .....	45	MI-11210	Portable Recording Equipment .....	50
MI-4169	Line Equalizer .....	42	MI-4871, A	Transcription Turn- table .....	41	MI-11213	Portable Amplifier ..	55
MI-4205E	Pre-amplifier .....	24	MI-4877	Recording Attach- ment .....	46	MI-11214	Battery Box .....	55
MI-4206	Three Channel Pre- amplifier .....	20	MI-4887	Recording Head .....	47	MI-11215/4171-25	Booster Amplifier 30,	45
MI-4215	Bridging Amplifier...	22	MI-4894	Recording Equalizer	47	MI-11216	Limiting Amplifier ..	34
MI-4223C, G, E	Field Amplifier Equipment .....	56	MI-4898	Frequency Compen- sator .....	45	MI-11302	Pre-amplifier Power Supply .....	29
MI-4270	Monitoring Amplifier	23	MI-4900A }			MI-11500	Wall Mounting Cab- inet .....	38
MI-4292C	Program Amplifier ....	25	4901	Terminal Transform- ers .....	41	MI-11604B, G	Control Desk .....	18
MI-4295A	Program Amplifier ....	21	4902			MI-11606	Filament Transformer	29
MI-4296C, D	Rack .....	14	4903			MI-11613A/11301A	Consolelette .....	16
MI-4296E, G	Rack .....	15	4904			MI-19407	FM Exciter .....	77
MI-4308A, C	Relay and Signal Lamp Power Supply .....	40	MI-4914	Reproducing Filter ..	45			
MI-4308C, D	Relay P. S. ....	14	MI-4915	Recording Equipment	49			



# FOREWORD

The activities of RCA embrace every field of the radio art and its services reach almost every country of the globe. Its operations in these many fields are carried on by its five subsidiary companies, each of which confines its activities to one of the well defined major divisions of the radio industry. Thus, RCA Communications, Inc., which is strictly an operating company, maintains and operates a world-wide system of international communications, as well as domestic radio circuits between the large centers of population. In addition, it provides the international program service which has made possible the successful rebroadcasting in this country of foreign programs and vice versa. In this field its direct communication circuits and its extensive diversity-type receiver installations have made it indispensable.

The Radiomarine Corporation of America, as its name implies, carries on RCA activities in the field of marine radio. In this field of radio communication, particularly important because radio is the only possible means of communication with ships at sea, the Radiomarine Corporation is one of the world's leading companies.

The National Broadcasting Company is the RCA operating company in the entertainment field. It operates two nationwide station networks and furnishes programs to a large number of stations linked together by specially engineered telephone lines and radio circuits. Of these stations NBC itself owns and operates some of the largest, while the remainder are furnished programs on a contract basis. In addition to its Radio City studios, the world's largest broadcasting plant, NBC maintains and operates extensive layouts in Chicago and Hollywood, and smaller studio installations in other station cities. It offers a complete broadcast advertising and program building service and provides radio talent of all kinds including the NBC Thesaurus transcription service.

The RCA Institutes, Inc., is a company devoted to the teaching and training of radio engineers and operators. It offers practical instruction in radio and its associated electronic arts. At its two residence

schools in New York and Chicago, it offers an extensive list of courses in every field of radio engineering and operating. In addition, it offers correspondence courses in servicing and operating radio and sound systems.

The four previously mentioned companies are all more or less operating companies. The fifth company of the RCA family—the RCA Manufacturing Company—differs in that it is devoted entirely to the development and production of radio equipment. While it furnishes the equipment used by the four RCA operating companies, this constitutes only a very small percentage of its total business. By far the greater part of its facilities are devoted to the production of equipment for sale to other users. This includes not only receivers, phonograph combinations and the like for home use, but also many types of specialized equipment for other radio and allied applications. In the development, design and test of such equipment the RCA Manufacturing Company has the benefit of the cooperation of the other RCA companies and its engineers are, therefore, in a position to take advantage of the latest and most advanced engineering knowledge. The broadcast transmitting and speech input equipment offered by the RCA Manufacturing Company is an outstanding example of this coordinated RCA development.

The extent of the far-flung RCA Services, the unequalled experience of RCA engineers and the manufacturing and laboratory facilities of the RCA Manufacturing Company have been described here in detail because of the part they have played in the development and production of the broadcast transmitters and speech input equipment which are described in the following pages. It is with pride and confidence that the RCA Manufacturing Company offers to broadcast stations this line of transmitting and speech input equipment—pride, that it is by far the finest equipment yet developed for the purpose—confidence, that it will insure continuance of the high regard with which broadcast engineers have come to hold RCA broadcast equipment.



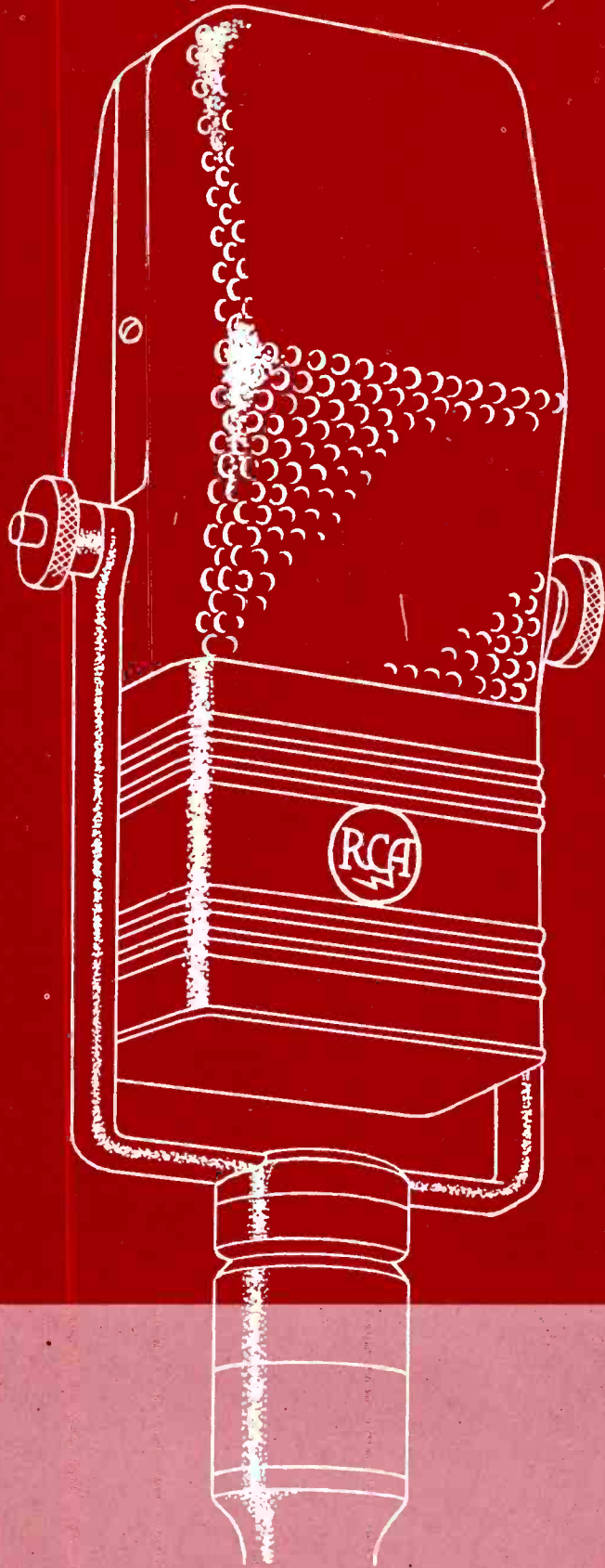

# MICROPHONES

# VELOCITY MICROPHONE

## Type 44-BX . . . The Standard Microphone of Broadcasting

MI-4027B

**T**HE TYPE 44-BX Velocity Microphone was developed by RCA engineers to meet a long standing need for a microphone capable of reproduction fidelity equal to that of the other equipment of a modern broadcast station. It is not to be compared with other types of microphones for it is totally different, both in construction and in operation; and, because of its unique features, so far excels in reproduction quality as to be properly placed in a class by itself.

The Type 44-BX Velocity Microphone, unlike other types of microphones, has no diaphragm—the moving element being, instead, a thin metallic ribbon so suspended as to be able to vibrate freely between the poles of a permanent magnet. Because of its lightness, the motion of this ribbon corresponds exactly to the velocity of the air particles and the voltage generated in it is, therefore, an exact reproduction of the sound waves which traverse it. Moreover, since it has no diaphragm and is open in construction so that air flows freely through it, the Type 44-BX Velocity Microphone is free from the effects of cavity resonance, diaphragm resonance and pressure doubling, which cause undesirable peaks in the response of all pressure type microphones. As a result it provides reproduction of unequalled uniformity and smoothness over the whole audio range.

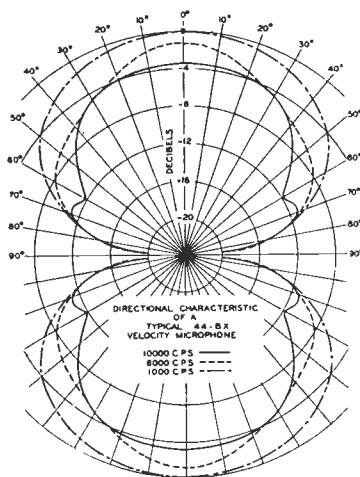
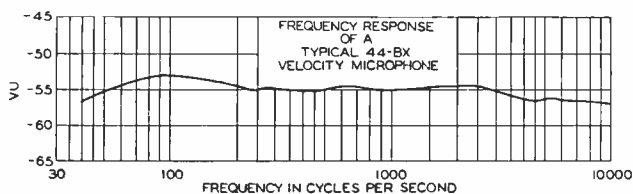

Directional Response Diagram of 44-BX



Advantages of the Type 44-BX Velocity Microphone are not limited to superb reproduction fidelity for the special characteristics represent an almost equally attractive feature. The directional pattern is of the "figure eight" type, giving the microphone a bi-directional characteristic. This is a feature of considerable convenience as it provides a pickup configuration corresponding closely to average studio dimensions. Not only does it allow placing of artists on both sides of the microphone but it also, because of the dead sides, greatly reduces reflection from side walls.

While the Type 44-BX Velocity Microphone is very sensitive, it is extremely rugged and, in general, better suited to stand hard usage than are most other microphones. Moreover, because it is constructed almost entirely of metal and because of the low impedance of the ribbon, it is unaffected by temperature, humidity or changes in air pressure. A shock-proof mounting is furnished.

### SPECIFICATIONS

- Output Impedances . . . . . 50/250 ohms
- \*Output Level . . . . . —55 VU
- Frequency Response . . . . . 30-15,000 cycles
- Finish . . . . . polished black and chromium
- Mounting . . . . . 1/2" pipe thread
- Dimensions:
- Overall length including cushion mounting . . . . . 12"
- Overall width . . . . . 4 3/4"
- Overall depth . . . . . 3 3/8"
- Weight (unpacked, including mtgs.) . . . . . 8 1/2 lbs.
- Supplied with 30' shielded cable, less plug.
- \* Sound pressure 10 dynes per cm. sq. output terminated into a matched load.

# JUNIOR VELOCITY MICROPHONE

Type 74-B . . . A Small Sized Velocity Type Microphone

MI-4036K

THE TYPE 74-B Junior Velocity Microphone is an inexpensive model which has several advantageous applications in broadcast use as well as sufficient flexibility for use in emergency under almost any conditions. It will be found particularly well suited for remote pickups at inside points. In night clubs, restaurants and the like, where lines and other limiting features make the extended response of the deluxe model unnecessary, this inexpensive unit can be used to advantage. Similarly, for banquets and speeches where the directional characteristics of the velocity type microphone are of importance, it may be found better suited than would microphones of non-directional types. It is also a useful microphone for audition studios or for small or occasionally used studios.

In design the Type 74-B Microphone is similar to its bigger brother, the 44-BX Microphone. The frequency response, while not as extended, is in general, smoother than that of other types of microphones and is free from objectionable peaks or dips throughout the range of 70 to 8,000 cycles. The built-in transformer has output connections providing impedances of 50, 250 and 15,000 ohms. The output level is approximately the same as that of the larger size RCA microphones. The 74-B Microphone is somewhat smaller than the deluxe model and is unusually light, weighing only 2½ lbs. For many pickups outside of the studios, particularly for banquets and similar occasions, microphone size is of importance not only because of portability but also because it is undesirable to obstruct the speaker's view with an unnecessarily large microphone. Obviously the Type 74-B Microphone is of advantage in this respect. The appearance also is such as to lend itself to such use. The die-punched, perforated shield is finished in chromium, while the transformer case is black. Attached to the base is a ball and socket joint which makes it possible to rotate the microphone in any direction and to tilt it as desired.

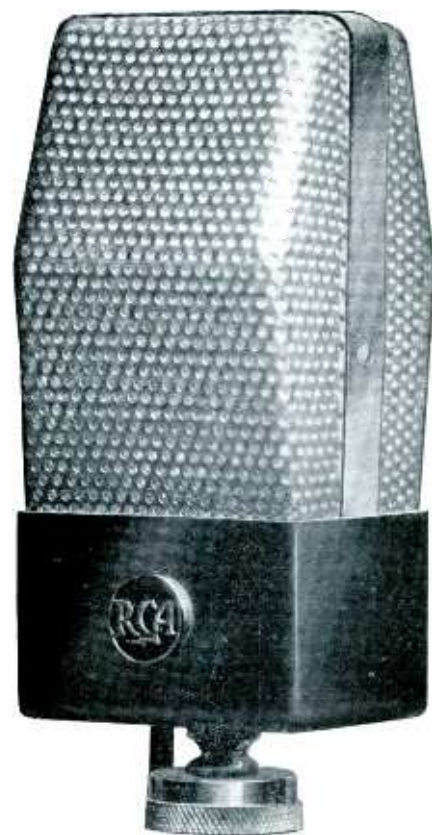

## SPECIFICATIONS

- Output Impedance . . . . . 50/250/15,000 ohms
- \*Output Level . . . . . —56 VU
- Frequency Response . . . . . (See curve)
- Finish . . . . . Polished Black and Chromium
- Dimensions (overall) . . . . . 7¾" high, 4" wide and 2½" deep.
- Weight . . . . . 2½ lbs.

A ball and socket mounting (½" pipe thread) and a 30' shielded rubber covered cable less plug are furnished.

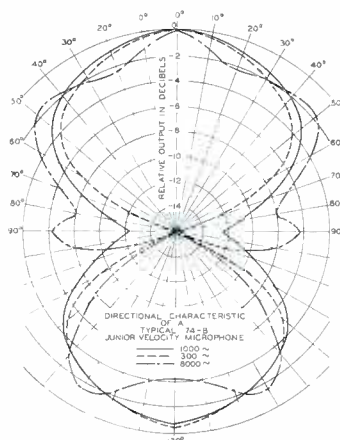

\* Sound pressure 10 dynes per cm. sq. output terminated into a matched load.

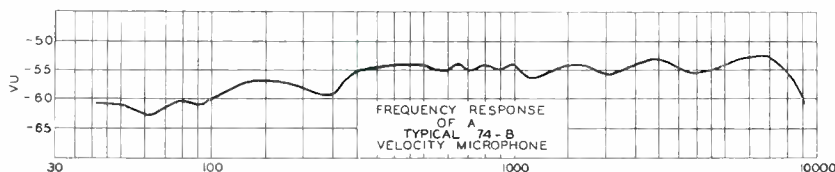

# UNI-DIRECTIONAL MICROPHONE

## Type 77-B1 . . . A Special Microphone for Critical Pickups

MI-4043

THE TYPE 77-B1 Uni-directional microphone can be used to excellent advantage in practically any type of studio installation. For example, in an auditorium studio or in one which provides space for an audience, this Uni-directional microphone can be used to pickup the entire action on the stage because of its cardioid pattern and will suppress, approximately 20 to 1, any undesirable noises originating in the audience. It can also be used to advantage in small studios where the reverberation time tends to be objectionable, precluding the use of a non-directional microphone. In a given studio, the type 77-B1 microphone can be used with approximately 1.73 times less reverberation pickup than a non-directional microphone. It is ideal for applications where it is necessary to place a microphone close to a wall or a window, since the pickup of reflected sound from the wall or glass is materially reduced.

Its operation is similar to that of the type 77-A Uni-directional microphone which it supersedes, namely; a single ribbon fixed at the center, one-half operating as a velocity microphone and the other half operating as a pressure type. The two outputs of the ribbon are connected in series and the resultant vector addition of the generated voltages produces a directional characteristic as shown below. This curve also shows the uniformity of the directional response with respect to frequency. The microphone's small size, light weight, rugged construction and good sensitivity recommend it as one which no station can afford to lack.

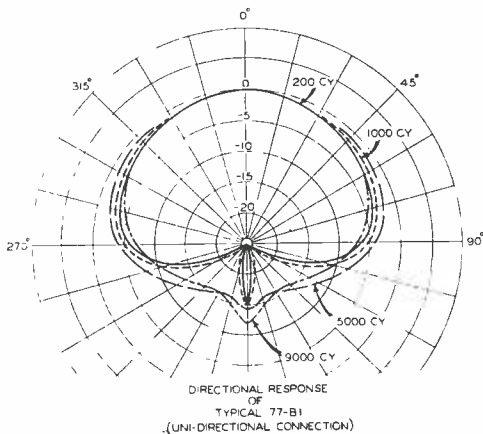

### SPECIFICATIONS

Output Impedances . . . . .	50/250/500 Ohms
*Output Level . . . . .	—66 VU
Frequency Response . . . . .	See curve
Directional Ratio . . . . .	10 to 1 —20 db.
Finish . . . . .	Polished Black and Chromium
Mounting . . . . .	1/2" pipe thread
Dimensions overall length (including mounting) 10"; width 3 3/4"; depth 2 1/2"	
Weight . . . . .	Unpacked including mounting 2 lbs.

Supplied with 30' three conductor shielded cable, less plug.

\* Sound pressure 10 dynes per cm. sq. output terminated into a matched load.

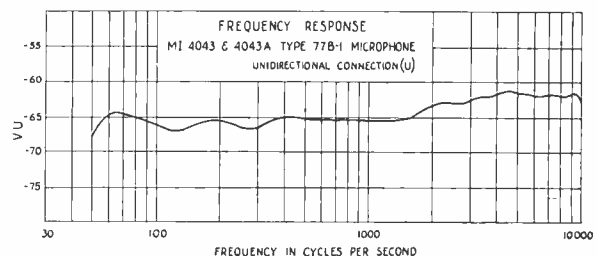

# COMBINATION MICROPHONE

Type 77-C1

*Non-Directional, Bi-Directional or Uni-Directional Response at the Turn of a Switch*

MI-4044B (250/500 ohms)

MI-4044A (30/60 ohms)

THE TYPE 77-C1 microphone which is slightly more expensive than the type 77-B1 provides the station owner with the equivalent of three microphones in a single unit. The general construction is similar to that of the 77-B1. It can be used in all applications where a uni-directional microphone is desirable and in addition can be operated at the turn of a switch located in the base of unit as a bi-directional velocity microphone or as a pressure operated non-directional microphone. Its exceptionally fine frequency characteristics are shown below, together with the directional patterns when used as any one of these three types.



## SPECIFICATIONS

Output Impedance (MI-4044B) .....250/500 ohms  
(MI-4044A) ..... 30/60 ohms

\*Output Level Uni-directional .....-66 VU  
Bi-directional .....-67 VU  
Non-directional .....-66 VU

Frequency Response.....See Curves

Directional Ratio .... (Uni-directional) 10 to 1—20 db

Finish.....Polished black and chromium

Mounting..... $\frac{1}{2}$ " pipe thread

Dimensions Overall length—inc. mounting ..... $8\frac{1}{2}$ "

Overall width—inc. mounting ..... $3\frac{3}{8}$ "

Overall depth—inc. mounting..... $2\frac{1}{4}$ "

Weight ..... 3 lbs.  
Supplied with 30' 3 conductor shielded cable, less plug.

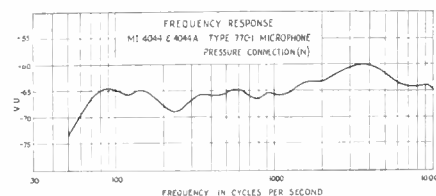
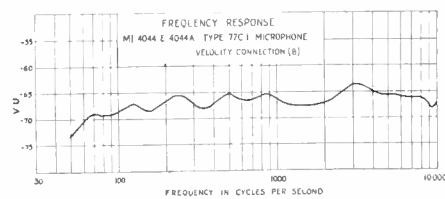
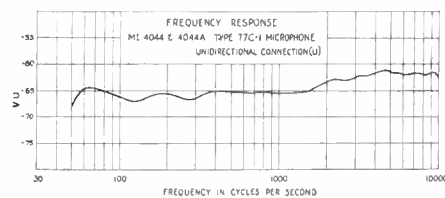
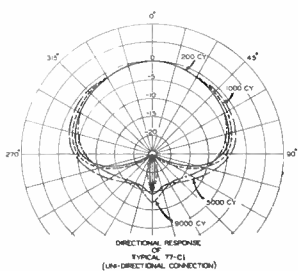
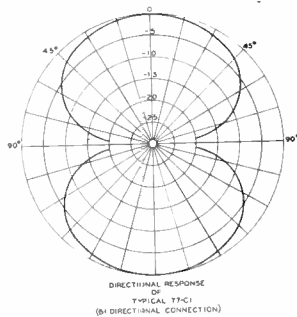
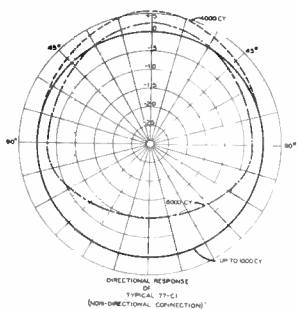

\* Sound pressure 10 dynes cm. sq. output terminated into a matched load.

# PRESSURE MICROPHONE

## Type 88-A

*A Rugged Non-Critical Unit Especially Suited for Remote Pickups*

MI-4048A



*The 88-A Microphone (MI-4048A) is shown mounted on the 91-B Desk Stand (MI-4092)*

**T**HE TYPE 88-A Pressure microphone excels in the four requisites of an ideal remote pickup microphone, namely; light weight, high output, good frequency response and freedom from the effects of wind and moisture.

Tipping the scales at but one pound it is truly the remote pickup man's ideal microphone. In spite of its light weight and small size, it is extremely rugged and well-suited to stand the hard usage to which a remote microphone is put. The high output, —56 VU, keeps the signal-to-noise ratio in any remote pickup at least 6 db. better than ever available in a microphone of this quality. The frequency response as shown below extends from 60 to 10,000 cycles with remarkably few peaks usually found in a pressure or inductor type microphone. Its diaphragm

of molded styrol is practically impervious to moisture and together with the wind screen supplied with this microphone makes the effects of objectionable currents of air practically unnoticeable. Like all RCA microphones it is styled and finished in a manner which will make you proud to use it under any circumstances.

Not only is the type 88-A pressure microphone ideal for remote pickups, but also because of these very qualities it is excellent for many types of studio use where a non-directional microphone is desirable. Not content with making a microphone of this quality, RCA engineers have designed it to sell at a surprisingly low cost in comparison with any type microphone.

### SPECIFICATIONS

- Output Impedances.....50/250 ohms
  - \*Output Level.....—56 VU
  - Frequency Response.....See curves
  - Finish.....Polished black and chromium
  - Mounting..... $\frac{1}{2}$ " pipe thread
  - Dimensions.....Overall length 4 $\frac{1}{2}$ "; width 2 $\frac{1}{8}$ "; depth 4"
  - Weight.....1 lb.
- MI-4048-A supplied with 30' shielded cable, less plug.

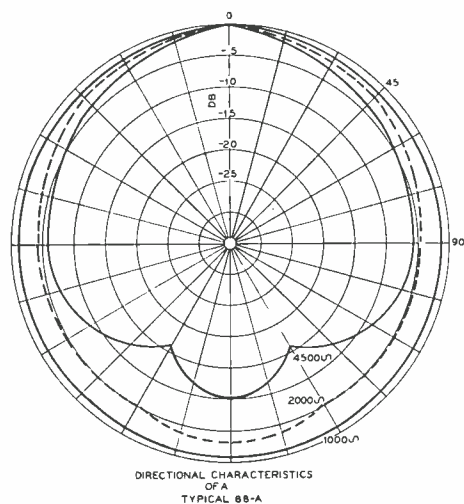

DIRECTIONAL CHARACTERISTICS OF A TYPICAL 88-A

*Directional Characteristics When Mounted Horizontal*

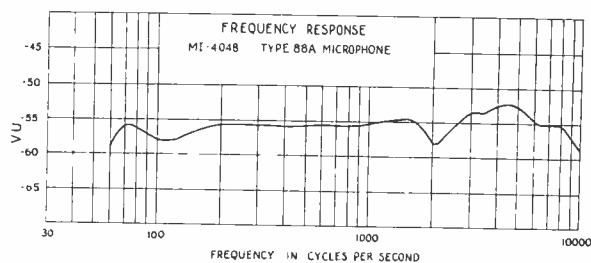

\* Sound pressure 10 dynes per cm. sq. output terminated into a matched load.

# SPECIAL TALKBACK MICROPHONE

## *Featuring Unusually High Output Level*

### Press-to-Talk Microphone

Microphone MI-4017

Stand MI-4016

A NEED has long been felt in the broadcast industry for a talk-back microphone with good, intelligible, quality, modern appearance and an output level sufficiently high for it to be fed directly into the monitor amplifier. The MI-4016/4017 press-to-talk microphone incorporates all of these features and several others extremely desirable in this type of equipment, including a press-to-talk switch assembled in the stand. When fed into a 250 ohm load the frequency response of this microphone extends from 200 to 2500 cycles. It is mounted in a case almost identical with that of the aero-dynamic microphone, presenting a fine streamlined appearance. The stand, which is approximately 12" high, is likewise modern in appearance and contains a short black bar, which, when pressed, closes a single pole switch. The four-conductor cable normally supplied contains a pair of leads from the output of the microphone and another pair which is the d. c. circuit to the switch.

Its obvious application is to enable the operator to talk back from the control room to the studio. However, another of its many applications is for a program director's microphone. It may be connected across the terminals of the present talk-back key enabling the program director to walk around the control room with this microphone in his hand. This system permits both the operator and the director to talk back into the studio simultaneously or one at a time, each using his own microphone.

The stand is provided with an adapter which permits the use of an 88-A Microphone.



*The MI-4016/MI-4017 Microphone and Stand*

### SPECIFICATIONS

Output Impedance.....	250 ohms
*Output Level.....	—39 VU
Frequency Response.....	200-2500 cycles
Finish.....	Polished back and chromium
Mounting.....	Complete with stand
Dimensions.....	Overall height, 12"; Base diameter, 5"
Weight.....	1½ lbs.

Supplied with 6' of 4 conductor cable, less plug

\* Sound pressure 10 dynes per cm. sq. output terminated into a matched load.

# AERODYNAMIC MICROPHONE Type MI-6226-D

## *An Inexpensive Pressure Type Microphone for Talkback Use*



*The Aerodynamic Microphone with the MI-6227 Stand (special for this microphone).*

THE TYPE MI-6226-D Aerodynamic Microphone is an inexpensive unit which, while not designed specifically for broadcast use (as are all of the preceding models), nevertheless, has one particular application for broadcast purposes: viz, where a microphone is needed for communication ("talkback") from the booth to the studios.

The Type MI-6226-D Microphone neatly meets the ordinary requirements for talkback purposes. While the frequency response is limited, it is sufficient for pleasing voice transmission—all that is required. In emergency it is good enough for announce use. The output level is comparable to that of broadcast type microphones, facilitating switching. The unit is of convenient dimensions, is housed in a chromium plated, streamlined (tear-drop) case of attractive design and can be furnished with a convenient matching stand. Finally, because of quantity production, it offers the advantages of reliability and comparatively good quality at an unusually low price. Use MI-6227 Stand.

### SPECIFICATIONS

Output: 250, 40,000 ohms. Output Level: for a 10-bar input, (250 ohm load) —63VU. Frequency Response: 100 to 6000 cycles, rising. Finish: chromium. Dimensions: 2 5/8" diameter, 3 3/8" deep. Weight: 1 1/4 lb. (net). Accessories: 30 ft. cable furnished—stands available. (Type MI-6227 illustrated.)

# LAPEL MICROPHONE

Type 30-A . . . A Velocity Type Unit for Especially Difficult Pickup Conditions

MI-4001B

**T**HE TYPE 30-A Lapel Microphone has been developed to meet a very particular situation: viz, that where the speaker or artist requires a wider latitude of movement than can be tolerated when the pickup is made with a fixed microphone. This may occur at banquets and similar events, particularly when the speaker is unaccustomed to addressing a fixed microphone, and even in the studio as, for instance, in demonstrations of cooking and the like.

Essentially the Type 30-A Lapel Microphone is a miniature velocity microphone similar in principle of operation to the deluxe Type 44-BX microphone. The pickup pattern is such that when it is placed in correct position on the coat lapel the movements of the speaker's head are normally such that his mouth traces a path on a sphere of equal sensitivity and the pickup, therefore, remains at an equal volume regardless of head movement.

## SPECIFICATIONS

Output Impedance: 250 ohms. Output Level: for a 10-bar input, (250 ohm load)—75 VU.\* Frequency Response: fair uniformity from 80 to 7000 cycles. Finish: plain black. Dimensions:  $1\frac{3}{8}$ " x  $1\frac{5}{16}$ " x  $1\frac{5}{16}$ ". Weight:  $3\frac{1}{4}$  oz. Accessories: a microphone-to-line transformer which is a separate unit is furnished, also the connecting cable and 25' of special flexible cord with plug.

(NOTE: The separate transformer is approximately the same size.)

\* Sound pressure 10 dynes per cm. sq. output terminated into a matched load.

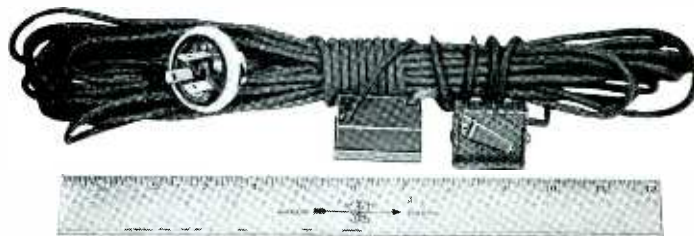

30-A Lapel Microphone

## MI-4089 CABLE HOOK

MI-4089



THE MI-4089 Cable Hook is an accessory to be used with the 90-A Program Stand. One of these hooks mounted on a 90-A Stand provides a convenient place for holding the microphone cable when it is not in use. The MI-4089 Hook is easy to install and is finished in scratch brush chromium to match the finish of the 90-A Stand. It weighs 17 ounces.

## MICROPHONE CABLES

**M**ANY stations have requested microphone cable to be used as extension cords or for replacing old microphone cables and it has been decided to place on sale the special RCA microphone cable now used on almost all standard RCA microphones. This cable consists of two conductors, each 41 strands of .0063, rubber covered, with copper braid as a shield. Over the top of this shield is wound a cotton braid and this is completely covered with a special rubber composition making a very flexible cable entirely waterproof. This cable is .285" O.D. and is supplied in any length.

## MICROPHONE PLUGS AND RECEPTACLES

MOST RCA microphones are sold without plugs in order that the purchaser may use any type desired. However, Cannon fittings are recommended for their reliability and freedom from noise. For convenience to broadcasting stations, a number of these fittings are stocked by RCA.

MI-4630B P3-CG-12S Male Plug for microphones (locking) (Satin Chrome).

MI-4624-A P3-35 Wall Receptacle for plug (no cover) (Satin Chrome).

MI-4620B P3-CG-11S Female Connector for plug (extensions) (Satin Chrome).

The P3-35 receptacle will fit in a Sprague No. SP-5800 outlet box. Provision is made in plugs and receptacles for three connections.

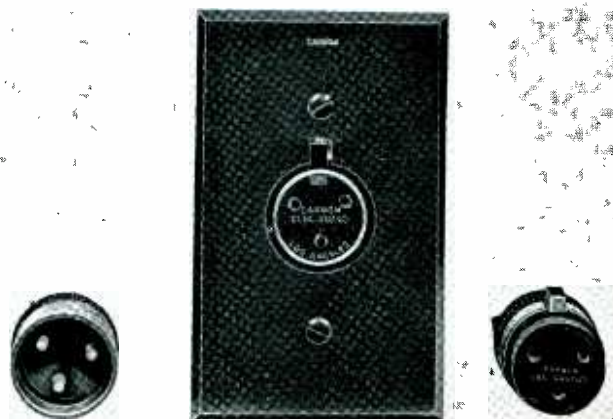



# Microphone Accessories . . . Stands

## ◀ 90-A PROGRAM STAND

MI-4090

THE 90-A Program Stand is a new handsomely finished microphone stand, adjustable in height and designed for use with the 44-BX, 77-A, 77-B, 77-C, 88-A or 74-B microphones. It is of modern appearance, designed by John Vassos and its satin chrome finish will match with practically all studio decorations. By the use of a new, patented clamping device, the height of the stand may be changed without operation of any release mechanism. It may easily be lowered or raised, as desired, and will retain its position without chance of slipping. The clamp is one which is not subject to excessive wear and is simple and free from complications. Its base is equipped with equalizing projections to assure a firm position on an uneven floor.

### SPECIFICATIONS

Adjustable in height from 44" to 73 $\frac{3}{4}$ " above the floor. Diameter of base 12 $\frac{1}{4}$ ". Finish: Satin chrome. Threaded to take microphones, standard  $\frac{1}{2}$ " pipe thread. Cable guides included. Weight 33 lbs.

## 90-C BOOM MICROPHONE STAND ▶

MI-4094

THE RCA type 90-C Boom Microphone Stand covers such magnitude of adjustments that it will find many applications around a broadcast station. It is especially suited for piano pickups and arrangements where it is desirable to locate a microphone close to the source of sound. It is also ideal for picking up large orchestra groups where it may be necessary to locate the microphone at a height greater than can be obtained with the Type 90-A stand. The base is provided with three rubber tired castors which eliminate noise and facilitate movement.

### SPECIFICATIONS

Adjustable height from 55" to 95". Adjusting of horizontal arm 59 $\frac{1}{2}$ " to 90". Horizontal arm may be swung through an angle of 150 degrees. Weight 62 lbs. Cable support provided. Threaded to take standard 44-BX, 74-B, 77-B1, 77-C or 88-A microphone. Standard  $\frac{1}{2}$ " pipe thread. Finish—Satin Aluminum and Black.



## ◀ 91-A ANNOUNCE PEDESTAL

MI-4058A

A SIMPLE but attractive desk stand for 44-BX microphones. Finished in satin black. Diameter 7", height of 44-BX center above desk 8 $\frac{3}{8}$ ". For use with 74-B or 88-A microphones, the AP-4234 adaptor should be ordered extra. With the adaptor, the stand will be 6 $\frac{1}{8}$ " in height. Weight: 3 $\frac{1}{2}$  lbs.

## ◀ MI-4065-B BANQUET STAND

THIS smartly designed announce stand is designed for all of the RCA broadcast microphones except the aerodynamic for banquet or announce purposes. Finished in chromium and black. Takes  $\frac{1}{2}$ " pipe fitting. Height 8 to 10 $\frac{1}{2}$ ". Weight 3 $\frac{1}{2}$  lbs.



## MI-4068A LIGHT PROGRAM STAND ▶

THIS chromium and black stand is suitable for use particularly with the 74-B or 88-A microphones. It is equipped with a special clutch which eliminates thumbscrews and is adjustable in height from 35 to 67 inches. It is also useful for fixed remote installations. Fitting is for  $\frac{1}{2}$ " pipe thread. Weight 14 $\frac{1}{2}$  lbs.

## 59-B PORTABLE MICROPHONE STAND ▶

MI-4093

A STURDY lightweight collapsible stand for field use, featuring a tripod base and maximum portability. The height of the stand may be adjusted without operation of any release mechanism. A clutch similar to that used in the type 90-A program stand is employed. This stand is recommended for use with the 74-B, 77-B1, 87-C1, 88-A or 44-BX units.

Weight—3 $\frac{1}{2}$  lbs. Length when collapsed—approximately 36". May be extended from 36 to 60 inches. Has  $\frac{1}{2}$ " pipe thread. Finish—Satin Chrome.

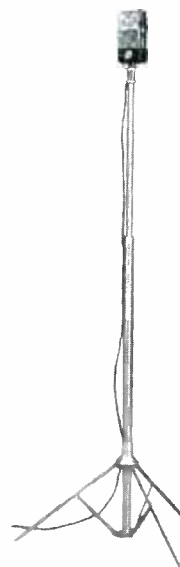

## THE 91-B DESK STAND

MI-4092

THIS is an attractively styled black and chromium base with a felt covered bottom. Two fittings are provided for using the stand with 88-A, 74-B, 77-B or 77-C microphones. Weight 4 lbs.



# RCA Microphones

Type No.	Operation	Use	Output Level*	Output Imped.	Frequency Response	Finish	Fitting
44-BX Velocity	Velocity	Studio	-49 db	50/250	30-15,000	Chromium & Black	1/2" Pipe Thread
74-B Junior Velocity	Velocity	Studio or indoor remotes	-50 db	50/250 15,000	70-8,000	Chromium & Black	1/2" Pipe Thread
77-B1 Uni-Directional	Uni-Directional Velocity	Studio or auditorium	-60 db	50/250/500	30-10,000	Chromium & Black	1/2" Pipe Thread
77-C1 Three-Way	Uni-Directional Bi-Directional Non-Directional	Studio or auditorium	-60 db -61 db -60 db	250/500 and 30/60	30-10,000	Chromium & Black	1/2" Pipe Thread
88-A Pressure	Pressure	Remotes	-50 db	50/250	60-10,000	Chromium & Black	1/2" Pipe Thread
MI-4017 Talkback	Pressure	Talkback	-39 db	250	200-2,500	Chromium & Black	Complete with Stand
30-A Lapel	Velocity	Speakers	-69 db†	250	80-7,000	Black	Clip
MI-6226-D Aerodynamic	Pressure	Talkback	-57 db	250 40,000	100-6,000	Chromium	1/8" Pipe Thread

(IMW. Zero Level)

\*10 dynes per sq. cm. sound pressure, open circuit. Output will be 6 db. lower when output is terminated into a matched load.

†Proximity to source results in output levels corresponding to those of other microphones.

See page 154 for chart on VU vs. power level.

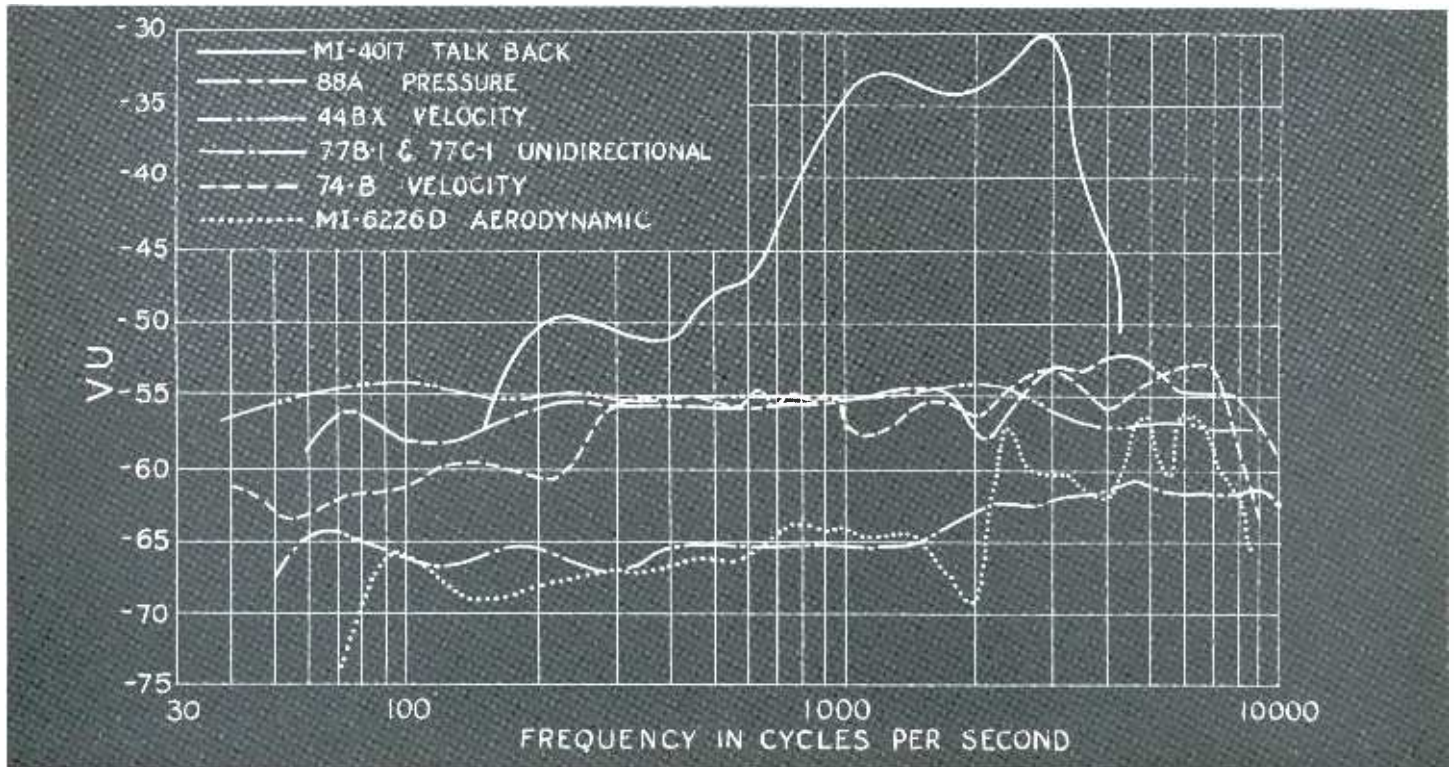

Frequency characteristic and relative output of RCA microphones

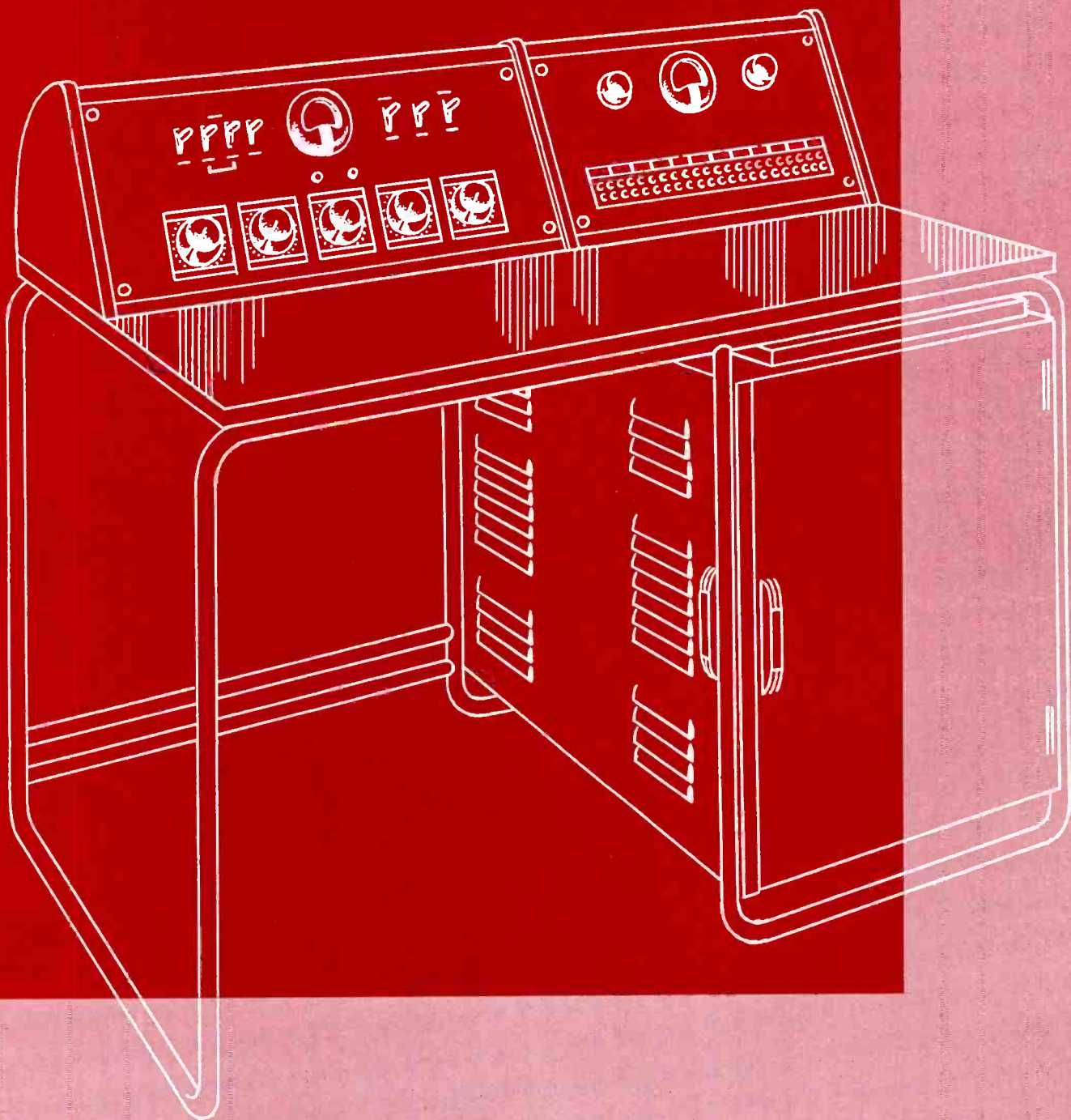

# SPEECH INPUT EQUIPMENT

# CUSTOM BUILT INSTALLATIONS

**R**CA "Custom-Built" equipments are complete speech input systems designed according to the requirements and specifications of individual stations. While standard panels and units are used, for the most part, in assembling these systems,—and the accumulated experience of RCA engineers, in building many such systems, called upon in their design—nevertheless, each system is different in one or more particulars. No two broadcast studio layouts are just alike,—and never, except perhaps in the smallest stations, are the equipment requirements exactly the same. Moreover, the bigger the installation, the more specialized the equipment problem. But, however large, or however modern, may be the requirements, RCA "Custom-Built" equipments can be furnished to meet them.

Moreover, the "Custom-Built" service means more than just so many racks or pieces of equipment,—it includes, in fact, the services of the whole RCA engineering organization. In some cases, for instance, the station or network engineers may wish to lay out the system themselves, complete with specifications. In such instances, RCA engineers will assemble standard units and, where necessary, specially-built units to meet these specifications in every detail. On the other hand, where stations so desire, RCA engineers will themselves study the requirements of the station, make overall and detailed layouts, and draw up specifications for the needed equipment.

◀ Type 2-A Desk built for CBS with view directly below it showing front and side open.

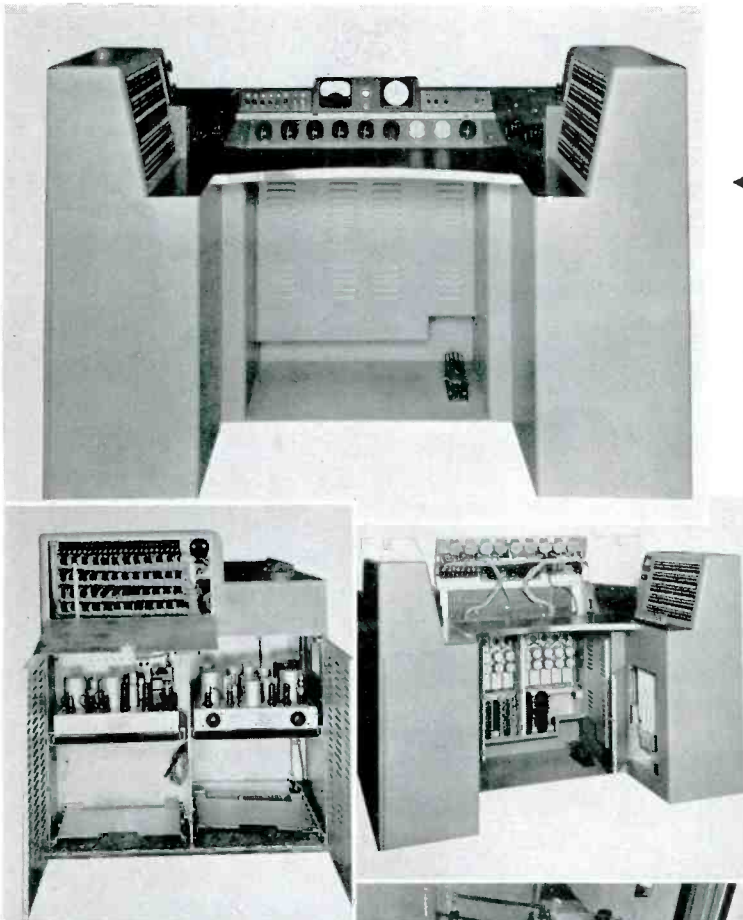

Master Control Room Speech Input at WLS.

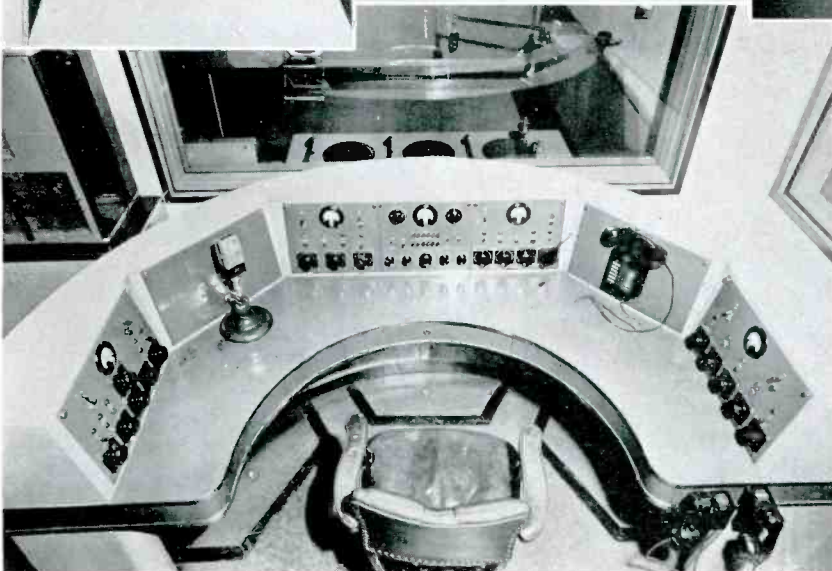

Above: Control Console at WWNC.

Right: Master Control at WIRE [www.americanradiohistory.com](http://www.americanradiohistory.com)



# A FEW OF THE MANY RCA CUSTOM BUILT INSTALLATIONS ARE SHOWN ON THIS AND THE PRECEDING PAGE

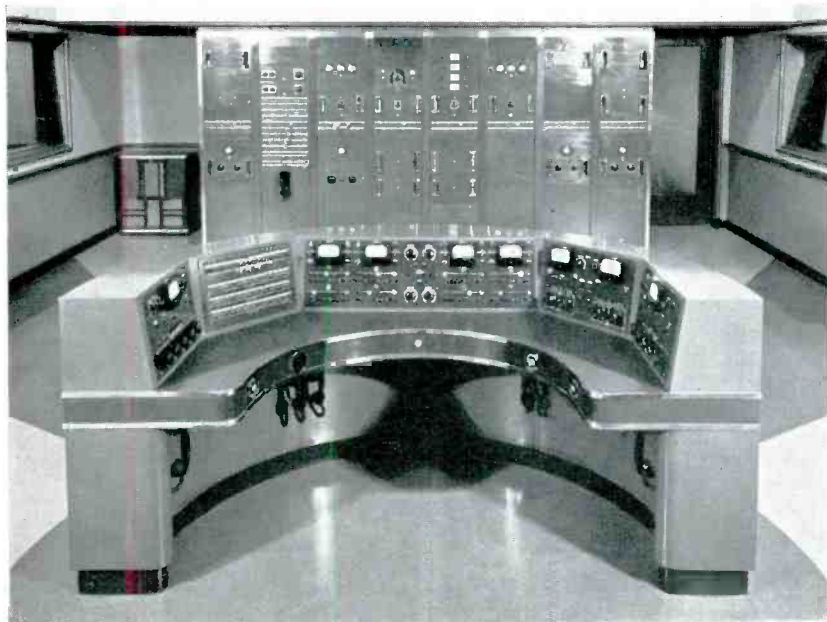

*Speech Input Master Control Desk, Racks and Monitoring Loudspeaker installed at WFBR, Baltimore, Md.*

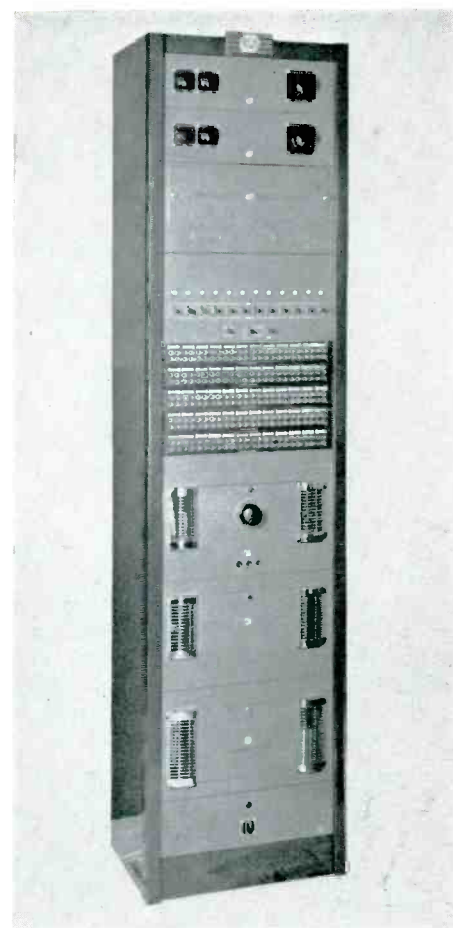

*Line Terminating Rack at WHBC, Canton, Ohio.*

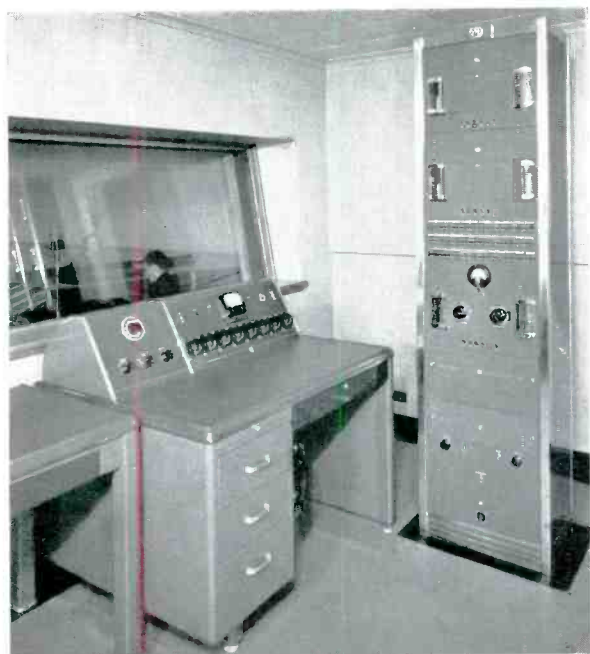

*A Studio Control Console and Rack built for WFBR, Baltimore, Md.*

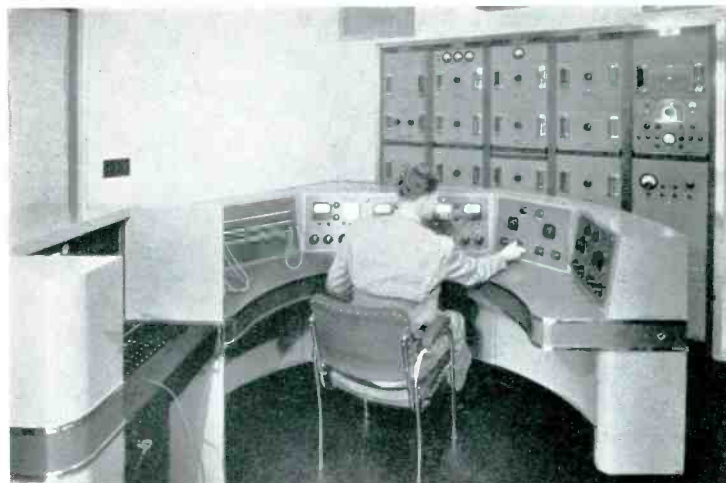

*Speech Input Master Control Desk and Racks employed at the Golden Gate Exposition.*

# TWO-STUDIO SPEECH INPUT EQUIPMENT

Rack: MI-4296D  
Console: MI-4647D } Umber Gray Finish  
Relay P. S.: MI-4308C }

## Type 78-B1

Rack: MI-4296C  
Console: MI-4647C } Black Finish  
Relay P. S.: MI-4308A }

THE TYPE 78-B1 Speech Equipment is a factory-assembled grouping of deluxe type panels, intended for use in the control rooms of small and medium-sized stations and for other applications requiring similar facilities. It consists of three units: a cabinet type rack on which are mounted the standard panel units which make up the systems; a sloping-front operator's console containing all of the mixing and switching controls; and a small wall-mounting unit which furnishes the 12 volt d.c. supply for the relays. The rack and console units are shown on this page. The streamlined and attractive appearance of these will be evident. Their modern "functionalized" design places unusual emphasis on efficiency in application, flexibility in location, and convenience in operation. In transmission fidelity they are unexcelled.

All of the unit panels used in the 78-B1 are of the deluxe type—and more detailed descriptions of these will be found on later pages. In addition to the 41-C Three-Channel Preamplifier, the 40-D Program Amplifier and the 94-D Monitoring Amplifier, there are two 33-A Jack Panels, a 57-A Switch Panel and a special relay panel. On the console are the four mixers, the main gain, the V. I. meter, and sixteen key switches. A plate current meter is mounted on the 40-D panel.

The outstanding feature of the 78-B1 is its provision for two-studio operation—including means of auditioning simultaneously with program transmission. A separate interlocked talk-back microphone is available for talking into either studio. A three-position switch allows the monitoring system to be placed across the program

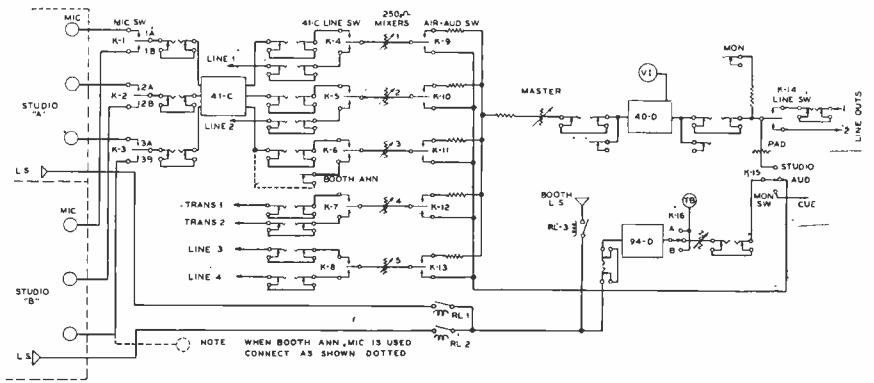

line output for regular monitoring; or, across a remote "cue" or transmitter output monitoring circuit.

The use of standard jack strips and a rack makes the 78-B1 very flexible for emergency setups or the addition of new equipment as required.

## SPECIFICATIONS

### Input Impedance:

Microphones (6) ..... 50 and 250 ohms  
Line and Transcription (6) ..... 250/300 ohms  
Talk Back Microphone (1) ..... 500 ohms

### Output Impedance:

Line (2) ..... 500/600 ohms  
Speaker (3) ..... 15 ohms

### Output Levels:

Line ..... +6 db.\* normal  
  +18 db.\* maximum  
Speakers ..... 12 watts normal  
  17 watts maximum

### Gain:

Microphone to Line ..... 101 db. maximum  
Microphone to Speaker (Monitor) ..... 133 db. maximum  
Microphone to Speaker (Audition) ..... 108 db. maximum  
Transcription to Line ..... 55 db. maximum  
Transcription to Speaker (Audition) ..... 62 db. maximum  
Talkback to Speaker ..... 75 db. maximum

### Frequency Response:

Microphone to Line — 1 to +2 db. 30 to 15,000 cycles  
Microphone to Speaker... ±2 db. 30 to 15,000 cycles

### Distortion:

+6 db.\* to Line,  
  less than 1% RMS, 50 to 7500 cycles  
12 watts to Speaker,  
  less than 2½% RMS, 50 to 7500 cycles

### Noise:

—60 db. below normal output with normal gain settings

### Power Input:

105-125 volts, 50-60 cycles, 250 watts

Finish: Black or Two-Tone umber gray. Brushed chrome rack trim.

\* Zero level=12½ milliwatts

# SINGLE STUDIO SPEECH INPUT EQUIPMENT

## Type 78-C1

**T**HE TYPE 78-C1 Studio Equipment is a deluxe assembly which is very similar in layout and appearance to the 78-B1 Equipment previously described. It differs, chiefly, in that it is arranged primarily for single studio operation. As such it is suitable for use in the individual studio booths of larger stations and in some cases in small station control rooms.

Like the 78-B1 it composes a standard cabinet type rack on which are mounted the unit panels, an operator's console and a relay rectifier.

Operating and switching arrangements of this equipment are shown in the diagram below. As will be noted, these amount to a simplified version of the 78-B1. The audition switching circuits are, of course, omitted, as are also the microphone input switches and there are only five mixer-input positions. However, talkback, cue and monitoring facilities are retained in full and in general the same degree of convenience and flexibility is provided. For those applications where only a single studio program is to be handled this equipment is unexcelled in any respect and is now being used by several prominent stations.

The 78-C1 can be easily arranged for four microphones by the addition of a 41-B Pre-amplifier for which wiring has been provided. A filter and switch permit the pre-amplifiers to obtain their plate voltage from the monitoring amplifier for emergency operation should a failure develop in the program amplifier. The high gain and excellent operating characteristics of the 94-D Monitoring Amplifier make it ideally suited for emergency use to replace the program amplifier and it may be quickly patched for this service.

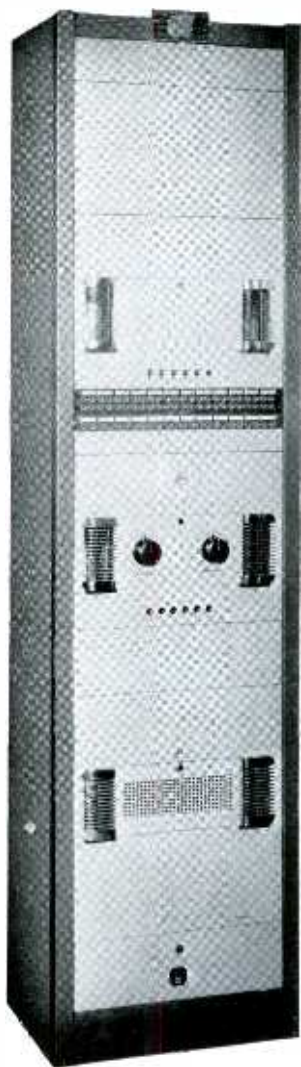

The operators console is designed for minimum height and is equipped with hinged front panel.

### STOCK NUMBERS

Rack: MI-4296E	} Black	Rack: MI-4296G	} Umber Gray
Console: MI-4647E		Console: MI-4647G	
Relay P. S.: MI-4308A		Relay P. S.: MI-4308C	

### SPECIFICATIONS

No. of Microphone Inputs: Three (50/250 ohms). No. of Other Inputs: Two, for additional microphone, transcription or line input. No. of Output Lines: (500/600 ohms) two. No. of Speaker Outputs: (15 ohms) three. Overall Gain: 101 db. Normal Output Level: 0\* db. Maximum Usable Output: +18\* db. Frequency Response:  $\pm 1$  db., 30 to 5000 cycles. Rises to 2 db. at 15,000 cycles. Output Noise Level: (at normal level) -60\* db. Distortion: (at normal level) 0.8 of 1%. Power Required: 105/125 volts, 50/60 cycles, 310 watts. Dimensions of Rack: 82 $\frac{7}{8}$ " high, 14 $\frac{3}{8}$ " deep, 20 $\frac{3}{16}$ " wide; Console, 25" wide, 15" deep, 12" high. Weight: Rack, 500 lbs., Console, 50 lbs. Finish: Black or Two-tone Umber Gray.

\* 0 db. = 12 $\frac{1}{2}$  milliwatts = +11vu.

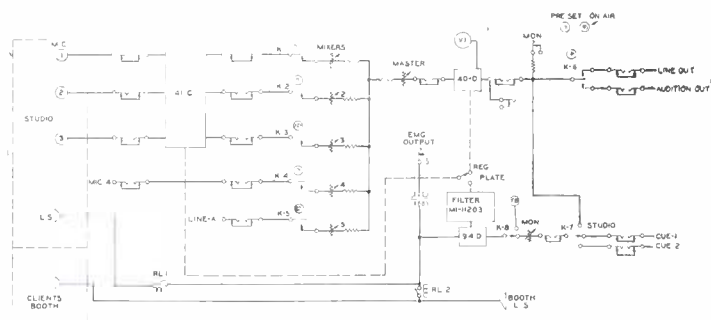

# SPEECH INPUT EQUIPMENT

## Type 76-B2

MI-11613A/11301A



**T**HE RCA 76-B2 has been designed to provide a complete and flexible speech input system for maximum economy. It provides all the amplifying and control equipment required to successfully handle two studios, an announce booth microphone, a control-room announce microphone, two transcription turntables, and six remote lines. Full facilities are provided for simultaneously auditioning and broadcasting from any combination of the studios, turntables or remote lines.

All the amplifying and control equipment is mounted in a single metal console and the power supplies are located in a metal box designed for wall mounting. Such an arrangement makes possible a quick and inexpensive installation which presents an unusually attractive appearance.

The 76-B2 is similar to the 76-B and 76-B1 Consolettes now giving highly satisfactory performance in over 100 broadcasting stations. It differs mainly in that its frequency response has been extended to 15,000 cycles. The noise and hum is -60 db. below the program level and the distortion is less than 1% R.M.S. at normal output. Thus the 76-B2 meets the performance requirements for FM as well as standard broadcasting.

The standardized, illuminated volume indicator meter is furnished calibrated in "vu's". This meter is also used to measure the plate current of all the tubes in the program channel. The meter is switched to the various tubes by means of the rotary switch on its left. An adjustable attenuator at the right of the meter allows the 100% mark on the scale to be calibrated for +4, +8, +12 and +16 vu.

The console contains four preamplifiers, one high-gain program amplifier and one high-gain 8-watt monitoring amplifier. A six position mixer is utilized with the preamplifiers connected to four of the mixers and banks of mechanically interlocked push-keys connected to the remaining two. The output of each mixer connects to lever keys so it may be switched to the input of the program amplifier for broadcasting or to the monitor amplifier for auditioning. These key switches are interlocked to disconnect the studio loudspeakers and operate "On Air"

light relays. A three position key switch in the input of the fourth preamplifier permits it to operate from a microphone in the studio, announce booth, or local control room. The push-keys on the fifth and sixth mixer positions allow any one of six remote lines and two turntables to be instantly connected to the input of either of the two mixers. Additional push-key sets provide circuits for feeding cue to remote lines and for bringing in monitoring circuits such as transmitter or master control outputs. A monitoring headset jack is supplied and the headphones may be connected to the output of the program channel, the remote line push-keys, or the incoming network by means of a three-position lever switch. Lever-key switching facilities are included for instantly using the monitoring amplifier for emergency operation should the program amplifier fail. Talk-back facilities are included and separate push-keys permit talking back to either of the two studios or to the remote lines. The talk-back circuits are interlocked to prevent feed-back or program interruption.

An "Override-Record" switch is provided which permits the remote operator to call in on any of the six remote

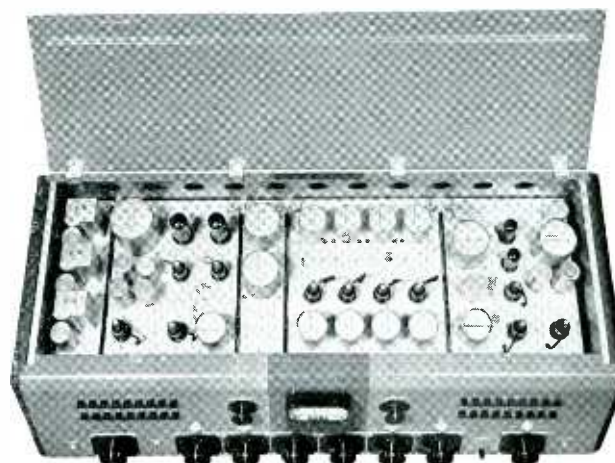

76-B2 with Top Raised



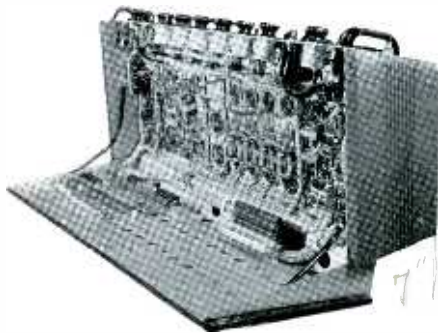

Components Easily Accessible with This Hinged Feature

lines and over-ride the program on the control room speaker. The "Record" position of the switch furnishes a signal source for an external recording amplifier. Two remote line repeating coils and attenuator pads are provided.

The console is constructed of metal with wooden style plates on each end. A lid is provided for access to tubes, etc. from the top and is equipped with sturdy concealed hinges. The entire console chassis is hinged across the back to permit quick and easy access to every component and all the wiring. Handles on the front panel facilitate opening the chassis for inspection. When the chassis is opened, all the mixers are conveniently arranged for servicing. This arrangement permits easy cleaning of the mixers without sacrificing the protection of the tight dust covers.

The power supply box is constructed of metal and is equipped with a hinged front door and a hinged chassis. It contains two separate rectifier and filter units. One rectifier is used for the program amplifier and the other for the monitoring amplifier. The preamplifiers are normally fed from the program amplifier's rectifier but a switch is provided for obtaining their plate voltage from the monitoring amplifier's rectifier in emergencies. The power supply also operates the three speaker interlocking relays. In addition, it is capable of operating 4 external

12 volt relays for studio "On Air" and "Audition" lights.

Accessory equipment for the 76-B2 includes the MI-11252 kit of tubes, the MI-11702 On-Air Light Relay, the MI-11703 Speaker Relay (not required unless an interlocked speaker is desired in the Announce Booth), the MI-64 shielded, twisted pair (No. 19) stranded cable and MI-65 shielded, twisted pair (No. 16) stranded cable.

## SPECIFICATIONS

Input (Source) Impedance: Microphones, 30/50 or 250 ohms; Remote lines, 300 or 600 ohms; Turntables, 250 ohms; Monitor Cue, 20,000 ohms. Output (Load) Impedance: Line, 500/600 ohms; Speaker, 15 ohms. Output Level: Line, +20 VU with less than 1% R.M.S. distortion at any frequency between 50 and 7000 cycles. Maximum output, +30 VU. Speaker, 4 watts with less than 2½% distortion at any frequency between 50 and 7000 cycles. Maximum output, 8 watts with less than 4% distortion. Gain: 110 db., maximum, mic. to line. Frequency Response: To Line, ±1 db. 40 to 10,000 cycles; ±2 db. 30 to 15,000 cycles. To Speaker, ±2 db. 30 to 15,000 cycles. Noise Level: -60 db. below output level. Power Input: 105/125 volts, 50/60 cycles, 225 watts. Tube Complement: 11 RCA-1620, 2 RCA-1621, 2 RCA-1622, 1 RCA-5U4G, 1 RCA-5Y4G. Dimensions: Console, 39" wide, 17" deep, 10½" high. Power Unit, 15" wide, 8" deep, 15" high. Weight: Console, 135 lbs., unpacked. Power Unit, 60 lbs., unpacked.



The two power supplies are contained in wall mounted ventilated steel box. Hinged door and chassis provide easy inspection and servicing.

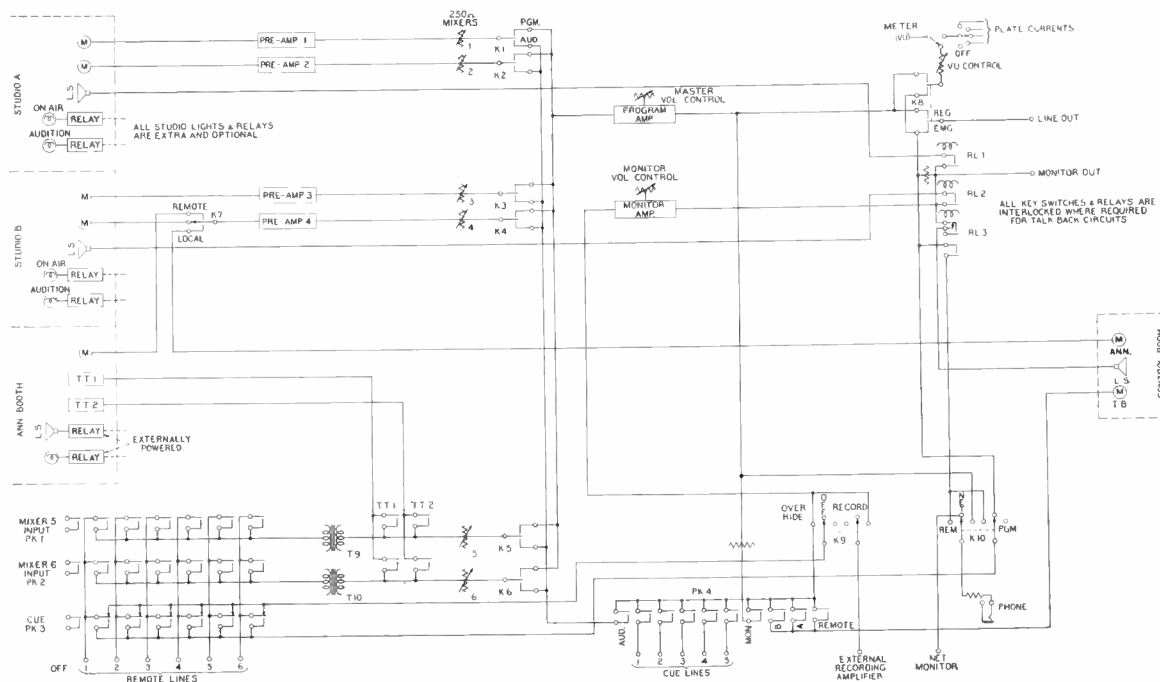

SIMPLIFIED BLOCK DIAGRAM OF 76B2 CONSOLETTTE

# CONTROL DESK

## Types

### 80-B and 80-BX

MI-11604B BLACK  
MI-11604C UMBER GRAY

MI-11604D BLACK  
MI-11604E UMBER GRAY



**I**N THE TYPE 80-B and 80-BX Control Desk, RCA has designed a unique speech input unit primarily planned for single studio operation. It fulfills the needs of a complete studio booth equipment for stations using several studios and master control room. It is also useful for installations in playhouses and remote studios. A double-throw key switch on the input of each of the four mixers permits switching to studio pre-amplifiers, turntables or remote lines. A monitor cue selector switch permits the operator to choose his cue from the preceding program on his individual channel. The complete desk is about the size and shape of a modern frame desk. It is beautifully finished in black and chromium, or umber gray and chromium. The switches and controls are mounted on panels in a metal turret comprising the upper part of the desk. The control panels remove easily for servicing. All meters and control knobs are of the proper angle and height for convenient operation. The rear of the turret control is rounded to provide visibility into the studio. The left hand control panel contains the mixers, the illuminated VI or VU meter, and all program circuit key switches. The monitoring volume control, monitoring selector switch, plate current indicator, meter and a double jack panel are located on the right hand panel.

A sliding writing shelf is mounted in the right hand side of the desk for the convenience of the program di-

rector and others. Below the shelf is a ventilated metal compartment which houses all the amplifiers and relays.

The amplifiers employed in the type of desk are of a standard type and not of special manufacture. A MI-4308 Relay Rectifier is furnished.

The 80-BX is essentially the same as the 80-B except that the large square type VU meter is employed, calibrated on the basis of 1 MW. The VU meter is illuminated.

## SPECIFICATIONS

Gain (Maximum): Microphone to line, 110 db. Line to line, 80 db. Cue to speaker, 28 db. Line out to speaker (monitor), 28 db. Talk back to speaker, 80 db. Gain Controls: 250 ohms step by step ladder pads for mixer and master. Input Impedance: Microphones—250 and 30 ohms balanced. Lines, 250 ohms. Talk back, 250 ohms balanced. Cue, 10,000 ohms balanced. Output Impedance: Line, 500/600 ohms balanced, monitor 15 ohms. Output Level: Line +21 VU normal +31 VU (maximum). Monitor 4 watts normal, 8 watts maximum. Distortion: Line—less than 1%. R.M.S. at normal output over band between 50 and 7000 cycles. Monitor less than 2.5%. R.M.S. at normal output over band between 50 and 7000 cycles. Noise Level: With normal gain settings —60 db. Frequency Response: Line:  $\pm 1\frac{1}{2}$  db. from 1000 cycles response between 30 and 10,000 cycles. Monitor:  $\pm 2\frac{1}{2}$  db. from 1000 cycles. Response between 30 and 10,000 cycles. Note: By the addition of an MI-4313A compensator the monitor amplifier may be compensated +6 db. at 60 and 10,000 cycles. Power Supplied to External Devices: 110 V—DC from one to three 100 milliamperere loudspeaker fields. 12 V—DC for "on air" light relays. Power Supply: 105/125 V—50/60 cycles. 250 watts 90% P. F. including 30 watts for speaker fields. Tube Complement: 7 RCA-1603, 1 RCA-6C6, 2 RCA-89, 2 RCA-76, 2 RCA-6L6G, 1 RCA-80, 1 RCA-5Z3, 1 relay rectifier tube stock No. 20801. Weight of Desk: 200 lbs. Relay Rectifier 17 lbs. Dimensions: Height of table 30", overall 40 $\frac{1}{2}$ ", width 50", depth 30". Rectifier height 10", width 8", depth 5".

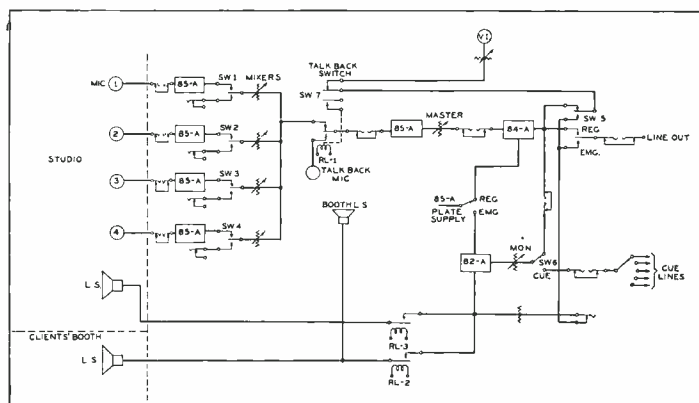

# DE LUXE SPEECH INPUT UNITS

THE RCA Deluxe Line of speech input equipment has been designed to provide stations with studio equipment which would offer the maximum in fidelity, flexibility, convenience and reliability. While the apparatus is truly deluxe in performance and appearance, it is not expensive considering the many features which are offered. It has been designed primarily for unsurpassed service and nothing has been omitted which would contribute to usefulness and reliability, yet cost has been watched carefully in order to provide the desired features without excessive expense.

The deluxe amplifiers feature fidelity of the highest order. Frequency response is uniform, not only over the usual range to 10,000 cycles; but to 15,000 cycles as well. Distortion has been reduced to a point which would have been considered impossible for commercial apparatus a few years ago—note the curve shown below. Noise level is well below —60 db. Thus the apparatus provides for incomparable fidelity standards which are not likely to be exceeded by any commercial equipment for many years.

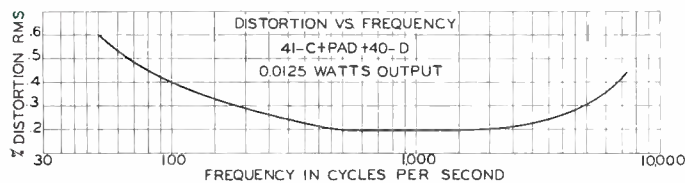
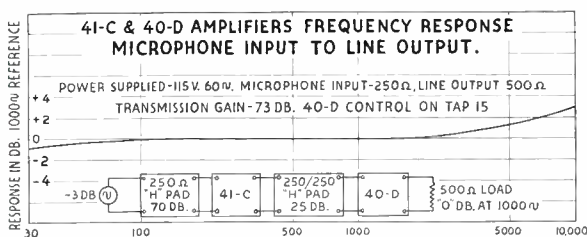

Curve showing distortion vs. frequency 41-C + Pad + 40-D

The equipment has been provided with components which are unusually heavy and which have a

larger factor of safety than normal. Resistances and capacitors are the best which can be obtained for the purpose, tested under conditions which assure trouble free service. Transformers are large in order to avoid low frequency distortion and are provided with particularly efficient shielding. Gain controls are all of the tapped type with individual fixed resistor units constructed to avoid noise during operation and tested for thousands of cycles of use.

These are supplied with hinged chassis units which allow the entire unit to be tipped to the rear, exposing the under portion for inspection. Thus it is unnecessary to remove the panel from the rack once it has been connected up. Tubes are easily reached through a door in the front panel. Plate currents of tubes can be read by operating push-buttons. Even the terminal strips are of a type which facilitate wiring.

Appearance has been considered important to increase the prestige of the station. The front panels are treated with chromium styling which also forms louvres to furnish ventilation and to keep all parts at a conservative temperature. Chassis and components are heavily plated to provide an attractive appearance and to prevent dust from sticking. Panel finish is uniform and of the highest grade.

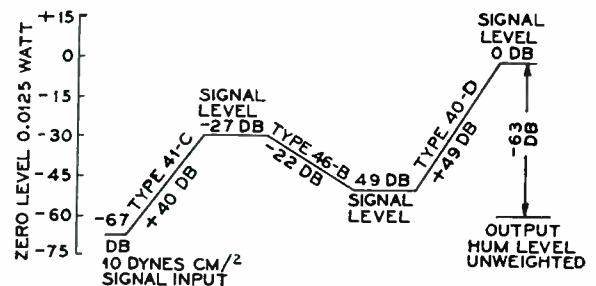

Signal levels for deluxe system

# THREE-CHANNEL PRE-AMPLIFIER

## Type 41-C

MI-4206

### *A DeLuxe Unit Incorporating Three Complete Pre-Amplifier Channels*

ALL of the high-quality microphones developed to date have relatively low output and are, therefore, ordinarily used with preamplifiers designed to raise these outputs to a satisfactory mixing level. The Type 41-C Preamplifier is a unique unit which provides the preamplification facilities ordinarily needed for a complete speech input channel. It contains three separate preamplifiers, each complete and independent of the other, save for power supply. These preamplifiers may be used exactly as if they were three separate units. Since the usual speech input channel consists of three microphone inputs, plus transcription and line inputs—which do not require preamplifiers—the Type 41-C should take care of all ordinary needs.

Prime requirements in a preamplifier are low noise-level and freedom from microphonics. In the Type 41-C these are assured by use of RCA-1603 "low-noise" tubes, provision of extra-large bypass condensers, and by shock mounting of tubes. Each preamplifier channel consists of two stages—RCA-1603's triode-connected. Taps are provided so that the gain of each channel may be set at either 42 db. or 48 db. Input impedances of 50 ohms or 250 ohms are available from alternate connections.

Characteristics of the Type 41-C Preamplifier are exceptional. The frequency response is flat from 30 to 5,000

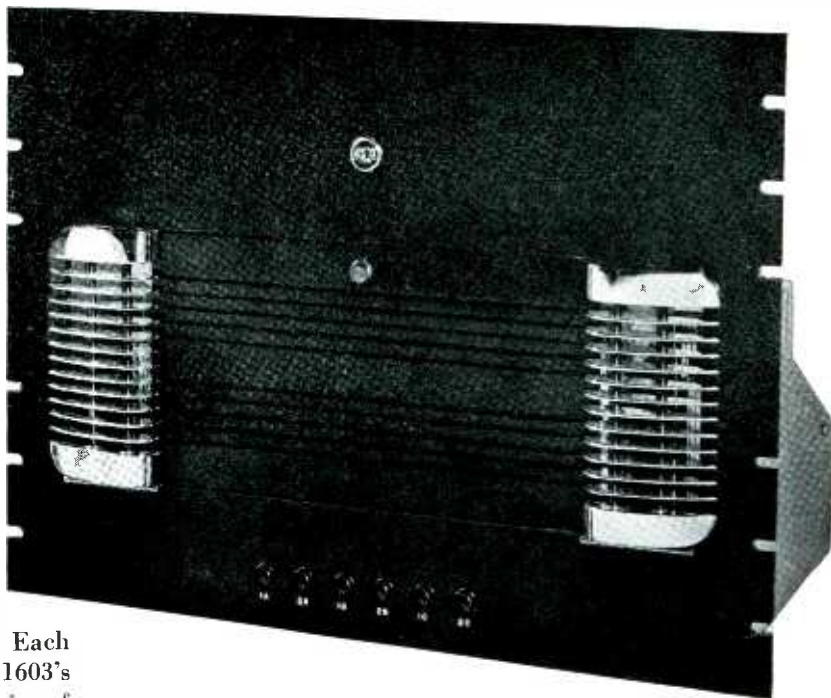

cycles, and beyond 5,000 cycles rises gradually to 16,000 cycles. This provides for an overall characteristic (of the channel when used with the Type 44-BX Microphone) uniform from 30 to 15,000 cycles. Distortion is less than 0.2% arithmetic sum, while the noise level (unweighted) is  $-87$  vu db. in the low-gain position, and  $-79$  vu in the high-gain position. The Type 41-C Preamplifier has input impedances to match any high-quality microphone. In addition to the normal high-fidelity characteristics, consideration has also been given to the necessity of providing a wide dynamic range without overloading. Thus an input of 400 bars (which, with the Type 44-BX Microphone, would result in an output of  $+8$  vu) can be handled without exceeding ordinary distortion limits. This is an important factor wherever programs rising to high levels are to be met with.

### SPECIFICATIONS

No. of Channels: three. Input Impedances: 50/250 ohms. Output Impedances: 250/500-600 ohms. Gain (Each Channel): 42/48 db. Normal Output Level: 16 vu db. Max. Usable Output: 0 vu. Output Noise Level: (unweighted)  $-87/79$  vu. Distortion (Arith. Sum): at normal output, 0.2%. Frequency Response: 30 to 16,000 cycles. Power Required: 6.3 volts, 1.8 amp.; 180 v., 12 m.a. (180 v. obtainable from 40-D or 40-C). External filament transformer supplied. Panel Height:  $13\frac{3}{8}$ ". Weight: 61 lbs. Tubes: 6 RCA-1603.



Rear View of 41-C.

# DE LUXE PROGRAM AMPLIFIER

Type 40-D . . . A High Performance Unit  
Featuring A Vacuum-Tube Volume Indicator

MI-4295A

THE TYPE 40-D Amplifier is a highly-perfected equipment which combines the functions of main amplifier and volume indicator. Thus it includes a three-stage low-distortion amplifier having a relatively high output and, in addition, a three-tube volume indicator of special and unique characteristics.

The program or studio amplifier is properly the heart of the speech input channel. Where failure of other units will only handicap the speech system, the failure of the studio amplifier requires shut down or substitution of another amplifier. In the Type 40-D Amplifier proven circuits and circuit components have been utilized to insure utmost reliability. The first stage uses an RCA-1603 "low-noise" tube, pentode-connected; the second stage, an RCA-1603, triode-connected; and the final stage, a pair of RCA-89's push-pull. The use of three stages makes possible an overall gain of 75 db. (equal to the combined gain of the line and monitoring amplifiers of some systems) —thereby providing a margin which gives desirable flexibility and furnishes a means of caring for emergency requirements. A volume control, connected interstage, allows adjustment of gain in 20 steps of 2 db. each.

The V. I. system incorporated in the 40-D Amplifier is unusual, in that it provides a method of reading levels which is at once more easy and more accurate than older methods. The three-tube circuit provides a "floating" indication similar to that of the FCC-approved modulation

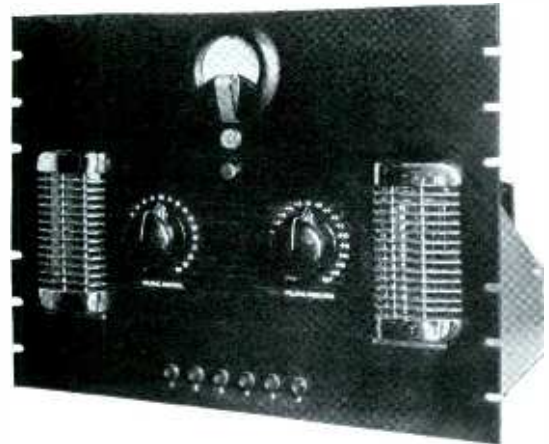

Front View of the DeLuxe 40-D Showing RCA's Modern Illuminated Meter Design Which Features Easy Bulb Replacement

monitors. The needle swings up very rapidly, but returns slowly, thus allowing easy reading. Such action gives much the same impression to the eye as do sound levels to the ear. The V. I. circuit may be connected to operate alternatively as a conventional measuring circuit. However, in either case the additional amplifier tubes furnish isolation from the program circuits which is exceedingly desirable. The illuminated V. I. Meter provides readings throughout a range of  $-20^*$  db. to  $+18^*$  db.

Performance characteristics of the Type 40-D Program Amplifier, like those of the Type 41-C Preamplifier, are exceptionally good. The frequency response is flat from 30 to 17,000 cycles, distortion is less than 0.2% arithmetic sum, and noise level is  $-60$  db. below output level (unweighted). While the normal output level is 0 db., the amplifier will provide a  $+18$  db. output without exceeding ordinary distortion limits, thus providing for transmission of a wide dynamic range.

## SPECIFICATIONS

Input Impedances: 250/500/600 ohms. Output Impedances: 250/500/600 ohms. Overall Gain: 75 db. Normal Output Level: 0\* db. Max. Usable Output:  $+15^*$  db. V. I. Range:  $-20^*$  db. to  $+18^*$  db. Output Noise Level at Normal Output: (55 db. gain)  $-70^*$  db. Output Noise Level at Normal Output: (full gain)  $-60^*$  db. Distortion: (Arith. Sum) at normal output, 0.2%. Frequency Response: 30—17,000 cycles,  $\pm 1$  db. Power Input: 85 watts. Panel Height:  $13\frac{3}{32}$ ". Weight: 61 lbs. Tubes: 2 RCA-1603, 2 RCA-89, 1 RCA-25Z5, 1 RCA-6A6, 1 RCA-76, 1 RCA-84. Supplies 180 v. 12 ma. for preamplifiers.

\* 0 db. =  $12\frac{1}{2}$  milliwatts =  $+11$  vu



Rear View of 40-D. Substantial Hinges Allow Quick Chassis Opening for Inspection

# DE LUXE BRIDGING AMPLIFIER

## Type 55-B

MI-4215

### *The Ultimate in Line Amplifiers*



**T**HE RCA 55-B is a bridging or line amplifier useful for isolating a program channel from an outgoing line. Where a single program is fed to several points, such as to a network, a local station and to a short wave transmitter, it is important to prevent any one of the lines from affecting the others. The 55-B has been designed for isolating lines but it is also valuable for other purposes where a gain of 45 db. is required.

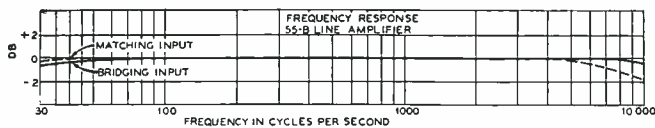

Like other amplifiers of the deluxe line, the 55-B is provided with streamline ventilation louvres and with a hinged chassis to allow for easy access. Pushbutton reading of plate currents is also included. The 55-B is supplied

with a gain control to facilitate setting levels for various lines.

The circuit of the 55-B employs an RCA-1603 in the first stage, driving two RCA-89's in push pull as an output amplifier. Transformer coupling is used throughout. An integral power supply is included using an RCA-80 rectifier. Input terminations provide for bridging or line matching connections and the output is either 600 or 250 ohms. Both hum level and distortion are low and the frequency response is uniform over the range of 30 to 10,000 cycles.

Because the output may be used as high as +30 vu, the 55-B may also be employed as a monitor amplifier or as a voltage amplifier to drive individual power amplifiers for loudspeaker operation.

The use of the 55-B insures a reliable, high fidelity amplifier for feeding outgoing programs to lines, and is ideally suited for use at stations feeding more than one outgoing channel.

### SPECIFICATIONS

Input Impedances: 500/600 or 20,000 ohms. Output Impedances: 250 or 500/600 ohms. Overall Gain: 47 db. for 600-600 ohms, 30 db. bridging 600 line. Normal Output Level: +11 vu. Maximum Usable Output: +27 vu. Noise Level: -52 vu. Distortion: below 0.3% RMS at normal output level. Frequency Response: Matching  $\pm 2$  db. 30 to 10,000 cycles. Bridging:  $\pm 2$  db. 30 to 15,000 cycles. Power Input: 57 watts, 110 volts, 60 cycles. Panel Height: 10 $\frac{1}{2}$ ". Weight: 43 lbs. unpacked. Tubes: 1 RCA-1603, 2 RCA-89, 1 RCA-80.



# DE LUXE MONITORING AMPLIFIER

## Type 94-D

MI-4270

### 17 Watts with Low Distortion, High Gain

THE RCA Type 94-D Monitoring Amplifier is the newest of the well known RCA 94 series of amplifiers—recognized throughout the radio industry as the ultimate in high quality monitoring equipment. The 94-D features high gain with large, undistorted output, which makes it an unusually flexible amplifier, adaptable to a wide variety of applications. Because it uses the new RCA deluxe mechanical assembly, it is one of the most readily serviced and attractive monitoring amplifiers on the market. Because it utilizes the new beam power tubes in an efficient

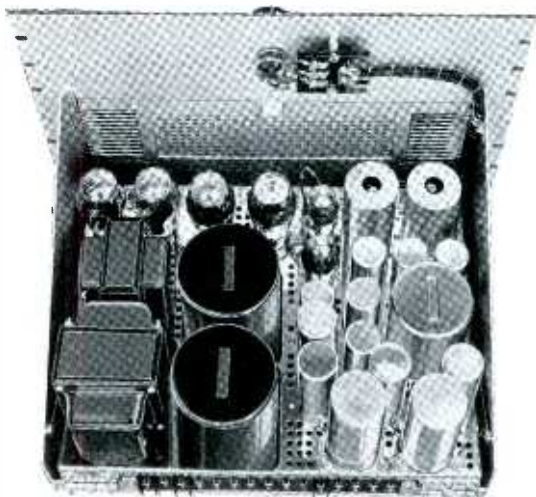
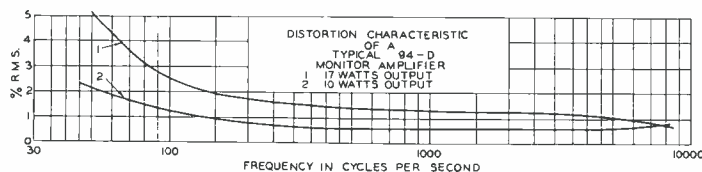
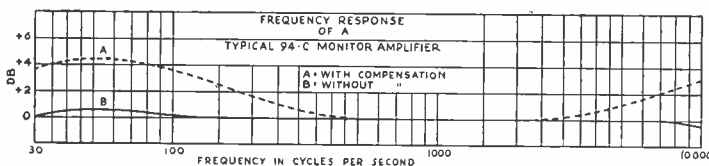

resistance coupled circuit with degenerative feed-back, it is capable of an output power of 17 watts with unusually low distortion content.

A separate power supply is included in the 94-D for furnishing field current to one or two 56 volt or 110 volt loudspeaker fields. When the speaker field supply is not used, the power input is reduced accordingly and no reactors are required. A compensator circuit gives a 5 db. boost to the low and high frequency ends of the audio band to compensate for the losses normally introduced by the loudspeakers. When the 94-D is used with RCA Type 64-A or UZ-4209 loudspeakers an overall response is obtained which is practically flat over the range of 50 to 12,000 cycles. The compensation may be readily disconnected to provide a flat response if desired.

A bridging type volume control is provided which has an input impedance of 20,000 ohms, an output impedance of 500 ohms and a variation in control of 46 db. This control may, if desired, be mounted externally at a distance from the amplifier.

### SPECIFICATIONS

Input Impedance: 20,000 ohms or 500/600 ohms with input control. Output Impedance: 500/600, 15, 7.5, 5 ohms. Overall Gain: 80 db. (600-600 ohms) 48 db. (20,000-600 ohms), 42 db. (bridging with remote gain control). Maximum Output Level: 17 watts. Noise Level: -24 to -28 VU. Distortion: Less than 3% RMS at 17 watts output for any frequency between 100 and 7,000 cycles. Frequency Response: Rising 5 db. at 50 and 15,000 cycles or within  $\pm 2$  db. 30 to 15,000 cycles. Power Input: 100 to 130 volts, 50 to 60 cycles, 150 watts without field supply. Panel Height: 14 inches. Weight: 72 lbs. Tubes: 4 RCA-1603, 2 RCA-6L6G, and 2 RCA-5Z3. (Only one 5Z3 required if speaker field supply is not used.)

# STANDARD PRE-AMPLIFIER Type 41-B

MI-4205E

*A Single Channel Pre-Amplifying Unit for High Quality Microphones*



THE TYPE 41-B Pre-amplifier is the standard two-stage single-channel amplifier used in RCA speech systems for several years past. Occupying a position between the 41-C Pre-amplifier of the de luxe line and the 85-B Pre-amplifier of the economy line, it meets the requirements of a number of special applications—not only as a replacement item, but in many new installations; for instance, in de luxe systems where more channels are required than are provided by the 41-C. Or again, where only one or two channels are required, as in agency auditioning setups, or the like. For such uses it provides reproduction quality unexcelled throughout the usable band (30-15,000 cycles), maximum reliability, conveniences such as front access to tubes, and an appearance which allows it to be used with standard, de luxe or economy type installations.

Because of the extremely low signals handled by pre-amplifiers, microphonics and hum background must be exceptionally low. The Type 41-B Pre-amplifier is designed to meet these requirements. The input circuits are heavily shielded to prevent noise pickup—while the RCA-1603 Radiotrons used in both stages of the amplifier are exceptionally free from microphonics and hum. Standard input and output impedances are used, so that the amplifier may be used with any type of microphone where a fixed gain of about 40 db. is required. The output as normally used is  $-16$  vu, but may be as high as  $+14$  vu without causing distortion to exceed ordinary limits. Filament power is obtained from a separately mounted transformer which is furnished. The required plate supply (5 ma. at 180 volts) is ordinarily obtained from a tap on the rectifier of the Type 40-C Amplifier.

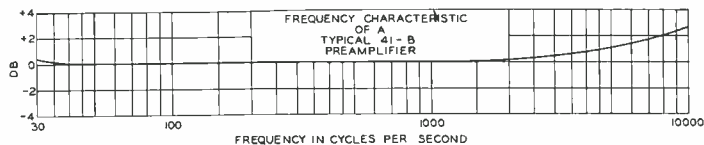

## SPECIFICATIONS

No. of Channels: one. Input Impedances: 67.5/250 ohms. Output Impedance: 250/500/600 ohms. Gain: 52/48 db. Normal Output Level:  $-16$  vu. Output Noise Level:  $-77$  vu. Distortion (Arith. Sum): at normal output .4 of 1%. Frequency Response: 30 to 15,000 cycles. Power Required: 6.3 volts, 0.6 amp.; 180 volts, .004 amp. Panel Height:  $5\frac{1}{4}$ ". Tubes: 2 RCA-1603. Net Weight: 25 lbs.

# Type 15-B STANDARD METER PANEL

MI-4309A



THE 15-B Meter Panel has been especially designed for use with the RCA Standard Line of speech input units. A patch cord is furnished with the 15-B for taking plate current readings and a two-way switch is provided for measuring the plate voltage from two sources. The A.C. meter is permanently connected in the circuit. The milliammeter has a push-button providing two current ranges. When this meter panel is used with the 40-C and 41-B

amplifiers, routine checking is easily accomplished, and in case of tube failure the defective unit can be located almost immediately.

## SPECIFICATIONS

D.C. Voltmeter.....0-250 Volts  
 D.C. Milliammeter.....0-10 and 0-100 MA.  
 A.C. Voltmeter.....0-150 Volts  
 Dimensions.....19" wide,  $5\frac{1}{4}$ " high, 4" deep  
 Weight (unpacked).....9 lbs.



# STANDARD PROGRAM AMPLIFIER

## Type 40-C

MI-4292C

*A Time Tested Unit of Proved Performance and Reliability*



**T**HE TYPE 40-C Program Amplifier is an all-purpose unit which, like the Type 41-B Preamplifier, has proved its worth in hundreds of stations from coast to coast. For use as a replacement in, or addition to, standard type speech systems, it is unexcelled. It has characteristics bettered only by the deluxe Type 40-D Amplifier and like the latter, it includes a built-in V. I. system (rectox type) and a power unit with connections for sup-

plying plate voltages to preamplifiers. While it does not have the deluxe construction, the mechanical design follows time tested lines proven reliability and convenience.

The amplifier proper includes three stages, triode connected RCA-1603's in the first two stages and RCA 89's push-pull in the output stage. This line-up provides an overall gain of 69 db. and while the normal output is of the order of zero db., the amplifier can furnish an undistorted output of +16 db.\* The gain control provides 38 db. attenuation in steps of 2 db. The volume indicator—of the copper-oxide type—is of the standard type calibrated from -6\* to +18\* db.

The rectifier uses an RCA-25Z5 in a voltage-doubler circuit, thus eliminating the usual plate transformer and reducing the likelihood of hum introduction. Besides providing plate voltage for the Type 40-C Amplifier itself, this rectifier also has taps supplying plate voltage for up to three Type 41-B Preamplifiers with suitable plate filter circuits.

### SPECIFICATIONS

Input Impedances: 250/500/600 ohms. Output Impedances: 500/600 ohms. Overall Gain: 69 db. Normal Output Level: 0 db.\* Max. Usable Output: +15 db.\* V. I. Range: -8 db.\* to +20\* db. Output Noise Level: -60 db.\* Distortion (Arith. Sum): 0.25% at normal output of 0 db.\* Frequency Response:  $\pm 1$  db. 30 to 10,000 cycles and  $\pm 2$  db. 30 to 15,000 cycles. Power Input: 75 watts, 105/125 volts, 25/60 cycles. Panel Height: 13 $\frac{31}{32}$ ". Weight: 58 lbs. Tubes: 2 RCA-1603, 2 RCA-89, 1 RCA-25Z5.

\* 0 db. = 12 $\frac{1}{2}$  milliwatts = +11 vu.

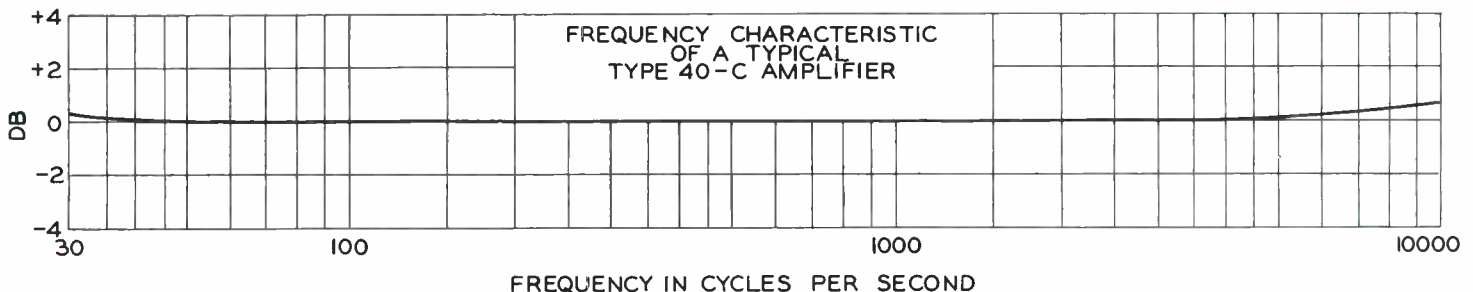

*Frequency characteristic of a typical Type 40-C Amplifier*

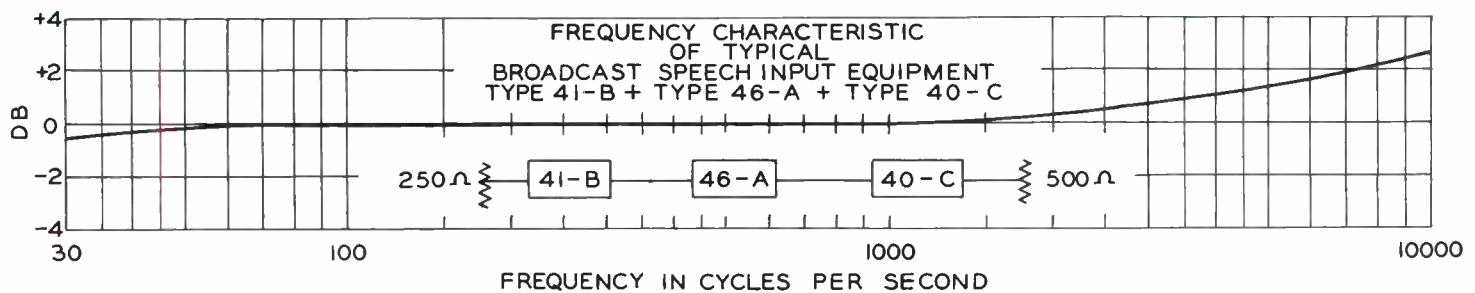

*Frequency characteristic of typical Broadcast Speech Input Equipment*



# ECONOMY LINE SPEECH INPUT EQUIPMENT

THE "Economy" line has been developed for installations where cost is an important factor but where high quality and fidelity must be maintained. It consists of a complete set of amplifiers for any size of studio installation. The low price of these units is in no way a reflection upon their reliability and operating performance but is the result of careful engineering design. The latest circuit developments, utilizing the best tubes available, have been employed.

Costs have been held to a minimum by omitting deluxe features and by using a simple mechanical design. An installation using RCA "Economy" line units benefits economically because of the low initial cost and because more units can be mounted in less space than with regular speech input equipment. An example of installation possibilities of these units is demonstrated by the Type 80-B Studio Desk shown on a preceding page. The units employ a chassis type construction and are carried in stock without panel mountings. For rack mounting, either the 36-A or 36-B Panel and Shelf Assemblies should be used.

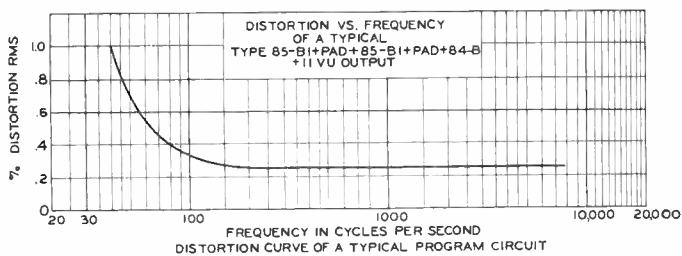
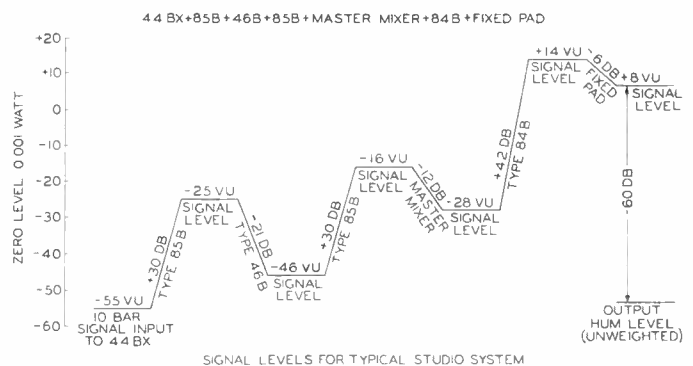
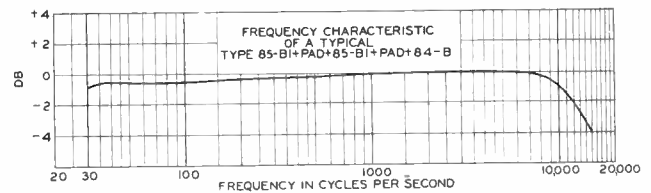

*Distortion Curve of Program Circuit*

The fidelity characteristics of the RCA "Economy" amplifiers are shown in the adjoining curves which represent actual measurements on speech input systems employing units of the "Economy" line. It should be noted that an essentially flat frequency characteristic is obtained from 30 to 10,000 cycles and that the low distortion given in the component amplifier specifications is not just a 400 cycle measurement but for the entire audio band between 50 and 7000 cycles. Also the noise specifications include all unweighted noise components in the output and not only the A. C. hum.

# MICROPHONE PRE-AMPLIFIER TYPE 85-B1

MI-11207A

THE TYPE 85-B1 Preamplifier is an extremely small, single-tube, high-fidelity microphone pre-amplifier. It has been designed to obtain the maximum gain from the especially developed RCA 1620 tube. Its compact size and low price adapts it to many uses, such as a transcription turntable booster or a booster on the input of the monitoring amplifier to adapt it to low level audition work. Because of the small size and neat mechanical design, considerable flexibility is possible with regard to the installation, since these preamplifiers may be mounted directly in the control console or control desk and thereby eliminate many long leads. The mounting flexibility also applies to rack and panel installations where one to six 85-B1's may be mounted on a single 36A or 36B panel. An additional 85-B1 is usually used as a "booster" amplifier preceding the "master" mixer to provide for low noise to signal ratio. Employing such a system a five channel, high-level mixing, speech input system can be economically installed by using six (one as master booster) 85-B1 preamplifiers all of which could be mounted on one panel.

The audio transformers for the 85-B1 Preamplifier were especially developed and designed by RCA Engineers for this application. They feature small size without sacrifice of important operating characteristics and reliability. A recently developed type of shielding cover surrounds the transformer to prevent hum pickup. The tube in the 85-B1 mounts vertically and is properly shock mounted to prevent microphonics. A filament transformer (MI-11606) is available on separate order and is capable of furnishing filament power to six 85-B1 Preamplifiers. Plate voltage is usually obtained from the program amplifier (84-B) but if none is available the RCA MI-11302 or MI-4303 Power Supplies are recommended.



85-B Preamplifier with terminal board cover removed

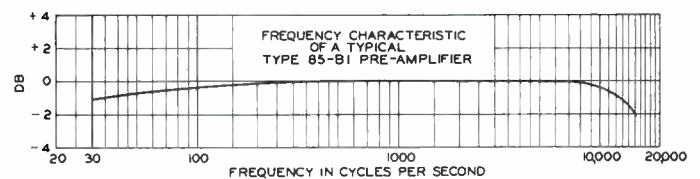

## SPECIFICATIONS

Input Impedance: 30/50 and 250 ohms. Output Impedance: 600/500 and 250 ohms. Max. Input Level: -30 VU for 1% distortion. Output Level: -0 VU with 1% RMS distortion. Transmission Gain: 30 db. Frequency Response:  $\pm 1$  db. from 100 to 6000 cycles and  $\pm 2$  db. from 30 to 15,000 cycles. Distortion: 0.3% RMS at normal output of -16 VU. Noise Level: -92 VU. Tube Complement: 1 RCA-1620. Power Supply: 180 to 250 volts DC at 3.1 MA for plate, and 6.3 volts AC or DC at .3 Amp. for filament. Weight: 4 lbs. (unpacked). Dimensions: (over all)  $2\frac{1}{2}$ " wide x  $12\frac{1}{2}$ " deep x 6" high. Finish: Silver gray opalescent.

NOTE: For rack mounting use 36-A or 36-B Panel and Shelves.

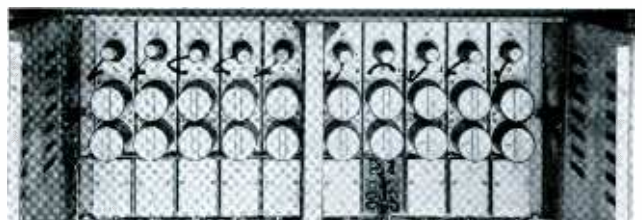

Ten RCA-85-B Preamplifiers mounted in CBS Type 2-A Studio Control Desk

# ISOLATION AMPLIFIER TYPE 85-X

MI-11208

The Type 85-X Isolation Amplifier is a single stage unit which has been designed for use in audio circuits requiring an isolation device. When used to bridge program circuits its output may be fed into monitoring busses so that the loudspeaker amplifiers may be switched between the various monitoring circuits without clicks feeding back into the program. The 85-X is ideally suited to such an application because of its low price, small size, flat frequency response and low distortion. Six 85-X's may be mounted on one 36-A or 36-B panel. When bridging a 600 line and working into a 600 monitoring buss, it performs as a no-gain no-loss device with a backward attenuation or isolation of 60 db. The volume control is in reality a feedback control, less than normal feedback increases the gain while greater than normal feedback (16 db.) decreases the gain. When the amplifier is connected for bridging input, the volume control will vary the gain from -3.5 db. to +4 db. through a normal setting of 0 db. With matching input, the gain may be varied from 12 db. to 20.5 db. Thus the maximum possible feedback consistent with the required gain is always utilized.

The power input requirements can be furnished from the MI-4303 or MI-11302 power supplies and the RT-386 (MI-11606) Filament transformer.



## SPECIFICATIONS

Input Impedance.....	600 and 20,000 ohms
Source Impedance.....	600 ohm line
Load Impedance.....	600 ohms
Input Level (1% distortion).....	+14 vu, max. bridging
Output Level (1% distortion).....	+14 vu, normal
Distortion....	Less than 1% R.M.S. at rated output for any frequency between 50 and 10,000 cycles
Frequency Response.....	$\pm 0.5$ db. from 40 to 10,000 cycles $\pm 2$ db. from 30 to 15,000 cycles
Noise Level.....	-75 vu
Gain.....	0 db. bridging, 16 db. matching
Tube Complement.....	1 RCA-1620 (or 6J7)
Power Supply.....	Plate, 180-250 volts, 3.8 ma. at 240 V. Filament, 6.3 volts A.C. or D.C., 0.3 amperes
Dimensions.....	12½" deep, 2½" wide, 6" high
Weight .....	4 lbs.

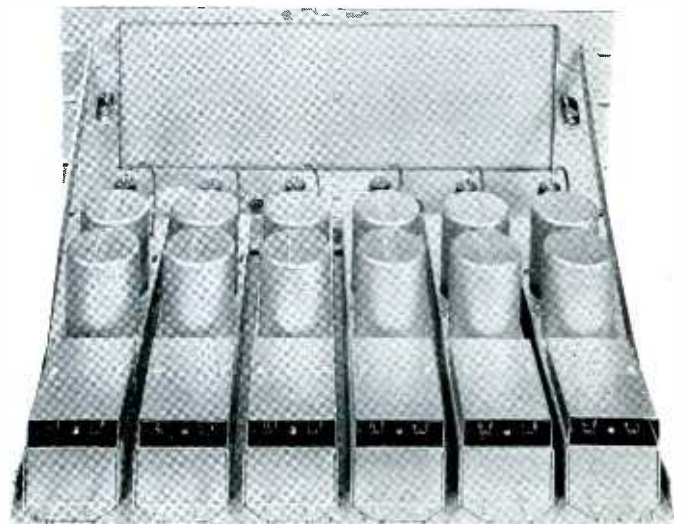
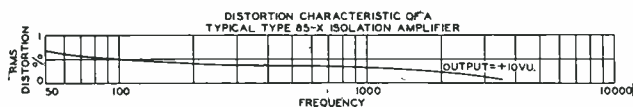
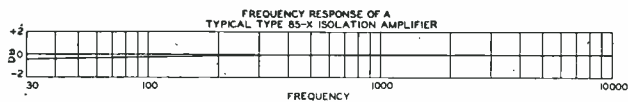

## MI-11302 PRE-AMPLIFIER POWER SUPPLY



THE MI-11302 Power Supply has been designed to furnish plate and filament voltages to a maximum of ten Type 85-B1 Preamplifiers or 85-X Isolation Amplifiers. It will furnish plate voltage to 3 Type 41-C Preamplifiers or 9 Type 41-B Preamplifiers. It contains a hum control potentiometer across the filament supply and an output voltage regulating potentiometer. A power switch and a 1 ampere glass fuse is provided. Two MI-11302 power supplies may be mounted on one 36-A or 36-B Panel.

### SPECIFICATIONS

Output: (a) 3 amperes at 6.4 volts, A.C. (b) 50 ma. at 180 to 250 volts, D.C. Note: Output D.C. voltage may be regulated through above limits by means of integral control. Input: 100 to 130 volts A.C., 50/60 cycles. 65 watts for max. load. 90% P. F. Hum Level: Approx. —133 db. below 250 volts at 50 ma. Tube Complement: One RCA-5Y3G. Dimensions (overall): 8" wide, 12½" deep, 8" high. Net Weight: 18 lbs.

## MI-11606 (Type RT-386) FILAMENT TRANSFORMER



THE MI-11606 (Type RT-386) Filament Transformer furnishes filament voltage to a maximum of six 85-B1 Preamplifiers or 85-X Isolation Amplifiers. It has primary taps for 110 and 120 volts, A. C., 50 or 60 cycles. Its secondary delivers a maximum of 1.8 amperes and 6.3 volts. A variable potentiometer is connected across the secondary and is screw driver operated for obtaining a hum minimum. The overall height is 4" and the overall base dimensions are 2 1/16" x 2 3/8". Four .199" mounting holes are located on 2 5/16" x 1 1/4" center line. Net weight, 2 lbs.

## 15-D METER PANEL

MI-4388



THE 15-D meter is a companion unit of the economy line of speech input equipment.

It consists of a meter and a switch mounted on a standard 3 1/32" speech input panel. It is designed to indicate the operation of the tubes as used in the 87-A Booster amplifier, 86-A Limiter amplifier, 85-B1 pre-amplifier, 84-B studio amplifier, 85-X isolation amplifier and 83-C line amplifier.

The meter is a 7.5 volt d.c. voltmeter having a resistance of 20,000 ohms per volt. The meter terminals are con-

nected to an eleven position two deck switch. The metering terminals provided on the above type amplifiers are to be connected to the switch terminals.

### SPECIFICATIONS

DC Voltmeter.....0—7.5 volts—20,000 ohms per volt  
Switch.....2 decks—11 positions  
Panel Size.....19" x 3 1/32" high  
Standard panel finish in black. Net weight.....4 1/2 lbs.

# BOOSTER AMPLIFIER

## Type 87-A

MI-11215



**T**HE RCA 87-A Amplifier is a two-stage unit for use as a microphone preamplifier or as a booster amplifier in transcription turntables. It is complete with built-in AC power supply which eliminates the need for external rectifiers. It is particularly useful at transmitter installations where a high-gain reamplifier is required between the announce microphone and the limiting amplifier. The 87-A is small in size and two units may be mounted on one 36-A or 36-B Panel.

The 87-A utilizes two RCA 1620 (or 6J7) tubes as triodes with an interstage gain control. One RCA 6X5 tube is employed as the rectifier. The power and audio transformers have been specially shielded and the total hum and noise level does not exceed —69 VU at the maximum gain of 53 db. The unit has a frequency response of  $\pm 1$  db. from 40 to 10,000 cycles and  $\pm 2$  db. from 30 to 15,000 cycles. The total RMS harmonic distortion does not exceed 1% with a —2 VU output when measured at any frequency from 40 to 10,000 cycles.

The gain control is a potentiometer which is continuously variable with logarithmic taper. Connections are provided from each cathode circuit to the terminal board for plate current metering with a high resistance voltmeter such as the 15-D. Both amplifier tubes are mounted in shockproof sockets. The unit is equipped with a power switch and fuse and is provided with a bottom cover plate for shielding in turntable installations.

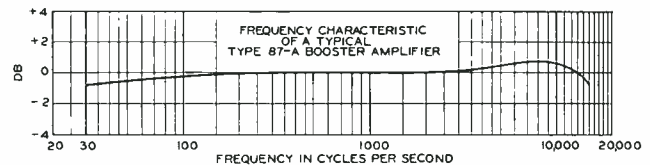

### SPECIFICATIONS

Source Impedance.....	250 or 30 ohms
Input Impedance.....	Unloaded transformer
Maximum Input (1% distortion).....	—26 VU
Load and Output Impedance.....	250 or 500/600 ohms
Power Output.....	—2 VU with less than 1% distortion from 40 to 10,000 cycles.
Transmission Gain.....	53 db. from 250 ohm source to 250 ohm load.
Frequency Response.....	$\pm 1$ db. 40 to 10,000 cycles $\pm 2$ db. 30 to 15,000 cycles
Noise Level.....	—69 VU at maximum gain
Power Input.....	105/125 volts, 50/60 cycles, 15 watts
Tube Complement.....	2 RCA-1620 and 1 RCA-6X5
Dimensions (overall)....	8" wide, 10½" deep and 6½" high
Weight.....	9½ lbs., unpacked

# PROGRAM AND LINE AMPLIFIER

## Type 84-B

MI-11204

THE TYPE 84-B General Purpose Amplifier has been developed to fill the place in the "Economy" line which has long been occupied in the "Standard" line by the famous RCA 40-C. It includes a number of features which make it one of the most versatile speech-input amplifiers on the market. It consists of an AC operated, three stage amplifier featuring high overall gain with a low noise level. This amplifier has been primarily designed as a Studio or Program Amplifier to boost the output of the preamplifiers or mixtures to a level sufficiently high to feed a line or transmitter. For this purpose its characteristics are ideally suited. It may, however, also be used as a high or low gain bridging amplifier for which case a 20,000 ohm bridging input pad has been provided in addition to the regular 250 and 500/600 ohm transformer inputs. For conditions where the normally high gain is not required, as in line and isolation applications, a link switch permits connecting around and removing the first tube leaving a two stage amplifier. Because of the conservatively operated output tubes and a 10.5 ohm load impedance tap, the amplifier may be used as an emergency monitoring amplifier under which condition an output of 1.5 watts may be obtained with approximately 3.5% RMS distortion. However, for normal operation where the output does not exceed +30 VU the RMS distortion is less than 1%.

The circuit of the 84-B Amplifier employs one RCA-1620 pentode connected as the first stage and one RCA-

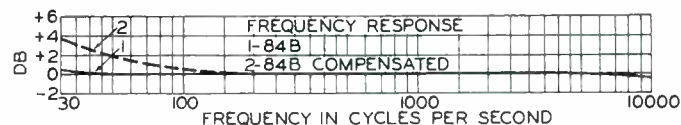

1620 triode connected as the second stage. Two RCA-1621's are used in the power output stage. Resistance coupling is used between the first and second stage and transformer coupling between the second and output stages. As supplied, the 84-B has an essentially flat frequency response from 30 to 10,000 cycles. A compensating network is included as a part of the amplifier which, when used, gives the amplifier a 3 db. rise at 30 cycles. This latter characteristic is desirable when the 84-B is employed in a system using preamplifiers which employ small sized input and output transformers. Such preamplifiers usually have a 30 cycle drop of from 1 to 1.5 db. and since they are single stage units two are usually used in cascade thus requiring a 3 db. compensation in the program amplifier.

The volume control and the hum control are located on the front part of the chassis. Terminals and an external meter switch are provided for checking the cathode voltage (plate current indication) of each tube with an external meter. Also located on the chassis are a line switch and a line fuse. Terminals are provided for supplying an additionally filtered plate voltage (215 volts at 16 ma.) for the preamplifiers. This supply is sufficient for six Type 85-B Preamplifiers. One 84-B Amplifier may be mounted on one 36-A or 36-B Panel.

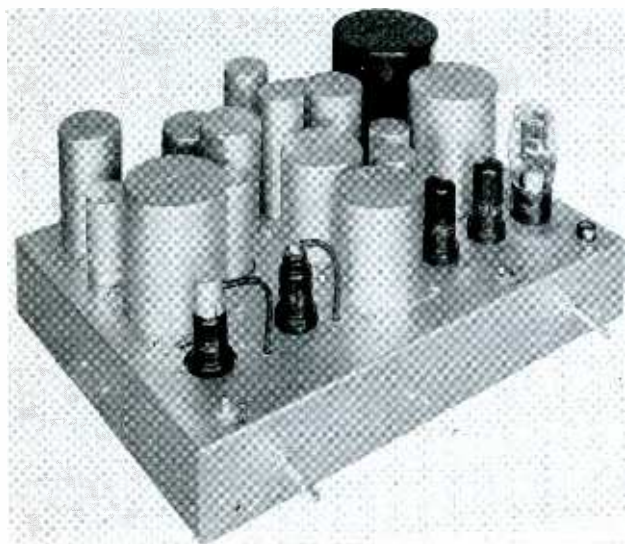

### SPECIFICATIONS

Input Impedances: 500/600 and 250 ohms, balanced; 125 and 62.5 ohms, unbalanced; 20,000 ohms, bridging, balanced. Load Impedances: 500/600 and 250 ohms, balanced and 125, 62.5 or 10.5 ohms unbalanced. Output Level: +24 VU with 0.5% RMS distortion, and +30 VU with 1% RMS distortion for any frequency between 50 and 7500 cycles. Overall Gain: (Max): 79 db., matching; 40 db., bridging; 53 db., matching but less first tube. Max. Input Level: +30 VU limited only by transformer saturation. Frequency Response:  $\pm 1$  db. from 30 to 15,000 cycles. Noise Level: -41 VU unweighted, maximum gain. Power Input: 105 to 125 volts, 50 to 60 cycles, 60 watts at 93% power factor. Tube Complement: 2 RCA-1620, 2 RCA-1621, and 1 RCA-5Y3G. Weight: 40 lbs. (unpacked). Overall Dimensions: 16" wide x 13" deep x 7 $\frac{3}{8}$ " high. Finish: Silver gray opalescent.

# ISOLATION AND LINE AMPLIFIER

## Type 83-C

MI-11206-B



sufficient length to permit it to be controlled from the front of a 36-A or B shelf. The amplifier is provided with power fuses and transformers that have multi-layer cans. This is one of the features which contributes to the extremely low noise level of the amplifier.



**T**HE TYPE 83-C Isolation and Line Amplifier is a two stage self-contained A.C. unit. Its overall gain and impedance characteristics, together with its power output rating permits it to have many uses in a broadcast station. It can particularly be used to advantage as a network or memo pre-amplifier, or as a unit to bridge studio program buses to feed outgoing network lines. It may also be used to isolate a house monitoring circuit from a studio bus where a higher undistorted power output is required than can be obtained from an 85-X amplifier. Two of these amplifiers can be mounted on a 36-A or 36-B shelf, and the design permits tubes to be changed from the front of either of these panels.

The input impedance is 500/600/20,000 ohms and the output impedance is 250/500/600 ohms. These impedances are balanced to ground. The unit is provided with a volume control located on the front of the amplifier chassis. The shaft of this control has

### SPECIFICATIONS

Input Impedances.....	500/600 and 20,000 ohms
Source Impedance.....	600 ohm line
Load Impedance.....	250/500 and 600 ohms
Gain.....	{ Bridging Input: 33 db. Matching Input: 50 db.
Normal Output Level.....	0.5 Watts (+27 VU) with 1% total RMS distortion, 50 to 7500 cycles.
Output Noise Level.....	-60 VU at maximum gain (W.)
Frequency Response.....	±1 db. 30 to 10,000 cycles with matching input. ±2 db. 30 to 15,000 cycles with bridging input.
Power Input.....	105/125 volts, 50/60 cycles, 60 watts
Dimensions.....	8" wide, 12 <sup>3</sup> / <sub>4</sub> " deep, 7 <sup>1</sup> / <sub>2</sub> " high
Weight.....	20 lbs.
Radiotrons.....	1 RCA-1620, 2 RCA-1621, 1 RCA-5Y3G

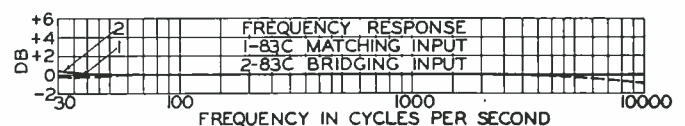



# MONITORING AMPLIFIER

## Type 82-B

MI-11205

**T**HE TYPE 82-B Monitoring Amplifier is a low distortion, AC operated, 8 watt amplifier which may be used with an external volume control. The comparatively high overall gain of the 82-B makes it quite versatile for it may be operated directly from the preamplifiers for audition purposes. Its 500 ohm input and output impedances make it suitable for emergency operation as a program amplifier.

Although its design enables three loudspeakers to be operated very satisfactorily, its low cost permits the broadcast engineer to use individual amplifiers with each of the office and house monitoring loudspeakers. Such a system has proven to be the most satisfactory because it permits dial and direct switching between monitoring channels.

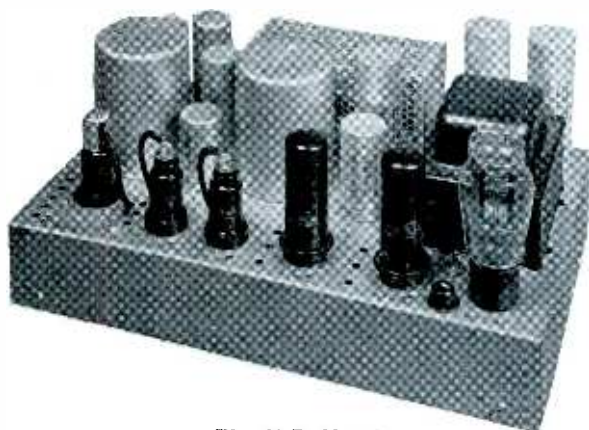

The 82-B Chassis

The inputs of the speaker amplifiers may be bridged across any of the program channels without affecting the volume of other loudspeakers. Such an arrangement allows the monitoring busses to be operated at low levels to prevent cross-talk.

Output impedances of one, two or three loudspeaker voice coils are provided. Field supply (110 volts) for these speakers is furnished by the built-in power supply. When the field excitation is not required the voltage dividing resistor may be disconnected and the power transformer secondary taps changed thus reducing the input power by approximately 40 watts. The volume control is a special unit which may be mounted externally as desired. It consists of a double potentiometer which gives complete control of the volume level and provides a balanced input. Input resistors are so connected that a short in the volume control will not short the line across which it is connected.

The circuit of the 82-B amplifier is straightforward. A triode connected RCA-1620 is employed in the first stage. One is used for the second stage and an additional is used as an inverter tube. Two RCA-1622's in push-pull constitute the power output stage and careful designing has been used to realize the efficiency possible with these beam-power tubes while maintaining complete stability. Degenerative feed-back is utilized and the feed-back loop

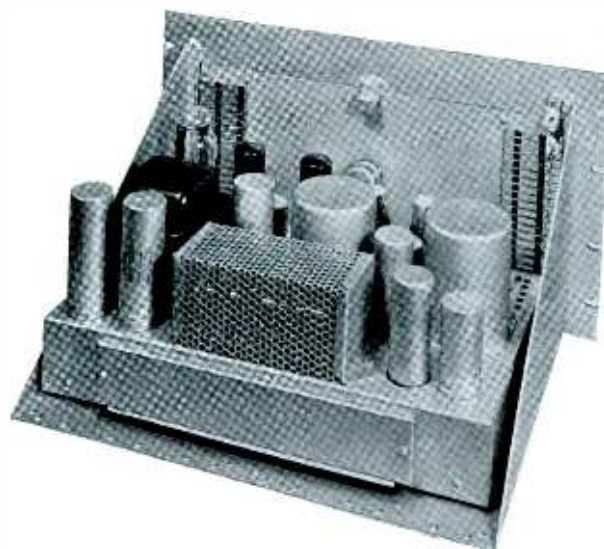

Rear View of 82-B Mounted on 36-A Shelf

is from the secondary of the output transformer to the cathode of the second amplifier tube. By using interstage resistance coupling and by using proper circuit constants, the feed-back has been successfully adapted to operate over a wide band of audio frequencies.

As supplied, the 82-B Monitoring Amplifier has an essentially flat frequency response from 30 to 10,000 cycles. Where it is desirable to peak the high and low frequency ends of the audio band a small compensating network (MI-4313) is available and may be easily installed without drilling. One 82-B amplifier may be mounted on one 36-A or 36-B Panel.

## SPECIFICATIONS

Input Impedances: 500/600 and 20,000 ohms. Output Impedances: 500/600, 15, 7.5 and 5 ohms. Overall Gain: 67 db. with matching input, 49 db. with bridging input and 35 db. with bridging input and remote volume control. Output Level: 8.0 watts with less than 3% RMS distortion at any frequency between 50 and 7500 cycles. Frequency Response:  $\pm 2$  db., 30 to 15,000 cycles. Noise Level:  $-38$  vu, unweighted at full gain. Power Input: 115 volts, 60 cycles, 157.5 watts at 90% power factor. NOTE: When not supplying speaker fields deduct 40 watts. Tube Complement: 3 RCA-1620 (6J7); 2 RCA-1622 (6L6); 1 RCA-5U4G. Weight: 26 lbs. (unpacked). Overall Dimensions: 16 inches x 10 inches x 7 inches high. Finish: Silver gray opalescent. Stock Number Compensating Network: MI-4313A. A 180 V. (21.5 ma.) tap is available on the terminal board that may be used in conjunction with an MI-11203 external filter as an emergency supply for 85-B Preamplifiers.

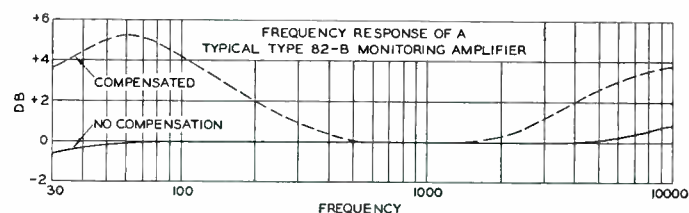

# LIMITING AMPLIFIER

## Type 86-A

MI-11216

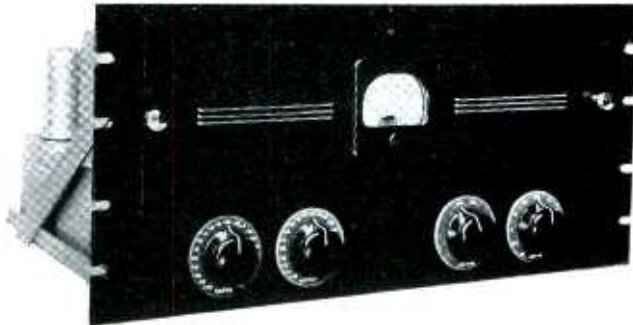

86-A mounted on 36-B Shelf

THE 86-A Limiting Amplifier is a three-stage program-channel amplifier which serves as an automatic audio gain control limiting the output to a pre-determined level. It is particularly useful for use with broadcast transmitters and recording equipments. In each case it permits the average level of the program to be raised several db. without increasing the distortion. It prevents over modulation in transmitters and over cutting in recordings. In both applications it permits a marked improvement in signal to noise ratio.

The 86-A Limiting Amplifier uses push-pull vacuum tubes (RCA 6K7) in the variable-gain stage. The design is such that a uniform frequency response and a remarkably low distortion is maintained with large compression ratios as much as 18 db. Moreover, low distortion is maintained at all modulating frequencies in the normal audio band.

There are no audible "thumps" even though a large compression is suddenly applied. Compression timing constants have been chosen which have proved most desirable in actual broadcast service. The fast pick-up time of one milli-second restricts over modulation surges which might cause transmitter outages. The return time is slow enough to prevent distorting low frequency tones but fast enough to prevent noticeable level reduction after loud volume peaks.

The circuit of the 86-A is straight forward and basically similar to the widely used RCA 96-AX DeLuxe Limiting Amplifier. Push-pull stages are used throughout. The AC power supply is self contained and utilizes one RCA-5T4 rectifier tube. The hum and noise level is maintained better than 60 db. below the signal through special transformer shielding. Sufficient maximum gain (60 db.) has been provided to permit fully modulating the transmitter from a two-stage pre-amplifier, for local announcements. The push-pull output stage and the correct circuit design provide a maximum power output of 1 watt (+30 VU)

with less than 0.5% total R.M.S. distortion at 400 cycles and with a compression of 18 db. The distortion is less than 2% R.M.S. when measured at any frequency between 50 and 7000 cycles.

All the components are mounted on a single metal chassis. A meter is provided for (1) indicating gain reduction directly in db., (2) dynamic match indicator for input tubes, (3) measurement of all tube plate currents, and (4) measurement of plate voltage. A switch on the front of the chassis selects the desired meter function. Step-by-step input and output volume controls are provided.

The controls are equipped with "VU" scales to indicate input and output levels at the verge of compression. Auxiliary adjustable controls are (1) hum balance, (2) zero adjustment of gain reduction meter scale, (3) adjustment of 2 db. in level at which limiting action takes place, and (4) switch (on front) which makes limiter function inoperative. A power switch and fuse are provided. For rack mounting the Type 36-B Shelf should be used. A special 36-B door panel with meter cut-out is supplied with the 86-A Amplifier.

### SPECIFICATIONS

Input Impedance: 250 or 500/600 ohms. Output Load Impedance: 250 or 500/600 ohms. Max. Input Level: +10 VU at verge of compression. +30 VU with 18 db. gain reduction. Min. Input Level: -30 VU at verge of compression. Max. Output Level: +30 VU with less than 2% R.M.S. distortion at any frequency between 50 and 7000 cycles. Gain: 60 db. maximum with no compression. Frequency Response:  $\pm 1$  db. 30 to 10,000 cycles, and  $\pm 2$  db. 30 to 15,000 cycles, at any setting of gain controls and with or without compression. Noise Level: -58 VU at max. setting of output control. -70 VU at min. setting of output control. Compression Characteristics: Gain reduction—0.001 second. Gain recovery—90% in 2 seconds. Tube Complement: 2 RCA-6K7, 1 RCA-6N7, 2 RCA-1621, 1 RCA-6R7, 1 RCA-5T4. Power Input: 105/125 volts, 50/60 cycles, 70 watts. Dimensions: 16" wide, 13" deep, 7 $\frac{3}{8}$ " high. Weight: 40 lbs. unpacked (less 36-B panel).



86-A mounted on 36-B Shelf  
(Door opened)

# PANEL AND SHELF

MI-4681C Black  
MI-4681E Transmitter Gray  
MI-4681G Umber Gray

MI-4682 Black  
MI-4682A Transmitter Gray  
MI-4682B Umber Gray

## Type 36-A

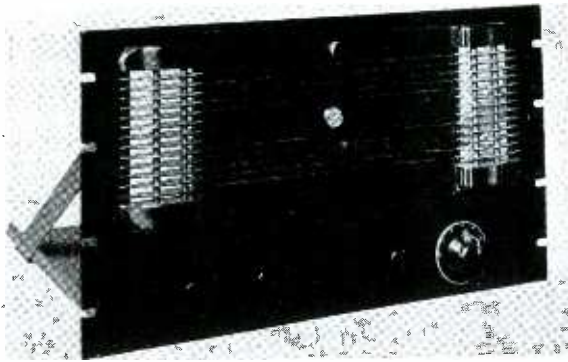

**T**HE TYPE 36-A Panel and Shelf Assembly is designed to mount the various units of the "Economy" line on a standard speech input rack. It can of course be used for rack mounting various other equipment which has suitable dimensions. The 36-A matches the front panel appearance and provides some of the features of the "De Luxe" line of RCA Speech Input Equipment. Ventilation is obtained through the chromium plated louvers which are a part of the door. On the rear of the panel is secured a horizontal shelf on which the amplifier chassis is normally mounted. Such a mounting arrangement allows quick access to tubes and comparatively easy chassis removal for servicing. It also maintains a vertical mounting for all the tubes thereby insuring quieter operation and longer life.

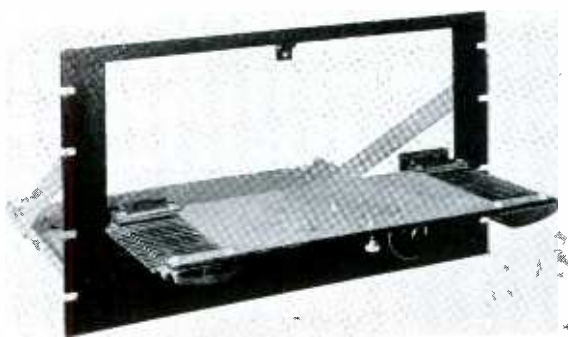

### SPECIFICATIONS

Panel Dimensions: 19" wide x 10½" high. Shelf Dimensions: 16⅝" wide x 13" deep. Provides mounting space for:

- 6—85-B1 Preamplifiers
- 6—85-X Isolation Amplifiers
- 1—84-B Program Amplifier
- 1—82-B Monitoring Amplifier
- 2—83-C Line Amplifiers
- 2—87-A Booster Amplifiers
- 2—MI-11302 Power Supplier

## Type 36-B

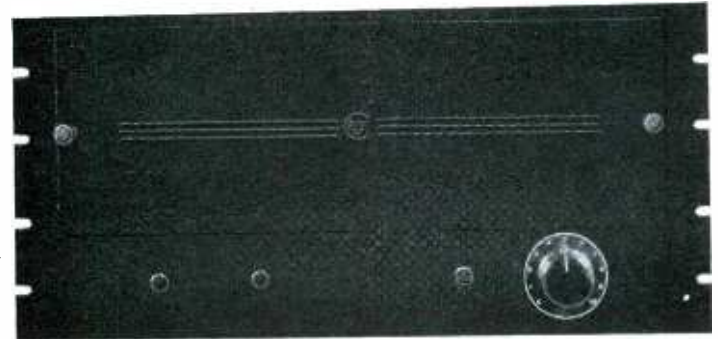

**T**HE TYPE 36-B Panel and Shelf Assembly is similar to the 36-A except that the door is not hinged and the louvers have been omitted. Thus the 36-B provides a high quality low cost rack mounting for "Economy" line amplifier units. The mounting presents a very neat appearance and offers nearly all the features described for the 36-A. The door of the 36-B has three stripes on each side of the nameplate and holes are provided at the lower right and lower left for volume controls and meter switches. A metering switch is supplied with each shelf and is used for switching a meter for measuring bias voltages of the 83-C, 84-B and 85-B1 amplifiers, thus providing an indication of plate current.



### SPECIFICATIONS

Panel Dimensions: 19" wide x 8¾" high. Shelf Dimensions: 16¾" wide x 13" deep. Provides mounting space for:

- 6—85-B1 Preamplifiers
- 6—85-X Isolation Amplifiers
- 1—84-B Program Amplifier
- 1—82-B Monitoring Amplifier
- 2—83-C Line Amplifiers
- 1—86-A—Limiting Amplifier
- 2—87-A Booster Amplifiers
- 2—MI-11302 Power Supplier

# SUMMARY OF RCA BROADCAST AMPLIFIER CHARACTERISTICS

Type	Usage (Equipment Line)	Max. Gain	Max.* Input	Max.* Output	Input Impedance	Output Impedance	Type Mounting	Cat. Page
85-B1	Preamplifier, 1 stage (Economy)	30 db.	-30 VU	0 VU	30/250 ohms	60/500/250	Chassis (or rack)	27
41-B	Preamplifier, 2 stages (Standard)	48 db	-48 VU	0 VU	50, 250 ohms	250, 500 ohms	Rack	24
41-C	Triple Preamplifier, each 2 stages (DeLuxe)	46 db	-48 VU	0 VU	50, 250 ohms	250, 500/600 ohms	Rack	20
84-B	Program and Line Amplifier (Economy)	79 db matching 40 db bridging	+30 VU	+30 VU	500/600, 250, 125 62.5, 20,000 ohms	500/600, 250, 125 62.5, 10.5 ohms	Chassis (or rack)	31
40-C	Program Amplifier with V. I. (Standard)	69 db	-5 VU	+26 VU	62.5, 125, 250, 500 ohms	250 ohms 500 ohms	Rack	25
40-D	Program Amplifier with V. I. (DeLuxe)	75 db	-37 VU	+26 VU	62.5, 125, 250, 500/600 ohms	250, 500/600 ohms	Rack	21
85-X	Isolation Amplifier (Economy)	0 bridging 16 db matching	+18 VU +3 VU	+18 VU	20,000 ohms 600 ohms	600 ohms	Chassis (or rack)	28
55-B	Isolation and Line Amplifier (DeLuxe)	30 db bridging 47 db matching	+27 VU +18 VU	+27 VU	500, 20,000 ohms	500, 250, 125, 62.5, 10.5 ohms	Rack	22
82-B	Monitor Amplifier (Economy)	67 db matching 49 db bridging 35 db bridging with remote v.c.	+30 VU	8 Watts (with 2% RMS dist. 50-10,000 cycles)	500/600 ohms 20,000 ohms	500/600, 15, 7.5, 5 ohms	Chassis (or rack)	33
94-D	Monitor Amplifier (DeLuxe)	77 db matching 45 db bridging 39 db bridging with remote v.c.	-35 VU, matching -19 VU, bridging +30 VU, brdging with remote v.c.	17 Watts (with 3% RMS dist. 100-10,000 cycles)	500/600, 20,000 ohms	500/600, 15, 7.5, 5 ohms	Rack	23
83-C	Line Amplifier (Economy)	33 db Bridging 50 db Matching	+27 VU +18 VU	+27 VU	500/600/20,000	250/500/600	Chassis (or rack)	32

0 VU = 1 milliwatt across 600 ohms = -11 db. with 12½ milliwatt reference.

\* Unless otherwise specified Max. Input and Output levels are for 1% RMS distortion when measured at any fundamental frequency between 50 and 7,500 cycles.

# CABINET RACK

## Type 9-AX

### SIZE AND ACCESSORIES

### SPECIFICATIONS

Type 9-AJX Cabinet Rack (82 $\frac{7}{8}$ " high) with 2" "J" Strips. Stock MI-4519/4537

Type 9-AUX Cabinet Rack (82 $\frac{7}{8}$ " high) with 1 "U" Strip. Stock MI-4519/4524

Type 9-AJZ Cabinet Rack with 4 brushed chromium "J" strips and trim ("J" strips and trim not attached). Stock MI-4519/4656

Type 9-AUZ Cabinet Rack with brushed chromium "U" strips and trim ("U" strip and trim not attached). Stock MI-4519/4658

These racks may be obtained in black, transmitter gray and umber gray finish.

Net weight, 190 lbs.

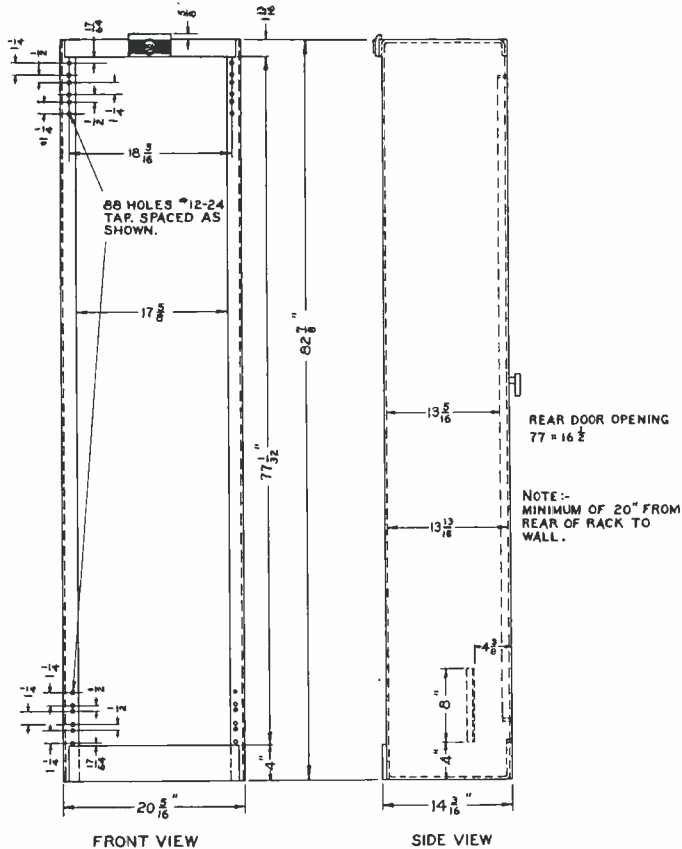

FRONT VIEW

SIDE VIEW

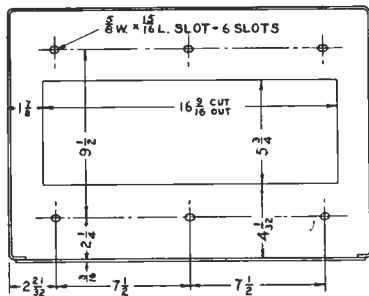

VIEW OF BASE SHOWING MOUNTING HOLES

OUTLINE DIMENSIONS OF 9AX CABINET RACK

### ACCESSORIES

Stock MI-4656 brushed chromium "J" trim for 9AX Rack (4 "J" strips and trim)

Stock MI-4658 brushed chromium "U" trim for 9AX Rack (1 "U" strip and trim)

Stock MI-4524 "U" Strips for 9AX Cabinet Racks

Stock MI-4537 "J" Strips for 9AX Cabinet Racks

## BLANK PANELS

### STANDARD PANELS IN ALL WIDTHS

IN order to provide for filling spaces on the rack not occupied by equipment panels, a complete line of blank panels is carried in stock. These include all standard widths from 1 $\frac{3}{4}$ " to 12 $\frac{1}{4}$ ". They are of  $\frac{3}{16}$ " sheet steel and are finished so that they exactly match the standard equipment panels.

- Type MI-4590 Blank Panel (1 $\frac{2}{3}$ " x 19")
- Type MI-4598 Blank Panel (2 $\frac{1}{8}$ " x 19")
- Type MI-4599 Blank Panel (2 $\frac{3}{8}$ " x 19")
- Type MI-4589 Blank Panel (3 $\frac{1}{2}$ " x 19")
- Type MI-4591 Blank Panel (3 $\frac{5}{8}$ " x 19")
- Type MI-4592 Blank Panel (5 $\frac{1}{2}$ " x 19")
- Type MI-4593 Blank Panel (6 $\frac{1}{2}$ " x 19")
- Type MI-4594 Blank Panel (8 $\frac{3}{8}$ " x 19")
- Type MI-4595 Blank Panel (10 $\frac{1}{2}$ " x 19")
- Type MI-4596 Blank Panel (12 $\frac{1}{2}$ " x 19")

These blank panels may be obtained in black, umber gray or transmitter gray finishes.

**T**HE Type 9-AX Cabinet Rack is now more generally used than any other type of speech input rack. It provides complete shielding and protection for all of the equipment on the racks, while at the same time largely dispensing with individual shield covers. A large easily-opening rear door provides instant access to all equipment. The rack is drilled for standard 19" panels exactly as are regular racks. A total of 77" of panel space is provided. If desired, cabinet racks, with chromium strips and trim can be supplied. Regular "U" and "J" strips, both for the standard and cabinet racks, are also carried in stock.

# WALL MOUNTING CABINET

MI-11500

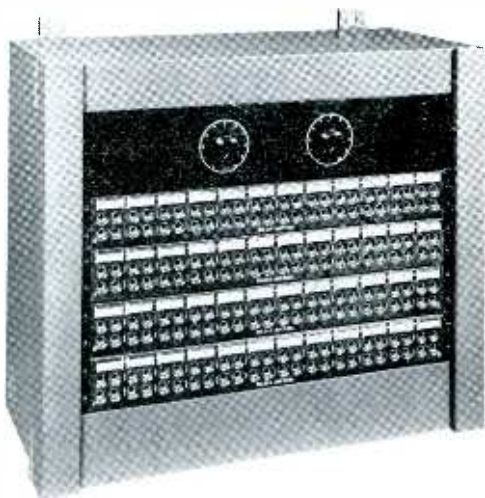

**T**HE MI-11500 Cabinet has been designed especially to mount a combination of line equalizers (Type 56-B, 56-D or 56-E) and jack panels (Type 33-A or 33-B). It will be found particularly useful for terminating remote lines in installations using the 76-B2 Consolette.

The cabinet is constructed of steel and is equipped with a hinged door on which the panels may be mounted. Standard drilling has been provided for standard 19" panels which are attached by means of the machine screws supplied. A left-hand and a right-hand "J" strip are furnished to cover the

mounting screws. Five knockouts are provided in the bottom of the cabinet, and five in the top, for conduit connections. Five terminal blocks may be mounted inside the cabinet on the brackets provided. Mats are available for improving the appearance of the jack strips. (See page 43.)

## SPECIFICATIONS

Dimensions Overall.....21" wide, 19 $\frac{1}{4}$ " high, 10 $\frac{3}{8}$ " deep  
 Weight (less panels).....36 lbs. unpacked  
 Finish .....Dark Umber-Grey  
 Panel Mounting Space.....19" wide, 12 $\frac{1}{4}$ " high  
 Terminal Mounting Space....Maximum—Four Standard 80 terminal (4 rows of 20 each) blocks which are 2 $\frac{15}{16}$ " wide by 6 $\frac{1}{16}$ " long.

## SAMPLE COMBINATIONS

1. 1—56E Equalizer and 4—33A Jack Strips.
2. 1—56E Equalizer, 3—33A Jack Strips; 1 MI-4590 (1 $\frac{3}{4}$ " blank panel and 1 MI-11503 (7") Jack Mat.
3. 1—56E Equalizer, 2—33A Jack Strips, 1 MI-4591 (3 $\frac{1}{2}$ " blank panel and 1 MI-11502 (5 $\frac{1}{4}$ " Jack Mat.
4. 1—56E Equalizer, 1—33A Jack Strips, 2 MI-4598 (2 $\frac{1}{8}$ " blank panels and 1 MI-4599 (2 $\frac{3}{8}$ " blank panel.
5. 1—56E Equalizer, 1—33A Jack Strip, 1 MI-11501 (3 $\frac{1}{2}$ " Jack Mat and 1 MI-4592 (5 $\frac{1}{4}$ " blank panel.
6. 2—56E Equalizers, 2—33A Jack Strips and 1 MI-11502 (5 $\frac{1}{4}$ " Jack Mat.
7. 1—56D Equalizer, 1—33A Jack Strip and 1 MI-11501 (3 $\frac{1}{2}$ " Jack Mat.
8. 1—56B Equalizer, 3—33A Jack Strips and 1 MI-11503 (7") Jack Mat.

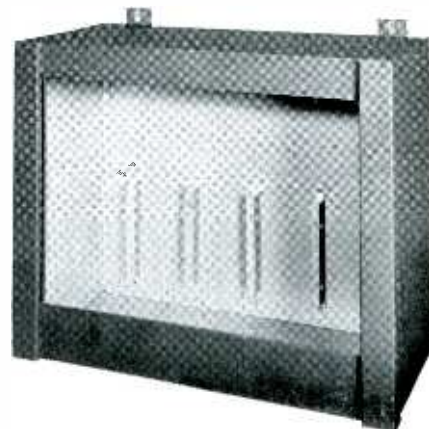
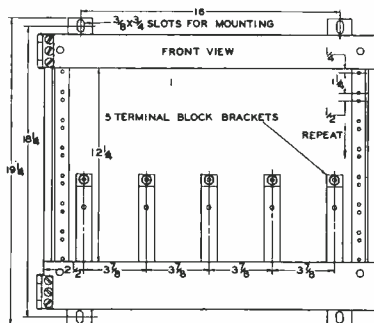
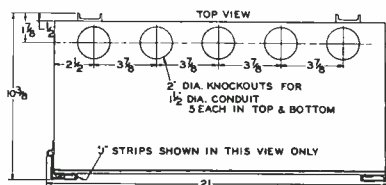

## SWITCH and FUSE PANEL

### Type 57-C

MI-4395A

*Especially Designed for Use with  
A. C. Operated Equipment*



THE TYPE 57-C Switch and Fuse Panel is an auxiliary unit designed for input control of the AC supply. Ordinarily one such panel is used with each rack or channel of speech units. On this panel are mounted and wired an indicator lamp with red cap, two single fuseblock of the screw-plug type and a double-pole single-throw power switch. In addition there is a subpanel which is drilled to provide a mounting for six of the standard filament transformers (two isolation and two filament, or one isolation and four filament) used with the various amplifier units. This panel, ordinarily located near the bottom of the rack, thus insures a convenient mounting for these transformers and keeps them well away from the low-level amplifier circuits. A removable door permits front of panel access to fuses and pilot lamp.



#### SPECIFICATIONS

General Type: 110 volt, A.C. control. Switch: double-pole, single-throw. Indicator Lamp: 110 volt. No. of Transformer Mountings: six. Fuses: Two screw-plug type. Dimensions:  $5\frac{7}{32}$ " x 19". Weight:  $8\frac{1}{2}$  lbs., unpacked.

## PATCH CORDS

RCA maintains a stock of patch cords for the convenience of broadcasting stations. These cords are the standard telephone type using two W. E. 241-A Double Plugs and a W. E. cord. Three sizes are available as listed below.

- MI-4652-2A Two foot cord length
- 4652-4A Four foot cord length
- 4652-6 Six foot cord length

## JACK PANELS

### Type 33-A and Type 33-B

MI-4645

MI-4646

*Standard Panels for Use with All Equipments*

OF THE auxiliary panels designed for use with the basic speech units described on the previous pages, the jack panels are perhaps the most important. By bringing out the input and output connections of the amplifier and mixing units to jacks, the overall flexibility of a speech



33-A Jack Panel



A Rear View of the 33-A Jack Panel



33-B Jack Panel

input system is greatly increased, and testing and servicing facilitated. Type 33-A and 33-B Jack Panels are most convenient for this use. The former consists of one row of twelve double-jacks with designation-card holders—while the latter is similar but has two rows of jacks. The jacks are of the closed-circuit type, so that regular circuits are ordinarily normaled through—and are broken only when a double plug is inserted in order to make an external connection. The jack sleeves are chromium plated.

#### SPECIFICATIONS

Number of Jacks: 48 in 33-A, 24 in 33-B. Type of Jacks: Double jacks of standard closed-circuit type. Dimensions: of 33-A,  $2\frac{1}{8}$ " x 19"; of 33-B,  $1\frac{1}{4}$ " x 19". Net Weight: 33-A,  $5\frac{1}{2}$  lbs.; 33-B, 3 lbs.

## JACK MATS

JACK MATS are available for covering 1, 2 or 3 Type 33-A Double Jack Strips. When ordering specify finish required.

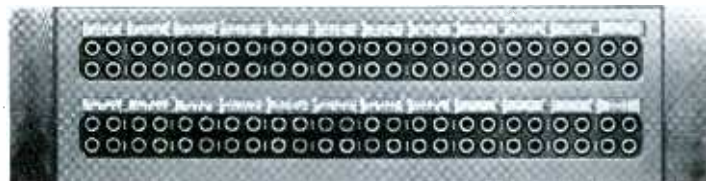

33-A Jack Panels mounted in 78-B1 Rack

#### SPECIFICATIONS

- MI-11501 Single Jack Strip Mat. Overall Size  $19$ " x  $3\frac{15}{32}$ "
- MI-11502A Double Jack Strip Mat. Overall Size  $19$ " x  $5\frac{7}{32}$ "
- MI-11503 Triple Jack Strip Mat. Overall Size  $19$ " x  $6\frac{31}{32}$ "

# RELAY AND SIGNAL LAMP POWER SUPPLY

MI-4308-A, Black Finish

MI-4308-C, Umber Finish

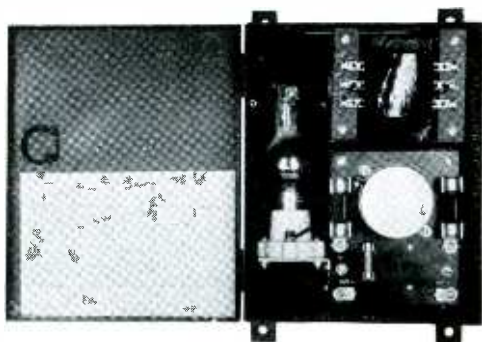

## SPECIFICATIONS

Input.....110/120 volts, 50/60 cycles AC.  
 Output.....12 volts, 1 ampere, DC.  
 Size.....10 $\frac{1}{4}$ " high, 8 $\frac{3}{8}$ " wide and 4 $\frac{5}{8}$ " deep  
 Weight.....18 lbs., unpacked

THE MI-4308 Relay Power Supply is a small single tube rectifier which has been designed to furnish a DC output of 12 volts at 1 ampere from an AC input source of 110/120 volts, 50/60 cycles. It is particularly suited for operating relays and indicator lamps. One Rectigon tube (RCA No. 20801) is used in a half-wave rectifying circuit. Sufficient filtering is provided to prevent hum cross talk to the audio circuits.

The unit is enclosed in a ventilated steel wall box. Two  $\frac{1}{2}$ " conduit knockout holes are provided in the bottom. Mounting strips on the rear provide four  $\frac{5}{16}$ " diameter holes on 11 $\frac{1}{2}$ " x 7" center lines.



# SPEECH INPUT INTERCONNECTING CABLE

THE majority of wires required to interconnect the various components of a speech input assembly are of a special type and cannot be readily purchased from the local electrical dealer. In order to avoid unnecessary installation delays, the RCA Manufacturing Company carries in stock three of the generally used special type wires.

## MI-63A—CABLE (Solid Conductor)

This is a twisted pair No. 19 AWG, solid, tinned copper conductor insulated with varnished cambric and a serving of cotton. Color Code—Red and black, outer shield is tinned copper braid. Rating—600 volts. Stocked in 1000' rolls.

## MI-64—CABLE (Stranded Conductor)

Shielded, twisted pair, each conductor consisting of 10-

.010 tinned copper conductors (equivalent to No. 19 AWG). Insulation is varnished cambric over which is a serving of cotton. Color Coding—Red and black, outer shield is tinned copper. This cable is recommended for power circuits and for use in hinged circuits. Rating—600 volts. Stocked in 1000' rolls.

## MI-65—CABLE (Stranded Conductor)

The cable has the same insulation and shielding as the MI-64 but the conductors are composed of 26-.010 conductors (equivalent to No. 16 AWG). Color Coding—Red and black and outer shield is tinned copper. This cable is recommended for power wiring, especially the 110 volts supply and filament circuits. Rating—600 volts. Stocked in 1000' rolls.



# TERMINAL TRANSFORMERS

RCA offers several transformers for interconnection between speech input units which will be useful to the broadcasting station. These transformers are used in RCA amplifiers and are of the highest quality design and manufacture. The several transformers are provided with electrostatic shields between primary and secondary and are

## MI-4900-A LINE TRANSFORMER

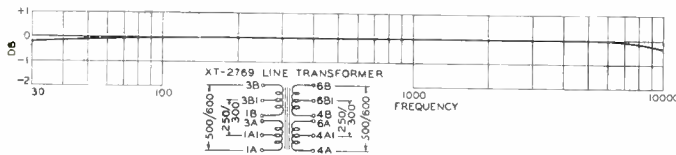

THE core structure, frequency characteristics and shielding of this transformer makes it an ideal unit for isolating line circuits. The frequency response is  $\pm 1\frac{1}{2}$  db., 30 to 10,000 cycles and  $\pm 1$  db. to 15,000 cycles. Its large number of taps provide several combinations of available impedances. One or two of these transformers are very useful items to have around any broadcast station. The impedance combinations are 125/250/300/500/600 ohms to 125/250/300/500/600 ohms.

## MI-4901 BRIDGING TRANSFORMER

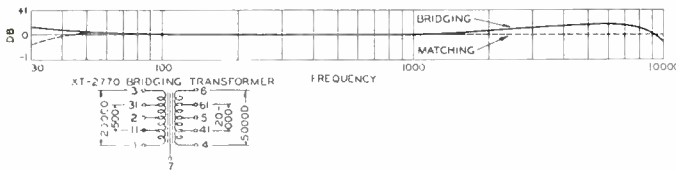

THE MI-4901 transformer has an impedance ratio of 500/20,000 ohms to 500/50,000 ohms. It may be used as an input transformer for a bridging line amplifier or a monitoring amplifier. It may also be satisfactorily used where it is desired to bridge a program line to feed programs to other mixing or outgoing circuits such as normally employed in a master control room line distribution system. The frequency response is  $\pm 1\frac{1}{2}$  db. from 30 to 10,000 cycles and  $\pm 1$  db. to 15,000 cycles.

## MI-4902 MIXING TRANSFORMER

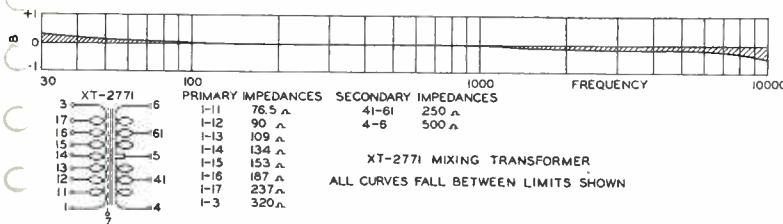

THOSE contemplating the design of their own, or special microphone mixing circuits, will find this transformer usable for a large number of mixer combinations. The frequency response is  $\pm 1\frac{1}{2}$  db. from 30 to 10,000 cycles and  $\pm 1$  db. to 15,000 cycles. The secondary will feed either 250 or 500/600 ohms.

furnished with heavily shielded cases. Cores are of special high permeability steel. Terminals are at the top and diagrams of the connections are stenciled on the side of the case. Broadcasting stations may employ the RCA terminal transformers between units with assurance that the overall fidelity of the system will be maintained.

Dimensions of all cases —  $3\frac{1}{2}$ " dia.,  $4\frac{3}{8}$ " height overall. Baseplate  $3\frac{3}{4}$ " x  $3\frac{3}{4}$ ". Mounting hole center lines are 2.137" x 2.137".



## MI-4903 INPUT TRANSFORMER

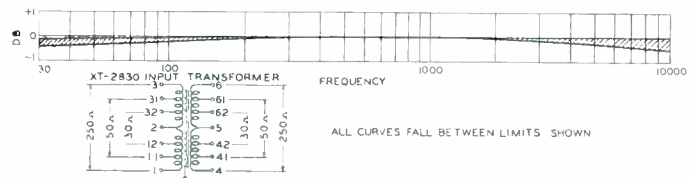

THE MI-4903 Input Transformer has been designed especially for use in low level circuits and its main purpose is to match pickups, microphones, etc. to amplifier inputs or other circuits. Its impedance ratio is 30/50/250 ohms to 30/50/250 ohms. The frequency response is  $\pm 1\frac{1}{2}$  db. from 30 to 10,000 cycles and  $\pm 1$  db. to 15,000 cycles.

## MI-4904 LOUDSPEAKER TRANSFORMER

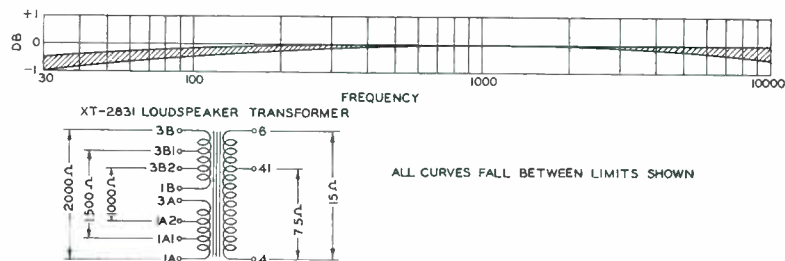

THIS Transformer has been designed to match the impedance of one or two loudspeakers to a 500 ohm circuit. The 1000/1500/2000 ohms primary makes it possible to place two, three or four of these transformers across a 500 ohm circuit to feed individual speakers. This transformer is rated at 8 watts with a frequency response of  $\pm 1$  db. from 30 to 15,000 cycles.

Type 56-D  
MI-4169

LINE EQUALIZERS

Type 56-B  
MI-4167-A



THE Type 56-D Variable Equalizer provides a desirable means of equalizing high or low grade lines because it provides a maximum of boost of 26 db. at 25, 50 or 100 cycles simultaneously with a maximum boost of 26 db. at 4,000, 6,000, 8,000 or 10,000 cycles. The equalization is variable in steps of 3 db. by means of "bridged-T" pads. The high frequency and low frequency equalizing controls are made independent of each other through the use of a constant impedance circuit. A master variable attenuator permits an overall volume control in 19 steps on 3 db. The panel includes a balanced line transformer with static shielding between windings and with a highly efficient outside shielding to eliminate hum pickup. A dust cover is included.

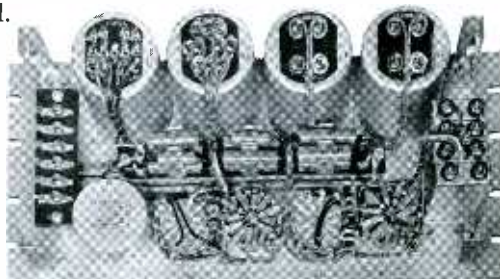

SPECIFICATIONS

Input Impedance: 600 ohms, balanced. Output Impedance: 600 ohms, unbalanced. Input Level: +11 VU. Output Level: +11 VU. Insertion Loss: 0.6 db. Maximum Loss: 27 db. low frequency equalization; 27 db. high frequency equalization; 54 db. low and high frequency equalization. Noise Level: -100 VU. Panel Height: 8 3/4". Weight: 24 lbs., net.

Type 56-E  
MI-4162



THE RCA Type 56-E Line Equalizer has been designed to equalize the non linear characteristics of either one or two telephone lines, and it consists of two separate and complete variable equalizers mounted on a single panel. Any amount of equalization from zero to 40 db. may be obtained in steps of approximately 3 db. The 56-E does not include line transformers or master attenuators.

SPECIFICATIONS

Source Impedance: 500/600 ohms. Insertion Loss: 7 db. minimum. Mounting: May be rack mounted on any standard rack or on an MI-11500 wall-mounting cabinet. Size: 19" wide, 4 3/4" deep, 3 1/2" high. Weight: 7 lbs., unpacked. Frequency: 10,000 cycles.



ONE of the four line equalizing units for use with RCA transmitter installations, the RCA 56-B is a rack mounting panel equipped with a variable ladder type pad in the output for controlling gain and with the network resistors variable from the panel. A repeat coil is included. This unit is desirable where equalization is likely to be varied or where one equalizer is not tied up permanently with a line.

SPECIFICATIONS

56-B—Input and Output Impedance: 500 ohms. Attenuation: 20 to 50 db. Volume Control Range: 38 db. in 2 db. steps. Resistors: 100 ohms in 10 ohm steps and 10 ohms in 1 ohm steps. Repeat Coil: 1-1 ratio. Dimensions: 19" length, 5 1/4" height, 8 1/2" depth. Weight: 20 lbs. unpacked. Frequency: 10,000 cycles.

Type 56-C  
MI-4168



THE 56-C equalizer is a semi-fixed unit, mounted in a metal case to reduce the space requirements so that a number may be located on the rear of one blank panel. Similar in appearance to a transformer, the resistance terminals are brought out to soldering lugs on the top of the case, where they may be shorted out until the correct equalization is obtained. The 56-C is particularly useful in connection with permanent lines.

SPECIFICATIONS

56-C—Input and Output Impedance: 500 ohms, approx. Attenuation: 1 to 30 db. Resistors: Tapped, semi-fixed, 1-111 ohms. No repeat coil. Dimensions: 3 7/8" length, 3 3/4" height, 2 1/2" depth. Weight: 2 lbs. unpacked. Frequency: 10,000 cycles.

# VARIABLE SOUND EFFECTS FILTER

MI-4917



THE MI-4917 is a combination of variable high and low pass filters, and is a very useful item around any broadcast studio where special sound effects are required, especially in the reproduction of dramatic plays, etc. The filters and two switches are mounted on a standard speech input panel. The two nine position switches are calibrated for high and low cut-off frequencies of 100, 250, 500, 1000, 2000, 3000, 4000, and 5000 cycles. There is also an "off" position on each switch. A key switch is provided for re-

moving the filter from the circuit, thus making it possible to preset the filter combination desired and insert it in the circuit when required.

## SPECIFICATIONS

Input Impedance: 600 ohms. Output Impedance: 600 ohms. Frequency Response: Attenuation approximately 4 db. at indicated cut-off frequency and approximately 19 db. one octave further from indicated cut-off frequency. Insertion Loss: 1 db. or less at frequencies remote from cut-off. Dimensions: 5 $\frac{1}{4}$ " high x 19" long x 5" deep. Weight: 15 lbs. (unpacked).

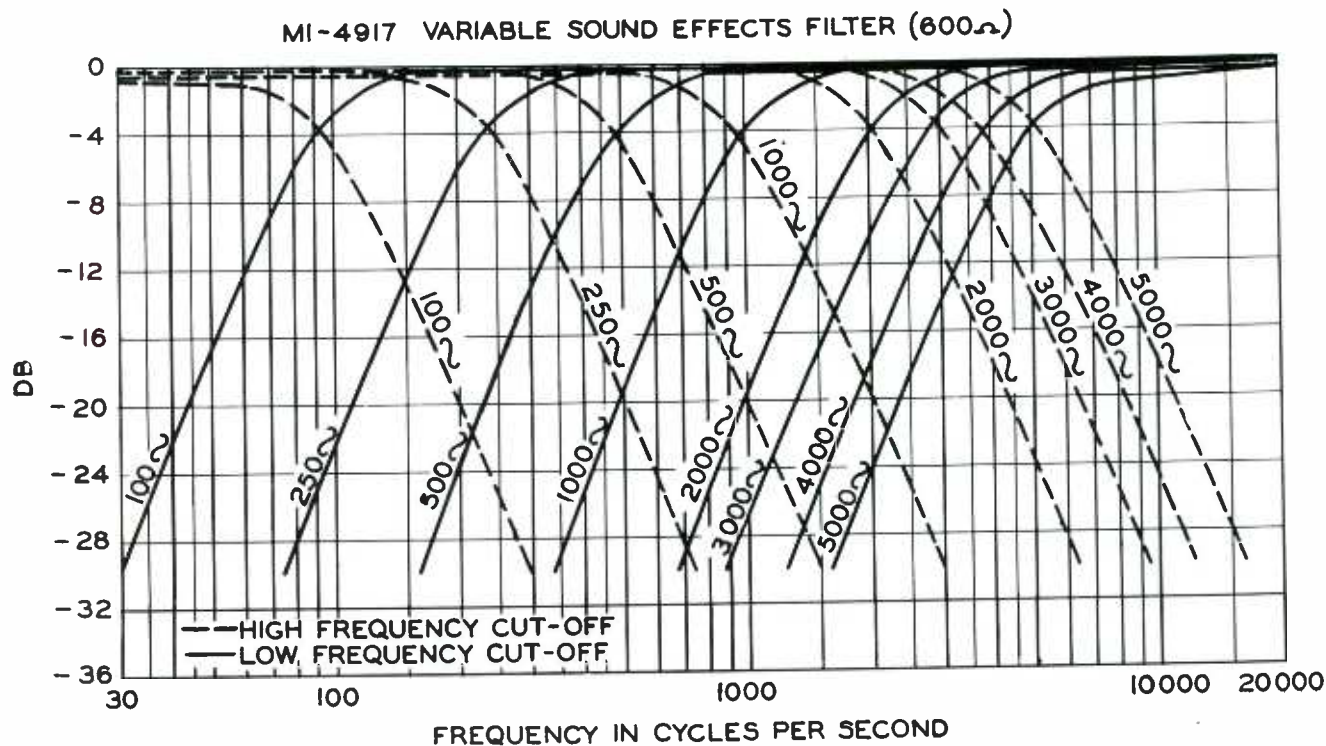

# TRANSCRIPTION TURNTABLE

## Type 70-C

MI-4871 BLACK

MI-4871A UMBER-GREY



**T**HE RCA 70-C Turntable is designed to provide the best possible record reproduction. It features accurate speed, quiet operation, high-fidelity response and an attractive appearance. Realizing the importance of a transcription turntable in the broadcasting station, RCA has designed the 70-C for long life trouble-free performance. The 70-C is similar to the popular 70-A and 70-B equipments over 1,000 of which have been used with satisfaction by hundreds of broadcasting stations.

The 70-C is equipped with the newly developed high fidelity lateral tonearm employing a permanent diamond point stylus and is provided with a number of mechanical improvements. With the new lateral tonearm, a quality of reproduction is attained which results in an amazing improvement, especially with lateral transcriptions recorded with characteristics which permit full range reproduction. The frequency response of the pickup extends from 30 cycles to over 10,000 cycles and the harmonic distortion is unusually low. For playing records having a higher surface noise a variable high frequency cutoff filter is incorporated. This allows the range to be reduced to 6,000 or 4,500 cycles if desired.

The Type 70-C Transcription equipment is designed to operate at both 78 R.P.M. and 33 $\frac{1}{3}$  R.P.M.—the speed

changeover being accomplished in one revolution of the turntable. Moreover, by adding the Type 71-C Vertical Tonearm, provision is made for reproduction of both vertical-cut and lateral-cut recordings. A Type 72-C Recording Attachment is available for use with the 70-C to produce high-quality instantaneous recordings inexpensively and conveniently. Finally, a large-size turntable is employed so that any size records up to 18" can be accommodated. As a result, this equipment is completely universal; that is, it may be used interchangeably to reproduce vertical-cut transcriptions, lateral-cut transcriptions, and for making recordings, both at 33 $\frac{1}{3}$  and 78 R.P.M.

The complete equipment is housed in an attractive console finished in tones of umber grey or black. The high-torque synchronous motor is cushion-mounted on the bottom shelf of the console and is flexibly coupled to the main turntable-spindle. The later is cushion-mounted in the top of the console. A fly-wheel, mounted on the main-spindle, together with a mechanical filter in the drive shaft, insure excellent speed regulation within four-tenths of one per cent at 78 R.P.M. and within six-tenths of one per cent at 33 $\frac{1}{3}$  R.P.M. The cushion-mounting of the motor and spindle housing, and cushioning of the suspension arms, adequately prevent noise and vibration pickup. Speed reduction is accomplished by means of a heavy duty ball-bearing speed-reduction mechanism operated by a speed-shift button conveniently located on rim of the turntable disc.

## SPECIFICATIONS

Pickup: Lateral (mounting cutouts provided for adding 71-C Vertical Pickup and 72-C Recorder). Frequency Response: 30 to 10,000 cycles. Output Level: -41 VU (test record). Regulation: 0.6% at 33 $\frac{1}{3}$  R.P.M.; 0.4% at 78 R.P.M. Power Supply: 105/120 volts, 60 cycles, 35 watts. Dimensions: 25" wide, 23 $\frac{1}{2}$ " deep, 31" high. Weight: 140 lbs., unpacked. Finish: Two-tone umber grey or black. Chromium trim. NOTE: 25 and 50 cycle motors can be furnished on special order.

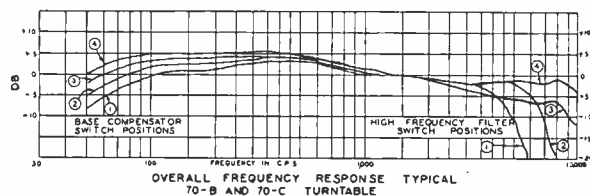

# TURNTABLE ACCESSORIES

## VERTICAL PICKUP ATTACHMENT

Type 71-C

MI-4867



*Showing 71-C Vertical Pickup Attachment Mounted on a 70-C Turntable.*

THE TYPE 71-C vertical tonearm attachment kit has been designed to adapt the Type 70-C turntable so that it may be made to reproduce vertically cut records. It consists of a spring counterbalanced tonearm and a pickup head of the moving coil type with a diamond point stylus. This kit comes complete with mounting hardware and necessary auxiliary transformer and compensation equipment. The characteristic of the 71-C is correctly sloped to provide uniform response from 50 to 10,000 cycles, insuring reproduction fidelity equal to that of any pickup of this type yet developed. The 71-C tonearm added to a 70-C turntable makes the latter a completely universal reproducing equipment, and the use of the two heads is a further guarantee against interrupted program service.

### SPECIFICATIONS

Pickup Type: Vertical. Needle: Diamond point. Frequency Response: 50—10,000 cycles (compensated to reproduce standard vertically cut records). Output Level (Test Record): —55 VU. Shipping Weight: 17 lbs.

## ORTHACOUSTIC REPRODUCING FILTER

For 70-B and 70-C Turntables

MI-4914

THE MI-4914 Orthacoustic Reproducing Filter has been designed to enable users of RCA diamond-point lateral pickups (MI-4856) to obtain the reproducing frequency response curve recommended by the record manufacturers. The filter is completely shielded and may be easily installed in any RCA turntable.

---

## FREQUENCY COMPENSATOR

For 71-A and 71-B Vertical Pickups

MI-4898

THE MI-4898 Compensator is the same as the one furnished with the 71-BI and 71-C Vertical Pickup. It is offered for separate sale to users of 71-A and 71-B Vertical Pickups to enable them to bring their equipment up to date. The MI-4898 Compensator is designed to give a sufficient low frequency boost and a high frequency attenuation in the output of the RCA Vertical Pickup head to produce an essentially flat response of from 50 to 10,000 cycles from present day standard vertical recordings.

---

## BOOSTER AMPLIFIER

for Turntables

MI-11215/4171-25

MANY users of 70-C Transcription Turntables find it desirable to have a booster amplifier mounted in the turntable cabinet. Such an amplifier is particularly advantageous if full frequency compensation is used with the 71-C Vertical Attachment. For this application, the RCA 87-A Booster Amplifier (MI-11215) is recommended. A complete description of the 87-A is given on page 30 of this catalog.

An MI-4171-25 16 db. attenuator pad (250 ohms) may be inserted in the lateral pickup circuit to equalize the program levels from the lateral and vertical pickups.

# RECORDING ATTACHMENT

## Type 72-C

MI-4877



**T**HE 72-C Recording Attachment has been designed for use with the 70-Series Transcription Turntables. Such a combination provides a reasonably priced instantaneous recording equipment with which unusually high quality recording can be made. It can fulfill many needs around the broadcasting station such as recording rehearsals and controversial broadcasts, making records for use by the time salesmen, and recording programs for delayed broadcasts.

The 72-C can be easily and quickly mounted on the 70-C turntable which is furnished with proper mounting holes already drilled. It may be used with 70-A and 70-B turntables by merely substituting an MI-4910 Conversion Platter Kit.

Almost every known device for assisting the operator in producing highly satisfactory recordings has been included in the design of the 72-C. The efficient cutting head has a uniform response between 60 and 6000 cycles. An inertia-type float stabilizer which prevents "flutter" or vertical modulation in the recording.

The swivel mount casting has a knurled thumb nut permitting ready adjustment for horizontal alignment. An improved lowering device permits the operator to gently lower the cutter on to the record, thus avoiding styli breakage or deep cuts from sudden dropping. The angle of the stylus and the depth of cut may be conveniently adjusted even during operation. A spiralling hand wheel permits

spacing between musical selections without breaking the continuity of the groove. A timing scale gives an accurate indication of the remaining recording time and is calibrated for both 78 and  $33\frac{1}{3}$  R.P.M. A three-pin drive prevents slippage or knocks. A lip has been turned on the driving spindle to catch the threads and prevent their climbing into the gears or bearings.

The unit is equipped with an "inside-out" feedscrew which cuts 112 lines per inch. An MI-4876 "outside-in" feedscrew is obtainable on separate order. Precision machining assures uniform lines with a minimum amount of grouping.

The 72-C is furnished complete with standard cutter, mounting base and rest post. If desired, the RCA MI-4887 High Fidelity Cutter may be used, in which case the frequency response will be uniform to 10,000 cycles. The MI-4894 Automatic Recording Equalizer may be mounted directly on the 72-C as mounting holes have already been provided. MI-4899 Mounting Base Kits are available for use on additional turntables.

Recording Styli and blanks may be obtained from RCA. MI-4879-A Steel Styli are available in packages of six and have been manufactured to extremely precise specifications. Each stylus is good for approximately 15 minutes of recording. MI-4878-A Sapphire styli are generally used by experienced recording engineers because they can be used for a number of hours and their use produces a quieter record. Sapphire styli may be resharpened.

## SPECIFICATIONS

Input Power: 3 watts. Input Impedance: 15 ohms, nominal. Frequency Response: 60-6000 cycles. Feed Screw Pitch: 112 lines per inch. Recording Time: 15 minutes on 16" record at  $33\frac{1}{3}$  R.P.M.

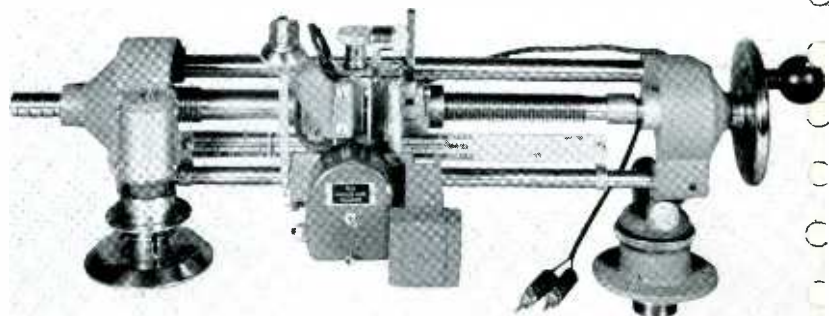

# RECORDING ACCESSORIES

## AUTOMATIC RECORDING EQUALIZER

MI-4894

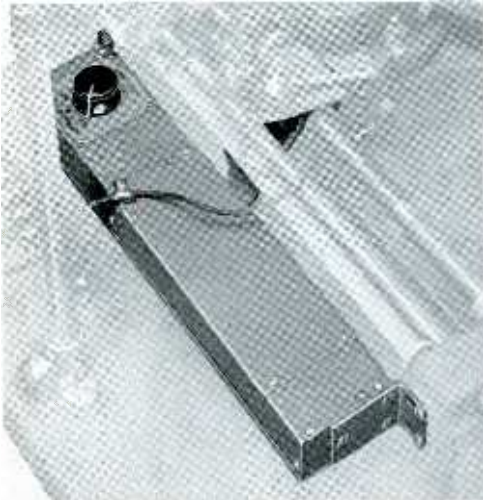

THE MI-4894 Automatic Equalizer is designed for use with 72-A, 72-B, 72-C and 73-A Recording Equipment. It is used to automatically vary the recording frequency response to compensate for the change in reproduction characteristics at various record diameters. Its use is desirable when recording long shows which require more than one record. It prevents a noticeable change in quality when switching from the outside

of one record to the inside of the next, or vice-versa.

The MI-4894 Equalizer consists of a high frequency boost circuit having constant loss at low frequencies. The compensating circuit is varied by means of a potentiometer whose slider is mechanically linked to the cutter head carriage and driven by the carriage along the lead screw. Assembled on the equalizer is a 4-position switch, two positions of which provide +9 db. and +12 db. compensation at 7,000 cycles when the cutter is at the center groove of the record. The other two positions provide fixed compensation of +9 db. and +12 db. at 7,000 cycles. These compensation values increase to 12 db. and 13 db. respectively at 10,000 cycles.

The potentiometer contacts are enclosed and a section of the shield is removable for cleaning and servicing the contact arm. A special set of mounting brackets is furnished for each type of recorder. When ordering, specify type brackets desired.

### SPECIFICATIONS

Input Impedance: 250/300 ohms. Output Impedance: 250/300 ohms. Input Level: +11 VU. Insertion Loss: 14 db. at 100 cycles for 250 ohm load. Dimensions: 12¼" long, 5½" deep, 2¼" high. Weight: 2¼ lbs., unpacked.

## HIGH FIDELITY RECORDING HEAD

MI-4887

THE MI-4887 High Fidelity Recording Head has been designed for use with the RCA 72-B and 72-C Recording Attachments as well as with the 73-A Deluxe Recording Equipment. Its use permits a much higher recording level than can usually be obtained with similar units. The MI-4887 has a uniform frequency response from 30 to 10,000 cycles and distortion in records made with it is extremely low.

The MI-4887 recording head is a band pass mechanical network terminated in a dry mechanical resistive material. The armature is of the balanced type and is centered by



means of a tempered steel spring. The armature is supported on rugged knife edge bearings. Pole pieces are of nicoloi. Since the weight of a thumbscrew cannot be tolerated in a wide range head, a small clamping screw is provided and can be tightened with a small jeweler's screw driver which is furnished.

An impedance compensating network is furnished with the MI-4887 Head and the total input impedance remains sufficiently close to 15 ohms throughout the frequency range. An amplifier having at least 8 watts output is recommended to provide a safe margin for driving the cutter.

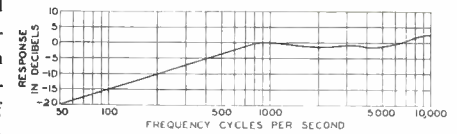

Frequency response of MI-4887 based upon optical measurement of the stylus tip motion for constant input

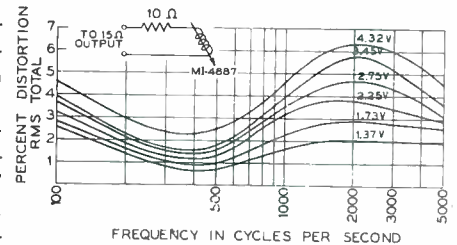

Distortion measurements made on the MI-4887 Recording Head

## ORTHACOUSTIC RECORDING FILTER

MI-4916

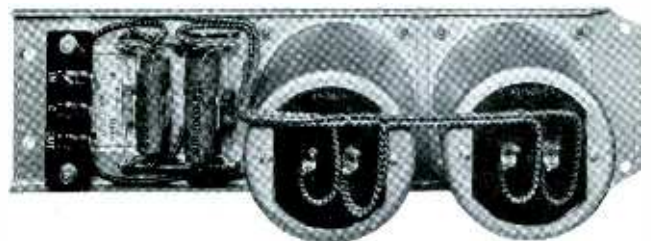

THE MI-4916 Orthacoustic Recording Filter has been designed for use with the MI-4887 Recording Head. When used with the MI-4887 Head, the MI-4916 Filter produces a recording frequency characteristic which is approximately 14 db. below the 500 cycle level at 100 cycles and approximately 15 db. above the 1,000 cycle level at 10,000 cycles. The response is uniform between 500 and 1,000 cycles. Such a frequency has been chosen as the most desirable for best reproduction of transcription records.

The MI-4916 Filter has a 1,000 cycle insertion loss of 17 db. and its input source impedance and output load impedance is 250 or 600 ohms. It should be inserted in the circuit ahead of the Recorder Power Amplifier. It has a maximum input level of +3 VU. The reactors have been carefully shielded and the hum pickup level is less than -126 VU when the unit is at least 6 inches from a power transformer. The overall dimensions are 12⅝" long, 3⅞" wide and 4⅞" high and the weight is 6½ lbs., unpacked. Holes are provided for mounting the unit on 36-A or 36-B Shelves, if desired.

# RECORDING EQUIPMENT

## Type 73-A

MI-4915



**T**HE 73-A Recorder is a professional type unit which has been designed to cut high quality instantaneous recordings for broadcasting purposes. It is a precision device which will meet the most exacting requirements of the art.

With the 73-A, it is possible to record at either  $33\frac{1}{3}$  or 78 R.P.M., outside-in or inside-out at 96, 112, 120, 136 or 154 lines per inch. The speed and groove adjustments are easily and quickly made by turning a knob—there are no bothersome gears or belts to change. A lathe-type construction provides a maximum rigidity for the feedscrew and carriage assembly and allows quick and convenient change of record blanks. An improved cutter head lowering mechanism may be operated with but one hand and is designed to prevent damaging stylus and record. Convenient thumbscrews provide accurate adjustments for stylus angle and depth of cut. Two large motors simultaneously rim-drive the heavy turntable. The use of two motors provides high torque, excellent regulation and low slippage. An RCA MI-4887 recording head makes recordings with a 30 to 10,000 cycle frequency response and with higher amplitude and lower distortion. A newly developed oil-

damped inertia-type stabilizer prevents “flutter” from vertical modulation. The stabilizer is in a sealed container which eliminates any possibility of oil leakage.

A handwheel is provided on the feed screw and permits the cutting of “spirals” for the purpose of separating recordings on the same record or for cutting a lead-in spiral at the start. Complete circles may be cut by lifting the feed lever. Four hexagon timing scales are furnished. They provide calibrated time indicators for both speeds and both directions of cutting.

A high quality microscope is furnished for observing the grooves. It is mounted on an adjustable arm which permits it to be moved to any part of the record. A small shielded lamp is also mounted on the arm and is independently adjustable so as to illuminate the grooves under observation. A shielded general illumination lamp is supported by a long flexible “goose neck” and may be moved to any desired position.

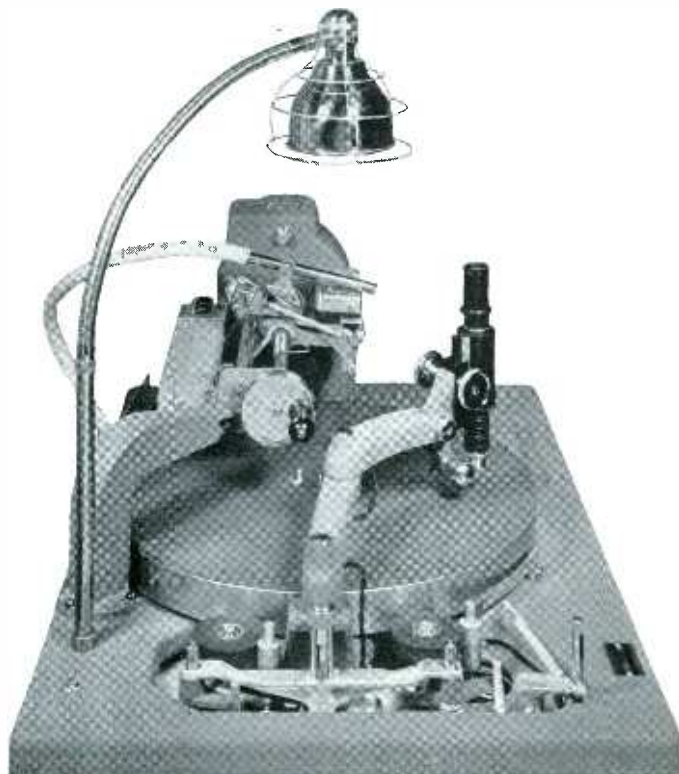



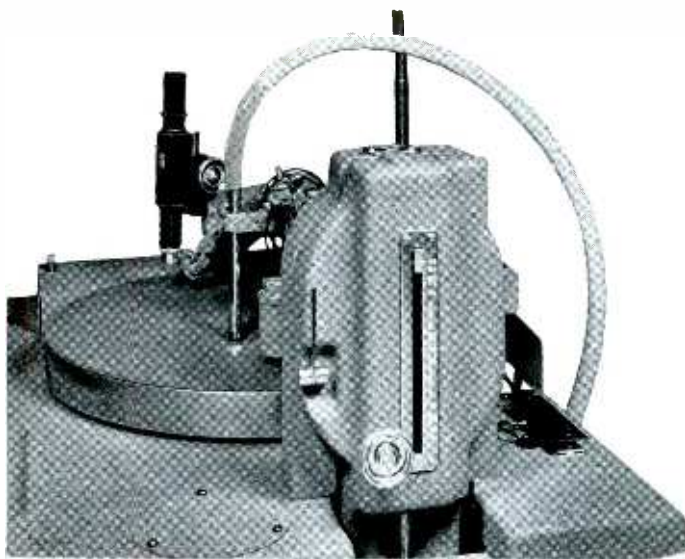

*End view of 73-A showing feed screw direction and pitch adjustment.*

The unit is equipped with a heavy cast base designed to be mounted in a table or bench. It is shipped on a wooden frame which may be used as a temporary mounting. The motors are doubly rubber shock-mounted from the motor board to avoid motor rumble in the recordings. The entire motor board is shock mounted to restrict building rumble and vibration. The driver pulleys use thick tires of special rubber, are unusually quiet and give long life. The turntable platter accommodates 17 $\frac{1}{4}$ " record blanks and is equipped with one driving pin which may be depressed into the platter for blanks without holes. A removable rubber mat on the platter provides a good record base and may be readily cleaned. The two separate motors and turntable drive wheels are both controlled by one "on-off" switch; and both mechanisms are controlled by one "speed-change" switch. When the motor switch is turned "off" the driving rollers are disengaged and a brake is applied to the rim of the turntable, bringing it quickly to a stop. The stainless steel feed screw is driven by a planetary-drive mechanism utilizing a rubber-tired roller on a vertical shaft and a flat disc on the end of the horizontally mounted feed screw. The driving roller may be adjusted to various vertical positions across the disc—the speed and direction of rotation of the feed screw being determined by the roller's position with respect to the center of the disc. The

roller is automatically disengaged from the disc whenever the cutter head carriage is raised to the rest position.

The 73-A has been drilled for conveniently installing the MI-4894 Automatic Equalizer and MI-4875A Pickup and Tone Arm which are available as is the MI-4916 "Orthacoustic" Fixed Equalizer. The RCA 82-B and 94-D Amplifiers are recommended for use with the 73-A Recorder.

The 73-A is supplied equipped with an adjustable suction nozzle. A suction pump (MI-4922) and coupling hose (MI-4923) are available on separate order. The MI-4922 Suction Pump is operated by a universal motor and will operate on 25, 50 or 60 cycles, 110 volts AC as well as 110 volts DC. The pump is capable of establishing a 55" vacuum head of water which provides sufficient suction to satisfactorily operate two 73-A Recorders. The MI-4923 Coupling Hose Kit consists of 10 feet of 1 $\frac{1}{4}$ " flexible 3-ply tubing, 12 feet of  $\frac{3}{8}$ " I.D. white rubber hose, one cast copper 90° Y branch and two copper bushings. (See photograph below.)

## SPECIFICATIONS



Recording Speed: 33 $\frac{1}{3}$  and 78 R.P.M. Speed Variation: 33 $\frac{1}{3}$  R.P.M.—0.3% max. 78 R.P.M.—0.2% max. Rumble: 35 to 40 db. below average signal level at 80% modulation with 112 grooves per inch. Slip-page: Less than 1%. Recording Direction: Equipped for inside-out and outside-in. Recording Pitch: Continuously variable with indicated stops at 96, 112, 120, 136 and 154 lines per inch. Frequency Response: 30 — 10,000 cycles within  $\pm 2$  db. of curve given for MI-4887 recorder head (optical measurement). Input Impedance: 15 ohms nominal. Audio Power: 8 to 16 watts. Power Supply: 105/125 volts, 60 cycles. 130 watts less lamp. Dimensions: 30" wide, 20 $\frac{1}{2}$ " deep, 25" high. Weight: 207 lbs., unpacked.

# PORTABLE RECORDING EQUIPMENT

## Type OR-1

MI-11210



**T**HE OR-1 Portable Recording Equipment is a reasonably priced assembly which includes all the equipment necessary for cutting high quality instantaneous recordings in the studio and outside at remote locations. It is a complete recording channel with the exception of the microphone and consists of an MI-11211 Turntable, an MI-4877 (Type 72-C) Recording Attachment and an MI-11212 Amplifier and Loudspeaker Unit. These items may be obtained separately for other applications, if desired. The MI-11211 Turntable and the MI-11212 Amplifier and Speaker unit may be used, less the recording attachment, as a high-fidelity record player for demonstration and sales purposes.

The MI-11211 Portable Turntable consists of a 16" aluminum turntable which is rim driven by a high quality synchronous motor. An unique feature is the use of *two* rubber-tired driver wheels between the motor shaft and the turntable rim. The use of

two driver wheels reduces the slippage to less than 1%. The "off-on" switch disconnects the power and releases both driver wheels to prevent "flats" from developing in the rubber. The driver wheels use thick tires of special rubber, which are quiet and long lasting. The turntable operates at 78 and 33 $\frac{1}{3}$  R.P.M.; the speed change is made by turning a single knob. The use of properly coordinated turntable and motor results in a "wow" factor of less than 0.5%. The unit is equipped with an RCA high-fidelity pickup and tone arm with permanent diamond point stylus and a uniform frequency response between 30 and 10,000 cycles. The driving motor is carefully rubber shock mounted from the motor board and the rumble is below audibility. The motor board is made of aluminum to keep the weight to a minimum.

A compartment is provided in the carrying case for the 72-C Recording Attachment when it is not in use.



*Showing method of mounting recording attachment while transporting unit.*

The MI-11212 Amplifier and Speaker Unit contains a 12 watt amplifier which has a gain of 105 db. The amplifier includes a built-in AC rectifier, has a frequency response of  $\pm 2$  db. from 30 to 15,000 cycles, a noise level which is  $-60$  db. below signal, and a distortion content of less than 3% R.M.S. at full output when measured at any frequency between 50 and 7,000 cycles. A complete single stage preamplifier with input and output transformers is included as a part of the amplifier. This provides a 600 ohm circuit after the preamplifier for the insertion of equalizers, if desired.

Mounted in the removable lid are two RCA "Accordion Edge" Speaker Units enclosed in a sealed compartment for proper cone loading and low frequency response. A "playback-record" switch is mounted on the front panel and transfers both the input and output circuits of the amplifier. When thrown to the "playback" position, the input of the amplifier is connected to the pickup and the output to the loudspeakers. When the switch is in the "record" position, the input of the amplifier is con-

nected to the input selector switch and the output to the recorder head. Two external input terminations are provided; one is a Cannon microphone receptacle for a 30 to 250 ohm microphone and the other is on insulated binding posts for bridging a 600 ohm line. The gain control is a high quality step-by-step potentiometer. A cut-out is provided in the front panel for the installation of an MI-11251 VU Meter Kit for monitoring the recording level, if desired. A monitoring headphone jack, a power switch and a fuse are also located on the front panel for ready accessibility. The unit is furnished with AC power cord and with a turntable interconnecting cable which is equipped with a Cannon plug to fit the receptacle in the MI-11211 Turntable.

The 72-C Recording Attachment is described in detail on page 46 of this catalogue.

Available attachments are the MI-11251 VU Meter and Attenuator Kit, the MI-11259 Kit of Tubes, the MI-4894/4913-2 Automatic Equalizer, the MI-4887 High Fidelity Recording Head, and the MI-4916 Fixed Orthacoustic Equalizer.



The MI-11211 Turntable and the MI-11212 Amplifier and Speaker Unit are mounted in matching reinforced carrying cases. Substantial handles are provided so each unit can be carried by either one or two persons.

# CABINET TYPE SPEAKER

MI-4400 Umber Gray  
MI-4400A Transmitter Gray

Type 64-B

MI-4400B Black  
MI-4400C Walnut



**T**HE TYPE 64-B Monitoring Loudspeaker supersedes the type 64-A and 64-AX speaker that proved to be a very popular unit for use as a monitor in control rooms, auditioning booths, offices and other points about the studio. This speaker consists essentially of three items; namely, the cabinet, the speaker mechanism and the high frequency diffuser. These com-

ponents have been designed so that acoustically they properly operate in conjunction with each other.

The cabinet houses a series of acoustic filter chambers of increasing size which open into the large grill at the bottom of the unit. This arrangement provides the equivalent of an 8 foot baffle. The cabinet is rigidly braced so as to eliminate tone distortion due to vibrating members, walls or back. The closed back makes it possible to locate the unit at any distance from a wall without affecting the frequency response.

The speaker mechanism is a six inch, double voice coil unit employing a permanent magnet for field excitation. (A 6-inch 110 volt electromagnet double voice coil speaker, MI-4411, is also available for use with this cabinet.) The design of the speaker unit provides a reproduction of frequencies over a much wider range than the ordinary type of speaker. The speaker itself is mounted behind the top grill in the small opening of the acoustic filter chamber. Directly in front of the cone is a four vane high frequency diffuser which provides a wide angle distribution of the high frequencies. Thus the combination of a double voice speaker plus the horn and high frequency diffusing vanes provides a high quality speaker having a frequency range of 60-10,000 cycles with a good wide spread of high frequencies.

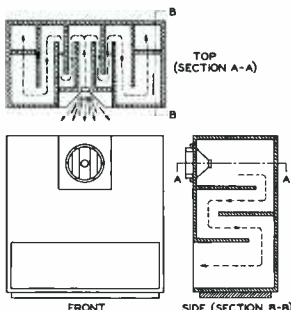

FRONT AND CROSS-SECTIONAL VIEWS SHOWING FOLDED HORN CONSTRUCTION IN RCA 64-B LOUDSPEAKER CABINET. DOTTED LINES INDICATE PATH OF SOUND WAVES.

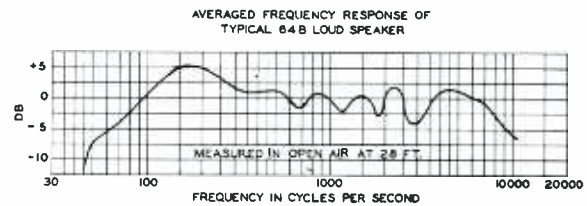

The 64-B Monitoring Loudspeaker can be operated from the Type 82-B or 94-D Monitoring Amplifier. These amplifiers have sufficient output capacity to operate more than one loudspeaker and are capable of providing field excitation for the electro-magnetic speaker, MI-4411.

## SPECIFICATIONS

Input Impedance: 15 ohms, nominal. Power Input: 10 watts, maximum. Field: MI-4410—Permanent magnet. MI-4411—Electromagnet 100 volts, 100 ma. Frequency Response: 60-10,000 cycles. Finish: Umber gray, transmitter gray, black or walnut. Dimensions: Height 33", width 29", depth 19". Weight: Cabinet 78½ lbs. MI-4410 Speaker, 11 lbs. MI-4411 Speaker, 12 lbs.

## 64-B MONITORING CABINET SPEAKER BASE

MI-4405 Umber Gray  
MI-4405A Transmitter Gray

MI-4405B Black  
MI-4405C Walnut

THE MI-4405 base may be conveniently placed below the 64-B Speaker Cabinet, and may be used as a means of locating the monitoring amplifier or field power supply.

This base is designed so that, when combined with the 64-B, it appears as a unit design.

## SPECIFICATIONS

Dimensions: Height 14", width 29½", depth 19½". Weight 27 lb.

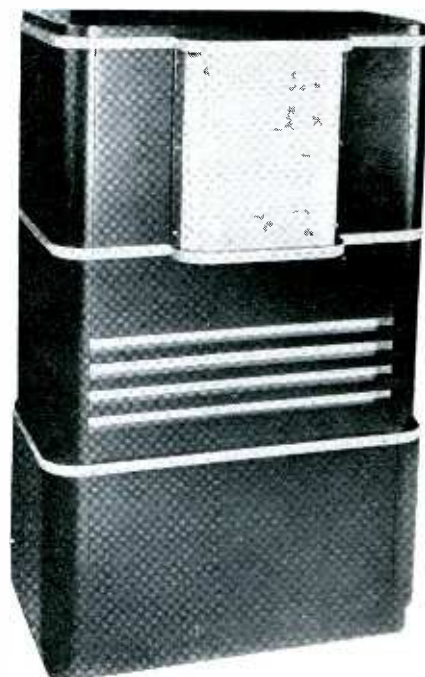

The 64-B with the base

# RCA MONITORING LOUD SPEAKERS

## FLOOR CONSOLE SPEAKER

MI-6222/6224/4-6234

THE MI-6222 speaker with baffle and transformer assembly, MI-6224, and 4 MI-6234 speaker mechanisms may be used where the high fidelity response of the 64-B is not required. An acoustic phase inverter is built into the cabinet to extend the low frequency response. The cabinet is finished in walnut only and its appearance and size makes it an economical unit to use for office monitoring.



### SPECIFICATIONS

Size: Height 32", width 24", depth 14 $\frac{1}{8}$ ". Weight: Cabinet—30 lbs., unpacked. Speaker Assembly—17 lbs., unpacked. Finish: Polished walnut. Combined Voice Coil Impedance: 15 ohms, nominal. Frequency Response: 50-8000 cycles. Input Power Rating: 12 watts, maximum. Speaker Mechanism: Four MI-6234 "Accordion" type permanent magnet mechanisms.

form response of 90 to 8000 cycles and a useful response of 30 to 14,000 cycles.

### SPECIFICATIONS

Power Input: 10 watts maximum. Input Impedance: 15 ohms, nominal. Field Supply Requirements: MI-4460, 56 volts at 215 ma. MI-4461A, 110 volts at 100 ma. Dimensions: 10 $\frac{1}{2}$ " overall diameter, 8" overall depth. Weight: 18 $\frac{1}{2}$  lbs., unpacked. Frequency Response: 60 to 10,000 cycles. Determined by baffle.

## AUDITORIUM WALL SPEAKER EQUIPMENT

MI-6223/6237

THE MI-6223/6237 speaker equipment can be used to advantage in large theatre studios for cueing and talk-back purposes. The cabinet houses one MI-6237—15" permanent field dynamic speaker which has excellent low-frequency response. The cabinet is finished in umber gray.

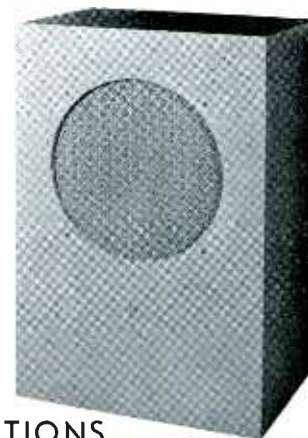

### SPECIFICATIONS

Size: High 28", wide 18 $\frac{7}{8}$ ", deep 13". Weight: Cabinet, 20 $\frac{1}{2}$  lbs. Speaker, 13 $\frac{1}{4}$  lbs. Speaker: Permanent magnet, 15 inch cone. Frequency Range: 60-4000 cycles. Input Impedance: 8 ohms, nominal. Power Input: 15 watts, maximum. For impedances other than 8 ohms the auto-transformer MI-12315 should be used.

## ACCORDION CONE SPEAKER ASSEMBLY

MI-6233

THE MI-6233 accordion cone wall mounted type speaker assembly can be used to advantage as an office monitor or talk back speaker for small studios. The accordion cone speaker is acoustically matched to the cabinet. The cabinet has a closed back, thus insuring the same reproduction from the speaker regardless of its spacing from the wall or the texture of wall material.

The unit is complete with housing, speaker and matching transformer.



### SPECIFICATIONS

Cabinet: 18" high, 12" wide, 6 $\frac{3}{4}$ " deep. Speaker: Permanent magnet. Frequency Response: 80-7000 cycles. Input Impedances: 2/6/15/35/54/225/342/438/500 ohms. Power Input: 3 watts, maximum. Weight: 8 $\frac{1}{2}$  lbs.

## TALK-BACK AND CUEING SPEAKER

MI-6261/6294

FOR talk-back and cueing purposes a low priced speaker is often desirable. The RCA MI-6261 speaker mechanism and MI-6294 cabinet make it an ideally suited combination for such applications. The speaker is a large, high power, permanent magnet type that gives high quality reproduction. Features include use of Alnico magnet structure, sealed voice coil, corrugated cone construction and a power handling ability of 10 watts. The wooden cabinet has a sloping front and is designed for the speaker mechanism.



### SPECIFICATIONS

Size: Cabinet—14 $\frac{1}{2}$ " wide, 16 $\frac{1}{2}$ " high, 10 $\frac{5}{8}$ " deep. Speaker—12 $\frac{1}{2}$ " overall diameter, 6 $\frac{3}{4}$ " overall depth. Weight: Cabinet, 4 lbs., unpacked. Speaker, 6 $\frac{1}{2}$  lbs., unpacked. Power Input: 10 watts maximum. Input Impedance: 15 ohms, nominal. Frequency Response: 100 to 5000 cycles.

## UNMOUNTED UNITS

Type UZ-4209, Stock MI-4460, 56 volt field  
Type UZ-4309, Stock MI-4461A, 110 volt field

THE TYPES UZ-4209 and UZ-4309 Units are unmounted 8" high-fidelity loudspeakers especially designed for use with RCA Deluxe Speech Input Systems. They are particularly useful in control booths, and other locations where floor space is limited, in that they can be mounted on flat baffles and suspended from the ceiling or wall. Mounted in a large flat baffle, they have a uni-



# REMOTE AMPLIFIER

## Type OP-6

MI-11202



**T**HE OP-6 Portable Amplifier has been developed to provide the broadcaster with outside pick-up equipment which will give studio-quality performance at a minimum of expense. The OP-6 is complete and contains a built-in AC power supply. It may be used with batteries, however, if AC power is not available. Compact and light in weight, it is convenient to carry. Because it is relatively inexpensive, the OP-6 is an ideal unit to be left at those remotes from which repeated pickups are made.

The complete amplifier and power supply is enclosed in a steel case with removable cover, rubber feet, and steel reinforced leather handle. The handle lies flat when not in use. A leather shoulder strap facilitates transporting the unit and leaves the hands free to carry microphones, etc. The unit is furnished, less meter, thereby avoiding additional expense for those applications where a meter is unnecessary. The MI-11251 VU Meter Kit can be added at any time. The chassis and front panel may be easily slipped from the case by removing four thumb-screws.

Three stages of amplification with RCA-1620 low-noise, non-microphonic tubes give a gain of 90 db.—more than ample for high-quality microphones. One RCA-6X5 is used as the rectifier. The use of only two types of tubes simplifies the stocking of spares. A new and unique circuit utilizes two feed-back loops. One loop is around the first stage and is varied with the main gain control thus maintaining a maximum feed-back consistent with the required gain. This arrangement prevents overloading the first tube by high-output microphones. The second feed-

back loop is fixed and is connected around the second and third stages. The gain control is located between the first and second stages and is a high quality step-by-step device equipped with a large knob. Two inputs are provided and either may be selected by means of a turn-key switch. One input is brought to shielded screw terminals and the other to a standard cannon microphone receptacle. The output terminates on insulated binding posts which are located on the front panel for greatest accessibility. The power input receptacle has a number of contacts which are used for altering the circuit for AC or battery operation. An AC power cord is furnished with the amplifier and the DC battery cord is supplied with the MI-11214 Battery Box. Located on the front panel are the power switch, fuse and monitoring headset jack.

Available accessories for the OP-6 are the MI-11251 VU Meter and Attenuator Kit, MI-11256 Weatherproof Fabric Cover, MI-11253 Kit of Tubes, MI-11214 Battery Box, MI-11255 Kit of Batteries, OP-7 Four Channel Mixer (see next page), and the MI-4630-B Cannon Microphone Plug.

### SPECIFICATIONS

Input Source Impedance: 30/50 or 250 ohms. Output Load Impedance: 150 or 500/600 ohms. Gain: 90 db., maximum. Output Level: +19 VU with less than 1% R.M.S. distortion when measured at any frequency between 50 and 7000 cycles. Frequency Response:  $\pm 1$  db. 40 to 10,000 cycles.  $\pm 2$  db. 30 to 15,000 cycles. Noise Level: -59 db. (unweighted) below +8 VU level at 70 db. gain. Tube Complement: Three RCA-1620 and one RCA-6X5. Dimensions:  $12\frac{3}{8}$ " long,  $7\frac{1}{4}$ " deep, and  $9\frac{1}{2}$ " high. Weight:  $20\frac{1}{2}$  lb. (unpacked) including 8' power cord. Finish: Grey wrinkle.

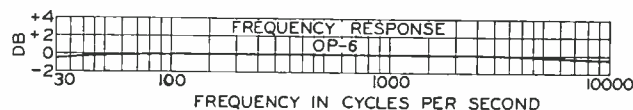

# PORTABLE MIXER AMPLIFIER

## Type OP-7

MI-11213



**T**HE OP-7 Mixer Amplifier is a companion unit for the OP-6 and provides high-level mixing of up to four microphones without the increased circuit-noise of low-level mixers. It consists of four single stage pre-amplifiers and is complete with a built-in AC rectifier. It can be operated from an external battery supply, if desired. The general type of construction, handle, shoulder strap and finish agree with that of the OP-6 but the OP-7 can be used with any type program amplifier having a gain of 80 db. or more. The front panel contains the power receptacle, "on-off" power switch, AC fuse, four mixer knobs and output terminals.

Four Cannon type microphone receptacles are located on the back of the unit and are assembled on the amplifier chassis. A fifth Cannon receptacle provides an output connection. A suitable OP-6 interconnection cable equipped with Cannon plugs is furnished with the OP-7. Shielded output terminals are also provided. A cover is held in place by two snap-type clasps, protecting the front of the unit. The power and interconnection cables are carried in the cover.

The mixers are located

interstage and are of the logarithmic continuously variable carbon type designed for long-life operation. Sufficient space is available to permit the use of step-by-step attenuators, if desired.

The OP-7 Mixer Amplifier and the OP-6 Field Amplifier provide a combination that is capable of handling a large variety of pickups with the minimum of equipment but with a quality of reproduction equal to most studio installations. The two units may be operated side by side or one unit may be placed on top the other.

Accessories for the OP-7 are the MI-11256 weatherproof Cravenette Cover, the MI-11254 Kit of Tubes, the MI-11214 Battery Box, the MI-11255 Kit of Batteries and the MI-4630-B Cannon Microphone Plugs.

### SPECIFICATIONS

Input Source Impedance: 30/50 or 250 ohms. Output Load Impedance: 30 ohms, 250 ohms, or high impedance preamplifier. Overall Gain: 9 db. Maximum Output Level: -24 vu. with less than 1% R.M.S. distortion when measured at any frequency between 50 and 7000 cycles. Frequency Response:  $\pm 1$  db., 40 to 10,000 cycles.  $\pm 2$  db., 30 to 15,000 cycles. Noise Level: -60 db. below -62 vu. output. Tube Complement: 4 RCA-1620 and 1 RCA-6X5. Dimensions:  $12\frac{3}{8}$ " long,  $8\frac{1}{4}$ " deep,  $9\frac{1}{2}$ " high. Weight: 22 lbs., including OP-6 interconnecting cable and power cord. Power Supply: 105/125 volts, 50/60 cycles, 80 watts. Finish: Grey wrinkle.

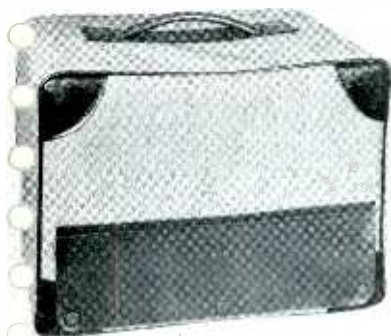
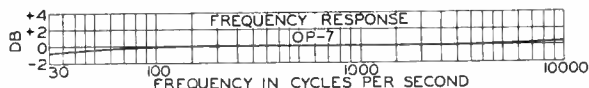

MI-11256 Cover for OP-7

## BATTERY BOX FOR OP-6 AND OP-7 AMPLIFIERS

MI-11214

**T**HE MI-11214 Battery Box has been designed especially for use with the OP-6 and OP-7 Remote Amplifiers. It is equipped with two interconnection cords so that it can be used with both amplifiers simultaneously if desired. The box is constructed of steel with durable grey wrinkle finish and is equipped with a large steel reinforced handle and rubber feet. The cables are stored in the cover when not in use.

The maximum capacity of the box is 15 No. 4F Burgess "A" batteries and 6 No. B-30 Burgess "B" batteries or equivalent. 15 "A" batteries sufficient to operate the OP-6 continuously for 34 hours, the OP-7 for 30 hours, and the OP-6 plus the OP-7 for  $7\frac{1}{2}$  hours. As a service to the customer RCA stocks MI-11255 Battery Kits which

consist of 10 "A" batteries and 6 "B" batteries. These kits will operate the OP-6 for 16 hours and the OP-6 plus the OP-7 for 3.5 hours. If the OP-6 is to be used on batteries only, approximately 8 hours longer battery life can be obtained if 2 RCA-6W7G tubes are substituted for 2 of the RCA-1620 tubes.

Height  $12\frac{1}{2}$ ", width  $13\frac{1}{2}$ ", depth  $8\frac{3}{4}$ ". Weight (unpacked)  $15\frac{1}{2}$  lbs., weight (including batteries) 44 lbs. Battery connection leads are supplied.

A weatherproof cover, MI-11258, is available.



# FIELD AMPLIFIER EQUIPMENT

OP5—250 ohms—MI-4223C  
OP5X—250 ohms—MI-4223G  
OP5X—30 ohms—MI-4223E

## OP-5 A New and Flexible Battery Operated Unit



**T**HE OP-5 is a battery operated field amplifier which will appeal to every station because of its small size, its low price, its flexibility and completeness as well as its high fidelity performance. Designed for broadcast use outside of the studio, the OP-5 has been constructed to conform to the recommendations of leading broadcast engineers.

The OP-5 is unusually light and portable. Weighing only 36 lbs. completely loaded with batteries, it is scarcely larger than a good size briefcase and is easy to carry through taxi doors or to inaccessible locations. In spite of the light weight, shielding is complete; strong but light-weight alloys make the case and framework husky and able to stand hard usage.

Engineers will appreciate its completeness and flexibility. Containing provision for mixing four high fidelity, low output level microphones, the OP-5 is provided with an illuminated V. I. meter (and a separate light battery) which can be switched to read battery voltages and tube plate currents. OP-5X Models are also available with the newly recommended vu meter movement and 1 milliwatt zero reference calibration. Line key switches enable either of two lines to be connected to the output of the amplifier or to a socket where an interphone may be plugged in. Other controls include a power switch, filament rheostat, V. I. multiplier tap switch, master gain control and light

switch. Tubes are reached by a door in the front panel and the entire chassis may be removed from its case by loosening four thumb screws.

The circuit of the OP-5 is straightforward including four resistance coupled stages with transformer input and output. The specially developed RCA 1609 pentodes are used. These tubes result in high gain with low battery drain and have been especially constructed to avoid microphonic troubles. Feedback is employed to insure minimum distortion and to provide a more exact impedance match with lines differing slightly from 500 ohms.

Performance of the OP-5 is particularly good. The distortion is below 0.6% RMS from 50 to 4000 cycles. Frequency response is uniform from 30 to 10,000 cycles within  $\pm 1$  db. The noise level will be less than  $-58$  db. for normal operation. The overall gain, 90 db. is sufficient for high fidelity microphones. This equipment therefore, forms suitable apparatus for every remote program from sports to symphony concerts.

The self-contained batteries of the OP-5 enable it to be used anywhere, regardless of power supplies and without the necessity of making connections. The dry batteries used provide for long life and minimum expense. In every respect, in fact, the OP-5 is an unusually useful and convenient field amplifier which every station can well afford to own. A kit of batteries is stocked as MI-10801.

For protecting the OP-5 case against wear and weather, a covering case is available. It is made of "Cravenette" and provided with a zipper fastening. Stock No. MI-11600.

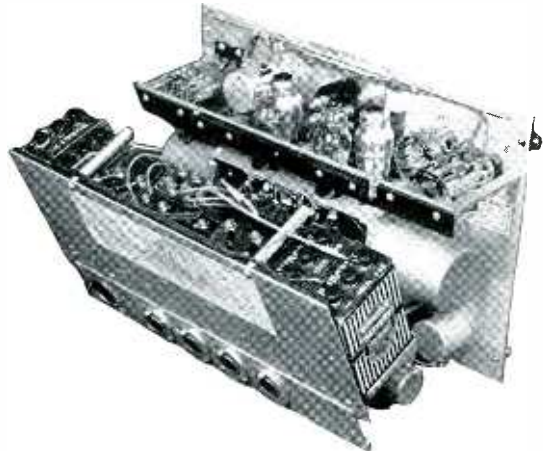

Rear View of the OP-5. Partially Opened. Battery Mounting Hinges to Permit Complete Accessibility to All Parts



### SPECIFICATIONS

Impedances: Input, 250 ohms or 30 ohms, as specified. Output, 500/600 ohms. Output Level: +19 VU db. maximum. Gain: 90 db. overall. Fidelity: Flat  $\pm 1$  db. 30—10,000 cycles. Distortion: Less than .6% R.M.S., 50—7,000 cycles at +14 VU output. Noise Level: Below  $-47$  VU. Tubes: Four—RCA-1609. Batteries: 2 Little 6 dry cells (Burgess No. 4 F. H.) 1 C. Battery (Burgess A8BP). 1 C Battery (Burgess 2370). 4 45V B Batteries (Burgess Z-30-NX). Receptacles: 4 Cannon Microphone Receptacles; and Hubbell 2 connector socket for interphone; binding posts for 2 lines located on front of panel. Dimensions:  $11\frac{3}{4}$ " high,  $18\frac{1}{4}$ " long,  $8\frac{1}{2}$ " deep. 36 lbs. weight fully loaded. Finish: Gray wrinkle. Tube Kit: MI-10651.



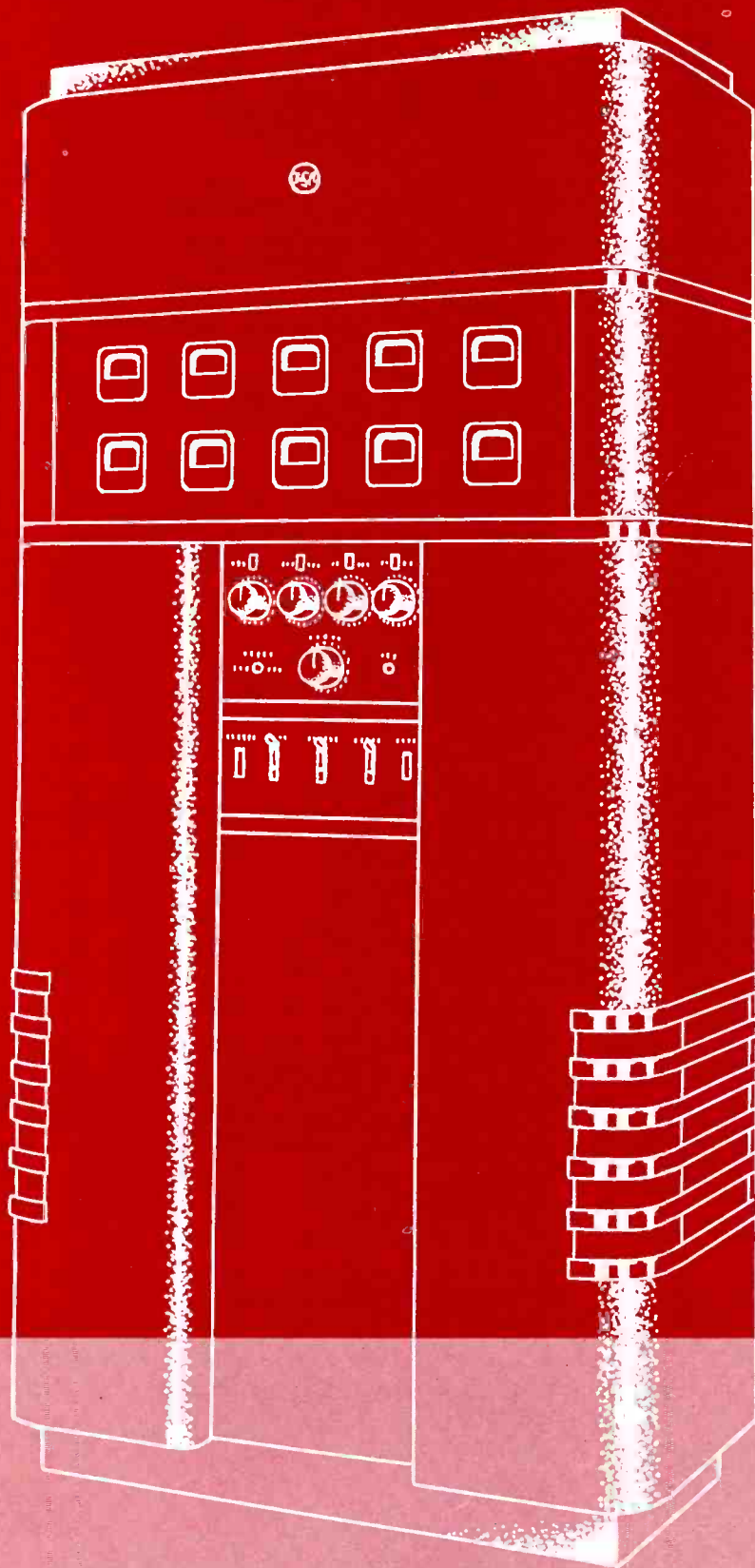

# TRANSMITTERS

# TRANSMITTERS

**I**N presenting transmitters for broadcast service RCA has made performance and reliability the keynote of the design. Definite requirements must determine the circuit, the arrangement of components and the tube complement. It is not enough merely to build equipment which has a novel circuit unless it contributes to the performance. Features alone can mean nothing unless they furnish the purchaser with definite value. For years RCA engineers have investigated the problems of the broadcast station in order to construct functional apparatus which will exactly meet the requirements of the user. Nothing is included which does not serve a useful purpose and nothing is omitted which is essential for good operation.

Performance is, of course, the prime consideration. Broadcast service demands a high standard of transmission quality and RCA transmitters are designed to provide uniform audio response within extremely close limits as well as low distortion and noise level. In RCA transmitters, distortion has been reduced to a point where it is no longer a noticeable factor, not only at the common measuring point of 400 cycles, but over the entire audio band from 50 to 7500 cycles. This has required careful design, but low distortion at one frequency is of no particular benefit if distortion is high at other frequencies. Likewise, noise level has been suppressed to a value where it does not limit the dynamic transmission range.

Economy of operation is important to the broadcaster and has been one of the chief design considerations. The selection of tubes, the type of circuit and the power supply systems have been arranged to reduce the hourly cost of operation. Since operating expense may be, during the life of the transmitter, of equal or greater amount than the initial cost of the equipment, savings which accumulate month after month reflect a very definite economy. Hence both tube cost and power drain have been very appreciably reduced. Part of the low tube cost is attained through the use of types which render many thousands of hours of service. Long tube life is a dividend to the station owner and RCA tubes help reduce the annual replacement expenditures.

Reliability is another essential factor. The loss of only a few hours time and the equivalent revenue might run into large figures. Hence RCA equipment is built to reduce outages to a minimum. Components are conservatively rated and of careful design to prevent failures. Only high grade materials are employed, and control circuits are designed to protect the apparatus against damage in any emergency.

Convenience of operation has also been given careful consideration. The equipments are physically small to avoid the need for large buildings, but not so small that

accessibility is sacrificed. RCA transmitters avoid circuits which require laboratory apparatus for proper adjustment and their straightforward circuits are a guarantee of reliable operation. Many other features of the design contribute to convenient operation, such as ready access to tubes and components, complete metering, automatic sequence starting and automatic power change devices. RCA transmitters are shipped assembled and with but a few parts removed for safety during transit. Thus time and money are saved during installation.

RCA design goes far beyond the requirements of the accepted standards for good engineering practice, and features incorporated may not be readily apparent on casual examination. Some insulation looks like Ceramic or Mycalex, but RCA insists on using high grade materials which will not absorb moisture nor develop high resistance leakage. Rust proofing on metal cabinets and frames is covered by the exterior finish, but it still exists as a layer of protection against corrosion. Deficiencies in design could be minimized by compensation, but it is often dangerous to depend upon corrective measures as a substitute for good engineering, and RCA does not tolerate such practice.

Another factor which is not immediately apparent, but of prime importance to the purchaser, is the careful test of components and of the overall equipment. RCA insists on thorough testing of each piece of apparatus before release from the factory.

The process of design of new equipment, as carried out in RCA laboratories, is thorough in the extreme. After the circuit design has been completed on paper, a model is usually made, on which elaborate measurements are carried out. From this, the finished design is evolved and the final model is subjected to many tests of use and misuse. Every sort of operating condition is duplicated as nearly as possible in order to assure trouble-free service. Elaborate test equipment is necessary and due to RCA's extensive facilities, this is readily available and utilized. Thus when an RCA transmitter is delivered to the station, the purchaser can be assured that every precaution has been taken to provide high fidelity, economical, trouble-free operation.

Back of the transmitters which RCA offers for sale, lies capable engineering, extensive production facilities, a careful test system and an organization determined to produce functional apparatus at reasonable prices. That is why many stations insist on RCA equipment throughout. Note the individual features of the transmitters described in the following pages and see why RCA equipment does a real job in broadcast stations and why it pays to go "RCA All The Way."

# SOME OF THE STATIONS WHICH HAVE PURCHASED RCA BROADCAST TRANSMITTERS

(U. S. Only)

KARK	KLUF	KVOE	WDAN	WHLD	WMFJ	WSLI
KARM	KMA	KVOS	WDAS	WHLS	WMFR	WSM
KASP	KMED	KVSO	WDBJ	WHUB	WMGA	WSNJ
KBND	KMJ	KWAL	WDEV	WHO	WMJM	WSOO
KBST	KMPC	KWFT	WDGY	WHOM	WMOB	WSPB
KCKN	KMTR	KWLK	WDZ	WIBA	WMOG	WSUI
KDRO	KMYC	KXOK	WEAF	WIBC	WMRN	WSWV
KDYL	KNOW	KXOX	WEBR	WILL	WMRO	WSYB
KECA	KNX	KYA	WEEU	WINX	WMVA	WSYR
KELD	KOB	KYAN	WELI	WIOD	WMWV	WTAG
KELO	KOBH	KYCA	WEMP	WIP	WNBC	WTAM
KFAM	KODL	KYSM	WENR	WIRE	WHBH	WTAQ
KFAR	KOIL	KYUM	WENY	WISN	WNBZ	WTAR
KFBC	KOKO	WACO	WEVD	WIZE	WNOE	WTAX
KFBI	KOMO	WAGA	WEW	WJBK	WOAI	WTHT
KFBK	KOSO	WAJR	WFAA	WJBO	WOC	WTJS
KFDA	KOY	WAKR	WFAM	WJDX	WOI	WTIC
KFEQ	KPAC	WAML	WFBC	WJHL	WOMI	WTMA
KFI	KPDN	WARM	WFBR	WJHP	WOOD	WTMV
KFRO	KPFA	WATL	WFBM	WJIM	WOPI	WTRC
KFWB	KPLT	WATN	WFDF	WJMC	WOR	WTRY
KFPW	KPMC	WAVE	WFIG	WJMS	WORC	WVFW
KFYO	KPPC	WBEN	WFIL	WJPF	WORD	WWL
KFYR	KPRC	WBML	WFLA	WJRD	WPEN	WWNC
KFXM	KRBC	WBNS	WFMJ	WJZ	WPRO	WWNY
KGCX	KRBM	WBNY	WFPG	WKIP	WPID	WWSW
KGER	KRJF	WBOC	WGAC	WKNY	WPTF	WXYZ
KGFI	KRNT	WBRC	WGAN	WKPA	WQAM	W1XG
KGGM	KROC	WBRE	WGAR	WKST	WQBC	W1XOU (WDRC)
KGHL	KROD	WBRY	WGBR	WKY	WRAK	W2XE (CBS)
KGKB	KRSC	WBSP	WGH	WLAV	WRAW	W2XJI (WOR)
KGKO	KSAN	WBT	WGIL	WLAW	WRC	W2XQO (WMCA)
KGLO	KSD	WCAE	WGOV	WLB	WRDH	W3XEY (WFBR)
KGMB	KSO	WCAO	WGPC	WLBJ	WRDO	W3XIR (WCAU)
KGNC	KSRO	WCAR	WGR	WLEU	WRDP	W4XBW (WDOD)
KGW	KTBS	WCAU	WGRC	WLOK	WRDS	W4XFJ (WQAM)
KHAS	KTEM	WCAX	WGST	WLOL	WRDW	W5XAU (WKY)
KHBC	KTOK	WCBI	WGTC	WLS	WREN	W6XDA (KNX)
KHBC	KTRH	WCBM	WHBC	WLW	WRJN	W7XDQ (KOMO)
KHSL	KTRI	WCFL	WHBF	WMAL	WROK	W8XAY (WBEN)
KHUB	KTSM	WCKY	WHBL	WMAM	WRTD	W8XUM (WBNS)
KIEV	KUJ	WCOP	WHBQ	WMAN	WSAM	W8XWJ (WWJ)
KITE	KVCV	WCOS	WHBY	WMBG	WSAV	W9XI (WCFL)
KIUL	KVEC	WCOU	WHEC	WMBO	WSBT	W9XLA (KLZ)
KIUN	KWEW	WCSH	WHIO	WMBS	WSIX	W9XOK (KXOK)
KJR	KVFD	WCED	WHIZ	WMCA	WSJS	W9XPD (KSD)
KLAH	KVOD	WDAK	WHKY	WMEX	WSLB	

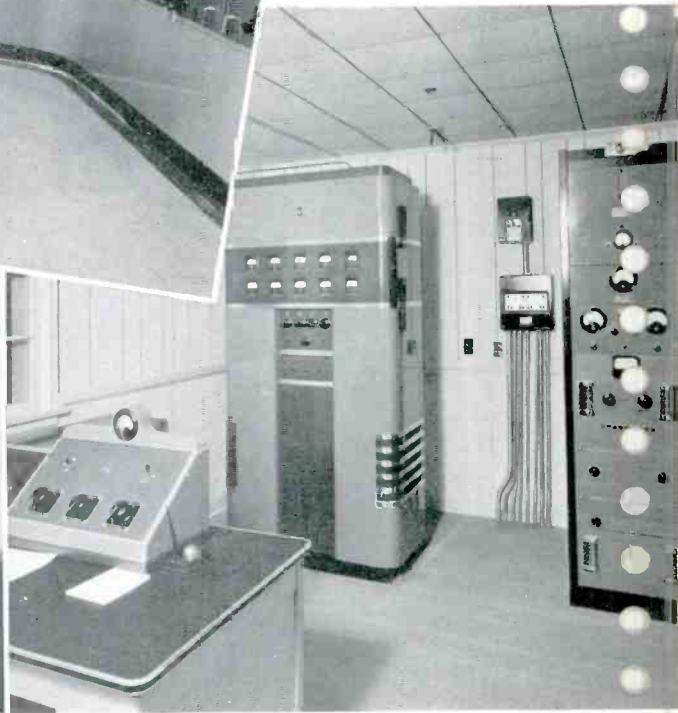
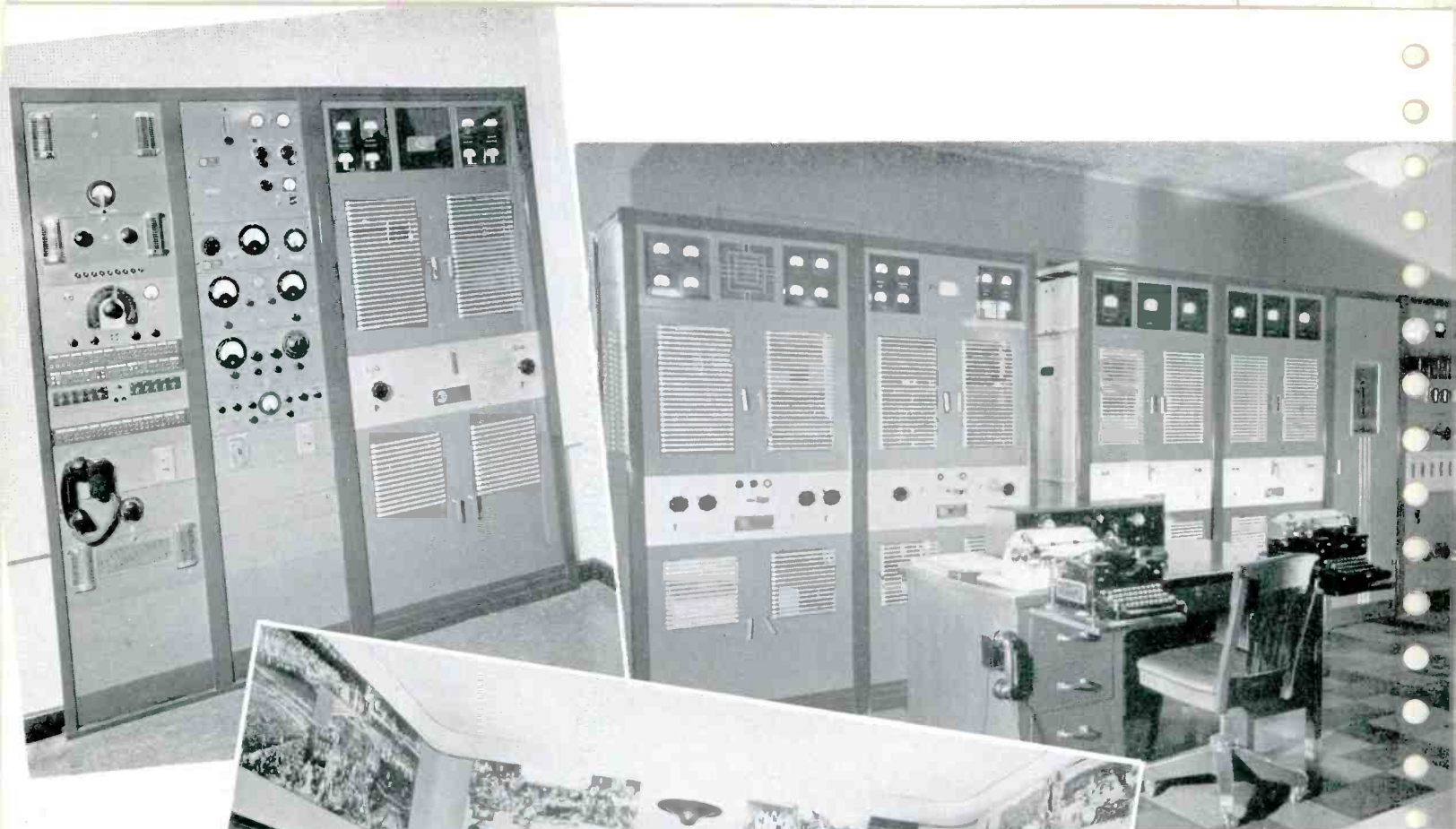

# De Luxe 250-D TRANSMITTER

**T**HE 250-D transmitter is RCA's de luxe 250 watt equipment for progressive stations which want the best and most reliable apparatus. Complete, easy to operate, provided with many automatic features, it is a truly high fidelity transmitter of the first order. In addition it is economical to operate, uses the latest high efficiency tubes and may be supplemented by amplifiers to increase power to 1000, 5000 or 50,000 watts. These are the reasons the 250-D has been chosen by leading stations.

The 250-D uses the simple and efficient high level modulation circuit which is easy to adjust and keep in correct operating condition. It employs a modern tube lineup—RCA-802 oscillator; RCA-802 buffer; RCA-805 intermediate amplifier, and two RCA-805's as power amplifiers. The audio lineup consists of two RCA-843's driving two RCA-845's which drive two RCA-805's as modulators. Complete duplicate crystal oscillators are furnished, each equipped with a low temperature coefficient "V"-cut crystal.

For operating convenience, 16 meters are provided to indicate the conditions of all circuits and facilitate tuning.

A voltage adjustment switch is mounted on the panel to compensate for variations in supply voltage. Output coupling is variable and controlled from the front panel so that full output can be maintained in spite of changes in the antenna characteristics. Crystal units may be switched from the control panel. Power changes between 100 and 250 watts can be made instantaneously by a single switch which automatically adjusts the audio input for the correct modulation level as well as compensating the modulation meter. All tuning is done through dental cables, thus enabling apparatus to be located for most efficient circuit operation. Automatic starting is provided and a built-in dummy antenna is included.

Mechanically, the 250-D represents an important advance by the use of vertical chassis construction. With all apparatus mounted on the vertical surfaces, any piece of equipment can be easily reached for inspection without removing any other part. Other important mechanical features include isolantite or mycalex insulation for radio frequency, circuit breakers instead of fuses, all tubes accessible through front doors, Pyranol condensers, standard rust-proofed steel panels and sturdy, welded frame.

The transmitter is attractively finished in two tones of gray and

satin chrome. The cabinet is highly polished and waxed to make it easy to keep clean and shining. Interior surfaces are finished in opalescent lacquer. The 250-D comes completely assembled, too. Only a few small items need be mounted when the transmitter is unpacked in order to set it up ready for connection.

For performance, it is difficult to match the 250-D. Harmonic distortion is below 3% over the audio band from 50 to 7500 cycles. Frequency response is flat within 1 db. and hum level is below minus 60 db. The high efficiency output circuit guarantees full rated power in the antenna. Power consumption is only 1.7 kw. Replacement tube cost has been reduced to the minimum by low priced, long life tubes. Thus the 250-D is a transmitter properly designed, carefully engineered, tested and retested, which will offer a long and useful life to the purchaser.

## SPECIFICATIONS

Fully approved for use by the Federal Communications Commission.

Rated Operating Power:	
100-H Transmitter**	100 watts
250-D Transmitter	250 or 100/250 watts
Radio Frequency Range	550 to 1600 kes.
Radio Frequency Stability	±10 cycles
Radio Frequency Harmonics below	.05%
Modulation Capability	100%
Audio Input for 100% Modulation	+5 VU (—6 db. *)
Audio Input Average Program Level	—1 VU (—12 db. *)
Audio Frequency Response (±1 db.)	30 to 10,000 cycles
Audio Distortion (50 to 7500 cycles) max.	3% RMS
Background Noise and Hum Level (unweighted)	—60 db.
Power Supply	110/220 volts, 50/60 cycles
Power Consumption (average program):	
100-H Transmitter	1400 watts
250-D Transmitter	1700 watts
Dimensions (overall)	38¾" x 25¼" x 84⅛"
Weight	1400 lbs.
Weight (packed)	2000 lbs.
Tubes for 100 watt operation:**	3-802‡, 3-838, 2-843, 4-845, 6-866-A, 1-5Z3.
Tubes for 250 watt operation:**	3-802‡, 3-805, 2-843, 2-845, 2-805, 6-866-A, 1-5Z3.

‡ Including spare oscillator.

\* Zero db. equals 12½ milliwatts.

\*\* When used for 100 watts only, the 250-D is designated as the 100-H.

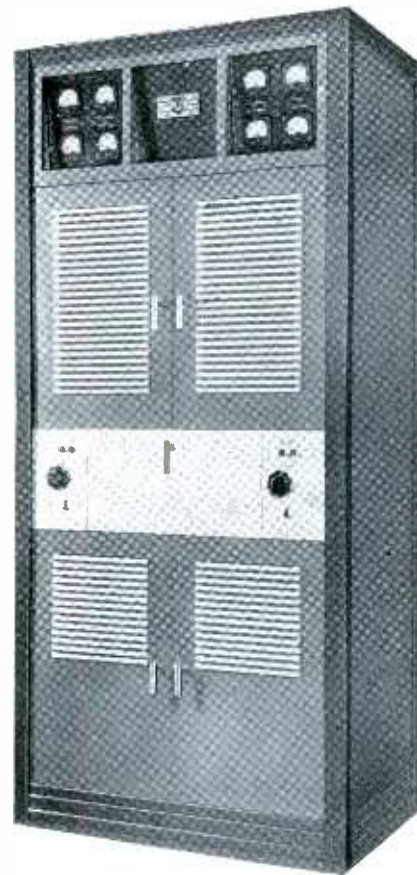

*De Luxe*

## Type 250-K Transmitter

(a) 100 watts, (b) 250 watts or (c) 100/250 watts

*An outstanding, high fidelity Transmitter having excellent performance, accessibility and unusually pleasing appearance.*

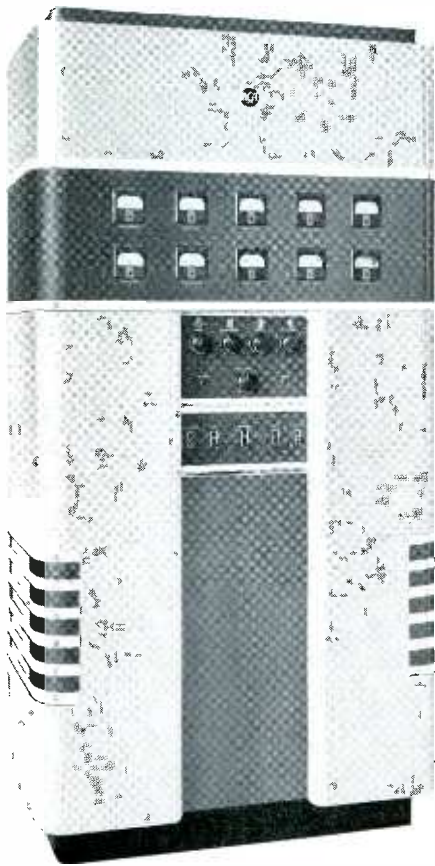

**T**HE TYPE 250-K Transmitter has been designed to provide a low power transmitter of modern construction and unusually attractive appearance. It meets all the requirements, including good engineering practices, as specified by the Federal Communications Commission. It is a complete self-contained unit, simple and efficient in operation requiring only connections to the power supply, audio input, antenna and auxiliary equipment. The outstanding features are simplicity, performance, accessibility (vertical chassis

construction) and attractive appearance.

Using the same set of tubes, this transmitter will operate at (a) 100 watts, (b) 250 watts and (c) 100/250 watts, utilizing the highly efficient and well-known high level Class "B" modulating system resulting in unusual economies in operation, because a minimum number of inexpensive number of tubes insures low maintenance cost. The tube complement for power outputs (a), (b) and (c) are: oscillator 1-802, buffer 1-828, power amplifier, 2-810, first A-F amplifier, 2-1620, modulator 2-828, rectifier 2-872 and bias rectifier 1-80. Two of the famous RCA "V"-cut Quartz Crystals mounted in the RCA Type TMV-129-B Holders are provided. These crystals are of the low temperature coefficient type, ground to "zero beat." Also, a crystal socket is supplied in the transmitter in which the spare crystal may be maintained at the correct operating temperature.

A total of ten meters are provided to indicate the conditions of all major circuits and to facilitate tuning. These

meters are mounted at eye-level. The transmitter uses the new flat vertical type of chassis construction which provides unusual mechanical rigidity, accessibility and ventilation. The equipment is mounted in such a manner that each item may be easily removed by one man in the shortest possible time. The variable elements are placed where they will perform with the utmost simplicity. Controls are grouped on a single panel, conveniently placed, and connected to the variable inductors by means of beveled gears and extension shafts. Indicators, are provided so that the position of each control may be accurately logged.

The 250-K is housed in an unusually attractive cabinet. The control panel is photo-etched and is indirectly illuminated. The color of the transmitter is two-tone umber gray, hand-rubbed and waxed, and the trim-strips are of brushed-chrome.

High fidelity is materially aided by the employment of approximately 20 db. of audio feed-back over the entire audio system. The audio circuit is designed in such a manner that the system is inherently stable.

Power change is accomplished by means of a switch on the control panel of the transmitter. This switch is a part of the transmitter and is wired to terminals on a terminal board. When power change is desired, the MI-7244A power change equipment consisting of a relay, a capacitor, and three resistors are supplied. When the transmitter is operated as a 100-watt transmitter, only the capacitor and the resistors are employed. The control circuits are considerably simplified as compared to previous equipments and, at the same time, they offer adequate protection to the transmitter and operating personnel. One of the very unusual features of this transmitter is a relay which eliminates the necessity of recycling of the time delay relay when power failures or interruption occur which do not exceed a period of three seconds. Overall protection is provided by the use of magnetic circuit breakers—also serving as switches. No fuses are used in any power circuits.

The transmitter employs only one high-voltage rectifier to supply plate potentials for all tubes. Two RCA-872 rectifier tubes, which are known to have long life and excellent performance, are used. Bias voltage for the modulator tubes is supplied from an RCA-80 rectifier tube.

No variable capacitors are used in any of the R-F circuits. Continuously variable coils are used as tuning elements throughout, eliminating the possibility of flash-overs which may occur in variable capacitors. Resonance neu-

tralizing is employed in the Class "C" output stage.

A matching network is provided between the output tank circuit and the output terminals of the transmitter, which includes series inductive elements and shunt capacitances. As a result, very complete radio frequency harmonic attenuation is secured. Output terminals are provided at the top of the cabinet for connecting to the open 4-wire transmission line or an antenna lead-in, and facilities are provided for bringing in a concentric transmission line through the base of the transmitter, if required.

## SPECIFICATIONS

### Rated Operating Power:

- (a) 100 watts (\*)
- (b) 250 watts
- (c) 100/250 watts (\*)

Radio Frequency Range.....550 to 1600 kes.

Radio Frequency Stability.....±10 cycles

Radio Frequency Harmonics Below......05%

### Monitoring facilities provided for:

- (a) Modulation Indicator
- (b) R-F Monitor
- (c) Audio frequency Monitor

Modulation Capability.....100%

Type of Modulation.....High Level Class "B"

Carrier Shift.....Less than 5% from zero to 100% modulation,

50 to 7,500 cycles

Audio Input for 100% Modulation.....+16 VU (+5 db.\*\*)

Audio Input Average Program Level.....+10 VU (-1 db.\*\*)

Power Supply.....105 to 115 volts, 50/60 cycles,

single phase, with line regulation not to exceed +5%

### Power Consumption (Average Program):

(a) at 100 watts: power input is 1500 watts

(b) at 250 watts: power input is 1625 watts

Audio Frequency Response (+1.5 db).....30 to 10,000 cycles

Audio Distortion (50 to 7,500 cycles) less than......3% RMS

Background Noise and Hum Level (unweighted).....-60 db.

Dimensions (overall).....height 84 $\frac{1}{8}$  inches, width 40 $\frac{1}{2}$  inches,

and depth 21 $\frac{1}{16}$  inches

Weight (unpacked).....1360 lbs.

Weight (packed).....1635 lbs.

Tubes for (a) watts, (b) 250 watts, or (c) 100/250 watts

1-802, 2-810, 2-1620, 3-828, 2-872, 1-80

(\*) Power change equipment MI-7244A required.

(\*\*) At a reference level of 12.5 mw. across 500 ohms.

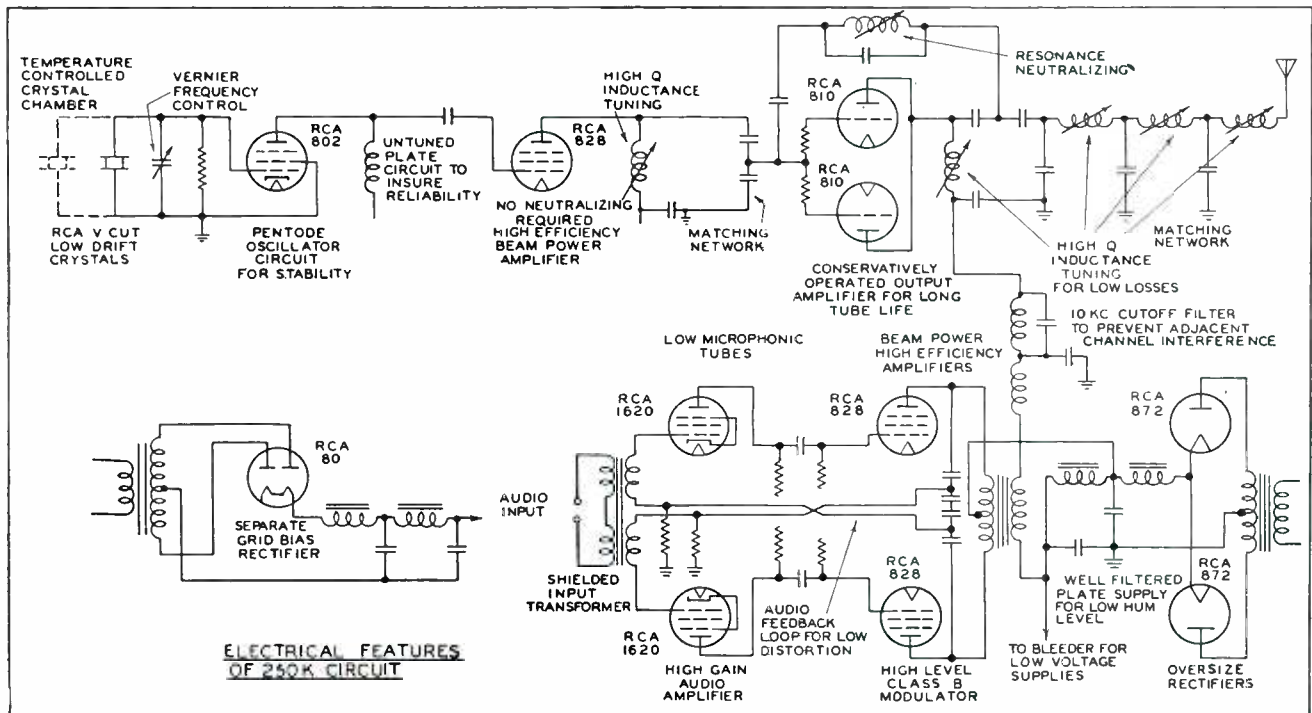
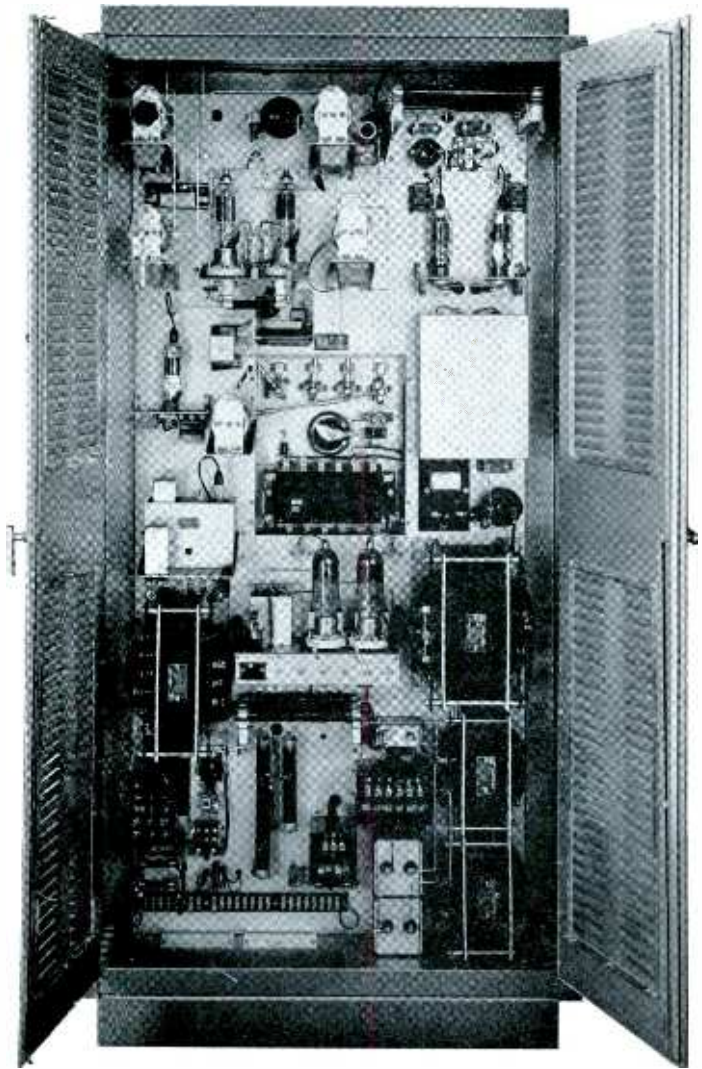

*De Luxe*  
**1000 Watt Transmitter**  
**Type I-K**

*A I-KW Transmitting Equipment of Modern Design*



**T**HE I-K (MI-7186) Broadcast Transmitter Equipment has been designed to provide a 1000 watt transmitter of modern construction and unusually attractive appearance and also to provide an amplifier (MI-7187) for the type 250-K Broadcast Transmitter where it is desired to increase the power output to 1000 watts. The amplifier consists of a cabinet which matches the 250-K cabinet and a center section which contains the heavier power equipment. The outstanding features of this new transmitter are simplicity, performance, accessibility and appearance. The I-K transmitter operates at: 1000 watts, 500 watts, 500/1000 watts, 250/1000 watts, and 250/500 watts. The tube complement is the same for all power outputs.

The I-K transmitter contains all of the necessary capacitors and inductors for operation at any frequency between 550 and 1600 KC. The highly efficient high level Class "B" modulation system is employed. Audio frequency response is uniform within  $\pm 1.5$  DB from 30 to 10,000 cycles at any percentage of modulation and the audio frequency distortion is less than 3% RMS at any frequency between 50 and 7500 cycles for any degree of modulation between 0 and 95%.

An audio input of approximately plus 16 vu. (plus 5 db. at a reference level of 12.5 mw. across 500 ohms) level is required for 100% modulation. The audio input for average program level is

approximately plus 10 vu. (minus 1 db. at a reference level of 12.5 mw. across 500 ohms).

The carrier frequency of this new broadcast transmitter is maintained well within the new requirements of FCC, of plus or minus 20 cycles of the assigned carrier frequency, by means of the famous RCA "V"-cut low temperature coefficient quartz crystals and associated circuits. A vernier condenser is provided in the crystal oscillator circuit to adjust the crystal frequency to exact zero beat. A spare crystal mounted in the type TMV-129-B holder is supplied with the equipment. A crystal socket is supplied in the transmitter in which the spare crystal may be maintained at the correct operating temperature.

The control circuits are considerably simplified as compared to previous equipments, and at the same time they offer adequate protection to the transmitter and operating personnel. One of the unusual features of this transmitter is a relay which eliminates the necessity of recycling of the time delay relay when power failures or interruptions occur which do not exceed a period of four seconds. Overload protection is provided by the use of magnetic circuit breakers, also serving as switches. These switches have been used by RCA in other transmitters with excellent results for the past few years.

The transmitter is designed for operation from a 210 to 240 volt 50/60 cycle, single phase supply with line regulation not to exceed  $\pm 5\%$ . A variable transformer adjustable from the control panel provides a means of maintaining the proper voltages as required in the transmitter over this line voltage range. A power supply of 110 volts 50 or 60 cycles is required for the crystal heaters.

The transmitter will deliver rated power into a 70 to 600 ohm transmission line or into any type of antenna normally used by broadcast stations. A matching network is provided between the output tank circuit and the output terminals of the transmitter which includes series inductive elements and shunt capacitances. As a result, very complete radio frequency harmonic attenuation is secured. Output terminals are provided at the top of the cabinet for connection to an open 4-wire transmission line or antenna lead-in. Facilities are provided for bringing in a concentric transmission line through the base of the transmitter, when such a line is used.

Where this transmitter is to be coupled to either (a) a concentric line or (b) an open 4-wire line, the RCA Type AZ-4293 (MI-7423) Antenna Tuner



may be used. In this case, a remote metering kit, MI-19404, is supplied in place of the RF Ammeter in the transmitter. This equipment is furnished at a slight additional cost.

A total of twenty meters is provided for observing the performance of all important electrical circuits. These meters are placed at eye level, for convenience in reading.

The use of high level Class "B" modulation results in unusual economies in operation. A minimum number of inexpensive tubes insures low maintenance cost.

Terminals are provided for: (a) Modulation indication: A Pick-up coil coupled to the tank coil of the output stage; (b) RF Monitoring: By means of voltage developed across a capacitor in the ground side of the buffer stage; (c) Audio frequency monitoring: By means of a voltage developed across a resistor connected in series with the secondary of the modulation transformer. A level of approximately 10 + vu. is available at this point at 100% modulation.

The I-K equipment is normally supplied for operation at 1000 watts output. Where power change is required for two power outputs, a kit of power change equipment (MI-7188) is required. This equipment is easily installed on the chassis in the center section of the equipment.

The power change equipment consists essentially of resistance (which is connected in the power supply of the final amplifier) and a contactor for short circuiting the resistance. The contactor is operated by a toggle switch which is located on the control panel of the 250-K exciter. This equipment will reduce the power output from 1000 to 500 or 250 watts or from 500 to 250 watts as required. When the transmitter is operated at 500 or 500/250 watts the plate voltage of the final

amplifier is reduced by means of a low voltage tap on the plate transformer of the high voltage rectifier.

The highly accessible type of RCA flat vertical chassis construction which provides unusual mechanical rigidity, accessibility and ventilation, is used in mounting the equipment. The equipment is mounted in such a manner that every item may be easily removed by one man in the shortest possible time. The variable elements are placed where they will perform with the utmost efficiency. Controls for each unit are grouped on a single panel conveniently placed on each of the two cabinets, and connected to the variable inductors by means of beveled gears and extension trunks. Indicators, consisting of revolution counters, readable from the front of the transmitter, are provided so that the position of each control may be accurately logged.

## SPECIFICATIONS

Electrical Characteristics:— Frequency Range: 550 to 1600 Kc. Frequency Stability: +10 cycles. Power Output: 1000, 500, 500/1000, 250/1000, 250/500 watts. Power Input: Average program level, 1000 watts output (approx.) 4800 watts 100% modulation, 1000 watts output (approx.) 5700 watts. Average program level, 500 watts output (approx.) 4000 watts 100% modulation, 500 watts output (approx.) 4500 watts. Average program level, 250 watts (output) 3600 watts 100% modulation, 250 watt (approx.) 3800 watts. Power Supply: 210 to 240 volts, 50/60 cycle, single phase, with line regulation not to exceed  $\pm 5\%$ . Type of Modulation: High level, Class "B". Carrier Shift: Less than 5% from 0 to 100% modulation, 50 to 7500 cycles. A. F. Input Level: At 100% modulation +16 VU (approx.). At average program level +10 VU (approx.). A. F. Performance: Within +1.5 db from 30 to 10,000 cycles. A. F. Distortion: Less than 3% rms from 50 to 7500 cycles. Noise Level: 60 db below 100% modulation. R. F. Harmonics: Less than 0.05%. Tube Complement: Type 250-K Exciter (MI-7243A) 1 RCA-802, 1 RCA-828, 1 RCA-810, 2 RCA-1620, 2 RCA-828, 2 RCA-872, 1 RCA-80. Type 250-K Exciter (MI-7243) 1 RCA-802, 1 RCA-814, 1 RCA-810, 2 RCA-1620, 2 RCA-828, 2 RCA-872, 1 RCA-80. Type I-K Amplifier 2 RCA-833, 2 RCA-833, 4 RCA-872, 2 RCA-866.

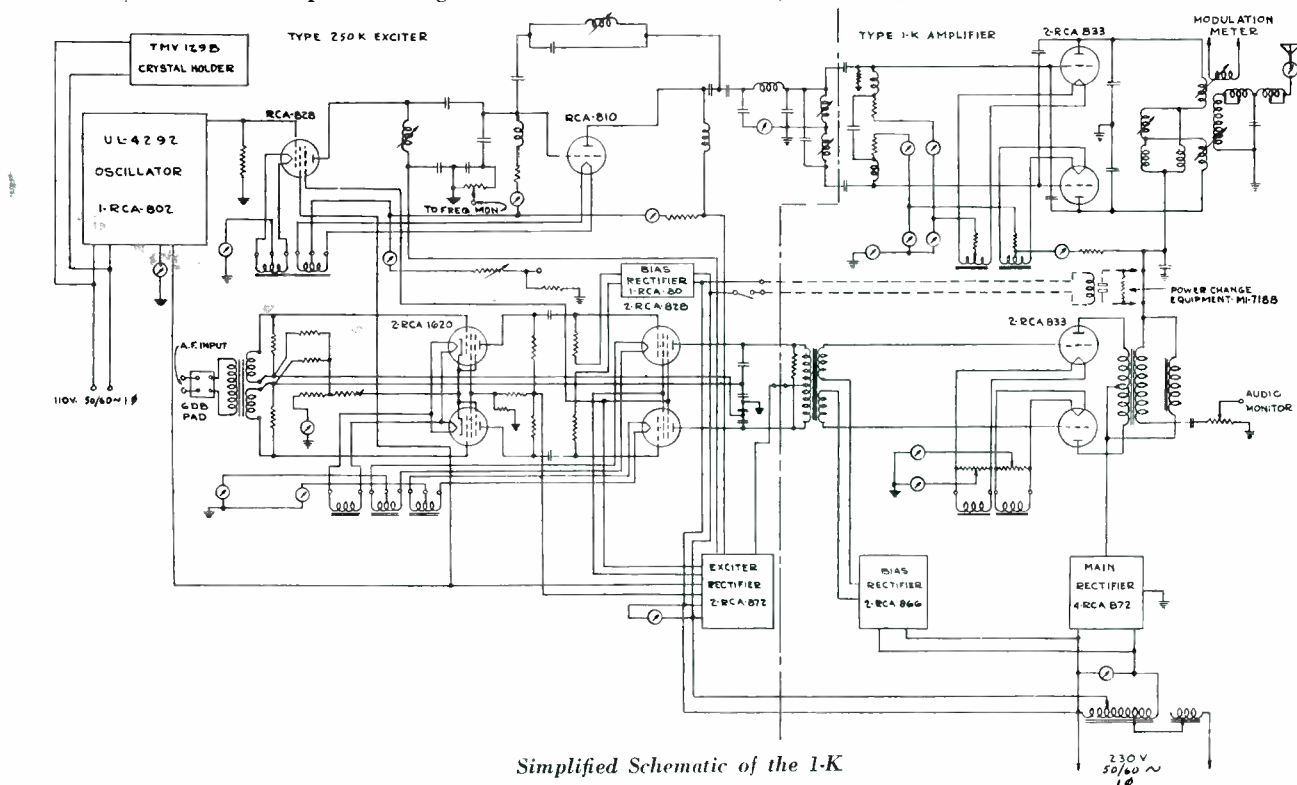

Simplified Schematic of the I-K

*De Luxe*  
**5000 Watt Transmitter**  
**Type 5-DX**

*A De Luxe Transmitting Equipment with "Unified-Front"*  
*Type Construction and Master Control Console*

**F**OR those applications where an unusually impressive appearance is of advantage, RCA engineers, working in close collaboration with the RCA styling department, have designed a transmitting equipment which combines unapproached beauty and symmetry with the last word in operating convenience. Basically this new Type 5-DX Transmitter is identical with the Type 5-D Transmitter which has been described in detail in the preceding pages. Behind the front panel the four units of this new transmitter—i. e. exciter, power amplifier, modulator-rectifier and power-control,—are the same as those of the 5-D Transmitter. However, in the 5-DX Transmitter the whole assembly has been furnished with an overall "unified"—front panel of truly superb attractiveness.

Looking at the front view of this transmitter, as shown, an idea of the beautifully streamlined installation it makes

possible is gained. But even so it fails to do this new equipment entire justice. Actually, when installed flush with the wall of the operating room and with indirect lights in the valance above, the impression is one of a transmitter such as would be associated in the average expectancy with installations of five or ten years hence. As can be seen the three operating units are centered and provided with full-width doors having wide, heavy grills. The power control unit (on the right) has a full-length non-interlocked door providing immediate access to relays, auxiliary controls, etc. On the extreme left is a door (interlocked) which provides access to the interior of the transmitter compartment. All doors, and the fixed parts of the "unified" front, are of  $\frac{1}{8}$ " steel plate—this weight insuring that these will not "flex" or give. In fact the whole construction is especially sturdy and in keeping with the idea of an equipment in which nothing has been spared to

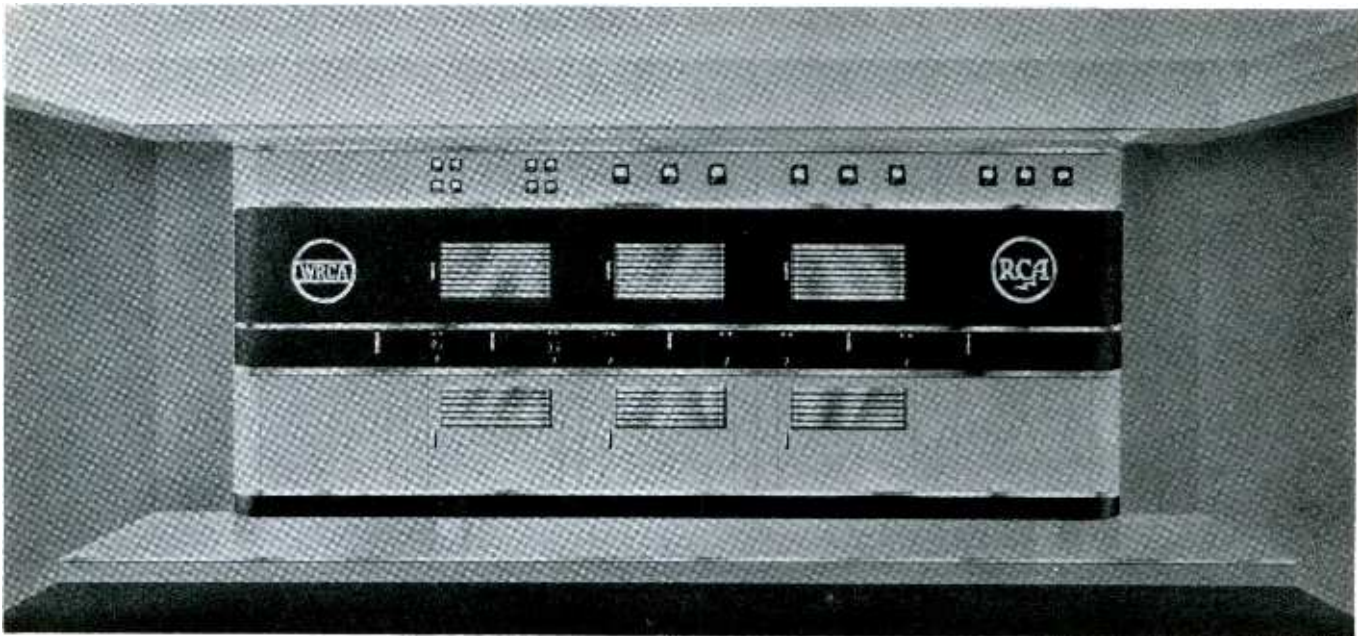

# 5-DX Transmitter

provide the best. More on the utilitarian angle is the adaptability to air-conditioning. This may be carried out by exhausting air from behind the transmitter, thus drawing cool air from the operating room through the transmitter doors and out. Or, if desired, glass may easily be fitted behind the six grilled sub-doors, thus isolating the transmitter from the operating room and allowing each to be ventilated and cooled separately.

The second unusual feature of the 5-DX equipment is the operating console which is furnished with this transmitter as standard equipment. On this console are grouped all of the essential transmitter controls plus audio input switching and monitoring controls. Mixers are provided for a local announce microphone, a local turntable and the studio line. A push button selector switch permits the input to the monitoring amplifier to be instantly bridged across either of the two incoming lines, the turntable, the transmitter input or the transmitter output.

A standard VU meter is furnished and it may be instantly switched across the incoming lines or the transmitter input by means of a push button switch. Cut outs are provided for conveniently installing four additional meters. These additional meters may be extensions from the antenna ammeter, the line ammeter, the modulation monitor meter, the frequency monitor meter, or the limiting amplifier meter as desired. And with all these circuits are signal lights, indicating at a glance the operation of the whole transmitter installation. Completely assembled, wired and tested at the factory this console saves much installation time, provides optimum performance and insures maximum convenience—plus the fact that it is a “matching” unit which adds to the beauty and distinctiveness of this unique transmitting equipment.

A constant increase in output power has, over the years, been a definite feature of broadcast progress—and hence the feasibility of future power increases is always worth considering. To be practical the economics involved in making such a change should be considered. For instance, an increase from 5,000 watts to 10,000 watts might not be justified if the expense involved were very large. But if this expense were relatively small it might be—and some

stations have found it to be—very much worth while. The 5-DX provides for this situation as does no other transmitter. It is easily—and inexpensively—changed over for 10,000-watt operation by adding a very simple unit housing an additional amplifier tube. Only very minor changes in the existing installation are required. The converted transmitter is efficient, reliable and has quality equal to that of the original. Moreover, this does not make the installation an orphan, or a hybrid, for with this change the 5-DX becomes a 10-DX Transmitter—a standard unit which is registered with the FCC as such, and which is sold complete wherever a 10-kw. Transmitter is originally required.

## SPECIFICATIONS

### ELECTRICAL SPECIFICATIONS

Carrier Power Output: 5,000 or 5,000/1,000 watts. Carrier Frequency Range: 550-1,600 kc. Carrier Frequency Stability: Within  $\pm 10$  cycles. Modulation Capability: 100%. Audio Distortion: Less than 3% r. m. s. 0-95% modulation, 50—7,500 cycles. Audio Frequency Response: Uniform within  $\pm 1\frac{1}{2}$  db. 30—10,000 cycles. Carrier and Hum Level: Better than 60 db. below 100% modulation, unweighted. Power Input: 5 kw., 14.1 kw. without modulation, 15 kw. with average modulation; 1 kw., 10 kw. without modulation, 10.5 kw. with average modulation. Power factor approximately 90%, 230 volts, 3 phase, 60 cycles. Antenna and Line: For use with concentric or grounded 4-wire transmission lines of 70-300 ohms impedance and with standard antennas. Audio Input Level: Zero level (12.5 m. w.) at 500 ohms for 100% modulation. Tubes (one set): 5-DX Transmitter 3-802, 3-805, 8-866-A, 2-891-R, 1-892-R, 6-872-A, 1-5-Z-3, 2-1603, 2-807, 4-845, 1-83-V; 5-DX Control Console 1-1603, 4-76, 2-6L6G, 1-5Z3, 1-6A6, 2-84.

### MECHANICAL SPECIFICATIONS

Transmitter Unit: 115" wide x  $84\frac{1}{8}$ " high x 27" deep. Weight: 4,170 lbs. Power Panel: 33" wide x  $84\frac{1}{8}$ " high x 36" deep. Weight: 850 lbs. Filter Rack: 33" wide x  $49\frac{1}{2}$ " high x 26" deep. Weight: 1,375 lbs. Modulation Transformer and Reactor Unit: 68" wide x 28" high x 24" deep. Weight: 2,100 lbs. Plate Transformer: 39" wide x 24" deep x 46" high. Weight: 990 lbs. Antenna Coupling Unit: 30" wide x 40" high x  $22\frac{1}{2}$ " deep.

# TRANSMITTER CONTROL DESK

MI-11616



**T**HE MI-11616 Transmitter Control Desk has been designed primarily for use with the RCA 5-D and 5-DX Broadcast Transmitters, but its versatility and attractive appearance will make it a desirable addition to any transmitter installation. As shown in the accompanying diagram, the MI-11616 Desk contains all the mixing and switching facilities required at the transmitter plant. It is equipped with a standardized vu meter, and extension modulation monitor and antenna current meters. Cutouts are provided for two additional meters such as an extension db. compression meter for the limiting amplifier and an extension meter for the frequency monitor.

Mechanically interlocked push-keys permit instant selection of the circuit to be monitored by the vu meter or by the monitoring amplifier. By means of the push-keys, the monitoring speaker may be used to check the (1) transmitter audio input, (2) transmitter audio output, (3 and 4) two incoming lines and (5) turntable output. Balanced, high quality, step-by-step mixers are provided for the (1) incoming line, (2) announce microphone and (3) turntable. Master or transmitter input control and a monitor amplifier volume control are also furnished. Key switches in the outputs of the microphone and turntable mixers are equipped with indicating lamps. The microphone key is interlocked with the monitoring speaker through a relay and disconnects the speaker whenever the microphone is on. A line transfer lever key permits ready

selection of either of two incoming lines and transfers the telephone set to the line not being used for the program. A three-position key switch selects the studio line or the local microphone and turntable. Chromium plated guards prevent accidental operation of the important keys. A spare D.P.D.T. lever key is furnished for the convenience of the station personnel.

The desk is equipped with a 12 volt, 1 ampere, DC power supply which furnishes power to the speaker interlocking relay and to the audio circuit indicating lamps. The power supply utilizes a copper sulphide, dry rectifier and capacity filter.

The transmitter power switches are mounted on the left hand control panel and are designed for 220 volt operation. Associated lamps are furnished and may be arranged for operation from 110 or 220 volts. Switches and lamps are provided for (1) transmitter filaments, (2) transmitter plate, (3) overload reset, (4) transmitter high-low power transfer, (5) tower lights, (6) audio equipment and (7) spare.

The desk and turret are constructed of metal throughout. The left-hand pedestal contains a typewriter shelf and the right pedestal contains two convenient drawers. A third drawer is located in the center between the pedestals. Skids have been provided below the pedestals to conceal the wiring conduits. All wiring is carried inside the desk. The desk top is covered with black linoleum with rounded corners and chromium trim. The turret panels hinge forward for easy servicing and the entire rear cover of the turret may be removed to facilitate installation or basic changes. The desk is finished in two tones of umber gray, but other finishes are available on special order.

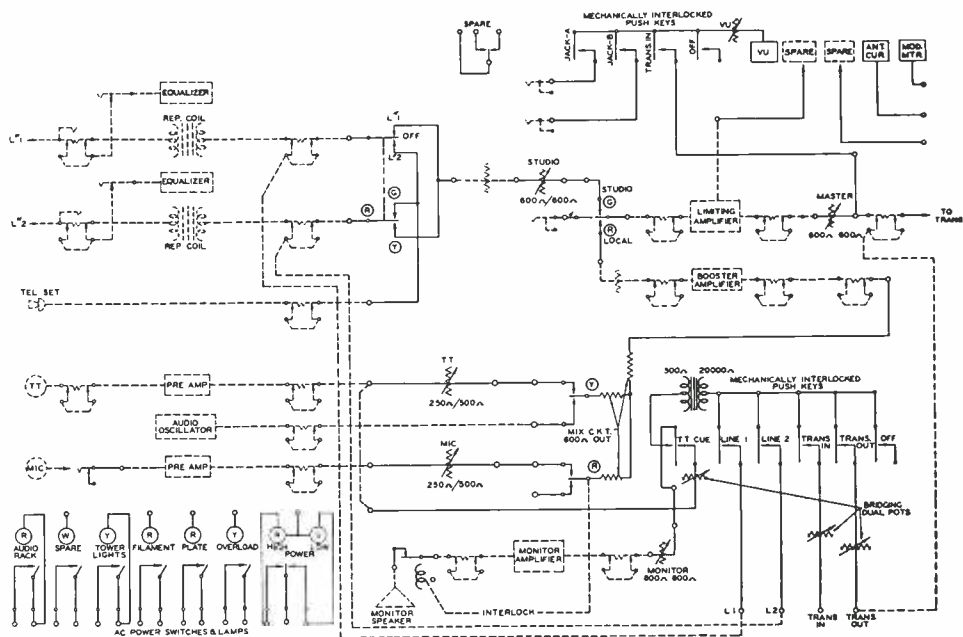

*De Luxe*  
**10,000 Watt Transmitter**  
**Type 10-DX**

**A 10 KW Transmitting Equipment with "Unified Front Construction"**

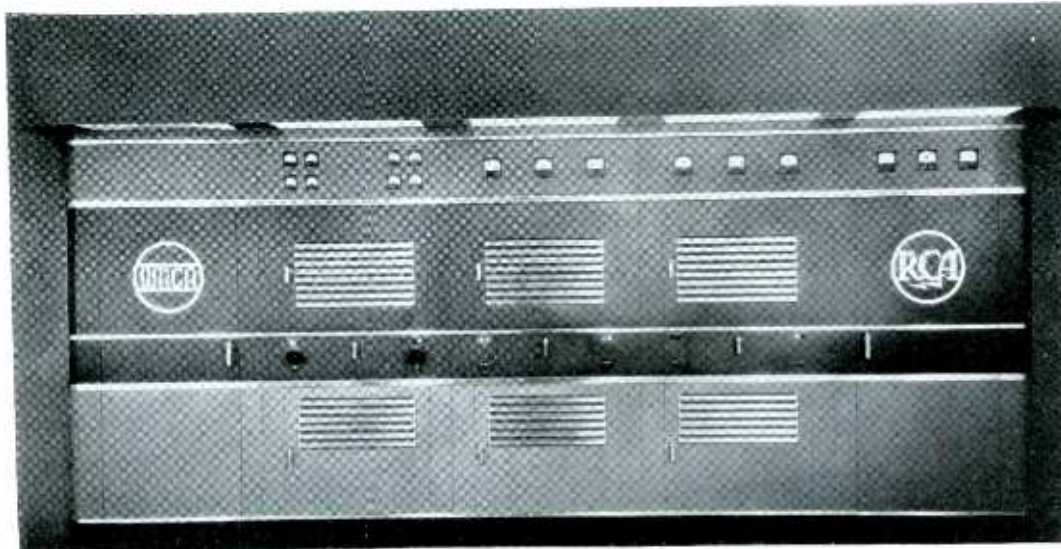

AS in the case of the 5-D and 5-DX transmitters the electrical specifications and performance of the 10-D and 10-DX are identical, but the appearance of the two 10 KW equipments is similar to their 5 KW prototypes. The 10-D and 10-DX are exactly the same as the 5-D and 5-DX respectively, in so far as front of panel appearance is concerned, however, an additional compartment is added directly to the rear of the power amplifier cabinet, housing a second RCA-892R radio frequency amplifier tube with its associated blower and protective equipment. The depth of the radio-frequency amplifier is approximately doubled by the addition of the second amplifier tube, otherwise dimensions are the same as those of the 5-DX.

The Type 10-D and 10-DX transmitters are characterized by the same high quality of performance as the 5-D. The conditions of operation of the tubes are the same, permitting similar performance and the same long tube life which experience has proved to be attained in the 5-D transmitter. The fidelity of transmission of the Type 10-D and 10-DX transmitters is exceptional. The same high level modulation system used in the 5-D is incorporated into these equipments. It features high efficiency, and a unique feed-back circuit which is extremely stable, and unaffected by adjustments of the radio frequency circuits.

In designing the 10-D transmitter RCA engineers have used all their skill, as well as the vast facilities of the RCA organization. The result is a transmitter first in all the factors which weigh with the broadcast station engineer and management. Fidelity, distortion, and noise level are

held to standards beyond any demands which may result from requirements of higher fidelity service for many years. Economy is assured by the use of extremely long life tubes, and the highly efficient high level system of modulation. The cost of operation of this equipment per hour has been shown to be considerably less than that of many 5 KW installations. Reliability is guaranteed, as in all RCA transmitters, by the use of simple, easily adjustable, easily checked circuits, the selection of the best parts and materials, and rigorous control of quality, implemented by an inspection system which checks every component from the raw material to the finished apparatus. Because of the complete separation of audio and radio frequency circuits in this type of equipment until they meet in the plate circuit of the output amplifier, it is possible to control performance very closely by design. This means that field adjustments are few and simple.

### SPECIFICATIONS

Carrier Power Output: 1000 watts. Frequency Range: 550-1600 kc. Carrier Frequency Stability: Within  $\pm 10$  cycles. Modulation Capability: 100%. Audio Distortion: Less than 3% RMS, 0-95% modulation, 50-7500 cycles. Audio Frequency Response: Uniform within  $\pm 1.5$  db., 30 to 10,000 cycles. Carrier and Hum Level: Better than 60 db. below 100% modulation, unweighted. Power Input: 25 KW average program modulation. Power Factor: Approximately 90%. Power Supply: 230 volts, 3-phase, 60 cycles. Antenna and Line: Concentric or grounded 4-wire transmission lines, 70-300 ohms impedance, and with standard antennas. Audio Input Level: +10 VU for 100% tone modulation. Tubes (one set): 3-RCA-802, 3-RCA-805, 8-RCA-866A, 2-RCA-891R, 2-RCA-892R, 6-RCA-872A, 1-RCA-5Z3, 2-RCA-1603, 2-RCA-807, 4-RCA-845, 1-RCA-83V, Control Console: (10-DX only) 1-RCA-1603, 4-RCA-76, 2-RCA-6L6G, 1-RCA-5Z3, 1-RCA-6A6, 2-RCA-84. Mechanical Limits: Dimensions, front panel: 14'-6 7/8" long x 7'-1/8" high. Total Weight: 10,800 lbs.

# De Luxe 50,000 WATT TRANSMITTER

TYPE 50-E . . . A De Luxe High Fidelity Transmitting Equipment for Clear Channel Stations

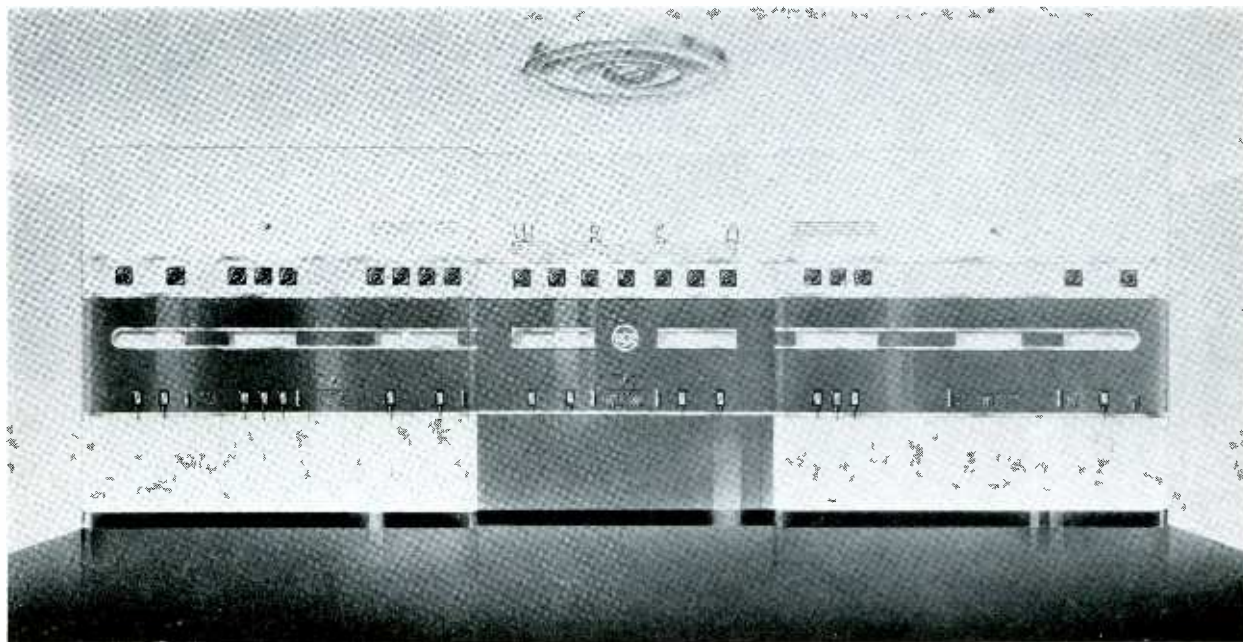

**T**HE RCA 50-E Broadcast Transmitter is the latest high power equipment design of an organization devoted to the manufacture of radio apparatus and specializing in broadcast transmitters.

It is a Class "B" high level modulated, air-cooled transmitter containing many features that contribute toward its ease of operation and installation, together with trouble free performance.

Power economy is, of course, one of the most important factors in determining the choice of a transmitter. The 50-E transmitter employs the high level, Class B modulation system developed by RCA, to obtain the greatest overall efficiency on any transmitter circuit in general use today.

The 50-E transmitter will cost less to install and to operate. The space requirements are unusually small.

Since the 50-E is completely air-cooled, an installation saving is effected by the absence of water cooler, tank, pumps and interconnecting copper pipe. The costs of installing a 50 KW water cooling system are quite appreciable and these charges are reduced in an equivalent air cooling system.

The 50-E transmitter reduces installation costs through the elimination of a number of trenches in the concrete floor between transmitter units. The 50-E is provided with

built-in wire ducts which form an integral part of the transmitter.

Tube cost is another item which has an important bearing on the bills for running a broadcasting station. The use of high level, Class B modulation itself has a desirable effect on length of life of the high power tubes.

Every precaution has been taken with the 50-E transmitter to assure continuous service, free from breaks or interruptions to program transmission.

The transmitter is equipped with an additional modulator and rectifier unit for the exciter so that this portion of the system is capable of operation as a complete self-contained 5 KW transmitter. While ordinarily the exciter is not required to furnish a full 5 KW driving power, 5 KW tubes are employed in order to provide conservative loading and to obtain longer life. Full 5 KW output is possible without fundamental changes in the circuit. Hence, it will not be necessary to employ a separate stand-by transmitter and thus less capital expense is tied up and less room is required in the transmitter building.

High reactance type filament transformers are employed to limit the starting current on the high power filaments when they are first lighted. This tends to prolong tube life by greatly reducing stresses on the filament and it also eliminates a number of starting contactors formerly employed.

Component parts are operated well below their rating.

The transmitter is equipped with direct indicating circuit breakers rather than fuses so that location of faults is easy and rapid.

The transmitter employs rigidly tested pressure type condensers in the high power tank circuits. If the standard antenna tuning unit is employed, the tuning capacitor is an atmospheric pressure air type condenser which is less subject to failure or to breakdown due to static discharges during the summer.

The 50-E transmitter is provided with a unified front panel and, since RCA first originated this method of construction, it has met with wide acceptance among the users of equipment. The front panel presents a more pleasing appearance for the transmitter and at the same time provides for a "cleaner" mechanical design and mounting of equipment. The arrangement of the 50-E transmitter enables the equipment to be mounted in the "straight line" panel design or in the shape of a "U" and in several other forms without extra cost, to conform to the building layout.

The vertical type of chassis construction which has proved so successful in the RCA 5-D transmitter is also employed in the exciter unit of the 50-E. In this method of construction all parts are easily reached and equipment is mounted directly on vertical surfaces without the use of shelves.

A unique feature of the 50-E transmitter is the use of electrical tuning for the RF power amplifier and exciter stages. This method of tuning permits adjustment of circuits by means of push buttons located on the front panel of the transmitter. Hence the components may be located for the optimum position from a circuit standpoint without introducing complicated and cumbersome mechanical controls.

A number of other features of convenience have been provided in the 50-E transmitter including large 6" anti-parallax indicating instruments with black faces and large, easily read white scale and pointer. The 50-E is also equipped with a polyphase wattmeter for indicating total power consumption.

The 50-E transmitter has been designed to produce unusually high fidelity performance. It is possible to produce higher fidelity transmission in the high level modulation type of circuit used in the 50-E and full advantage has been taken of this point in the electrical design.

In addition, the high level type of modulation is less likely to produce cross modulation between several frequencies which are impressed on the transmitter at the same time. Fundamental tests made on high level modulation circuits indicate that they are exceedingly free of this type of distortion.

In the exciter unit two crystal oscillators using RCA-802 tubes are so arranged that an instantaneous switch can be made from one crystal unit to the other. This is accomplished by means of a relay controlled from the front panel. Following the crystal oscillator unit a single RCA-

828 stage drives an intermediate amplifier employing two RCA-810 tubes. The intermediate amplifier drives a single 892-R tube, whose anode is equipped with an external copper fin structure for dissipating the heat. The power amplifier employs four 893-R tubes in a parallel circuit arrangement. The tank circuit is of the filter type (of the same general design as that used in the RCA 5-D transmitter) and enables an accurate match to be made between the tube impedance and that of the transmission line. This type of circuit makes for simple tuning and adjustment and, in fact, may be employed as a method of controlling the power output of the transmitter to compensate for variations of supply line voltage since the circuit efficiency is not changed appreciably. This tank circuit provides a direct single-ended connection to the transmission line thus avoiding the additional complication of coupling circuits required with a push-pull system.

The audio system begins with two RCA-1603 low microphonic amplifier tubes which drive an intermediate amplifier using two RCA-828 tubes. Four RCA-828's serve to drive the two 893-R modulator tubes. For stand-by operation, an additional audio system is supplied and mounted in a separate frame to allow modulating the exciter stage so that it may be used as a separate transmitter. Two 1603 input tubes drive two RCA-828's and the third stage employs two more RCA-828's which drive two 892-R tubes as a 5 KW modulator. The power supply equipment normally employs three rectifiers, a 1500-volt intermediate rectifier consisting of two RCA-872-A's, a bias rectifier employing two RCA-872-A's and the main high voltage rectifier using six RCA-857-B's in a three-phase, full wave system. It is interesting to note that the voltage required for this high level modulation system is only slightly more than half that normally required for linear amplifiers and with this lower operating voltage, the danger of flashover is greatly minimized. To provide for stand-by operation of the exciter unit, two additional rectifiers are supplied, one consisting of an additional bias rectifier with two RCA-872-A's and the other an emergency 8000 volt rectifier using six RCA-872-A's in a three-phase, full wave circuit.

During stand-by operation the main rectifier is not used and hence may be worked upon without danger since it is protected by interlocks and an automatic grounding switch. The main rectifier is provided with Delta Wye switching so that it may be operated at 16 KW for tuning or test purposes.

## SPECIFICATIONS

Power Output: 50 KW. Frequency Stability:  $\pm 10$  cycles. Frequency Response:  $\pm 1$  db. from 40 to 10,000 cycles.  $\pm 2$  db. from 30 to 12,000 cycles. Audio Distortion: Less than 3% from 50 to 7500 cycles at 90% modulation. Noise Level: 60 db. below 100% modulation. R. F. Harmonics: 70 db. below carrier fundamental measured at one mile. Power Consumption: 110 KW without modulation. 120 KW for 25% modulation. 156 KW for 100% modulation. Power Supply Requirements: 2300 volts, 60 cycles, 3 phase, with 5% maximum regulation and variation. The equipment can be adapted for 50 cycle operation by minor modifications.

# TRANSMITTER ACCESSORIES

## ANTENNA TUNING UNIT, 1 KW TYPE AZ-4293

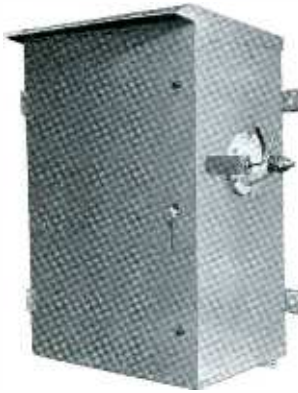

THE MI-7423, Type AZ-4293 Antenna Tuning Unit provides for terminating a transmission line, and matching the line of a broadcast transmitter to the antenna radiator. It is designed to match a transmission line having an impedance of 70 to 350 ohms, one side of which is grounded, to an antenna having a reactance of plus 200 ohms to minus 200 ohms and a resistance of from 20 to 200 ohms.

It consists of a number of tuning elements housed in a weather-proof metal box and is intended for installation on wooden posts, a wooden platform or a steel cradle. An opening is provided in the bottom of the housing for entrance of a concentric tube transmission line, but the unit may also be used with an open wire type of line by addition of an entrance bushing, MI-19406.

Electrically, the unit consists of a low-pass impedance-matching filter using a "T" type network. Adjustments of the line inductance and the antenna loading inductance are made by a selection of taps on these two items. The shunt branch of the network consists of case 99 Faradon capacitors. The number and value of these capacitors will vary with the resistance and reactance of the antenna, the operating frequency, and the impedance of the transmission line, which electrical values — or a description of the line and antenna — must be furnished in order that the proper Faradon capacitor values may be selected for the particular installation in question. A switch is provided for shorting the antenna ammeter when readings are not being taken. The antenna ammeter is a Weston Model 425 with a bakelite case. The unit has been designed for use with the following transmitters: 100-H, 250-D, 100-G,

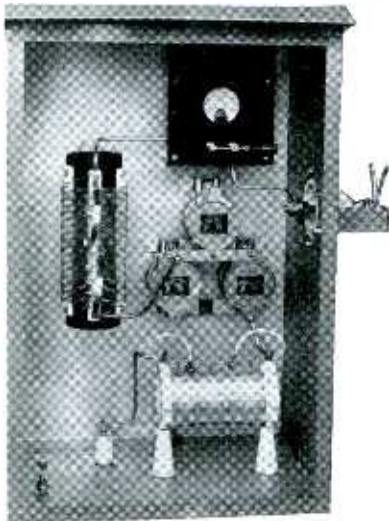

250-G, 250-K, 1-G, 1-E, 1-K. This tuner is designed for ready installation of a remote metering kit, MI-19404, for remote indication of the antenna current.

Dimensions: 30" x 22" x 16 $\frac{3}{8}$ "

## LIGHTING CHOKE COIL TYPE 92-A ANTENNA



BROADCAST transmitter installations where the tower itself forms the antenna, must be provided with special transformers or radio frequency choke coils to feed power to the lighting circuits on the tower. The Type 92-A Antenna Lighting Choke consists of a double winding on a suitable form. Its electrical characteristics are such that it has low impedance to the commercial lighting frequencies and high impedance to the radio frequencies in the broadcast range. It therefore provides a means for supplying energy to the tower lighting circuits and at the same time prevents any appreciable loss of r-f energy supplied to the tower by the radio transmitter.

The coil windings are coated with an insulating varnish which binds the turns together and prevents moisture absorption. This coil, however, must be protected from the weather by providing a mounting for it within some weather proof enclosure. Such an enclosure or housing is not provided with the unit nor available for sale.

The electrical characteristics are:

Maximum current—18 amperes (continuous 50/60 cycles)

1000 cycle inductance—540 micro henries (approx.)

DC resistance (total, both windings)—1.1 ohms (approx.)

The natural resonant frequency of the coil is well removed from any frequency within the broadcast band. Its characteristics therefore are such that it presents a very high impedance at all broadcast frequencies.

Two MI-7112, Type 92-A Antenna Lighting Choke Coils may be used in parallel where the load or circuit requirements exceed the ratings of a single coil. All windings that are not directly connected to the tower or to ground, should be properly by-passed by suitable capacitors, such as RCA Type UC-3006, Case 99, .01 mfd.

Dimensions: Length, 33 $\frac{1}{2}$ " x Diameter 4"



# ANTENNA TUNING UNIT

Type 105 . . . MI-7444

**T**HIS line-terminating equipment is distinctly new in design and extremely flexible in application. It may be employed to match antennas of widely divergent characteristics to either a concentric or open-wire transmission line on transmitters up to five- or ten-kilowatt output.

In construction, the Type 105 is not complicated since the circuit elements are reduced to a minimum. All parts are enclosed in a weather-proof metallic housing equipped with a door at the front for ready access to the interior. The antenna ammeter is readable through a circular window in the door, and is protected against lightning surges by means of a short-circuiting switch actuated by the knob on the right-hand side.

Various combinations of inductance, capacitance and tap connections to the transmission line and antenna are available. Such variations are provided in order to satisfy conditions imposed by widely different antenna characteristics and broad frequency coverage. Sufficient wiring is furnished to effect all practicable arrangements. Surplus leads should be removed after a circuit has been selected.

Audio-frequency voltage for program monitoring and rectified current for remote antenna-current indication and transmitter control are available for use if desired. Such

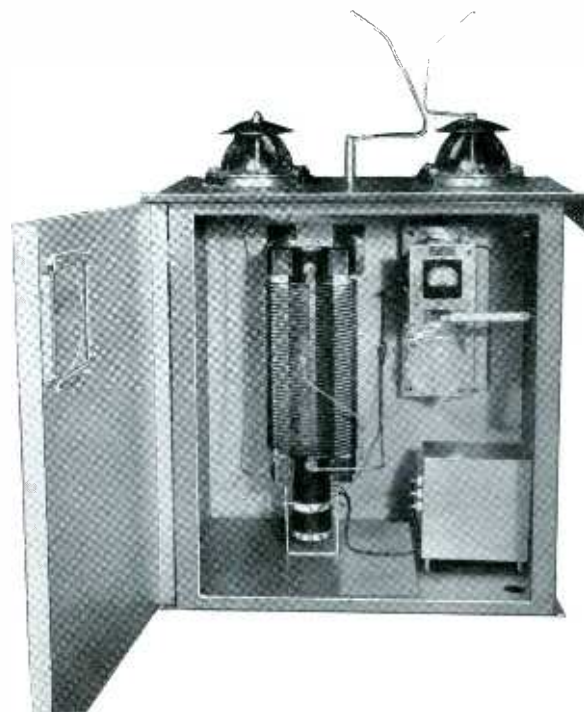

voltage and current are furnished by a monitoring-rectifier unit mounted inside the housing at the bottom.

This unit embodies the necessary equipment to enable the installation of a remote meter for measuring antenna current and also furnishes audio-frequency energy for operation of a monitoring amplifier. The method of remote antenna-current indication as outlined herein has been approved by the Federal Communications Commission. The rectifier utilizes an RCA-83-v tube.



## OPERATING LIMITS

Antenna resistance (ohms) . . . . .	8 to 1100
Antenna reactance (ohms) . . . . .	+1000 to -1000
Line impedance (ohms) . . . . .	50 to 300
Carrier frequency (kc) . . . . .	550 to 1700
Transmitter power (kw) . . . . .	10 (max.)

Monitoring Rectifier:

Output Impedance: To operate into 20,000-ohm bridging load.

Output Level: (db. approx., including bridging loss) -20 at 5 kw and -26 at 1 kw.

*NOTE—Reference level = 12.5 mw.*

Rectified Current: (ma d. c.): 75 (max.) into a maximum of 1000 ohms.

Frequency Characteristic: Substantially flat to 10,000 cycles.

# RCA ANTENNA

## FOR DIRECTIONAL ANTENNA



MI-7485-B  
Front View

Built for Station W'DRC

THE multi-element or directional antenna is becoming of increasing importance throughout the spectrum of radio frequencies. Various forms of directive arrays have been used for many years for short-wave work. In the past few years, arrays have become important in the broadcast band. The purpose of the arrays used in this range of frequencies has been twofold. In some cases, the energy is directed into a desirable or densely populated territory at the expense of a decrease in the energy sent out into the thinly populated territory, waste land, or large bodies of water. By far the greatest use of the directive array has been to prevent energy from going out in such directions which point toward the service areas of stations on the same or adjacent channels. The use of such arrays allows the stations to increase their power without increasing the amount of interference they cause to another station.

Many regional stations have been enabled, through the use of directional antennas, to increase their power from one kilowatt to five kilowatts without increasing the interference to other stations on the same channel. With the new channel classifications, we see directional arrays becoming of greater importance to even the fifty kilowatt stations.

The directional distribution of energy made possible through the use of antenna arrays is accomplished by using two or more tower antennas. Each tower is fed with a certain prescribed amount of power. This power must be accurately controlled as to magnitude, and must radiate from each tower at the correct instant of time, relative to each other tower. In other words, the phase of the current in each tower must be accurately maintained with respect to the phase of the currents in the other towers.

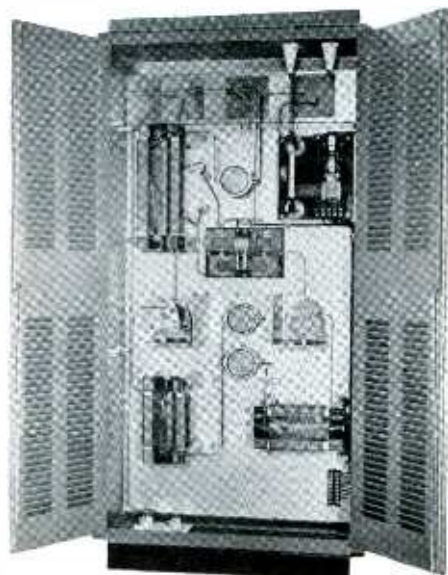

MI-7485-B  
Rear View

Built for W'DAE

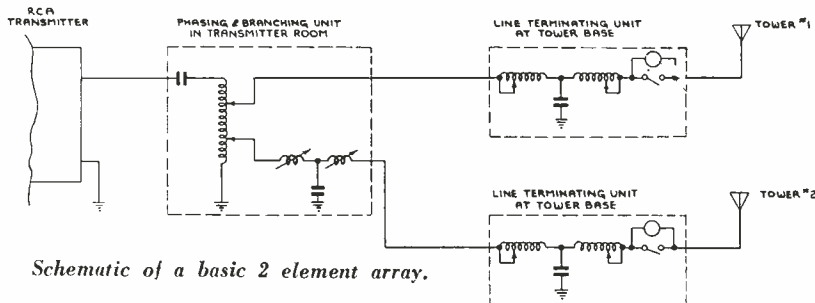

Schematic of a basic 2 element array.



MI-7485  
1 KW Phasing Equipment  
Built for KFRO



MI-7423  
1KW Line Equipment  
Built for KVOD

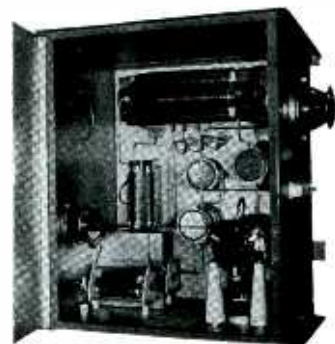

MI-7485  
5 KW 3 Element Phasing Equipment  
Wall Type Enclosure  
Built for WTAG

# PHASING EQUIPMENT

## ARRAY INSTALLATIONS

THUS, when we use an antenna system consisting of more than one tower, we must use antenna phasing and coupling equipment to maintain the desired directional pattern. The equipment is simply a network made up of the proper components so that the energy coming out of the transmitter divides in the correct proportions for each antenna, and arrives at the antennas at the correct instant of time.

RCA's policy is the individual design of each array in accordance with the recommendations of your consulting radio engineer, thus offering these outstanding advantages:—

(a) Optimum circuit design. For any given array the most desirable combination of networks may be chosen giving full consideration to simplicity, stability of operation and economy. (b) Equipment may be constructed so that it will match in appearance and design any existing installation. Often it is desirable to style the enclosures to permit alignment with our own transmitters. Where this is not desirable, simplified wall mounting enclosures may be employed for the utmost in economy. (c) Automatic switching from directional to non-directional operation may be included or omitted as the customer desires. (d) Metering facilities may be expanded or minimized as required. (e) Equipment is delivered completely wired for the circuits recommended, and information is furnished in each case showing the adjustment of every component. Under such circumstances installation time and time required for proof of performance are greatly reduced, and such simplification is a direct saving to the customer. (f) Every phasing unit is designed for the power at which it is to be used or for the anticipated maximum power of the station. (g) Full consideration is given to any special requirements of the individual customer. (h) Several types of enclosures and all circuit components are manufactured in reasonable quantities and are immediately available in stock in order that we may have the economical advantages of the single design and yet make reasonable deliveries.

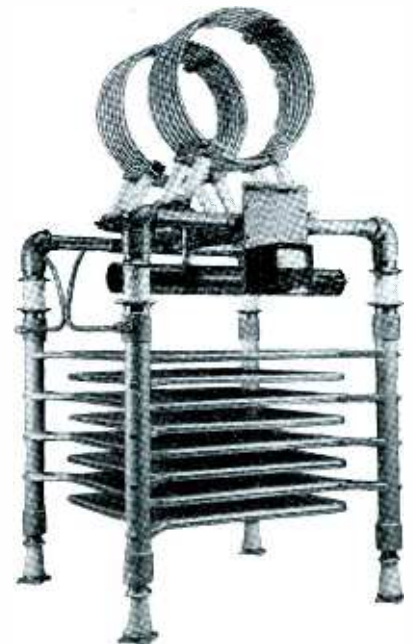

50 KW Line Terminating Unit  
Built for KWKH



1 KW Phasing Equipment  
Built for WLWL

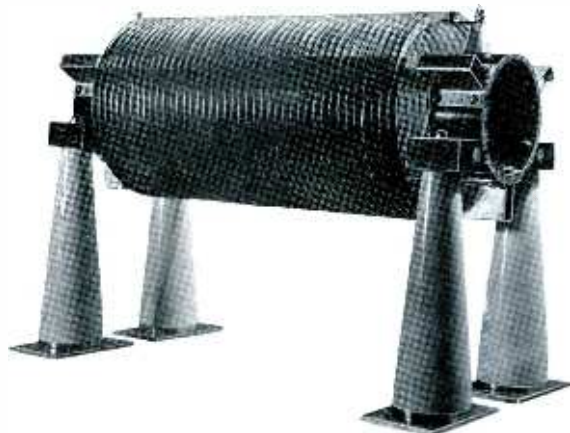

MI-7487  
125 mh Inductor



MI-7493-A  
25 mh Variable Inductor

# ANTENNA PHASING EQUIPMENT



*Typical RCA Installation at WPRO, Providence, R. I.*



*MI-7485-B  
Cabinet  
Front*

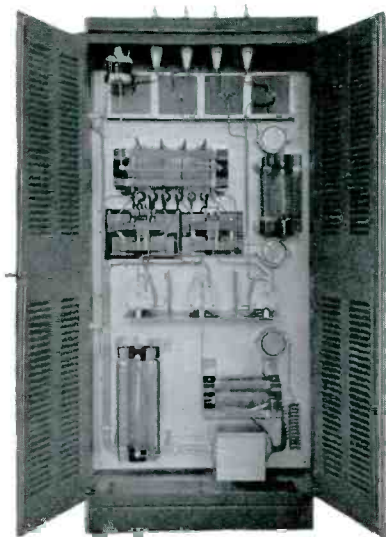

*MI-7485-B  
Cabinet  
Rear*



*Line  
Terminating  
Unit  
MI-7485  
enclosure.  
Closed*



*Line Terminating  
Unit  
MI-7485  
enclosure.  
Open*

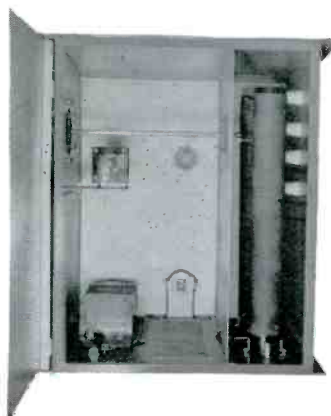

*Tower Lighting  
Equipment and  
Current Sampling  
Coil.*

*Type 300-A  
Phase Meter  
MI-7540*



*Type 300-B  
Remote Ant.  
Current Ind.  
MI-8216*



# RCA FREQUENCY MODULATION TRANSMITTERS

## *Simplified Electronic Automatic Frequency Control*

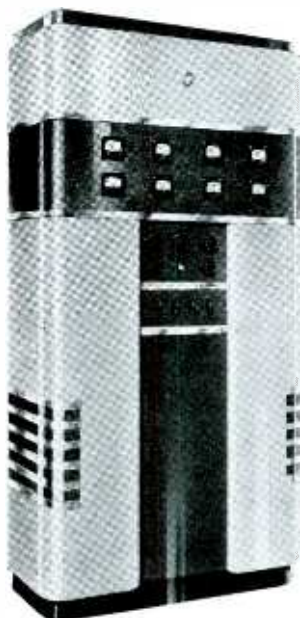

*The Type 250-FM, 250 watt set, is housed in the same attractively styled cabinet as the popular Type 250-K standard broadcast transmitter. It employs the RCA vertical chassis construction which provides maximum accessibility and reliability.*

of the Radio Corporation of America, its designs are not entirely dependent upon its own extensive research efforts and manufacturing performances. Of equal importance are the practical tests conducted by its affiliates which own and operate commercial radio equipment of all types. RCA knows first-hand the importance of employing simple, rugged designs which are reliable and lend themselves to years of commercial service with a minimum of depreciation and maintenance.

During its past years of both laboratory and operating tests, numerous methods of obtaining frequency modulation were tested and various new systems developed by RCA, including the widely accepted Crosby FM transmitter circuit.

Extensive tests have conclusively demonstrated that the Crosby circuit not only meets the requirements of frequency stability and high fidelity but that it is also the simplest method of directly obtaining true frequency modulation.

In the RCA direct method, the effective tuning of a master oscillating circuit is varied in accordance with the

### FM Pioneering by RCA

RCA recognizes Frequency Modulation to be of high technical merit when applied to ultra high frequency waves. The RCA Laboratories have been engaged in FM research continuously for many years, with careful consideration also having been given to phase and amplitude modulation. Extensive tests over actual radio circuits, which in some cases were several thousands of miles in length, substantiated the laboratory findings. As a direct result, RCA engineers have developed efficient and eminently practical apparatus for general use.

### Designs Based Upon Operating Experience

Because the RCA Manufacturing Company is a service

percentage of modulation by means of reactance tubes, producing frequency modulation directly without any intervening process.

In designing the RCA FM broadcast transmitters the Company has drawn upon its many years of experience in the design and manufacture of both standard and short wave broadcast transmitters, bearing in mind both the special technical requirements of ultra high frequency equipment and the practical operating facilities necessary in the commercial broadcast station.

These practical and technical facilities have been combined in equipments which are styled and built in the attractive but rugged construction for which RCA Manufacturing Company has been well known in the broadcast transmitter industry.

### Technical Features in RCA FM Transmitters

Two important RCA contributions to FM broadcasting are simplified electronic frequency control and reactance modulation.



*The FM-1-A Frequency Modulated Broadcast Transmitter is designed for high fidelity FM broadcasting and other special communication services in the 26 to 108 megacycle frequency range such as high fidelity television sound, facsimile broadcasting, educational broadcasting and similar UHF services, utilizing either FM or AM operation.*

*It includes the standard television sound transmitter, Type S-1, and the separate FM exciter, Type MI-19407.*

# RCA FREQUENCY MODULATION TRANSMITTERS

A combination of these two features has resulted in equipments which use a minimum number of tubes and circuits and exhibit exceptionally fine frequency stability and quality characteristics.

All of the RCA FM broadcast transmitters employ the same basic modulation and frequency control unit.

The modulated oscillator employs a highly stable electron coupled circuit. The center frequency of the modulated oscillator is continuously compared with the output of a very stable crystal oscillator. A standard automatic frequency control circuit electronically retunes the modulated oscillator should there be any tendency for it to deviate from its assigned center frequency.

Modulation is effected by a reactance modulator designed to have the characteristic of cancelling the effect of variations in the power supply voltage.

An even higher order of frequency stability is obtained in the RCA design by the use of a regulating power supply for the entire frequency control unit.

In the RCA sets transmitting Radiotrons Type 807 are employed as modulators, resulting in much wider linear operating range than if smaller tubes were used. Also, the characteristics of transmitting Radiotrons are held within closer tolerances and are more uniform than smaller tubes.

All frequency-affecting components of the exciter are mounted in a double heat box which is temperature-controlled to further enhance the frequency stability.

As a result of this careful attention to all factors involved in frequency stability, an exceedingly high degree of stability has been obtained. Actual tests show that even

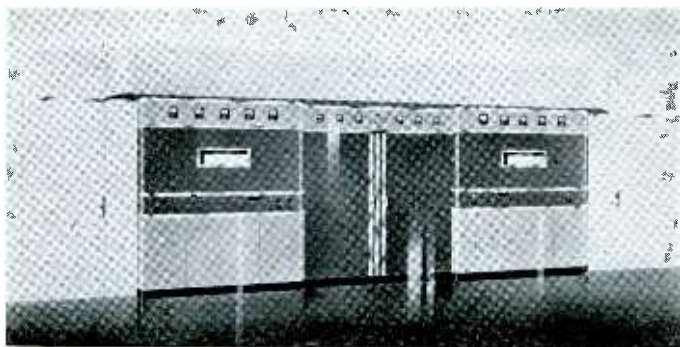

*The FM-10-A, ten kilowatt transmitter, styling is of the unified front design, similar to the new 5-D standard broadcast transmitter. The FM-1-B set serves as exciter, driving a ten kilowatt power air cooled output stage. The exciter is located behind the two central doors and all meters required for normal operation are located on the main meter panel above the doors.*

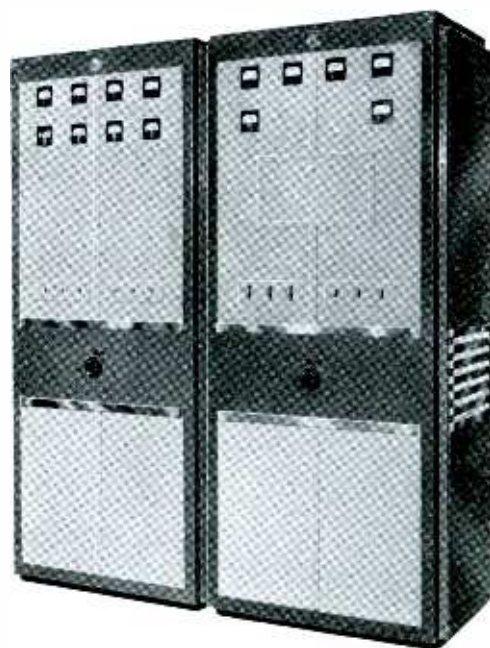

*The FM-1-B Frequency Modulated Broadcast Transmitter is designed for high fidelity FM broadcasting only and does not include facilities for AM operation although its radio frequency tuning range covers from 26 to 108 megacycles.*

*The FM-1-B set is also used as the standard exciter for the FM-10-A, 10 kilowatt transmitter. The FM-1-B set can be increased to three kilowatts power rating by replacing its standard power supply with one of the necessary higher powered capacity, the radio and audio frequency circuits being designed for operation at powers as high as three kilowatts.*

*The FM exciter is mounted in the right-hand cabinet which also houses the power supply and access to all normal exciter controls is provided through the small door in the front of the panel.*

though the temperature, humidity and power supply voltage are varied over wide limits, the equipment does not vary in frequency more than a fraction of the total frequency deviation allowed by the new FCC FM regulations.

All equipments employ the standard dead-front construction with no exposed voltages and access to the interior of the sets can only be had through interlocked doors.

Special provision is made for accurately adjusting the output power of the transmitters to the exact values required to obtain a proper field strength as specified in the station licenses.

Push-pull RF output stages are employed to insure efficient operation of the tubes at these ultra high frequencies and to keep harmonic radiation at a minimum.

A unique feature of RCA FM broadcast transmitters is the use of an automatic alarm circuit which will take the transmitter off the air by removing plate voltage from the

# RCA FREQUENCY MODULATION TRANSMITTERS

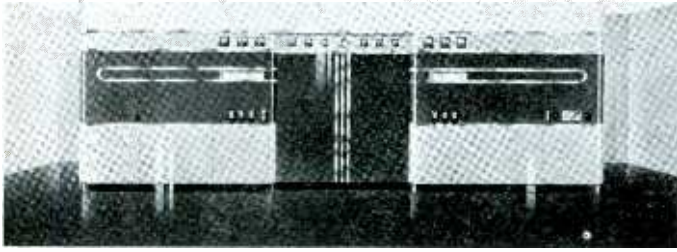

The Type FM-50-A, fifty kilowatt transmitter, also employs the modern RCA unified front type of design which effectively combines the various units and provides convenient centralized operating controls.

The fifty kilowatt power output stage is driven by a three kilowatt exciter symmetrically located in the center of the front panel.

tubes if, for any reason, the automatic frequency control circuit should fail to function. If desired, this automatic alarm circuit can be arranged to operate a visual or aural signal instead of removing the plate voltage.

All equipments meet the general specifications listed below:

Carrier Frequency Range: 42-50 megacycles. Transmission Line Impedance: 70-600 ohms. FM Noise Level: 70 db below 75 kc swing. AM Noise Level: 60 db below carrier. Audio Input Level for 75 kc Swing with Average Program: 0 VU. Radio Frequency Stability: Better than 0.0025%. Audio Response: Better than  $\pm 1.5$  db from 50-15,000 cycles. Pre-emphasis Characteristic: RMA Standard. Audio Distortion: Less than 2% RMS at 75 kc swing. Vernier Power Output Adjustment: Variable coupling. Standard Finish: Two-tone umber gray.

## MODEL RB-2 PACK TRANSMITTER

MI-8400

THE RB-2 Pack Transmitter furnishes two watts r-f output, crystal controlled and capable of 100% modulation for high fidelity portable relay broadcast service on frequencies between 30 MC and 41 MC. The total weight of the unit complete is 30 pounds and it may easily be carried, by means of the shoulder straps, on the back of an announcer-operator or porter.

The audio system has four important features; namely, modulation limiter, automatic gain control, negative feedback, and polarized circuits. A monitor-rectifier circuit is included in the chassis, permitting headphone checking of the transmitted signal. These features combine to assure high average modulation with low distortion.

The complete transmitter with battery supply for nine hours continuous operation is housed in an aluminum case. Tuning controls, batteries, tubes and crystal are available through a large door that is locked in place by spring fasteners. Switches controlling the filament and plate circuits, two meters, meter switch and two monitor jacks are accessible without opening the door. A carrying handle is mounted on the top of the case and steel runners are fastened to the bottom for protection. The entire chassis may be easily removed from the carrying case for servicing.

A telescoping semi-flexible antenna attached to the equipment allows the operator to move freely about the scene of the broadcast pickup. A small pressure type microphone such as the RCA Model 88-A may be used by the announcer.

### SPECIFICATIONS

Power Output: 2 watts. Frequency Range: 30 MC to 41 MC. Dimensions:  $18\frac{3}{8}$ " high by  $13\frac{3}{4}$ " wide by  $5\frac{1}{2}$ " thick. Weight with Batteries: 30 pounds. Audio Response:  $\pm 2$  db. 80 to 8000 cycles. Distortion: Less than 6% RMS (100-7500 cycles) at 100% modulation. Input: 250 ohm microphone input terminated on Cannon receptacle. Frequency Stability: Using RCA Model TMV-135-E V-cut crystal, better than .03%. Limiter Range: Change of input from -70 db to -50 db is limited to 3 db change in audio output.



## **Construction Permit Application Data**

**I**N FILING applications for broadcasting construction permits (Form 301 for new stations and 304 for existing stations) on the following RCA broadcast transmitters, it is unnecessary to fill in all of the technical details referring to the transmitter since the information has been filed in Washington with the Federal Communications Commission at the time of approval of the equipment. It is only necessary to place beside each numbered question which refers to transmitter technical data the phrase "Information on file with F.C.C.". The type number of the equipment and the manufacturer's name—"RCA Manufacturing Company, Inc." should be filled in question 19. It should be noted that different power requirements call for differing type numbers as follows:

250-K	250 watts or 250/100 watts
1-K	1000 watts
5-DX	5000 watts
10-DX	10,000 watts
50-E	50,000 watts

Other transmitters than those listed above will require full technical data to be submitted and this information can be obtained from district offices. Applicants should not omit the data on antennas nor on necessary monitors. For convenience, the following are the type numbers and approval numbers on RCA equipment:

Type 66-A Modulation Monitor—1552  
Type 66-B Modulation Monitor—1553  
Type 311-A RCA Frequency Monitor—1462

### **FREQUENCY MEASURING SERVICE**

Checks on the accuracy of frequency monitors or on the settings of crystals in transmitters may be made by taking advantage of the RCA Communications Frequency Measuring Service. Measuring stations with extensive facilities are located on the East Coast and on the West Coast. Checks may be made periodically or individually, as required.



# RCA TELEVISION EQUIPMENT

AS a result of RCA's extensive research development and field test in all branches of television, RCA's wide experience in building both television transmitters and receivers, as well as actual television transmission conducted both in New York and Camden, N. J., the RCA television apparatus line is probably the most advanced ever offered in a new field. But in addition to extensive facilities for television circuit and tube development which have resulted in apparatus having electrical characteristics considerably superior to those actually required at present, the activities of RCA in the broadcast transmission field have furnished a guide to mechanical design and arrangement for maximum convenience, accessibility and flexibility. In addition, production facilities and manufacture of apparatus by economical methods enable RCA picture apparatus to be sold for prices comparable with equivalent sound broadcasting units, considering the more stringent requirements which must be met. As a result, RCA television apparatus units are obtainable with advanced circuit design, in commercial mechanical layouts and with performance exceeding present requirements in regard to frequency response, noise level and phase displacement. Equipment is available in unit form or in



*RCA Television Camera.*

complete chains for laboratory, experimental or transmission purposes.

## COMPLETE SYSTEM

RCA television apparatus includes receivers of several different types, video amplifier and terminal equipment, transmitters, vacuum tubes, measurement apparatus and television field pickup units. It is significant that just as RCA produces a complete line of apparatus for broadcast transmission and reception, so RCA has designed an integrated line of television apparatus, complete even to the test equipment for operation or adjustment. Full information is available to prospective purchasers of any of this equipment although it is not practicable to provide more than a condensed outline of most of the line here. A description of the RCA measurement apparatus for television will be found in a separate section of this catalog and RCA television tubes are listed with other special purpose tubes in the rear of this book. Data on television receivers is available on request.

## VIDEO EQUIPMENT

RCA video apparatus, the parallel of the audio apparatus found in



*RCA Television Antenna atop Empire State Building.*

# RCA TELEVISION EQUIPMENT

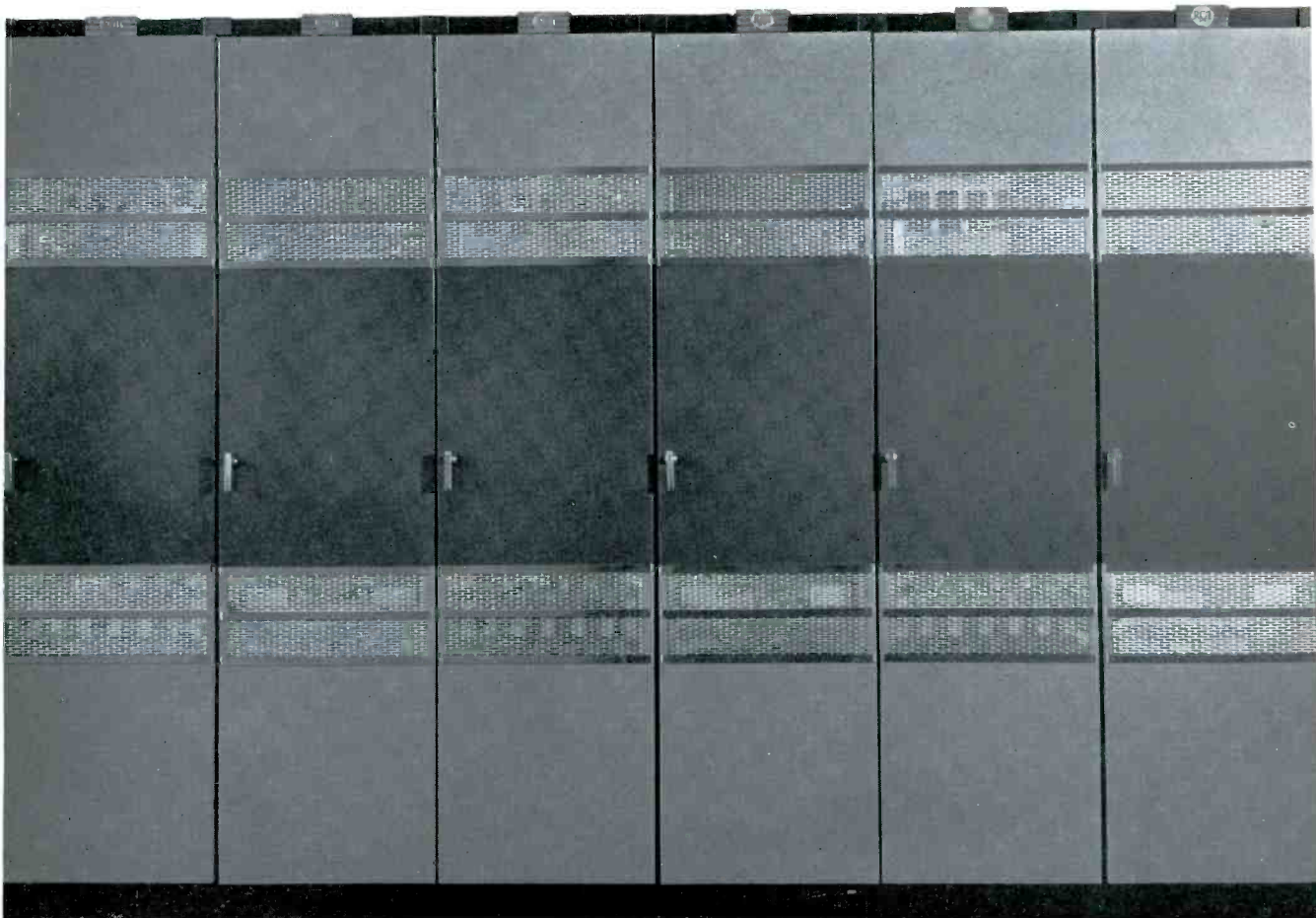

*RCA Video Equipment is housed in these racks.*

broadcast studios and control rooms, includes studio and film cameras, film projectors, camera apparatus chains, amplifiers, synchronizing generators, monitors and accessory equipment.

The design of the apparatus permits an equipment layout in many ways similar to that used in broadcasting. Each camera, containing a video preamplifier and associated apparatus, requires a "chain" of video equipment, mounted on a rack in the control room and performing the functions of amplification, the supplying of suitable deflection voltages to the Iconoscope, power supply, etc. The output of the camera chain may be switched to common apparatus used with any number of cameras and including a synchronizing generator and line amplifier. Monitors

may be employed for viewing the picture produced by each camera or on the output line. Picture oscillographs having wide frequency response characteristics are employed for setting levels and checking operation.

The RCA video panels are constructed for rack mounting and embody a special mechanical design arranged for accessibility as well as for carrying off heat from components and tubes. This construction, a modification of the vertical chassis design which has proved so popular in RCA broadcast transmitters, provides for the mounting of tubes, condensers and adjustment controls on the front of a dished chassis. On the rear are located the other components and interconnecting wiring. Instead of separate front

# RCA TELEVISION EQUIPMENT



*RCA 1 KW. Picture Transmitter Type T-1.*

panels, a door the full length of the rack is used. On opening this, all tubes are easily reached and grilles in the door promote good ventilation which is aided by the natural thermal circulation up the rack. The rear door of the cabinet rack affords access to the back of all panels where other components are located. Plate currents of most of the vacuum tubes may be read by plugging a portable meter into a jack and operating a selector switch for the desired tube. Provision is made for checking circuits with an oscillograph by connecting to terminals in the rear.

Operating controls are usually located on a control console which may be designed for any number of camera channels. Remote control of brightness and

gain is effected by means of d. c. circuits. Special coaxial cable terminations are furnished for video circuits on the units. Other apparatus including film projectors, camera stands, alternate lens systems, etc., is also available. Standard RCA broadcast studio equipment may be employed for the sound channel.

RCA video apparatus may be obtained in rack and panel design for any number of camera channels or in simplified cabinet form for use with one camera only.

## TRANSMITTER AND SPECIAL APPARATUS

The RCA 1 KW. picture transmitter, Type T-1, is a medium power television transmitter built to commercial standards and including a number of impor-

# RCA TELEVISION EQUIPMENT



RCA Television Field Pickup Equipment

An external partial sideband suppression filter is available, designed to reduce transmission of the lower sideband without disturbance of the picture. This filter is composed of several sections and is constructed of transmission line of the proper characteristics.

RCA television field pickup equipment allows for picture transmission by special wire line or by radio links to the main television station. Both video apparatus and very high frequency, small size radio transmitter units are included.

tant circuit developments. This equipment, crystal controlled and a. c. operated, employs tubes designed particularly for this application and is easy to install and to operate. The transmitter employs d. c. coupling between the modulator and power amplifier with special isolation circuits to permit operation of the tube filaments from a. c. Undesirable transient characteristics have been avoided by the use of carefully designed video circuits and novel power supply systems.

The transmitter is mounted in a well styled cabinet and includes an external power supply frame and water cooling unit for the power amplifier tubes.

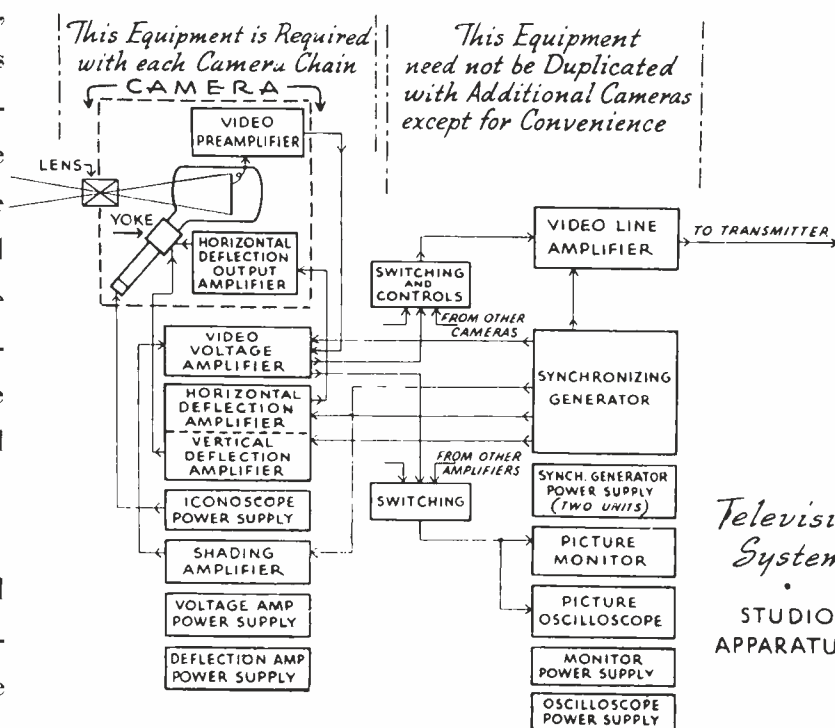

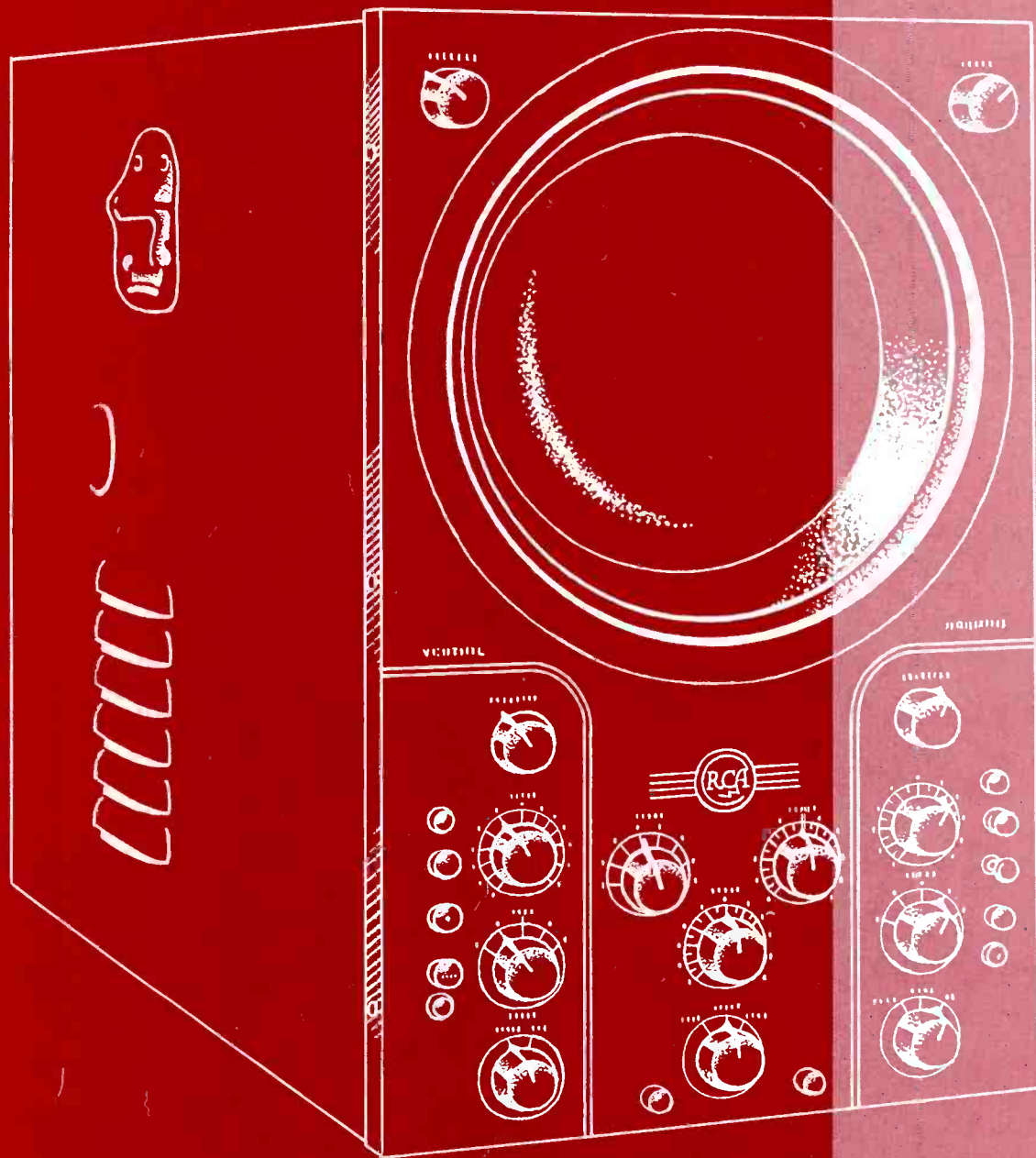

# MEASURING EQUIPMENT

# GENERAL PURPOSE APPARATUS

## CATHODE-RAY OSCILLOGRAPHS

One of the most widely used instruments in the radio industry is the cathode-ray oscillograph. It enables the engineer to observe intricate circuit phenomena with a degree of accuracy hitherto unattainable. The enthusiastic acceptance accorded this instrument in recent years has been due to its two outstanding advantages over any of its predecessors: (1) the indicating "pencil," being a beam of electrons, has entirely negligible inertia, permitting faithful reproduction of the wave form of current and voltage transients over an extremely wide range of frequencies; and (2) severe overloads may be applied without injury to the equipment, a feature which is extremely important in experimental work where it is sometimes impossible to predict the magnitude of voltages obtained in trial circuits.

Although practically unlimited in application, some of the more common uses of the cathode-ray oscillograph are: observation of recurrent and transient wave forms, measurement of current and voltage amplitudes, of audio-frequency distortion in amplifiers, hum measurement, checking percentage of modulation in transmitters, determination of unknown frequencies, alignment of radio receivers, and measurement of phase angles.

It is self-evident that the larger the tube, the greater the deflection and accuracy of measurement. For this reason, and because of the wide variety of applications involved, there has been developed a complete line of instruments ranging in size from a small portable unit, equipped with a 1-inch tube, to the large special television oscillograph with a 9-inch tube and weighing nearly 500 pounds.

### 9" SPECIAL CATHODE-RAY OSCILLOGRAPH

#### Type 305-A

**Applications:** The Type 305-A Cathode-Ray Oscillograph may be used in all general applications and possesses advantages over other types of oscillographs because of its extremely wide frequency range. It is highly valuable for modulation measurements on transmitters or for study of impulses or transients, showing wave shape of combined noise and desired signal. The 305-A is applicable to any class of work where low-or-high-frequency voltages of small amplitude must be studied. Also, since the horizontal and vertical amplifiers are identical and admit use of a wide range of input voltages, the instrument is ideally suited for measurement of phase delay in amplifiers and networks.

The Oscillograph finds application as a peak-reading voltmeter over an input range of 0.05 to 400 volts. A 60-cycle calibration source is provided by a metered circuit in the equipment, measurements being made by the substitution method.

**Description:** The deflection amplifiers of this de luxe cathode-ray oscillograph have been exceptionally well designed. Their response is essentially flat from 30 cycles to 10 megacycles; and, using square-wave input, distortion is under 5% at 30 cycles.

An integral saw-tooth oscillator provides linear timing, and may be synchronized with the signal in the vertical amplifier or with an external frequency. The synchronizing signal may be applied in either polarity, as desired. A phase-changing network permits synchronization of the timing-axis oscillator with the power-supply frequency. A blanking amplifier varies the grid bias of the cathode-ray tube from an external signal for introducing time or frequency calibration. Facilities are provided in the blanking amplifier for including a 20 megacycle tuned circuit for the production of dots spaced at .05 micro-second intervals on the Cathode-Ray tube screen. Thus the ten megacycle output of the type 350-A Square-Wave Generator can be impressed directly upon the blanking amplifier input terminal and the 20 megacycle dots automatically result. These dots are extremely useful in transient analysis work.

The cathode-ray tube, the RCA-914, is the largest commercially available and provides a large, brilliant trace suitable for either visual or photographic observation.

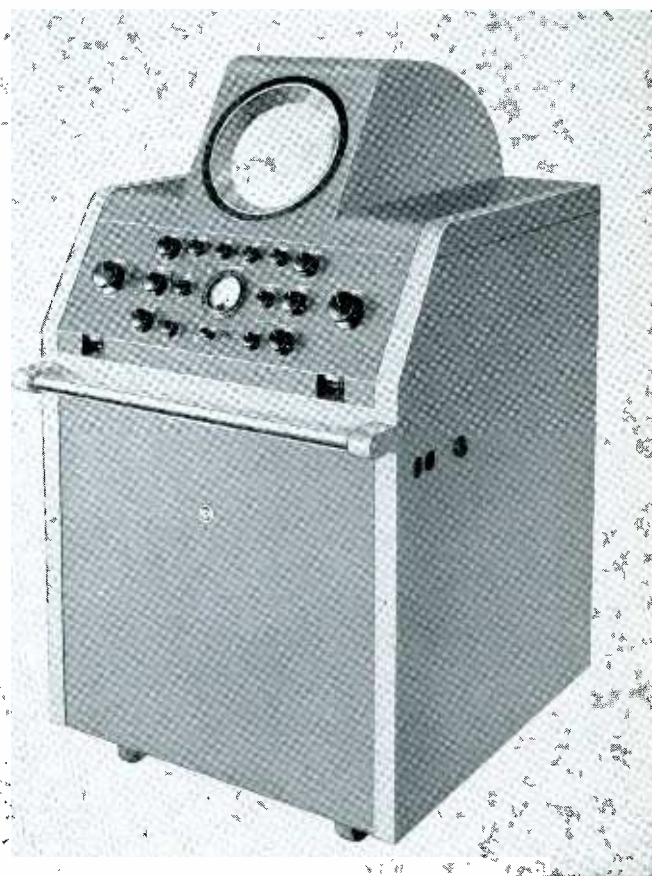

#### Specifications:

Cathode-ray tube	..... RCA-914, 9" screen, electrostatic deflection
Amplifier response	..... 30 cycles to 10 megacycles
Input Voltage Range	..... .05 to 400 Volts Peak
Timing-axis range	..... 30 to 30,000 cycles
Power supply	..... 110-120 volts, 50-60 cycles
Power consumption	..... 800 watts
Dimensions	..... height 50 $\frac{1}{4}$ ", width 29", depth 34"

## 9" CATHODE-RAY OSCILLOGRAPH Type 304-A

**Applications:** The Type 304-A Cathode-Ray Oscillograph is admirably well adapted to laboratory applications of all kinds. It has found a wide field of usefulness, also, in industrial fields, being especially valuable in studies of vibrations and internal-combustion engine pressures (see pages 103-5). Other uses include frequency comparisons, speed indications on small high-speed motors, and studies of noises and musical tones. It has innumerable uses in laboratories of colleges and technical schools, industrial testing divisions, and in research and experimental laboratories in almost every field of industry and education, for every application where a large, easily read trace is necessary or desirable.

**Description:** A laboratory-type cathode-ray oscillograph of modern design, employing the RCA-914 9-inch High-Vacuum Cathode-Ray Tube. Its trace is sharp and brilliant, permitting fast photographic recording of transients. The deflection amplifiers are essentially flat over a frequency-response range of 4 cycles to 100,000 cycles, and will faithfully reproduce square waves as low as 10 cycles in frequency. At the top of the panel are controls for focusing, and for adjusting the brilliancy of the image. Conveniently grouped below are horizontal and vertical centering controls, amplifier gain controls, and controls for synchronizing the sweep with either the wave form being observed or an external timing source.

**Features:** Two-stage deflection amplifiers with exceptionally wide range; blanking amplifier, a feature unique with this oscillograph, which varies the bias on the grid of the cathode-ray tube to interrupt the oscillographic trace at definite intervals for visual indication of time elapsed over any portion of the trace; opening in side of cabinet for direct connection to deflection plates; electronically regulated power-supply, insuring pattern stability irrespective of line-voltage fluctuations; safety interlock switch which automatically disconnects all power upon removal of instrument from cabinet; shield which protects cathode-ray tube against magnetic interference; distortion-free, shatter-proof glass protecting screen of cathode-ray tube from damage or breakage.



### Specifications:

Deflection sensitivity: With amplifier ..... 0.02 volt (r.m.s.) per inch  
 Amplifier response range ..... 4-100,000 cycles  
 Amplifier gain ..... 1450  
 Amplifier input impedance (at 1,000 cycles)  
     Push-pull ..... 1 megohm  
     Single-ended ..... 0.5 megohm  
 Timing-axis range ..... 4-18,000 cycles  
 Power supply ..... 110-120 volts, 50-60 cycles  
 Power consumption ..... 150 watts  
 Dimensions ..... height 20", width 12½", depth 24¾"  
 Weight ..... 98 lbs.  
 Radiotrons  
     1 RCA-914, 8 RCA-6C6, 1 RCA-885, 2 RCA-6J7, 1 RCA-6N7G,  
     1 RCA-879, 1 RCA-5Z3, 1 RCA-2A3, 1 RCA-874; total 17.

## 5" STANDARD CATHODE-RAY OSCILLOGRAPH No. 160

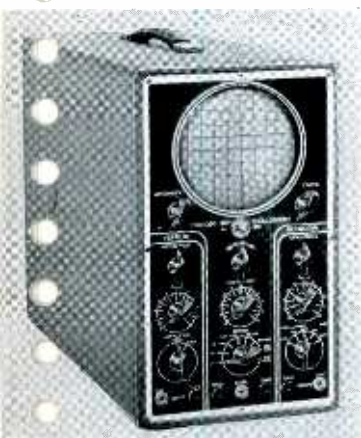

**Applications:** A modern, general-purpose oscillograph suitable for use in all commercial and educational laboratory work. Deflection amplifiers with exceptional low-frequency response and a very low-frequency timing-axis oscillator adapt this instrument admirably for engine-pressure indication and similar studies.

**Description:** The No. 160 oscillograph incorporates the recently introduced RCA-1802-P1 (5-inch) Cathode-Ray Tube. Low-distortion amplifiers are used for both vertical and horizontal deflections, two stages being employed in the former to provide extremely high sensitivity. Inputs, with

one side grounded, can be applied direct to either pair of deflecting plates, with no effect on the beam-centering circuits.

**Features:** New 5-inch cathode-ray tube affording large, clear trace; graduated viewing screen permitting direct measurement of deflection amplitudes; wide-range deflec-

tion amplifiers and low-frequency timing-axis oscillator providing unusual accuracy of measurement.

The RCA No. 158 5-Inch Oscillograph, similar to the No. 160, is also available for television-service applications. However, the frequency characteristic of the vertical amplifier of the No. 158 is essentially flat from 5 cycles to 500 kilocycles and is down only 50 percent at 1000 kc. Included with this instrument is a detachable coaxial input cable equipped with a special termination unit providing high input resistance and low capacitance.

### Specifications of No. 160:

Deflection sensitivity (with amplifier):  
     Vertical ..... 0.013 volt (r.m.s.) per inch  
     Horizontal ..... 0.56 volt (r.m.s.) per inch  
 Amplifier response range:  
     Vertical ..... 3-50,000 cycles  
     Horizontal ..... 5-100,000 cycles  
 Amplifier gain ..... vertical 1350; horizontal 31  
 Amplifier input resistance ..... 500,000 ohms  
 Timing-axis range ..... 4-22,000 cycles  
 Power supply ..... 105-125 volts, 50-60 cycles  
 Power consumption ..... 55 watts  
 Radiotrons  
     1 RCA-1802-P1, 3 RCA-6C6, 1 RCA-884, 1 RCA-879, 1 RCA-80  
 Dimensions ..... height 14¼", width 8", depth 24¾"  
 Weight ..... 30 lb.

### 3" SPECIAL CATHODE-RAY OSCILLOGRAPH No. 9641

**Applications:** The RCA No. 9641 Special Cathode-Ray Oscillograph is of an intermediate size using a 3-inch diameter cathode-ray tube.

This instrument has a very low-frequency timing-axis oscillator which commends it especially for laboratory and industrial applications of every type.

**Description:** This oscillograph is a moderate-sized instrument of sturdy metal construction. It uses the standard RCA-906 3-Inch Cathode-Ray Tube and is equipped with wide-range horizontal- and vertical-deflection amplifiers. A special low-frequency timing-axis oscillator has been incorporated in this model, adapting it ideally for industrial and mechanical research appli-

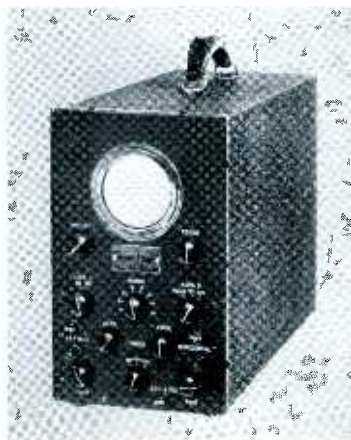

cations. The cabinet is attractively finished in gray wrinkle.

**Features:** Three-inch cathode-ray tube providing a large, easily read trace with sufficient detail for practically every application; convenient arrangement of all controls on front panel for ease of operation; high-fidelity deflection amplifiers and a timing oscillator with extended range, providing exceptional flexibility of operation; jacks on side of cabinet permitting direct connection to deflection plates for observation of d-c phenomena; graduations on the viewing screen facilitating accurate measurement of deflection amplitudes.

#### Specifications:

Deflection sensitivity: With amplifier..... 0.7 volt (r.m.s.) per inch  
 Amplifier response range..... 4-90,000 cycles  
 Amplifier gain..... 40  
 Timing-axis range..... 4-18,000 cycles  
 Power supply..... 110-120 volts, 50-60 cycles  
 Power consumption..... 50 watts  
 Dimensions..... height 12¼", width 7¼", depth 17¾"  
 Weight..... 39 lbs.  
 Radiotrons  
 1 RCA-906, 2 RCA-57, 1 RCA-80, 1 RCA-879, 1 RCA-885;  
 total 6

### THE TYPE 315-A ELECTRONIC SWITCH

**Applications:** The Type 315-A Electronic Switch is almost indispensable where it is desired to compare wave forms as to shape, phase, etc. By means of this instrument it is possible to observe two voltages simultaneously on the screen of a Cathode-ray tube. The traces of the two wave forms being observed may either be superimposed on one another or may be separated one above the other by an amount adjustable by means of a control knob. The instrument is useful in engine pressure work where it is desired to study injection and explosion pressure diagrams. It also finds application in observations of the timing of relays, phase relation of vibrators, power factor and general frequency measurements.

The 315-A constitutes a convenient source of square waves varying in frequency from 10 to 7500 cycles.

**Description:** The Type 315-A Electronic Switch consists essentially of two single stage amplifiers which are alternately made conducting and whose outputs are common. Thus while one amplifier is conducting the output wave form is that applied to its input. Similarly while the other amplifier is conducting the output is similar to the voltage applied to its input. If the rate of conductivity between the two amplifiers (their switching rate) is lower than the frequency of the two wave forms under observation they will be viewed alternately on the screen of a cathode-ray tube. However, due to the retentivity of the eye and of the fluorescent material on the screen the two wave forms will both appear simultaneously. If the switching rate is high with respect to the frequency of the applied wave forms practically simultaneous observation results, since the waves will appear as a series of dots on the screen. What actually appears upon the screen is first a small section of the output of one amplifier output and then a small section of the other amplifier output.

This form of observation is usually preferable especially if the wave forms being studied vary from cycle to cycle.

#### Specifications:

Switching rate..... 20 to 15,000 cycles per second  
 Square wave frequency..... 10 to 7500 cycles per second

#### Amplifier A and B

Gain on low output..... 3  
 Frequency response on low output .5 to 250,000 cycles per second  
 Gain on high output..... 40  
 Frequency response on high output .5 to 100,000 cycles per second  
 Maximum output, low..... 2.5 volts r.m.s. into 500,000 ohms  
 Maximum output, high..... 45 volts r.m.s. into 500,000 ohms

#### Amplifier C

Frequency range..... 5 to 15,000 cycles per second  
 Square wave output..... 15 volts peak into 500,000 ohms  
 Power supply..... 105-125 volts, 50-60 cycles  
 Radiotrons..... 2 RCA-6L7, 3 RCA-6SK7, 1 RCA-1852, 1 RCA-80  
 Power consumption..... 35 watts  
 Dimensions..... height 8¾", width 13¾", depth 6¼"





# GENERAL PURPOSE APPARATUS

## METERS

### ULTRA-SENSITIVE D-C METER No. 9819

**Applications:** The numerous uses of this precision instrument include measurements of electron currents, leakage currents, secondary emission, minute currents in photo-electric cells, electrolysis and corrosion currents and potentials, and galvanic currents and potentials. As a voltmeter, it gives accurate measurements across high-resistance circuits; as a current meter it may replace wall galvanometers or similar sensitive instruments. The instrument is particularly advantageous for resistance measurements since no more than 0.5 volt d.c. is ever applied across the unknown.

**Description:** This meter is an extremely sensitive portable instrument for accurate measurements of current, voltage, and resistance in d-c circuits of low current values. It consists essentially of a multiplicity of input circuits, a feed-back amplifier, and a meter circuit.

Conversion for the three types of operation is accomplished by an eleven-position selector switch having six positions for current measurements, four for voltage, and one for resistance. A push-button used in conjunction with this switch provides a five-to-one step-up in sensitivity at any switch position. The feedback amplifier permits use of a rugged indicator and makes it impossible to burn out the meter through overload.

**Features:** Sensitivity greater than that of any portable meter of the pivot or suspension type, the most sensitive range giving a deflection of one scale division (over  $\frac{1}{16}$ " ) with a current of 0.0004 micro-ampere; stability on all ranges equivalent to that of delicate suspension instruments, with no necessity for critical adjustments; economy effected through employment of standard low-priced batteries.

#### Specifications:

##### Current Measurements:

6 scale ranges..... 0-0.02 to 0-10,000 micro-amperes  
Input resistance..... varies between 50 ohms and 5 megohms over the total current range

##### Voltage Measurements:

4 scale ranges..... 0-0.1 to 0-500 volts  
Input resistance..... constant at 5 megohms for all ranges

##### Resistance Measurements:

2 scale ranges..... 0.1-100 megohms; 20-1000 megohms  
Less than 0.5 volt d.c. across resistance  
Extended range to 200,000 megohms with external 90-v battery

##### Calibration Accuracy:

Current and voltage scales ..... 2% of full-scale reading  
Resistance scale..... 3% of scale length ( $3\frac{3}{8}$ " )

Radiotrons..... 3 RCA-1B4

Batteries... 7 Burgess No. 5540 or equivalent (7.5 volts each)

2 Burgess No. 2 Uni-Cell or equivalent (1.5 volts each)

2 Burgess No. 4 FA or equivalent (1.5 volts each)

Dimensions..... height 13", width 9", depth  $8\frac{3}{4}$ "

Weight (with batteries)..... 20 lbs.

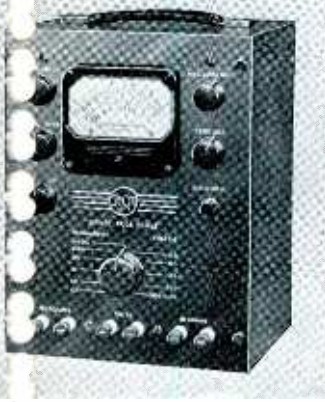

### WIDE-RANGE LOGARITHMIC AUDIO METER Type 302-A

**Applications:** This instrument, sometimes called a noise meter, is ideal for determination of signal-to-noise ratios in field-intensity measurements. Equipped with a logarithmic scale and a tapped input attenuator, it is usable over an operating range of 85 db, from -25 db (0.044 volt) to +60 db (775 volts) referred to a zero level of 0.001 watt across 600 ohms. Readings, in decibels, are obtained simply by adding algebraically the meter indication and the attenuator setting.

Other applications include checking the response of loudspeakers, receivers, amplifiers, etc. at any desired frequency within its range. Using a microphone and a preamplifier, the instrument becomes an excellent sound-level indicator. Sufficient output is available to operate any 5-ma recorder having a resistance of not over 560 ohms, a jack being provided on the front panel for connections.

**Description:** The Type 302-A meter is a vacuum-tube voltmeter, whose characteristic is so controlled that the indicating-meter variation is logarithmic. It consists of two audio-frequency amplifier stages followed by a combined diode detector and d-c amplifier. An internal source of calibrating voltage is provided by a neon-tube oscillator, insuring accuracy of measurement within 1.5 db over a frequency range of 60 to 15,000 cycles. Cables are supplied for audio-input and power-supply connections. The instrument is very light in weight, and is contained in a sturdy metal case equipped with a removable hinged cover and a snap-type handle.

**Features:** Logarithmic indication, which gives an extremely wide voltage range and, at the same time, provides easy reading on a linear decibel scale in conjunction with an input attenuator tapped at even 5-db steps; jack on the front panel providing for connection of a recording milliammeter.



#### Specifications:

Frequency response.....  $\pm 1$  db, 60-15,000 cycles

Accuracy (overall).....  $\pm 1.5$  db

Meter scale.....  $\pm 1$  db

Input attenuator.....  $\pm 0.5$  db

Sensitivity..... -25 db; zero level = 0.001 watt, 600 ohms

##### Operating range

Overall..... 85 db, -25 db (0.044 volt) to +60 db (775 volts)

Meter scale..... 40 db (-20 to +20)

Input attenuator..... 15 db (-5 to +40)

Input impedance..... 500,000 ohms

Power requirements—(see 93-A Power Supply, page 7)

"A"..... 6 volts, 0.9 ampere (a.c. or d.c.)

"B"..... 150 volts, 19 ma (no signal)

Radiotrons..... 2 RCA-6K7, 1 RCA-6R7, 1 RCA-991, 1 G-10

Dimensions..... height 12", width  $9\frac{1}{2}$ ", depth  $5\frac{7}{8}$ "

Weight..... 9 lbs.

# POWER SUPPLY EQUIPMENT

## PLATE SUPPLIES

### A-C REGULATED POWER UNIT Type 580-A

**Applications:** This equipment is designed to furnish plate-supply power for large radio and television apparatus. Loads up to 400 milliamperes at 300 volts d.c. are permissible.

**Description:** The Type 580-A contains a full-wave rectifier, and a reactor input filter whose output is passed through series regulator tubes controlled by a d-c amplifier. Negligible ripple and excellent regulation characterize this unit.

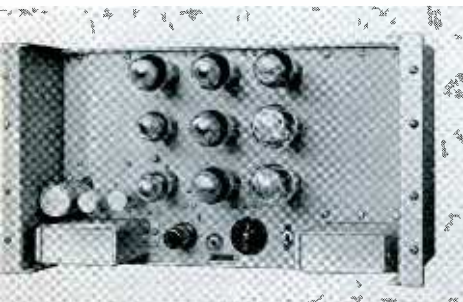

A special filter panel, Type 582-A, is available for external use with this equipment. It contains a 1000 - mfd

capacitor for connection in the d-c output circuit.

**Features:** Special regulating circuit maintaining constant output irrespective of normal variations in line voltage and load requirements; excellent regulation; negligible ripple content; designed for rack mounting.

#### Specifications:

Maximum output..... 400 ma at 300 volts  
 Regulation.....  $\pm 1$  volt, 50 to 400 ma  
 Hum level..... less than 0.05 volt  
 Power supply..... 110-120 volts, 60 cycles  
 Power consumption..... 425 watts  
 Radiotrons..... 2 RCA-VR-150, 2 RCA-5U4-G, 5 RCA-6Y6-G,  
 1 RCA-1852; total 10  
 Dimensions..... height 10½", width 19", depth 12½"

### REGULATED POWER UNIT Type 310-A



**Applications:** This equipment supplants the "B" batteries recommended for non-powered laboratory-type instruments.

**Description:** The Type 310-A is an electronically regulated a-c power unit

using a full-wave rectifier circuit. The output voltage is maintained essentially constant over an extremely wide voltage range by means of a special regulating circuit utilizing four tubes.

**Features:** Voltage regulation better than that obtained with heavy-duty batteries; special regulating circuit which maintains output essentially constant over wide range of loads and line voltages; well-filtered output, reducing hum content to negligible proportions; control on front of cabinet permitting easy adjustment of output to desired value.

#### Specifications:

Permissible outputs { (a)..... 80 ma at 135 to 180 volts  
 (b)..... 40 ma at 135 volts, and 20 ma at 90 volts  
 Higher voltages up to approximately 250 volts at reduced output currents may be obtained as indicated in the chart below.  
 Output variation.....  $\pm 1$  v. with supply-line variations of  $\pm 10$  v.  
 Power supply..... 90 to 130 volts, 50-60 cycles  
 Power consumption..... 70 watts  
 Radiotrons..... 1 RCA-80, 1 RCA-2A3, 2 RCA-874, 1 RCA-57; total 5  
 Dimensions..... height 7¼", width 12", depth 7"  
 Weight..... 25 lbs.

### VIBRATOR POWER UNIT Type 93-A

**Applications:** The Type 93-A Vibrator Power Unit has been designed for use with field test equipments, and provides sufficient power for simultaneous operation of the Type 301-A or 308-A Field-Intensity Meter with the Type 302-A Noise Meter.

**Description:** This device comprises a synchronous vibrator and transformer for procuring high-voltage d.c. from a 6-volt storage battery. The high-voltage supply is maintained constant over the normal discharge-cycle of the storage battery by a voltage-regulator tube. The cabinet houses the storage battery, power cable and accessory "C" batteries.

**Features:** Regulated circuit, insuring constant output over voltage range during discharge of storage battery; proper filtering, reducing hum level to a minimum; two values of output, available for use where required.



#### Specifications:

Maximum output { (a)..... 30 or 45 ma at 150 volts  
 (b)..... 7.3 ma at 90 volts  
 Hum level..... less than 2 millivolts on full (150-volt) output  
 Power supply..... 6-volt, 38 ampere-hour, storage battery  
 Radiotrons..... 1 RCA-VR-150-30  
 Dimensions..... height 14", width 13½", depth 7½"  
 Weight (less battery)..... 16 lbs.

# A-F & R-F MEASURING EQUIPMENT

## AUDIO-FREQUENCY INSTRUMENTS

### BEAT-FREQUENCY OSCILLATOR Type 68-B

**Applications:** The Type 68-B Beat-Frequency Oscillator is a high-quality laboratory-type audio oscillator having negligible distortion. It is unexcelled as an audio source for making distortion measurements, and may be used in any form of development work where a source of exceptionally pure audio frequencies is necessary. It has many other uses, such as for studying the frequency characteristics of transformers, amplifiers and commercial sound systems. Its output is essentially constant over the entire frequency range.

**Description:** Operation of this equipment is based on the conventional beat-frequency principle of heterodyning two radio-frequency voltages to form the low-frequency audio-output voltage. The two r-f voltages are generated by independent oscillators, one fixed in frequency and the other variable. Reaction between these oscillators is avoided by the use of electron coupling and very efficient shielding. Distortion is minimized by completely shielding the two oscillators, by maintaining a high ratio between the two r-f signal voltages, and by using balanced push-pull detector and amplifier stages throughout. A meter is provided to enable proper matching of tubes for these push-pull circuits.

Output impedances of 250, 500 and 5000 ohms are available from a terminal board at the rear. The output jacks on the front panel facilitate external connections in rack-mounted models. In cabinet models, the output terminals are accessible from a terminal strip on the side of the instrument.

**Features:** Vernier-controlled pointer traveling over a large direct-reading scale, for easy adjustment of frequency; electron-ray tube permitting ready checking of calibration

against the power-supply frequency; well-shielded electron-coupled oscillators, and push-pull detector and amplifier circuits, providing exceptional freedom from distortion; electronically regulated, built-in power supply, assuring constancy of output, irrespective of normal line-voltage fluctuations; extremely compact design, requiring only  $8\frac{3}{4}$ " of rack space.



The Type 68-B Beat-Frequency Oscillator, used in conjunction with the Type 69-B Distortion Meter described on page 92, is ideal for making harmonic distortion measurements on broadcast transmitters. Another unit useful in this application is the Type 89-B Attenuator Panel, by means of which suitable attenuation can be introduced to feed the distortion meter and the equipment under test. This unit, described on page 93, will save considerable time in setting up equipment for measurement.

A portable beat-frequency oscillator, Stock No. 154, is also available. This instrument is built primarily for field service applications, such as testing loudspeakers and public-address systems where requirements for accuracy of measurement are less stringent.

### Curves like these may be obtained using the 68-B

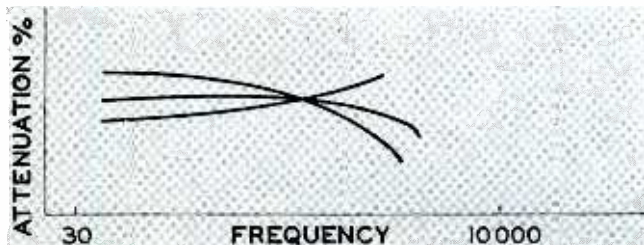

Typical line-equalization curves obtained by means of the 68-B

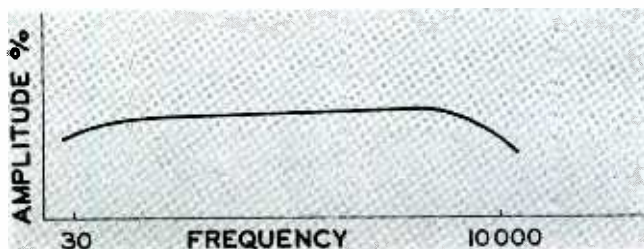

Example of typical frequency-response curve obtainable with 68-B

### Specifications:

- Frequency range.....20-17,000 cycles
- Usable output down to 5 cycles
- Calibration accuracy
  - Within 1 cycle below 100 cycles; within 1% above 100 cycles
- Power output.....up to 125 milliwatts
- Voltage output.....up to 25 volts
- Distortion.....(arithmetical sum of harmonics at full output)
  - Less than 0.3% below 100 cycles; less than 0.2% above 100 cycles
- Hum.....60 db below zero level (zero db = 12.5 mw, 500 ohms)
- Output impedances.....250, 500 and 5000 ohms, balanced
- Fidelity characteristics
  - 5000 ohms.....flat within 0.5 db
  - 500 or 250 ohms.....flat within 1 db
- Power supply.....110-125 volts, 25-60 cycles
- Power consumption.....70 watts
- Radiotrons.....6 RCA-6C5-G, 3 RCA-6J7, 1 RCA-45, 1 RCA-874  
1 RCA-5Z4, 1 RCA-6E5; total 13
- Height (Rack Model)..... $8\frac{3}{4}$ " (Cabinet Model).....9"
- Width (Rack Model).....19" (Cabinet Model)..... $19\frac{1}{4}$ "
- Depth (Rack Model)..... $10\frac{3}{4}$ " (Cabinet Model).....11"
- Weight (Rack Model).....50 lbs. (Cabinet Model).....55 lbs.

# A-F & R-F MEASURING EQUIPMENT

## AUDIO-FREQUENCY INSTRUMENTS

### DISTORTION METER Type 69-B

**Applications:** The Type 69-B Distortion Meter, used with a low-distortion audio oscillator such as the Type 68-B, permits rapid measurement of distortion, noise and frequency-response characteristics of broadcast installations from studio to antenna. Harmonic distortion can be determined at any frequency within the normal audio range. This is an outstanding advantage over most other comparable instruments which are usable only at specified frequencies. Since the distortion content may be many times greater at high and low frequencies than at the middle of the band, it is evident that single-frequency measurements are inadequate and often not even representative. The Type 69-B is reliable from 50 to 15,000 cycles, this range including all frequencies within the new FM requirements.

Fundamentally a laboratory instrument, the Type 69-B also finds many applications in radio development work. On radio receivers, for example, it is invaluable for measurements such as signal-to-noise ratio, hum level, and automatic volume-control range, as well as for locating sources of distortion. The instrument may also be used as a highly sensitive amplifier-voltmeter, its frequency characteristic being practically flat from 50 to 25,000 cycles.

**Description:** In the Type 69-B, both distortion and noise measurements are indicated by a direct-reading, multi-scale meter, actuated through an eleven-position selector switch.

Distortion measurements are made by balancing out the fundamental frequency of the unknown wave by the introduction of a sine wave equivalent in frequency and amplitude, but 180 degrees displaced in phase. This cancellation is accomplished by applying the unknown and sine waves to the respective grids of two tubes, whose output circuits

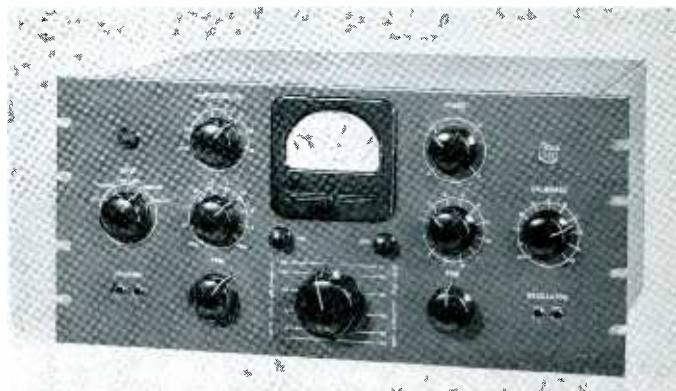

are connected in push-pull. The remainder, or harmonic content of the unknown wave, is measured by the meter as a total r-m-s percentage of the fundamental amplitude.

Audio-input impedances of 20,000 and 250,000 ohms allow bridging or direct-to-tube connection, as desired. A built-in linear r-f rectifier provides for measurements of distortion and noise in the modulated carrier output of transmitters. The output of this device is available for external connection of a cathode-ray oscillograph for wave analysis.

The Type 69-B Distortion Meter is mounted on a standard 19-inch rack panel and requires only 8<sup>3</sup>/<sub>4</sub>" of rack space. If preferred, it can be supplied in a sturdy metal cabinet suitable for table mounting.

**Features:** The outstanding feature of this instrument is its ability to measure distortion content and noise level over a wide range of audio frequencies. Other features are: easy, rapid calibration, accomplished without the use of other equipment; provision for bridging or direct-to-tube audio inputs; linear r-f rectifier included for direct measurement in the modulated output of transmitters; new, large size meter, extreme compactness of design, only 8<sup>3</sup>/<sub>4</sub>" of rack height being required.

#### Specifications:

Frequency range for distortion measurements...50 to 8,000 cycles  
 Distortion measurement range.....0.3% to 100%  
 Five scale ranges.....1%, 3%, 10%, 30% and 100%  
 Noise-level measurement range...down to 75 db below zero level  
 (12.5 mw, 500 ohms) or -85 db. below 100% modulation

#### Audio input impedance:

Bridging (balanced to ground).....20,000 ohms  
 Direct-to-tube (unbalanced).....250,000 ohms

#### Input level:

A-F: 20,000-ohm input.....-15 db to +22 db  
 250,000-ohm input.....-12 to 80 volts  
 R-F: For distortion measurements.....10 to 80 volts  
 Frequency characteristics: flat within 1 db from 30 to 25,000 cycles  
 Power supply.....105-125 volts, 25-60 cycles  
 Power consumption.....50 watts  
 Radiotrons...2-6C5G, 2-6J7, 2-6X5G, 1-6F8G, 1-VR150, 1-VR105

#### Dimensions:

Height (Rack Model)....8 <sup>3</sup> / <sub>4</sub> "	(Cabinet Model).....9"
Width (Rack Model)....19"	(Cabinet Model)....19 <sup>1</sup> / <sub>4</sub> "
Depth (Rack Model)....10"	(Cabinet Model)....12"
Weight (Rack Model)...52 lbs.	(Cabinet Model)...63 lbs.

### Curves like these may be obtained using the 69-B

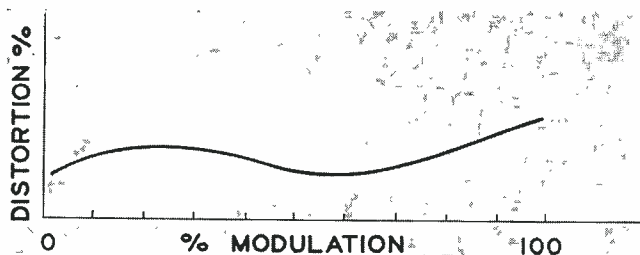

Curve measuring distortion in terms of modulation, indicated by 69-B

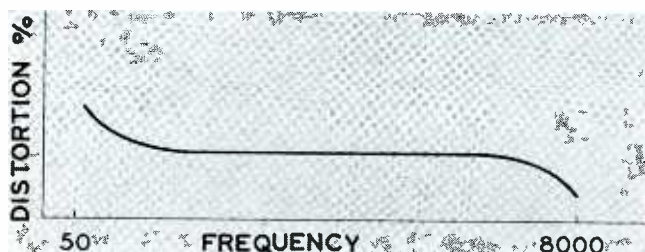

Curve showing distortion at various frequencies, indicated by 69-B

# A-F & R-F MEASURING EQUIPMENT

## AUDIO-FREQUENCY INSTRUMENTS

### ATTENUATOR PANEL Type 89-B



**Applications:** The Type 89-B Attenuator Panel greatly facilitates use of the Type 68-B and 69-B instruments by simplifying the work of setting up equipment for various measurements. It is particularly useful in broadcasting stations and laboratories because the improvement in operating convenience means a saving of much valuable time. It contains an excellent volume indicator, useful also for general measurement purposes.

**Description:** The Type 89-B consists of a volume-indicator meter, an attenuator system, an impedance-matching system, and jacks for external connections. A switch permits connection of the volume indicator to the attenuator system or to jacks. The attenuator system serves to control independently the amplitude of signal supplied by the beat-frequency oscillator to the equipment under test and to the distortion meter. Four switches in this system permit introduction of attenuation up to 75 db in steps of 5 db between the input and output jacks. Since the volume-indicator meter is also calibrated in decibels, direct reading of the input and output levels of the attenuator system is possible. An output-impedance switch allows matching to 500-, 250-, or 50-ohm circuits. It may also be obtained to match 600 ohm circuits and calibrated for a zero level of 1 mw., 600 ohms. The equipment is available in both rack and cabinet types.

**Features:** Panel jacks, affording utmost convenience in making all necessary connections; direct reading of input and output levels; volume indicator which may be used independently for measuring levels of other apparatus; choice of three output impedances providing ready matching to all commonly used circuits; compact design requiring only 5¼" of rack space.

#### Specifications:

Impedance values:	
Input.....	500 ohms
Output.....	500, 250 or 50 ohms
Volume indicator.....	20,000 ohms
Volume-indicator range	12.5-mw. zero level..... -10 to +12 db
	1.0-mw. zero level..... 0 to +22 db
Attenuation.....	0 to 75 db in 5-db steps
Operating limits:	
Input level.....	-10 to +12 db
Output, 500 ohms.....	-85 to +12 db
Output, 250 ohms.....	-95 to +2 db
Output, 50 ohms.....	-105 to -8 db
Dimensions:	
Height (Rack Model).....	5¼" (Cabinet Model).... 5¼"
Width (Rack Model).....	19" (Cabinet Model).... 19¾"
Depth (Rack Model).....	7" (Cabinet Model).... 8¾"
Weight (Rack Model).....	16 lbs. (Cabinet Model).... 18 lbs.

### VOLUME INDICATOR Type 13-D

**Applications:** The Type 13-D Volume Indicator is designed for accurate and convenient monitoring of program level in broadcast installations. It also has many uses in fields other than broadcasting, such as in measuring signal levels in sound-recording systems and on telephone lines.

**Description:** The Type 13-D is a high-fidelity, vacuum-tube voltmeter with adjustable dynamic response. Four meter speeds are provided to meet varying requirements of diverse applications. One gives a "floating" reading in accordance with F.C.C. specifications for modulation monitors; a second gives approximate "peak" readings; a third gives "average" readings; the fourth is the "high-speed" action of the meter alone. Any speed may be selected by the timing switch.

A signal rectifier of the vacuum-tube type is employed, insuring a sustained high degree of accuracy. Use of an isolation amplifier preceding this rectifier prevents reflection on the source. Input impedances of 500 and 20,000 ohms are available to permit use of either terminating or bridging connections.

**Features:** Direct indication of signal levels in decibels on large attenuator scale used in conjunction with meter; attenuator permitting zero indication of meter to be shifted from -20 to +18 db, thus providing measurement ranges of -30 to +20 db or -48 to +2 db, as desired; internal calibration source, adjustable for either 6- or 12.5-mw reference level, four meter speeds permitting choice of floating, peak, average, or high-speed readings; terminals at rear permitting connection of external meter for remote indication.

#### Specifications:

Measurement range.....	-30 to +20 db or -48 to +2 db (0 db = 12.5 mw, 500 ohms)
Frequency response.....	±0.5 db from 30 to 10,000 cycles
Input impedance.....	500 or 20,000 ohms
Power supply.....	105-125 volts, 50-60 cycles
Power consumption.....	30 watts
Radiotrons.....	2 RCA-76, 1 RCA-6A6, 2 RCA-84; total 5
Dimensions.....	height 6¾", width 19", depth 7¾"
Weight.....	25 lbs.

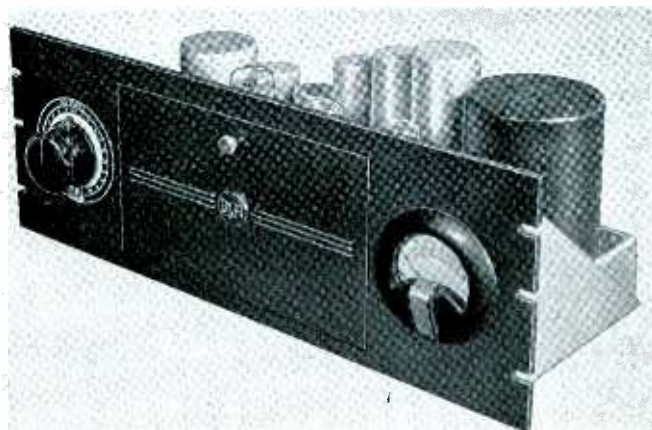

# A-F & R-F MEASURING EQUIPMENT

## RADIO-FREQUENCY INSTRUMENTS

### MODULATION MONITOR Type 66-A



**Applications:** The Type 66-A Modulation Monitor enables rapid checking of percentage modulation of broadcast transmitters, incorporating a neon peak flash lamp which furnishes an instant indication or warning when the degree of modulation exceeds a predetermined value. It satisfies the requirements of the Federal Communications Commission as set forth in Rule 139, Section (b). Readings can be made on either positive or negative modulation peaks. The instrument can be used in other applications in addition to its primary function, being particularly useful for measurements of average carrier value during modulation, carrier shift upon application of modulation, and program levels.

**Description:** This modulation monitor contains a linear diode r-f rectifier feeding two branch circuits, one for the neon peak indicator and the other for the modulation meter. A d-c milliammeter is employed in the plate circuit of the rectifier to indicate the average carrier value and

carrier shift during modulation. The peak-indicator branch circuit consists of an amplifier which triggers a gaseous discharge tube for operation of the neon lamp. Adjustment of the amplifier bias provides for operation at any value from 50% to 120% positive modulation, or from 50% to 100% negative modulation. The second branch incorporates a diode detector and a vacuum-tube voltmeter with the modulation meter connected in its cathode circuit.

The Type 66-A Monitor is provided with extra-large ( $4\frac{1}{2}$ " ) meters and a built-in relay for operation of a peak counter or auxiliary alarm. It is mounted on an  $8\frac{3}{4}$ " panel for standard relay-rack applications, but can also be furnished with a cabinet where table mounting is preferred.

**Features:** Approval of F.C.C. (Approval No. 1552), covering every requirement as to meter response, accuracy, frequency characteristics, and independence of supply-voltage variation; peak indicator which provides flashing signal as warning of over-modulation; direct reading of modulation percentages on either positive or negative peaks; built-in relay permitting connection of an external peak counter or auxiliary alarm.

#### Specifications:

General operating characteristics.....	as per F.C.C. regulations	
Accuracy (of percentage modulation readings).....	$\pm 2\%$ at 100% modulation, $\pm 4\%$ at any other percentage modulation	
Frequency response.....	$\pm 0.5$ db from 30 to 10,000 cycles	
R-F input.....	0.16 watt	
Power supply.....	110-120 volts, 50-60 cycles	
Power consumption.....	.40 watts	
Radiotrons.....	1 RCA-1-V, 3 RCA-76, 1 RCA-84, 1 RCA-885; total 6	
Dimensions:		
Height (Rack Model).....	$8\frac{3}{4}$ "	(Cabinet Model).....9"
Width (Rack Model).....	19"	(Cabinet Model).....19 $\frac{1}{4}$ "
Depth (Rack Model).....	$10\frac{3}{4}$ "	(Cabinet Model).....11"
Weight (Rack Model).....	50 lbs.	(Cabinet Model).....55 lbs.

### PHASE METER Type 300-A

**Applications:** The Type 300-A Phase Meter provides a simple means of accurately measuring phase differences between currents in the various towers of an antenna array. It is particularly useful in checking directional arrays to insure proper phasing and hence proper field pattern. All phase angles up to 360 degrees at any frequency between 200 and 1600 kc can be measured.

In addition to the above measurements, this instrument may be used to adjust phase-shifting networks, to measure impedances of arrays, and to facilitate calculation of mutual impedances of antennas. It enables quick and accurate phase measurements to be made between the elements of a directional antenna array, not only initially, but also as a routine check to make certain that the pattern has not shifted.

The instrument accommodates up to six lines, permitting the taking of measurements between any two elements in

systems having up to six elements. Selector switches are provided, enabling the operator to select any two lines at a time. The operation of the instrument is not affected by



# A-F & R-F MEASURING EQUIPMENT

## RADIO-FREQUENCY INSTRUMENTS

modulation; consequently, measurements may be made at any time while the station is on the air.

In addition to measurements of the phase difference between currents in various antenna towers, a number of other types of measurement are within the scope of the Type 300-A Phase Meter. It is useful in any application where phase angles between r-f currents or voltages are involved.

**Description:** The phase meter consists essentially of two resistance-coupled, three-stage, radio-frequency amplifiers which feed the two sets of deflection plates of a cathode-ray tube. One of the amplifiers contains a calibrated phase-shifting network which may be adjusted to secure an indication of in-phase conditions on the oscilloscope screen. The amount of phase shift introduced is then equal to the phase difference between the two input signals, and is read directly from the dial scale. The input impedance is approximately 80 ohms, permitting matching to low-impedance cables, and the required input signal is only one-half volt. The instrument is designed for standard relay-rack mounting, and requires  $8\frac{3}{4}$ " of rack space.

**Features:** Oscilloscope providing visual indication of proper adjustment; direct reading of phase angle in degrees from calibrated dial operating phase-shifting network; operation unaffected by modulation, permitting measurements to be made at any time while the station is on the air; facilities for connecting up to six r-f inputs simultaneously, a selector switch permitting measurements between any two of the six circuits as desired.

### Specifications:

Phase-angle range.....	0 to 360 degrees
Frequency range.....	200 to 1600 kc
R-F input impedance.....	80 ohms
R-F input voltage (approx.)...	0.5 volt minimum, 2 volts maximum
Power supply.....	105-125 volts, 50-60 cycles
Power consumption.....	120 watts
Radiotrons.....	2 RCA-956, 3 RCA-1617, 2 RCA-89, 1 RCA-913, 1 RCA-5Z3; total 9
Dimensions.....	height $8\frac{3}{4}$ ", width 19", depth 11"
Weight.....	42 lbs.

## TYPE 300-B REMOTE ANTENNA INDICATOR KIT



The 300-B is an accessory to the RCA Type 300-A Phase Meter. The unit is used to measure antenna currents in the individual towers used in directional arrays.

It consists of the radio frequency meters, sampling coils and other accessories necessary for the alignment and adjustment of either two or three element arrays.

The combination of a 300-B and a 300-A are indispensable to the station desiring to make the most effective use of its power by means of such antenna arrangements.

The 300-B is supplied in a panel type chassis suitable for installation in a standard rack. The unit is 7" in height and can be furnished in black, umber gray or transmitter gray finish.

When only two meters are used (for a two element array), the center meter punching in the front panel is covered with an attractive cover plate.

Meter units are provided according to individual station specifications.

# A-F & R-F MEASURING EQUIPMENT

## R. F. FREQUENCY MONITORING INSTRUMENTS

### FREQUENCY-LIMIT MONITOR Type 303-A

**Applications:** The Type 303-A Frequency-Limit Monitor is designed for checking the carrier frequency of transmitters operating in the range of 1500 kc to 60 megacycles, and indicating when the drift exceeds specified limits. This range includes high-frequency broadcast, international broadcast, police, and aviation services. The frequencies of mobile police transmitters and portable broadcast transmitters can also be checked or monitored with this device. It is likewise suitable for calibrating receivers, as a frequency meter for checking remote transmitters, and related applications, for which the monitor crystal oscillator provides a signal of known frequency. The 303-A also finds application in FM stations with the 306-A indicator.

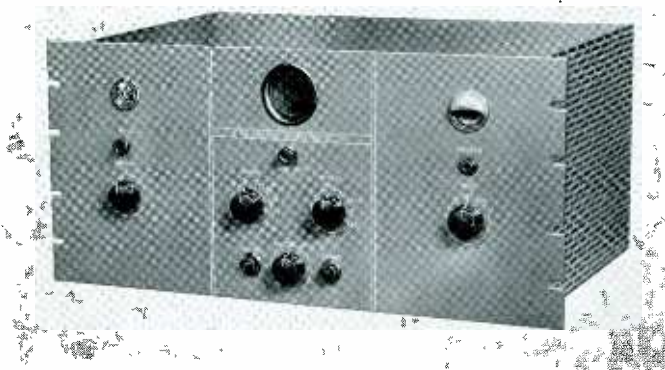

**Description:** The monitor controls are set for a predetermined limit of permissible frequency deviation; and if this tolerance is exceeded, the panel lamp will light, giving an immediate visual warning. These controls are so calibrated that the frequency deviation may be determined directly in cycles per second.

Monitoring is accomplished by the heterodyne principle, the carrier frequency being adjusted to beat with a local crystal oscillator emitting a signal (fundamental or harmonic) at the assigned transmitter frequency. The beat note between the two may be observed in head phones and will be the true difference tone. A jack is provided on the front panel for this phone connection. It is possible to easily determine whether the deviation is higher or lower than the carrier frequency by listening to the audio tone in the head phones while pressing a push button, noting whether the pitch increases or decreases. Four crystal positions are available, permitting use of this instrument on as many as four different channels within the overall frequency range through the crystal selector switch.

A magic-eye tube is provided for checking the r-f input level, oscillation of crystals, and operation of detector and audio-limit circuit. An extremely wide range of deviation may be monitored—50 to 25,000 cycles. This instrument can be supplied for either rack or table mounting, the latter type being furnished in a strong metal cabinet.

**Features:** Extreme accuracy of measurement, far in excess of average requirements, measurements within 0.005% being possible; employment of V-cut, low temperature-coefficient crystals, and mounting of the entire crystal-oscillator circuit in a heat-controlled chamber.

#### Specifications:

Carrier frequency range..... 1500 kc to 60 mc  
Frequency-deviation range..... 50 to 25,000 cycles  
Accuracy..... 0.005%  
Power supply..... 105-125 volts, 50-60 cycles  
Power consumption..... 100/125 watts total (operating),  
15 watts average (standby)

Radiotrons... 1 RCA 1612, 1 RCA-6J5-G, 1 RCA-6K7, 1 RCA-6J5  
1 RCA-6E5, 1 RCA-6H6, 1 RCA-6Y6-G, 1 RCA-5U4-G; total 8

#### Dimensions:

Height (Rack Model)... 8 $\frac{3}{4}$ " (Cabinet Model)..... 9 $\frac{1}{4}$ "  
Width (Rack Model)... 19" (Cabinet Model)..... 20"  
Depth (Rack Model)... 13 $\frac{5}{8}$ " (Cabinet Model)..... 13 $\frac{5}{8}$ "  
Weight (Rack Model)... 58 lbs. (Cabinet Model)..... 68 lbs.

### TYPE 306-A AUDIO FREQUENCY METER

The 306-A is an instrument which reads directly on a meter the frequency in cycles per second of voltage applied to its input. Ten linear ranges from 50 to 50,000 cycles full scale are provided on the indicating meter.

One of the most useful applications of the 306-A is in conjunction with the Type 303-A Frequency Limit Monitor for indicating the deviation from the assigned carrier frequency of a transmitter. The two instruments in combination will read frequency deviations (in the range of 1.5 to 45 megacycles) with an accuracy of .0025%.

The instrument may be used for monitoring remote, low power transmitters. This may be done by receiving the signal from the transmitter, beating it against a frequency standard detecting the beat note and feeding it into a 306-A which then will read the frequency of deviation.

Provision has been made in the 306-A to supply power sufficient to drive a 5 milliamperere recorder having an internal resistance of 1000 ohms or less.

The 306-A can be supplied in either the rack type or cabinet type mounting.

#### Specifications:

Frequency range..... 0-50,000 cycles in ten ranges  
Input (a) Voltage..... 1 to 200 v. r.m.s.  
(b) Impedance..... 250,000 ohms  
Recorder output..... 5.0 M.A., 1000 ohms max.  
Accuracy.....  $\pm 2\%$   
Power supply..... 105-125 volts, 50-60 cycles  
Power consumption..... 70 watts  
Dimensions—Height 8 $\frac{3}{4}$ ", Width 19", Depth 13 $\frac{5}{8}$ ".  
Weight..... 41 lb

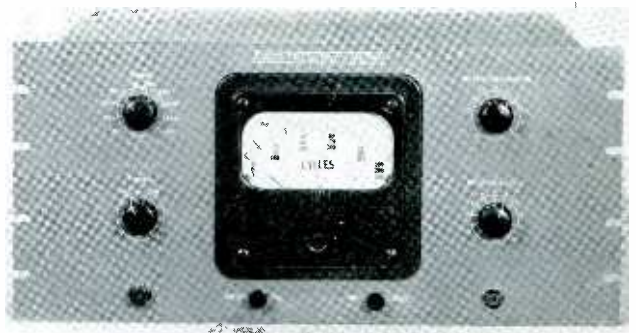



# A-F & R-F MEASURING EQUIPMENT

## R-F FREQUENCY MONITORING INSTRUMENTS

### TYPE 311-A FREQUENCY MONITOR

A PRECISION instrument designed to meet the new rigid requirements of the F.C.C. with regard to the carrier frequency stability of a broadcast station.

New regulations require that a station maintain its frequency to within  $\pm 20$  cycles of the assigned value. In order to avoid the paradoxical situation of a transmitter having greater frequency stability than that of its frequency monitor it was necessary to design an entirely new instrument having much greater accuracy than was known heretofore.

Expert transmitter engineers were assigned to the job and the 311-A is the result—a meter capable of reading carrier frequencies with extreme precision. Not content with having done such an outstanding job so far as accuracy is concerned, these engineers incorporated into the instrument other features which greatly improve the simplicity of operation and the stability of operating characteristics.

The instrument is of the rack-mounted type, and is styled to blend satisfactorily with modern attractive broadcast studio equipment. A large 6" indicating meter is mounted in the center of the panel enabling operators to read frequency deviations accurately from across a large room. This feature of reading indications at a glance saves much time and trouble to the station engineer.

**Description:** The 311-A embodies an extremely stable thermostatically controlled oscillator for producing a standard reference signal. This oscillator voltage is applied to a detector where it is mixed with the incoming signal from the transmitter. The frequency is adjusted so that a beat note of 1,000 cycles is produced. This 1,000 cycle note is impressed across a discriminator network constituted of a capacitive and an inductive branch. Diodes are connected across the two branches in such a manner that their currents cancel so long as the frequency remains constant at 1,000 cycles. If the frequency deviates from the 1,000 cycle value, the voltages across the two branches will become unequal and diode current will flow. The indicating meter reads the net diode current, and its scale is designed so that either positive or negative values can be observed depending upon whether or not the carrier frequency increases or decreases from its assigned value.

In order to obtain the highest degree of accuracy independent of normal line voltage and RF input fluctuations, it is necessary to maintain a constant current in the discriminator network. To accomplish this a three stage amplifier is employed between the crystal oscillator and the mixer tube, the gain of which is rigidly controlled by AVC voltage obtained from the discriminator circuit.



A V-cut crystal having an extremely low temperature coefficient is employed in the oscillator circuit. Two heat boxes, one inside the other, are incorporated for maintaining the temperature constant to a very high degree. The crystal is located in the inner heat box. The temperature of this compartment is controlled by a mercury fixed-adjustment thermostat. The outer box contains the oscillator circuit components and its temperature is controlled in the same manner as that of the inner box. Watchmen thermostats are included in addition so that the operation remains protected even in the event of failure of one of the primary thermostats. By means of this system the temperature of the inner box is controlled to within .05 degrees Centigrade.

The large front panel meter, in addition to indicating frequency deviation, is used for making all initial adjustments. Three control knobs for setting RF input level, 1,000 cycle level, and zero diode current are located on the panel underneath the meter. A push button is provided for each control knob and the circuits are so arranged that when a button is pressed, the meter is switched to the proper part of the circuit for making the desired reading.

#### Specifications:

Frequency range.....	.540 to 2000 KC
RF input level.....	less than 1 volt required
Crystal Oscillator Stability.....	better than 2 parts per million
Size.....	standard rack width; 15¾" in height
Weight.....	.96 lb.
Power Supply.....	105-125 volts, 50-60 cycles
Power Consumption.....	165 watts

# A-F & R-F MEASURING EQUIPMENT

## FIELD STRENGTH INSTRUMENTS

### 308-A BROADCAST FIELD INTENSITY METER

### Description

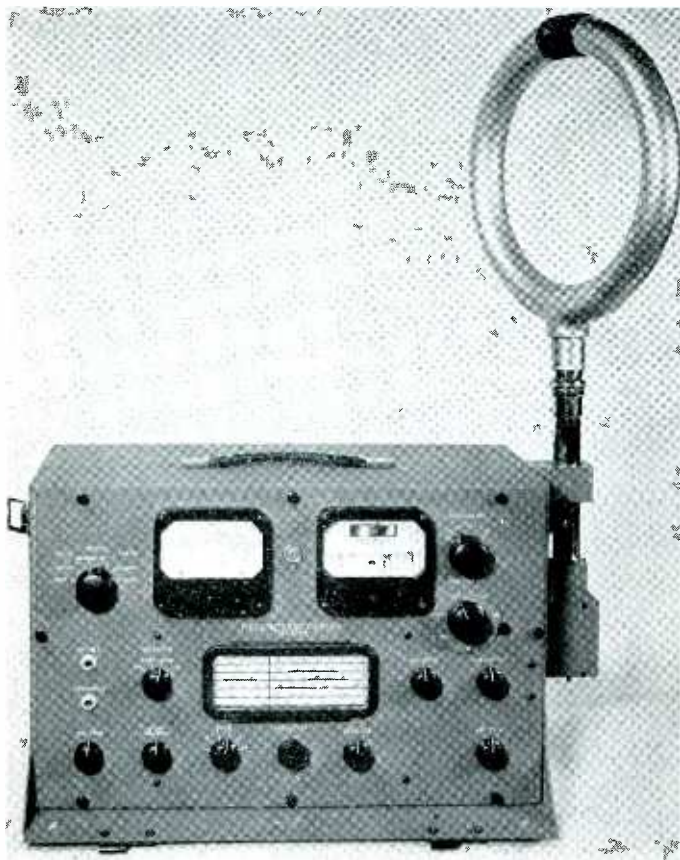

The 308-A operates on the principle of comparing the voltage induced in the shielded loop with the voltage generated by a self-contained calibrated oscillator. The oscillator voltage is inductively coupled into the loop circuit. Two attenuators are incorporated in the RF and IF circuits for setting levels. One consists of four capacity sections in series, each section providing an attenuation of ten to one—thus a total of 10,000 is possible. This attenuator is connected between the loop and the grid of the first mixer stage. Such an arrangement necessitates the first detector being linear over only a ten to one range, a distinct advantage where a high degree of accuracy is desired. The second attenuator is of the mutual inductance type and is included in the first IF stage. This attenuator is variable over a ten to one range and is adjustable by means of a dial which is calibrated directly in microvolts per meter. The scale is logarithmic. The indicating meter in the instrument reads the diode current in the second detector.

The calibrated oscillator tuning condenser, the beat oscillator tuning condenser, and the loop tuner are ganged on one control. Trimmers are provided for fine adjustments of the loop circuit and the calibrated oscillator.

In making a measurement the station is tuned in, the voltage from the calibrated oscillator set, and the two attenuators are adjusted until the second detector diode circuit reads to a pre-determined value. The field strength can be ascertained directly from the attenuator settings. Since for each measurement the diode current is the same, the accuracy of the reading is independent of linearity of the second detector. Thus another source of error common in most existing field strength meters is eliminated in the RCA Type 308-A.

**T**HE 308-A is a new and greatly improved meter for the measurement of field intensities in the band between 120 kc. and 18 mc. The instrument fills the long awaited need of the broadcasting industry for a dependable portable meter, capable of accuracy to an advanced degree. It covers the wide range of field intensities from 20 microvolts per meter to 10 volts per meter.

One of the great conveniences of the 308-A is the fact that it is direct reading in microvolts per meter thus eliminating complicated calculations and facilitating surveys. It establishes a new standard of accuracy for field intensity measurements by eliminating several important sources of error.

The instrument is easily operated and is of an extremely rugged design, making it adaptable to the severe usage encountered in the field. Because of its simplicity it becomes an easy matter to make surveys, measure effective station coverage, select transmitter sites and check spurious harmonic radiation.

The 308-A is highly portable, being constructed in a light, durable, aluminum case. An auxiliary case containing the batteries may be supplied, and provision has been made for suspending this battery box on brackets under the meter proper. The instrument is also designed for operation with the RCA type 93-A Vibrator Power Supply.

**Features**—Wide range of field intensities permits measurements close to antenna or at distances beyond service range. Wide frequency range to measure harmonics of broadcasting stations, principal radio services. Easy to use because of direct reading in field intensity. Unusually precise because of—shielded loops, first detector worked over 10-1 range only, second detector current operated at constant value for measurements thus not dependent on linearity for accuracy, wide band, i.f., stable oscillator, cathode heater tubes free from voltage fluctuation effects. One loop covers broadcast band and to 3,000 kc. Operates recording meter, linear or logarithmic. Gauged tuning controls. Full metering. Adaptable power supplies.

### SPECIFICATIONS

Field Intensity Range . . . . .	Approx. 20 microvolts per meter to 10 volts per meter
Frequency Range . . . . .	120 to 18,000 kc.
Number of Bands . . . . .	6 (Complete broadcast band covered with a single loop)
Dimensions . . . . .	13½" x 13½" x 20¾"
Weight . . . . .	Approx. 40 lbs.
Dry Battery Box Dimensions . . . . .	Approx. 13½" x 16½" x 4"
Dry Battery Box Weight . . . . .	Approx. 30 lbs. with batteries
Alternate Power Supply . . . . .	93-A Unit described on page 90

# A-F & R-F MEASURING EQUIPMENT

## FIELD STRENGTH INSTRUMENTS

### U-H-F FIELD-INTENSITY METER Type 301-A



**Applications:** This field-intensity meter is capable of accurately measuring field strengths of stations operating in the range of 20 to 125 megacycles. Since its range includes the channels assigned to television and FM broadcasting, this instrument is of great utility in that field.

**Description:** The Type 301-A Field-Intensity Meter is essentially a superheterodyne receiver equipped with a calibrating oscillator and an output meter. The receiver circuit comprises the conventional heterodyne oscillator and first-detector stages; three i-f amplifier stages; and a combined second detector, automatic volume control, and d-c amplifier stage. A vacuum-type thermocouple is employed for measuring the output of the calibrating oscillator.

The accessory case illustrated below contains an adjustable doublet-type antenna, an insulated tripod, and thirty feet of transmission line. The tripod may be extended in height sufficiently to permit rotation of the antenna for any plane of polarization of transmission.

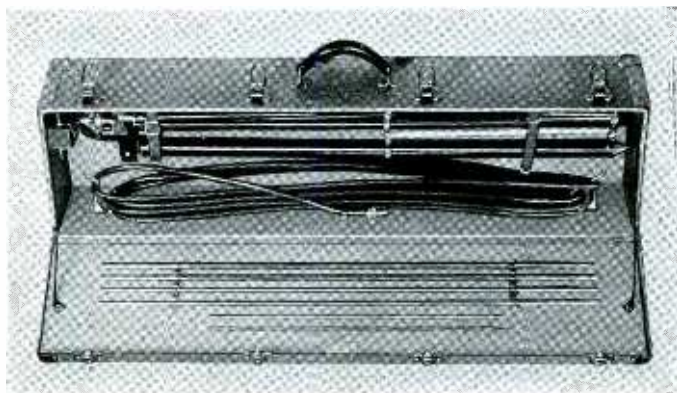

The 301-A, although primarily designed for measuring the field strength of an amplitude modulated station, can be used without change for making measurements on unmodulated FM carriers. By the simple process of changing a resistor and a condenser in the detector circuit, the instrument becomes applicable for use with FM transmitters even when being modulated. Instructions can be provided for making this modification.

**Features:** Coverage of exceptionally wide frequency and field-intensity ranges; choice of linear or logarithmic operation; provision for connection of a recorder to obtain field-intensity readings over periods of time; jack on panel permitting connection of headphones for audio monitoring, or a 302-A meter for determination of signal-to-noise ratio\*; doublet antenna and shielded transmission line, insuring excellent pick-up of high-frequency signals.

#### Specifications:

Frequency range (overall, 3 bands)..... 20 to 125 mc

Field-intensity range:

Low-frequency (20 mc)..... 10 to 500,000 microv per meter

High-frequency (125 mc)..... 50 to 2,500,000 microv per meter

Output scales:

Linear..... 10 to 1 or 20 db

Logarithmic..... 100 to 1 or 40 db

Output:

Audio..... operates phones or 302-A noise meter

Recorder... operates any recorder of 5 ma and 560 ohms, max.

Recommended antenna facilities..... Accessory Case, comprising:

(a) Antenna—Stainless steel, doublet type, consisting of one telescoping section on each side, covering entire frequency range down to 37.5 mc; and two fixed sections per side, utilized as extensions for lower frequencies down to 18 mc.

(b) Antenna Support—Bakelite tripod adjustable to 138 inches in height for supporting doublet antenna in any position.

(c) R-F Transmission Line—Two-conductor, shielded, rubber-covered wire, 30 feet in length.

Recommended power supply..... Type 93-A Vibrator Power Unit

Power requirements:

"A"..... 6 volts, 1.65 amperes

"B"..... 150 volts, 39 ma (max.)

Radiotrons..... 1 RCA-954, 2 RCA-955, 3 RCA-6K7, 1 RCA-6R7; total 7

Dimensions:	Height	Width	Depth	Weight
Meter (MI-7549).....	13"	20 $\frac{3}{8}$ "	9 $\frac{1}{4}$ "	38 lbs.
Accessory Case (MI-7548).....	12"	39"	7 $\frac{3}{8}$ "	24 lbs.

\* See page 100 for A. F. noise meter.

# A-F & R-F MEASURING EQUIPMENT

## FIELD STRENGTH INSTRUMENTS

### TYPE 312-A NOISE METER



**T**HE RCA TYPE 312-A NOISE METER is a light-weight portable unit designed to meet the demand for an instrument capable of measuring interference noises and other radiated voltages. Among its many applications are the measuring of noise produced by power lines and electrical appliances; comparative field strength measurements of radio signals; and for indicating the direction of the source of signals and interfering noises when used in conjunction with the Type 318-B Direction Finder Attachment.

#### DESCRIPTION

The 312-A is fundamentally a sensitive, super-heterodyne receiver equipped with an output metering system and a self-contained calibration source.

An R. F. amplifier, mixer-oscillator, and two stages of I. F. amplification are employed ahead of the second detector. The second detector is a linear diode employing a special time-constant circuit such that its output is an accurate approximation of the annoyance factor of noise voltages. (If these voltages are repeated at a very slow rate, the diode output is less than peak pulse value. Obviously, the "nuisance" factor is also less than if the repetitive rate were high.)

A switch is provided on the top panel of the instrument for changing this second detector time constant to one suitable for making field strength measurements.

Following the second detector is a single stage of DC amplification which drives an output meter equipped with a logarithmic scale.

The electron shot noise from a saturated diode is used as the source of calibrating voltage. This shot noise, in turn, has been calibrated in terms of a sine wave standard and is capable of maintaining accuracy to within  $\pm 15\%$  in accordance with the recommendations of the Joint Co-ordination Committee on Radio Reception.

The instrument is designed for use with a telescopic, two-meter, vertical antenna which plugs into a jack mounted on the top panel.

A telephone jack is provided to permit monitoring with a pair of headphones.

The instrument is designed for battery operation and

batteries capable of about 50 hours service are self-contained in the case.

The instrument complete with batteries weighs only 32 pounds and is extremely simple to operate.

A lid is provided for protecting the top panel during transportation. This lid also serves to carry the telescopic antenna and the headphones. A weather-proof carrying case is supplied for protection against inclement weather.

#### SPECIFICATIONS

Frequency Range: 150-350 KC, 540-18,000 KC.

Sensitivity: 10-100,000 microvolts per meter in three ranges.

Dimensions: Height 13 $\frac{3}{4}$ ", Width 13 $\frac{3}{4}$ ", Depth 9 $\frac{1}{4}$ ".

Weight: 32 pounds complete.

### ACCESSORIES FOR THE 312-A

#### TYPE 317-A LINE NOISE NETWORK

For measuring noise voltages existing on low voltage power lines, the 317-A network is available. This network consists of a resistance-capacity circuit and is suitable for use on lines where the potential is no more than 300 volts.

#### TYPE 317-B

#### SINGLE PHASE NETWORK

The measurement of noise voltages produced by single phase electrical appliances is made possible by means of the 317-B. This circuit consists of line filters and a suitable network for direct coupling to the 312-A Noise Meter.

#### TYPE 317-C SINGLE AND THREE-PHASE NETWORK

The 317-C is similar to the 317-B except that noise voltages generated by either single phase or three phase appliances may be measured.

◀ *The 312-A with the 318-B Direction Finder*



#### TYPE 318-B DIRECTION FINDER ATTACHMENT

This unit is designed for use with Type 312-A R. F. Noise Meter for indicating the direction of radio signals. It consists of a small loop antenna with switching arrangement to operate from 150 to 350 KC and 540 KC to 18 MC for bi-lateral measurements. When operated with a rod antenna, which is also provided, uni-lateral direction may be clearly indicated. The loop antenna operates from an azimuth dial scale or compass card, which may be adjusted to the north and south magnetic axis by means of a magnetic compass mounted within the loop antenna. Accuracy within two degrees is possible by means of this arrangement.

The attachment comprises a stage of RF amplification and a suitable coupling circuit for connection to the Type 312-A Noise Meter. The necessary battery complement is self-contained in the shielded metal case, dimensions of which are similar to those of the 312-A. Connecting links are provided for connection to the antenna and ground terminals of the noise meter. A weather-proof carrying case is also supplied with the 318-B.

# TELEVISION MEASURING EQUIPMENT

## FREQUENCY-RESPONSE AND PHASE-INDICATING UNITS

### SQUARE-WAVE GENERATOR Type 350-A

**Applications:** This instrument generates square-wave signals for rapidly checking the transient characteristics of television video amplifiers, in conjunction with a suitable cathode-ray oscillograph.

**Description:** The Type 350-A Square-Wave Generator offers a choice of five square-wave output frequency ranges, as shown under "Specifications," permitting separation of the low- and high-frequency transient effects.

In addition to square waves, two sinusoidal voltages are also available (range 5). The 100-ke sine wave may be used for horizontal deflection of the oscillograph beam or for synchronizing the timing axis. The 10-mc signal may be applied to the grid of the cathode-ray tube to modulate the spot intensity, thus introducing marker dots on the pattern at time intervals of 0.1 microsecond.

**Features:** Wide range of square-wave output frequencies providing great flexibility of operation; two sine-wave outputs which may be used for synchronizing the oscillograph sweep and marking time intervals on the oscillograph pattern; regulated power supply assuring optimum performance irrespective of line-voltage fluctuations.

#### Specifications:

##### Outputs:

Range	Frequency	Wave Form	Voltage (Peak-to-Peak)	Source
1	3-50 cy.*	Square	0-20 v	Int. Osc.
2	50-60 cy.	Square	0-20 v	Power Supply
3	60 cy.-100 kc	Square	{ 0-20 v below 13 kc 0-3 v above 13 kc }	External
4	13 kc	Square	0-20 v	Int. Osc.
5	{ 100 kc 100 kc 10 mc }	Square	0-3 v	Int. Osc.
		Sine	0-50 v	
		Sine	0-50 v	

\*In seven steps providing approx. frequencies of 3, 5, 8, 12, 30 and 50 cycles.

##### Rise time:

100-ke square wave (Range 5) will rise from maximum negative to maximum positive potential in approximately 0.12 microsecond. At other frequencies, the square waves will rise in less than 0.01 period if output-voltage limits are not exceeded.

Power supply..... 105-125 volts, 50-60 cycles  
 Power consumption..... 120 watts  
 Radiotrons... 6 RCA-6C6, 1 RCA-6F7, 3 RCA-6J7-G, 2 RCA-6K7-G,  
 2 RCA-991, 1 RCA-2A3, 1 RCA-874, 1 RCA-80, 1 RCA-57;  
 total 18

Dimensions..... height 19¾", width 20½", depth 9¼"  
 Weight..... 44 lbs.

### VIDEO SWEEP OSCILLATOR Type 351-A

**Applications:** This instrument enables reproduction of the response characteristic of television video and other wide-range amplifiers on the screen of the Type 305-A Oscillograph, for visual investigation and rapid adjustment. It is suitable for use on television transmitters, and is sufficiently portable for field test work on television receivers. When a rectifier, such as the Type 353-A described on page 102, is employed, the Type 304-A Oscillograph may be used instead of the 305-A.

**Description:** The circuit of the Type 351-A Video Sweep Oscillator comprises a beat-frequency oscillator, equipped with a frequency modulator for sweeping the output frequency from maximum to minimum at a definite rate; and a marker oscillator which superimposes an interference pattern on the response curve at any desired position for locating values of frequency in the response curve.

**Features:** Two ranges of video output, giving unusual flexibility in adjustment of amplifier circuits; marker oscillator which provides direct frequency calibration on easy-reading, straight-line dial, permitting rapid location of any specific point in response curve; virtual freedom from distortion, insuring a high degree of accuracy; electronically regulated power supply, rendering the instrument independent of line-voltage variations.

#### Specifications:

Frequency Range:  
 Video— { Band 1 (linear)..... 100-5000 kc  
           { Band 2 (non-linear)..... 2000-7000 kc  
 Marker—Overall (8 bands)..... 100-25,000 kc

Output voltage, maximum:  
 Video..... approx. 0.2 volt  
 Marker..... approx. 0.1 volt

Output impedance:  
 Video..... 120 ohms  
 Marker..... 2000 ohms

Power supply..... 105-125 volts, 60 cycles  
 Power consumption..... 50 watts  
 Radiotrons.... 1 RCA-6K8, 1 RCA-6J7, 1 RCA-6C5, 1 RCA-1851,  
 2 RCA-874, 1 RCA-574; total 7

Dimensions..... height 19¾", width 20½", depth 9¼"  
 Weight..... 38 lbs.

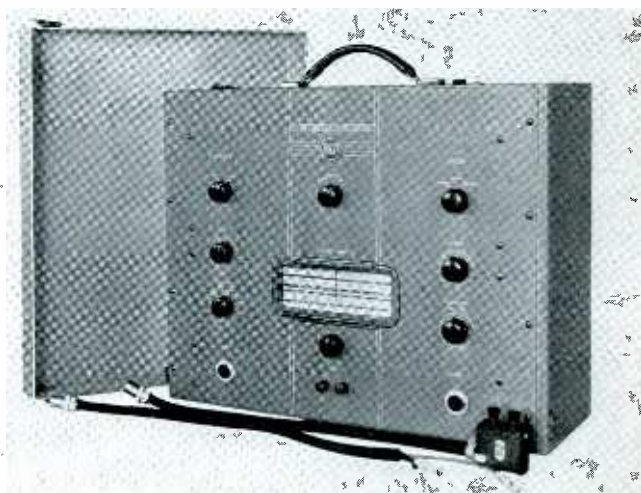

# TELEVISION MEASURING EQUIPMENT

## SYNCHRONIZING AND SWEEP APPARATUS

### R-F AND I-F SWEEP OSCILLATOR Type 352-A

**Applications:** The Type 352-A permits rapid oscillographic alignment of television circuits, studies of the sound and picture channels, and general studies of all types of transmission circuits within its frequency range. It can also be employed as a general-purpose frequency meter.

**Description:** This unit contains two r-f oscillators, one covering the range of 40 to 90 megacycles for r-f alignment and the other heterodyning with the former to provide a range of 8 to 13 megacycles for i-f alignment.

A marker oscillator permits superimposition of an interference pattern on the response curve at any point for frequency-measuring purposes.

**Features:** Marker oscillator calibration referred to 2-mc internal crystal insuring absolute accuracy; two sweep ranges enabling separate study of sound- and picture-channel i-f circuits; output voltage adjustable over wide range.

#### Specifications:

Frequency range (center of sweep)	
R-F.....	40-90 mc
I-F.....	8-13 mc
Sweep range	
R-F.....	8 mc (accurate at channel points)
I-F.....	8 or 1 mc
Output voltage.....	R-F, 0.1 volt (max.); I-F, 0.3 volt (max.)
Output impedance	
R-F.....	100 ohms (balanced)
I-F.....	75 ohms (unbalanced)
Marker oscillator:	
Frequency range.....	R-F, 37-105 mc; I-F, 4.2-16.8 mc
Modulation frequency (from audio oscillator).....	400 cycles
Crystal oscillator frequency (fundamental).....	2 mc
Power supply.....	105-125 volts, 60 cycles
Radiotrons.....	1 RCA-955, 1 RCA-954, 1 RCA-1851, 3 RCA-6C5 1 RCA-6J7, 1 RCA-5W4; total 8
Dimensions.....	height 19 $\frac{3}{4}$ ", width 20 $\frac{1}{2}$ ", depth 9 $\frac{1}{4}$ "
Weight.....	41 lbs.

### SWEEP RECTIFIER 353-A

A linear diode rectifier for checking response characteristics of wide-range amplifiers in conjunction with a sweep oscillator and cathode-ray oscillograph. This instrument, equally useful for single- or double-image operation, eliminates the need for a wide-range oscillograph for sweep-circuit applications.



#### Specifications:

Frequency range.....	100 kc to 150 mc
Voltage range.....	0.1-100 volts
Input circuit.....	25,000 ohms, 8 mmfd
Output circuit.....	250,000 ohms, 1,000 mmfd
Power supply.....	110-120 volts, 50-60 cycles
Power consumption.....	2 watts
Radiotrons.....	1 RCA-955
Dimensions.....	height 2 $\frac{1}{2}$ ", width 2 $\frac{7}{8}$ ", length 6 $\frac{7}{16}$ "
Weight.....	1 lb., 2 oz.

The Type 301-A U-H-F Field-Intensity Meter is a wide-range instrument covering all channels assigned to television broadcasting. Description on page 99.

### SYNCHRONIZING GENERATOR Type 560-A

**Applications:** This generator affords complete synchronizing signals for operation of television transmitters and receivers. It may be used on any 441-line system with a frame frequency of 30 and a field frequency of 60 (interlaced).

The 560-A has been so flexibly designed that it can easily be modified to generate and shape pulses for the production of pictures employing different numbers of lines and frames.

**Description:** Five different types of pulses are generated by a system of oscillators to accomplish iconoscope driving and blanking, and Kinescope blanking and synchronizing. The blanking pulses effect return-line elimination, the driving pulses actuate the deflection and other circuits, and the synchronizing pulses insure proper synchronization of television receivers. Circuits are also included to insure proper locking with the power-supply frequency.

The Type 561-A auxiliary rack recommended for operation of this generator contains two regulated plate-supply units of the 580-A Type\*, mounted in a cabinet rack.

**Features:** Special timing circuits maintaining extreme accuracy between leading edges of all pulses; improved locking circuit which synchronizes generator with 60-cycle power supply; conservative tube rating for long life.

#### Specifications of 560-A:

Power supply (Type 560-A):	110-120 volts, 60 cycles, 250 watts (Obtained through 561-A Rack)
Power supply (Type 561-A):	110-120 volts, 60 cycles, 850 watts
Power consumption (complete equipment):	1100 watts
Radiotrons:	

Type 560-A:.....	15 RCA-6F6, 6 RCA-6H6, 1 RCA-6K7, 5 RCA-6L6, 5 RCA-6L7, 30 RCA-6N7; total 62
Type 561-A:.....	4 RCA-VR-150, 4 RCA-5U1-G, 10 RCA-6Y6-G, 2 RCA-1852; total 20

Dimensions (both racks).....height 82 $\frac{7}{8}$ ", width 20 $\frac{5}{16}$ ", depth 14 $\frac{3}{8}$ "  
\*Type 580-A Plate Supply furnishes a potential of 300 volts d.c. for loads up to 400 ma. Description on page 90.

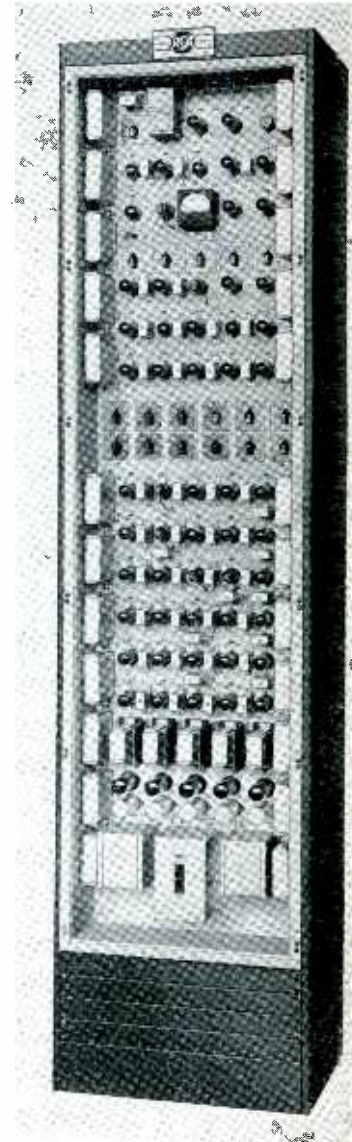

### TELEVISION TEST CHARTS

These charts permit precise measurements of resolution in all or any portion of the screen, and independent determination of horizontal and vertical resolution, upper-frequency cutoff, and quality of half-tone transmission. Also available on 35-mm. motion-picture film.

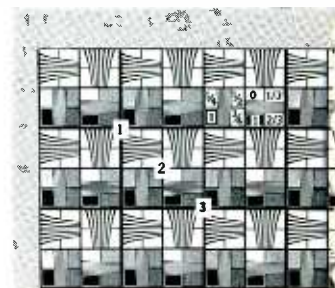

## Model AVA-37 Series

This series of crystals and crystal holders is a recent achievement of the RCA laboratories. This type provides all the benefits of the standard low-temperature-coefficient "V" cut quartz plate, plus the new feature of mounting this element within an hermetically sealed, gas-filled metal envelope. The benefits obtained are of paramount importance where reliability of operation and stability of performance are essential under adverse conditions of dust and humidity.

Since the crystal element is mounted in an airtight chamber filled with an inert gas, it is impossible for dust particles or moisture to come in contact with the crystal or its electrodes. This valuable feature insures remarkably long, trouble-free service, a requirement of particular importance in the aviation and police services. The complete unit

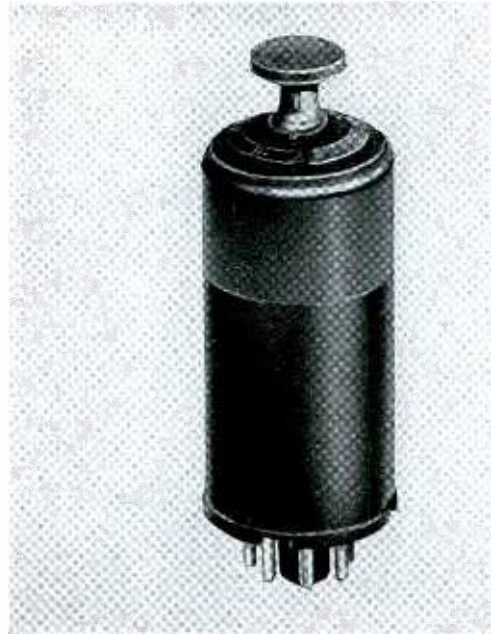

is small, no larger than an ordinary metal tube which it closely resembles, and is provided with a standard octal type base for mounting in an ordinary tube socket.

In this holder the crystal mounting is of the pressure air gap type, permitting the holder to be mounted in any position. The entire construction is extremely sturdy, amply able to withstand the most severe type of vibration or shocks liable to be encountered in any type of radio service. This holder has already been awarded a certificate of adoption by the Civil Aeronautics Board, and it is fully anticipated that this new type holder will be in great demand when its distinctive features are fully recognized, particularly in view of the low price made possible by quantity production.

This unit is manufactured in two frequency ranges. The model AVA-37 covers the frequency range of 1,715 Kc. to 10,250 Kc. Model AVA-37-A covers 10,250 Kc. to 20,000 Kc.

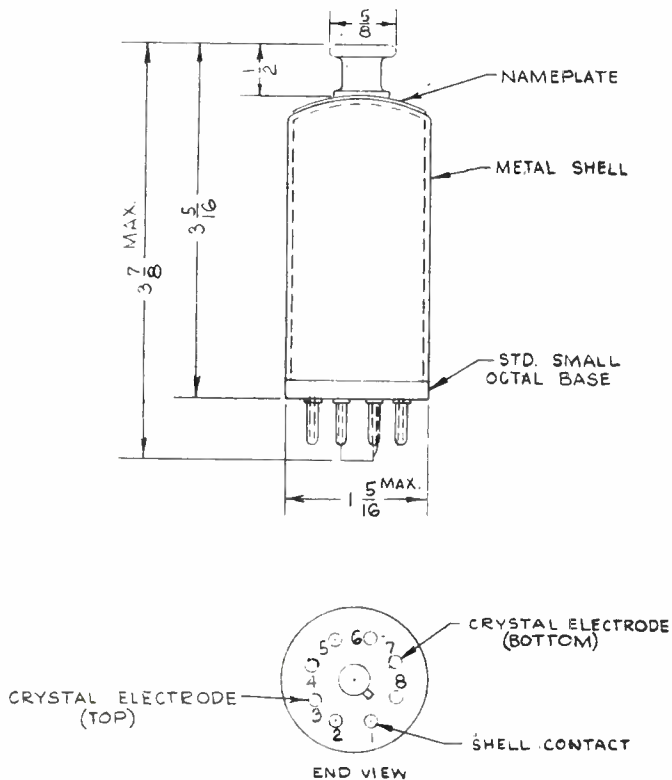

## Model AVA-53 Series



THIS AVA-53 series has been developed within the past year to provide a small, light-weight crystal holder unit similar to the RCA AVA-10 series for use in compact equipment where the decreased weight and volume are very important factors. This new unit weighs less than one half as much as the AVA-10 type, yet maintains all the advantages of the larger unit, employing as it does precisely the same type and size of electrodes and "V"-cut crystal. The crystal mounting is of the pressure-air gap type with (pressure) adjusting screw sealed against tampering after final test.

The AVA-53-A units are designed for use with crystals whose frequencies are between 1715 and 10,250 Kc, and the AVA-53-B holders are for the higher frequency band between 10,250 Kc and 20,000 Kc.

These holders have been especially designed to withstand the severe requirements encountered in aircraft service, as borne out by actual experience with thousands of holders over several years. All of the desirable features of the RCA AVA-10 series has been retained.

The AVA-53 series are dust and moisture proof and contain non-corrosive electrodes. This, together with the ability to withstand severe vibration and shock, makes them particularly desirable for use in mobile and marine equipment.

The weight of the AVA-53 series is 2.25 ounces and this, combined with the small size, makes this series a very popular model for use with modern receivers and transmitters where weight and compactness are very important design considerations. They are particularly suitable for use in aircraft receivers and transmitters and a large quantity is now being used in Aviation services.

These holders have passed the tests of the Civil Aeronautics Board and the AVA-53-A unit has been awarded approval No. 238 and the AVA-53-B unit has been awarded approval No. 239. These units meet all requirements for use in schedule airline radio equipment.

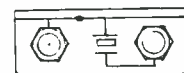
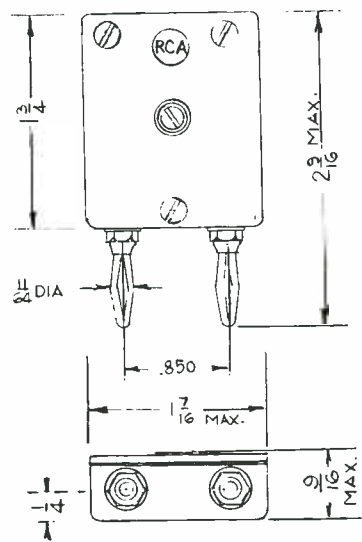

END VIEW SCHEMATIC



## Model AC-95 Series

The RCA type AC-95 crystals and crystal units were designed to function in the low frequency range between 200 Kc. and 400 Kc. The crystals employed in this series, as in the others, are "V" cut low temperature-coefficient plates.

The holder bodies are of ceramic steatite. Monel metal bottom plates serve as the lower electrodes and each is connected to the lower of two side terminals, which are one-half inch long by five-sixteenths inch in diameter. The upper side terminal is connected internally to the top electrode.

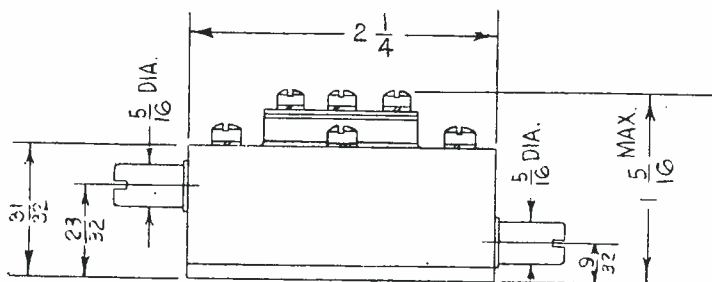
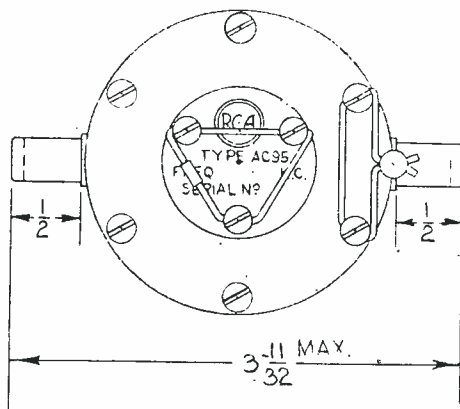
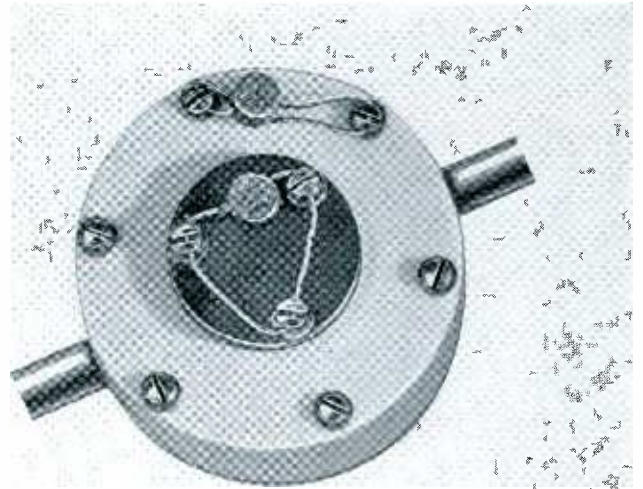

The AC-95-A holder has the same external appearance as the AC-95, but internally is designed to provide a pressure air gap mounting for the "V" cut crystals which may thus cover the frequency range from 1,715 Kc. to 10,250 Kc., or even up to 20,000 Kc. if desired. The electrodes of this holder are made of nickel silver, similar to those employed in other RCA holders for this same frequency range.

In the AC-95-B holder the crystal mounting is of the fixed air gap type, the holder itself being of the same general appearance as the two types just described, but differing in the size of nameplate on the top surface. This crystal unit is designed to cover a frequency range from 200 Kc. to 2,000 Kc.

## Models TMV-129-B and TMV-129-C

This series of crystals and crystal units is designed to provide frequency control for all transmitters operating in the frequency range from 200 Kc. to 3,000 Kc. It incorporates many patented features which provide a precision and quality of radio frequency control far in excess of the rigid requirements of the Federal Communications Commission for broadcast purposes. These units are widely used throughout the world and are particularly popular in the United States.

The 129-B holder is a shielded, self-contained unit of the plug-in type and contains a 15-watt, 115-volt heater element and a bi-metallic, compensated thermostat. The heater element and thermostat employed in this series are not just commercial articles adapted to a special application. On the contrary, the temperature control specifications of this holder are so rigid that RCA engineers have designed a special heater winding which surrounds

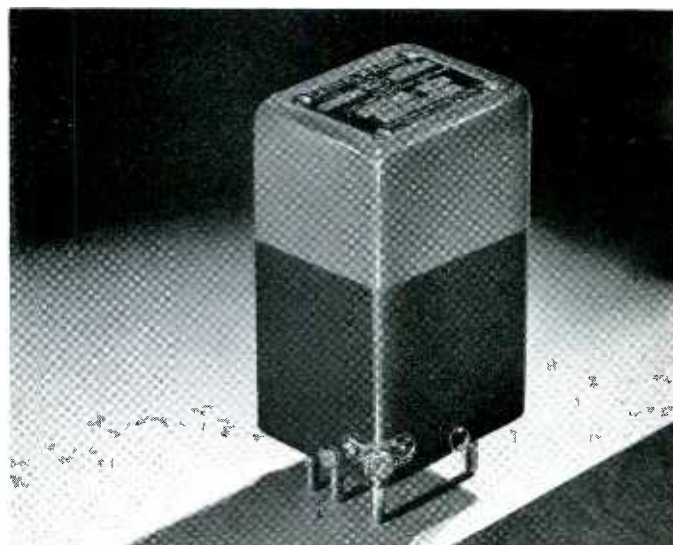

the crystal chamber on all four sides. It is very carefully insulated and shielded, and is energized directly from a 115-volt source (either A.C. or D.C.) through the controlling thermostat. The thermostat itself was especially developed for this application. No relays are used in this circuit, thereby reducing the liability of failure. The crystal temperature in the holder is maintained at 60 degrees Centigrade.

The crystal mounting is of the fixed air gap type and the electrodes are of low porosity monel metal. Connections to the two electrodes are brought out to two contacts of a special six-prong base which also provides connections to the metallic shields, heater winding and thermostat.

The RCA Type TMV-129-C differs from the TMV-129-B only in the type of crystal mounting employed. The pressure air gap type of mounting for use between 3,000 Kc. and 20,000 Kc. is used in the TMV-129-C. This type holder is a new product of RCA to extend all the benefits of the TMV-129-B throughout the high frequency range, thus providing precision frequency control up to twenty megacycles. In circuits employing the TMV-129-B or TMV-129-C, the thermostat should be shunted by a capacitor having a value of 0.0025 to 0.005 mfd's to provide longest life.

The material and workmanship of the TMV-129-B crystal unit is of such a high standard that RCA does not hesitate to guarantee that the assigned frequency will be maintained within ten cycles when used in the RCA UL-4292 oscillator.

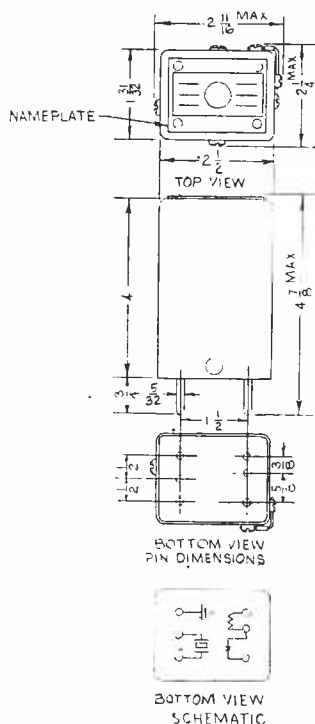

# Model TMV-135 Series

Amateurs have found these crystals and crystal holders excellently suited to their purposes. Commercial operators have also obtained excellent results with their use. This series is identical with the AVA-10 series, except that the two terminals are spaced three-fourths of an inch in accordance with standards set up for amateur use.

The holder body is of ceramic steatite, electrodes are of nickel silver and the crystal mounting is of the pressure air gap type. As in the more expensive type RCA holders, this unit uses the RCA "V" cut, low temperature coefficient crystals which are available for the 160, 80, 40, and the 20 meter amateur bands. Although primarily designed for amateur application, this holder is also extensively used for commercial purposes wherein the grinding tolerances and temperature-coefficient specifications are more rigid than required for amateur service.

The TMV-135 holders may be mounted in any position and may be used in a variety of oscillator circuits, so long as the radio frequency voltage and current do not exceed the guarantee ratings. Each crystal is carefully tested for accuracy, activity and stability before it is sealed into its holder.

The TMV-135-C is identical with the TMV-135-E, except for the electrodes and the crystal. In the higher frequency ranges special crystals are employed and differently shaped electrodes are used to provide maximum output. High quality at low cost is provided in this series of crystals and crystal units.

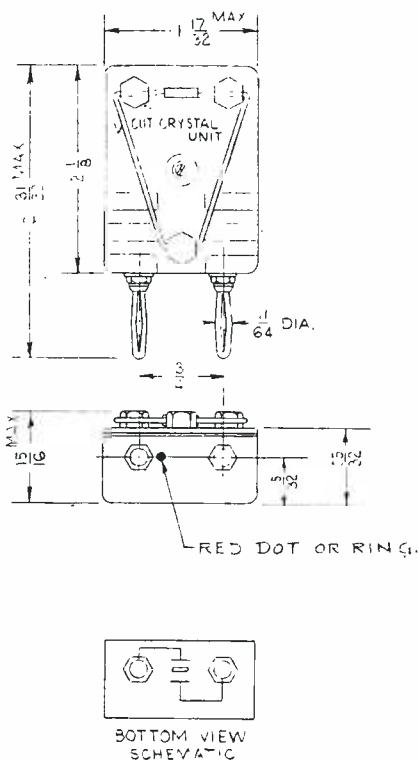

## Model TMV-135-R Series



THE importance of this special type of the TMV-135 series requires that a whole page be devoted to its description. This holder was developed to meet the demands for a crystal unit of small size, without any heater element but having a fixed air gap construction for precision frequency control in the low frequency range extending from 375 Kc to 1715 Kc. Due to the fixed air gap construction wherein the quartz crystal is not clamped, it is necessary that this unit be mounted horizontally, and for this reason the two plugs usually found in the TMV-135 holder body are replaced by two end brackets so that the holders may be securely mounted. The small bracket is connected internally to the lower crystal electrode and the opposite bracket forms the corresponding connection to the upper electrode.

Very carefully selected and finished RCA "V"-cut quartz plates are used in the TMV-135-R crystal holders, providing very active and exact frequency control units. For maximum precision these holders may be mounted in heater ovens wherein the temperature is maintained practically constant.

The advantages offered by this crystal holder assembly will be more generally appreciated by stating that this crystal mounting and the crystal itself are comparable to the corresponding units of the TMV-129B which is so universally used for frequency control in Broadcast Transmitters. When operated at a reasonably uniform temperature the frequency control will be exceptionally accurate, even without an external heater. In this case the actual frequency deviation is limited by the temperature coefficient of the quartz crystal, which may be as small as one and one-half cycles per megacycle per degree centigrade.

This TMV-135-R crystal unit is another example of a product designed for a special application, which proved so satisfactory that it has been standardized for commercial use.

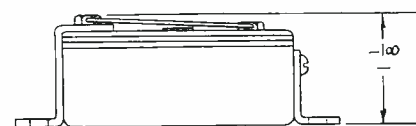
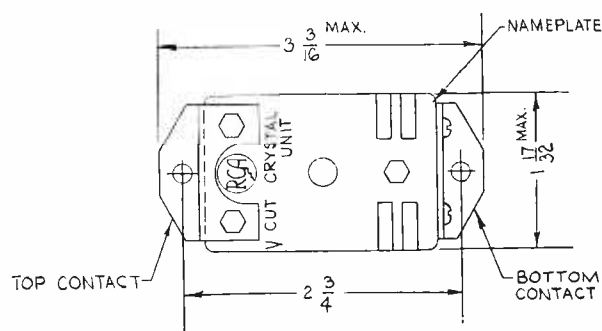

## Crystals and Holders for Special Applications

A recent development of the RCA Manufacturing Company, of prime importance to the manufacturers of superheterodyne receivers, is the production of crystal units for intermediate frequency resonators or high frequency oscillators. These units are the product of years of crystal research and manufacturing experience. Stability and a high "Q" factor are the most important characteristics of these units. Other outstanding features are their performance and simplicity.

These holders consist essentially of two similar moulded sections with a quartz crystal plate inserted as the two halves are placed together and sealed. For intermediate frequencies the pocket formed by sealing the two moulded halves of the body together is just large enough to permit the

crystal freedom of motion in any direction, whereas for high frequency oscillators the crystal plate is mounted in spring clips within the holder body.

The complete units are so small and light that they may be mounted securely by the two leads which form the connections or by their electrode extensions. In performance, the use of RCA "V" cut quartz plates in these sealed holders provides high-quality, inexpensive crystal units, free from frequency "jumps" or "creeps."

Special types of crystal holders are constantly being designed and manufactured for special applications, and RCA will welcome the opportunity to submit designs and recommendations for crystals, crystal holders or complete units for any application in transmitters, receivers or test equipment.



*One of the Many Types of Crystals Developed  
by RCA for Special Applications.*

# SPECIFICATIONS OF STANDARD CRYSTALS AND HOLDERS

Type	Frequency Range	Temperature Range	Accuracy Combined Grinding Tolerance & Temp. Coeff.	Heater	Electrodes	CRYSTAL Mounting
AVA-10	1.715 Kc.—7.500 Kc.	0° C.—+50° C.	Within 0.01%* of specified freq.	None	Nickel Silver	Pressure Air Gap
AVA-10-II	7.500 Kc.—20.000 Kc.	0° C.—+50° C.	Within 0.01%* of specified freq.	None	Nickel Silver	Pressure Air Gap
AVA-10-D	1.715 Kc.—7.500 Kc.	-40° C.—+55° C.	Within 0.015%** of specified freq.	None	Nickel Silver	Pressure Air Gap
AVA-10-E	7.500 Kc.—20.000 Kc.	-40° C.—+55° C.	Within 0.015%** of specified freq.	None	Nickel Silver	Pressure Air Gap
AVA-11	1.715 Kc.—7.500 Kc.	-40° C.—+55° C.	Within 0.015%** of specified freq.	6/12 V. bi-metallic disc thermostat	Nickel Silver	Pressure Air Gap
AVA-11-B	7.500 Kc.—20.000 Kc.	-40° C.—+55° C.	Within 0.015%** of specified freq.	6/12 V. bi-metallic disc thermostat	Nickel Silver	Pressure Air Gap
AVA-11-C	7.500 Kc.—20.000 Kc.	-40° C.—+55° C.	Within 0.01%* of specified freq.	6/12 V. bi-metallic disc thermostat	Nickel Silver	Pressure Air Gap
AVA-37	1.715 Kc.—7.500 Kc.	-40° C.—+55° C.	Within 0.015%** of specified freq.	None	Nickel Silver	Pressure Air Gap
AVA-37-A	7.500 Kc.—20.000 Kc.	-40° C.—+55° C.	Within 0.015%** of specified freq.	None	Nickel Silver	Pressure Air Gap
AVA-53-A	1.715 Kc.—7.500 Kc.	-40° C.—+55° C.	Within 0.015%** of specified freq.	None	Nickel Silver	Pressure Air Gap
AVA-53-B	7.500 Kc.—20.000 Kc.	-40° C.—+55° C.	Within 0.015%** of specified freq.	None	Nickel Silver	Pressure Air Gap
AC-95	100 Kc.—2.000 Kc.	0° C.—+50° C.	As specified	None	Monel Metal	Adjustable Air Gap
AC-95-A	2,000 Kc.—7.500 Kc. 7.500 Kc.—20,000 Kc.	0° C.—+60° C.	Within 0.01%* of specified freq.	None	Nickel Silver	Pressure Air Gap
AC-95-B	100 Kc.—2,000 Kc.	0° C.—+50° C.	Within 0.01%* of specified freq.	None	Monel Metal	Fixed Air Gap
TMV-129-B	500 Kc.—2,000 Kc.	60° C. Maintained by thermostat and heater	Zero beat***	115 V. 15 W. thermostat A.C. or D.C.	Monel Metal	Fixed Air Gap
TMV-129-C	2,000 Kc.—20,000 Kc.	60° C. Maintained by thermostat and heater	As ordered depending on type of service	115 V. 15 W. thermostat A.C. or D.C.	Nickel Silver	Pressure Air Gap
TMV-135-C	1.715 Kc.—7,500 Kc.	0° C.—+50° C. For commercial use, or +10° C.—+50° C. For amateur use	Within 0.01%* of specified freq. for commercial use or within 0.1%* for amateur use	None	Nickel Silver	Pressure Air Gap
TMV-135-E	10,250 Kc.—20,000 Kc.			None	Nickel Silver	Pressure Air Gap
TMV-135-R	150 Kc.—2,000 Kc.	0° C.—+50° C.	Within 0.01%* of specified freq.	None	Monel Metal	Fixed Air Gap
M1-8097	1,600 Kc.—4,500 Kc.	0° C.—+50° C. or -40° C.—+50° C.	Within .1%*	None	Silver	Molecular Adhesion

\*Grinding tolerance only. \*\*Grinding tolerance and temperature coefficient.

\*\*\*Zero beat implies that the crystal is calibrated in the actual circuit in which it is to be used. For this, a trimmer condenser is used for fine adjustment of frequency. The usual temperature coefficient is 1.5 cycles per million per degree Centigrade, or less.

*Faradon*

# CONDENSERS



Type 352 Case  
Type 351 Case



Type 111 Case



Type 99 Case



Type 77 Case

THE RCA MANUFACTURING COMPANY offers a complete line of Faradon mica power condensers. Many of the most generally used types and those used in RCA transmitters are carried in stock, ready for immediate delivery. Other types are partially fabricated and may be assembled into finished units in a reasonably short time.

The well equipped laboratories of the RCA Manufacturing Company perform a very thorough and complete analysis of the various materials used in Faradon condensers,—only the best grades of materials that have been carefully tested and approved are used.

These laboratories are also a proving ground for finished condensers and as a result of the persistent tests by RCA engineers and physicists, many valuable and substantial improvements are continually being made.

Faradon condensers are of superior quality and render long and dependable service.



Type 140 Case

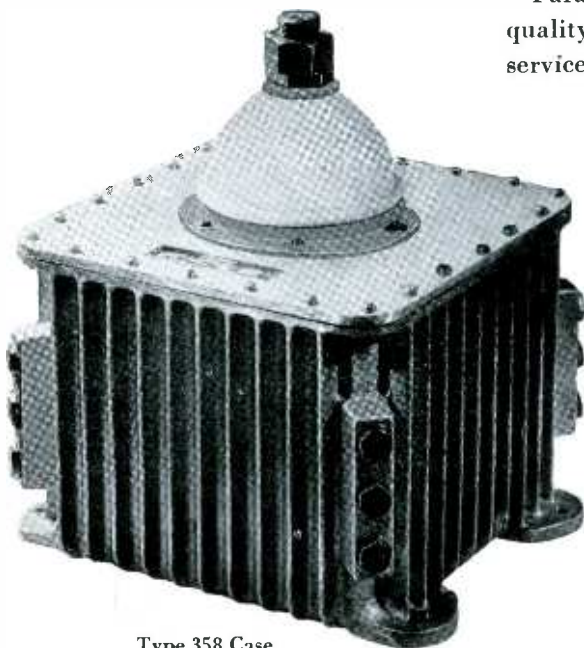

Type 358 Case



Type 13B Case



Type 361A Case

# Faradon

## DIMENSIONS OF STANDARD TYPES OF CAPACITOR CASES

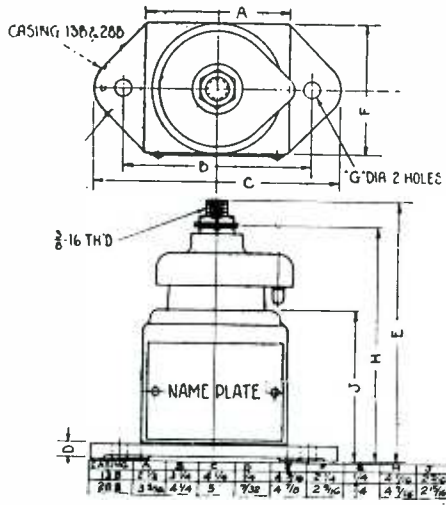

STANDARD FARADON condensers are listed on the succeeding pages; and condensers that are regularly carried in stock are marked with an asterisk.

Early models of condensers that are not shown in this listing may be supplied for replacement.

Dimensions of standard cases are shown on the adjoining drawings.

The following definitions are given in order to clarify the specifications included in the listing of standard condensers.

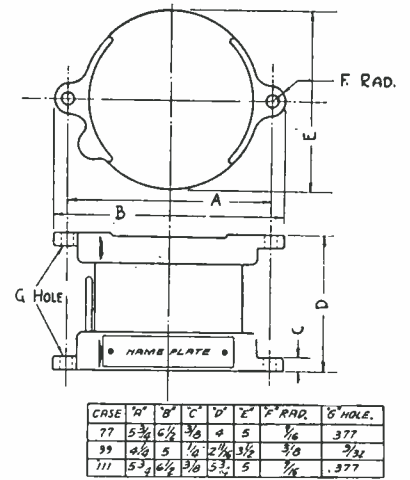

**CAPACITY:** The electrostatic capacity is stated in microfarads, accurate within a tolerance of plus or minus 5%.

**REACTANCE:** To assist engineers to select the proper capacity condenser, the reactance is given.

**CURRENT:** The current specified is the maximum for normal operation at ambient temperatures up to 60° centigrade. In modulated circuits assuming 100% modulation by a single audio frequency, the total current of 1.225 times the unmodulated current should not exceed the normal current rating of the condenser. By ambient temperature is meant the temperature of the air in the immediate vicinity of the condenser.

**VOLTAGE:** The maximum operating voltage is specified in terms of 60 cycles effective (RMS) or DC voltage. When two or more potentials are superimposed on a condenser the sum of all voltages should never exceed the rated voltage.

**GUARANTEE:** Faradon condensers are guaranteed against defective materials and workmanship for a period of 90 days. Authorization to return condensers for inspection and repair may be obtained from RCA Manufacturing Co., Camden, N. J. A report of operating conditions and reasons for returning must accompany the condenser.

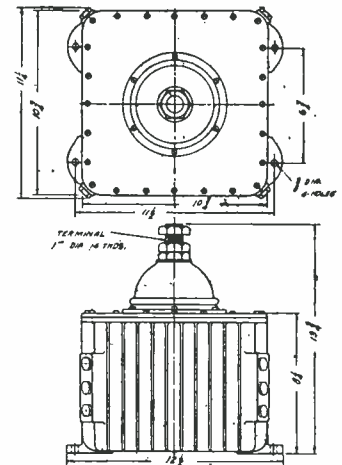
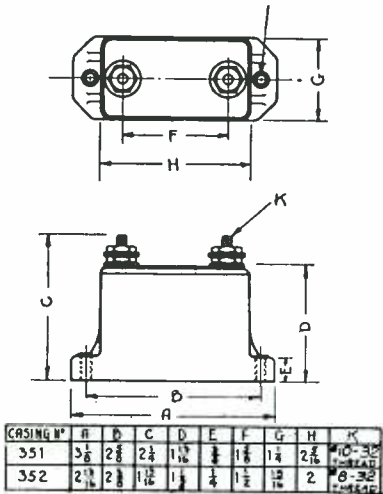

Casing 358

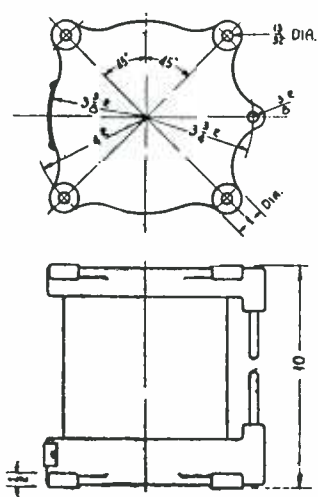

Casing 140

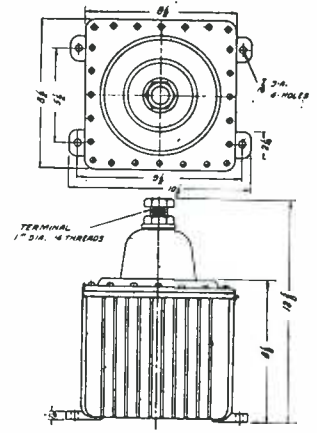

Casing 361A



# Faradon

## SPECIFICATIONS OF STANDARD MODELS OF MICA CAPACITORS

Capacity Microfarad	UC Model	Type Case	60 Cy. Eff. Voltage	Current Ratings		
				3000 Kc.	1000 Kc.	300 Kc.
1.0	Reactance.....			.053 ohms	.16 ohms	.53 ohms
	2979	111	1000	35 amps.	60 amps.	45 amps.
.5	Reactance.....			.11 ohms	.32 ohms	1.1 amps.
	2478	77	1000	25 amps.	60 amps.	40 amps.
.25	Reactance.....			.21 ohms	.64 ohms	2.2 ohms
	2980	351	250	16 amps.	20 amps.	16 amps.
	2981	99	1000	20 "	45 "	42 "
.1	Reactance.....			.53 ohms	1.6 ohms	5.3 ohms
	*2983	352	250	11 amps.	12 amps.	10 amps.
	2984	351	750	16 "	20 "	15 "
	2985	13B	1000	20 "	40 "	30 "
	2986	99	1000	20 "	40 "	35 "
	2988	77	2000	25 "	60 "	40 "
	3233	361A	6000	90 "	90 "	90 "
	3245	358	10000	100 "	100 "	100 "
.05	Reactance.....			1.1 ohms	3.2 ohms	10.6 ohms
	2989	352	500	11 amps.	10 amps.	8 amps.
	*2990A	351	1500	14 "	17 "	13 "
	2991	13B	1500	18 "	35 "	25 "
	2992	99	2000	20 "	40 "	35 "
	2446	77	3000	25 "	50 "	40 "
	2994	111	4000	35 "	60 "	45 "
	3234	361A	10000	90 "	90 "	90 "
	3246	358	15000	100 "	100 "	100 "
.02	Reactance.....			2.7 ohms	8.0 ohms	26.5 ohms
	2995	352	1000	11 amps.	10 amps.	7 amps.
	*2996	351	2000	14 "	15 "	11 "
	2997	13B	3000	18 "	21 "	16 "
	2998	99	3000	20 "	35 "	24 "
	2373A	77	3000	25 "	65 "	35 "
	3000	111	5000	35 "	60 "	42 "
	3235	361A	15000	90 "	90 "	90 "
	3247	358	20000	100 "	100 "	100 "
.01	Reactance.....			5.3 ohms	15.9 ohms	53.1 ohms
	3202	352	2000	10 amps.	14 amps.	7 amps.
	*3004	351	2000	14 "	14 "	9 "
	3005	13B	3000	18 "	22 "	15 "
	*3006	99	4000	20 "	28 "	18 "
	2551A	77	6000	25 "	45 "	25 "
	3008A	111	10000	30 "	50 "	31 "
	3009A	140	15000	50 "	75 "	45 "
	3236	361A	20000	90 "	90 "	86 "
	3248	358	25000	100 "	100 "	96 "

\* Stock Item

# Faradon

## SPECIFICATIONS OF STANDARD MODELS OF MICA CAPACITORS

Capacity Microfarad	UC Model	Type Case	60 Cy. Eff. Voltage	Current Ratings					
				3000 Kc.		1000 Kc.		300 Kc.	
.008	Reactance.....			6.6	ohms	19.9	ohms	66.3	ohms
	3011	352	1500	10	amps.	8	amps.	5	amps.
	3012	351	2000	13	"	12	"	7.5	"
	3013	13B	3000	18	"	20	"	13	"
	3014	99	4000	20	"	25	"	16	"
	3016	77	6000	25	"	36	"	22	"
	3017A	111	10000	30	"	42	"	27	"
	3018A	140	15000	65	"	65	"	40	"
	3237	361A	20000	90	"	90	"	76	"
	3249	358	25000	100	"	100	"	86	"
.006	Reactance.....			8.8	ohms	26.5	ohms	88.4	ohms
	3020	352	2000	9	amps.	7.5	amps.	4.5	amps.
	3021	351	3000	13	"	10	"	6.5	"
	3022	13B	5000	18	"	18	"	12	"
	3023	99	5000	20	"	23	"	14	"
	3025	77	6000	25	"	32	"	19	"
	3026A	111	10000	30	"	38	"	24	"
	3027	140	15000	45	"	60	"	36	"
	3238	361A	20000	90	"	90	"	66	"
	3250	358	25000	100	"	100	"	75	"
.005	Reactance.....			10.6	ohms	31.8	ohms	106	ohms
	*3029	352	2000	8.5	amps.	6.5	amps.	4	amps.
	3030	351	3000	12	"	9	"	6	"
	3031A	13B	5000	18	"	17	"	13	"
	3032	99	6000	20	"	21	"	13	"
	2663A	77	8000	30	"	30	"	20	"
	3034A	111	12000	35	"	36	"	22	"
	3035	140	15000	40	"	55	"	33	"
	3239	361A	20000	90	"	90	"	60	"
	3251	358	25000	100	"	100	"	68	"
.004	Reactance.....			13.3	ohms	39.8	ohms	133	ohms
	3037	352	2000	7	amps.	6	amps.	3.5	amps.
	*3038	351	3000	11	"	8.5	"	5.5	"
	*3039	13B	5000	17	"	15	"	9	"
	3040	99	6000	20	"	18	"	11.5	"
	*2360A	77	12000	27	"	27	"	16	"
	3042	111	15000	28	"	33	"	20	"
	3043	140	20000	35	"	50	"	30	"
	3240	361A	20000	90	"	90	"	52	"
	3252	358	30000	100	"	100	"	60	"
.003	Reactance.....			17.7	ohms	53.1	ohms	177	ohms
	*3045	352	2000	6.5	amps.	5	amps.	3	amps.
	3046	351	3000	10	"	8	"	5	"
	3047	13B	5000	15.5	"	13	"	8	"
	*3048	99	7000	20	"	16	"	10	"
	2374A	77	15000	22	"	25	"	16	"
	3050	111	15000	25	"	28	"	17	"
	3241	361A	20000	90	"	85	"	40	"
	3253	358	30000	100	"	96	"	52	"

\* Stock Item



SPECIFICATIONS OF STANDARD MODELS OF MICA CAPACITORS

Capacity Microfarad	UC Model	Type Case	60 Cy. Eff. Voltage	Current Ratings					
				3000 Kc.		1000 Kc.		300 Kc.	
.002	Reactance.....			26.5	ohms	79.6	ohms	265	ohms
	*3053	352	3000	5.5	amps.	4	amps.	2.5	amps.
	*3054	351	5000	8.5	"	6.5	"	4	"
	*3055A	13B	6000	13	"	10	"	6	"
	*3056	99	8000	16	"	14	"	8	"
	*2366	77	12000	21	"	20	"	12	"
	3222A	111	20000	22	"	22	"	13	"
	3198A	140	40000	40	"	38	"	21	"
	3242	361A	25000	65	"	65	"	30	"
	3254	358	30000	100	"	78	"	42	"
.0015	Reactance.....			35.4	ohms	106	ohms	354	ohms
	*3061	352	3000	5	amps.	3.5	amps.	2	amps.
	*3062A	351	5000	9	"	6	"	3.5	"
	3063	13B	5000	12	"	9	"	5	"
	3064	99	8000	14.5	"	11	"	7	"
	3066	77	12000	18	"	16	"	10	"
	*3067	111	16000	22	"	20	"	12	"
	3068A	140	40000	30	"	30	"	18	"
	3243	361A	25000	55	"	55	"	25	"
	3192A	358	30000	80	"	68	"	33	"
.001	Reactance.....			53.1	ohms	159	ohms	531	ohms
	*3070	352	3000	4.5	amps.	3	amps.	1.6	amps.
	*3071	351	5000	7	"	4.5	"	2.75	"
	3072	13B	5000	11	"	7	"	4	"
	*3073	99	10000	12	"	9	"	5.5	"
	*2325A	77	15000	16	"	16	"	9	"
	*3075	111	20000	18	"	17	"	10	"
	3076	140	40000	27	"	26	"	15	"
	3244	361A	25000	45	"	45	"	18	"
	3255	358	30000	60	"	55	"	22	"
.0008	Reactance.....			66.3	ohms	199	ohms	663	ohms
	3078	352	3000	4	amps.	2.5	amps.	1.5	amps.
	*3079	351	5000	6	"	4	"	2.5	"
	3080	13B	5000	9	"	6	"	3.5	"
	*3081	99	10000	11	"	8	"	5	"
	*2355A	77	20000	16	"	12	"	7	"
	*3083	111	25000	17	"	15	"	8.5	"
	3084	140	40000	26	"	24	"	13.5	"
.0006	Reactance.....			88.4	ohms	265.3	ohms	884	ohms
	3086	352	3000	3.5	amps.	2	amps.	1.2	amps.
	*3087	351	5000	5.5	"	3.75	"	2	"
	3088	13B	5000	8	"	5.5	"	3	"
	*3089	99	10000	10	"	7	"	4.25	"
	*2455	77	20000	12	"	10	"	6.5	"
	*3091	111	25000	14	"	12.5	"	7.5	"
	3092	140	40000	25	"	20	"	12	"

\* Stock Item

# Faradon

## SPECIFICATIONS OF STANDARD MODELS OF MICA CAPACITORS

Capacity Microfarad	UC Model	Type Case	60 Cy. Eff. Voltage	Current Ratings					
				3000 Kc.		1000 Kc.		300 Kc.	
.0005	Reactance.....			106	ohms	318	ohms	1061	ohms
	*3094	352	3000	3	amps.	2	amps.	1	amps.
	*3095B	351	5000	6	"	4	"	2	"
	3096	13B	5000	7.5	"	5	"	2.5	"
	*3097	99	10000	9	"	7	"	4	"
	*2344	77	20000	12	"	10	"	6	"
	*3099	111	25000	13	"	11	"	6.5	"
	3100	140	40000	25	"	18	"	10	"
.0004	Reactance.....			133	ohms	398	ohms	1326	ohms
	3102A	352	3000	3	amps.	2	amps.	1	amps.
	3103	351	5000	4.5	"	3	"	1.5	"
	3104	13B	5000	6.5	"	4.5	"	2.25	"
	*3105	99	10000	9	"	6.5	"	3.5	"
	*3106	77	20000	12	"	8.5	"	5	"
	*3107	111	25000	13	"	10	"	6	"
.0003	Reactance.....			177	ohms	531	ohms	1769	ohms
	3108	352	3000	2.5	amps.	1.5	amps.	.75	amps.
	*3109	351	5000	4	"	2.5	"	1	"
	3110	13B	5000	5.5	"	3.5	"	1.8	"
	*3111	99	10000	7.5	"	5	"	3	"
	*3112	77	20000	11	"	7	"	4	"
	3113A	111	30000	12	"	9	"	5	"
.0002	Reactance.....			265	ohms	795	ohms	2653	ohms
	3114	352	3000	2	amps.	1.2	amps.	.6	amps.
	*3115	351	5000	3.5	"	2	"	.7	"
	3116	13B	5000	4.5	"	3	"	1.2	"
	*3117	99	10000	6	"	4.5	"	2	"
	3118	77	20000	8	"	6	"	2.5	"
	*3119	111	30000	10	"	7	"	3	"
	2507	140	30000	18	"	12	"	4	"
.00015	Reactance.....			354	ohms	1061	ohms	3537	ohms
	*3120	352	3000	1.8	amps.	1	amps.	.45	amps.
	*3121	351	5000	3	"	1.5	"	.5	"
	3122	13B	5000	4	"	2.5	"	1	"
	3123	99	10000	6	"	4	"	1.6	"
	3124	77	20000	8	"	5	"	1.8	"
	*3125	111	30000	9	"	6	"	2.2	"
.0001	Reactance.....			531	ohms	1592	ohms	5306	ohms
	*3126A	352	3000	1.5	amps.	1	amps.	.3	amps.
	*3127A	351	5000	2.5	"	1.5	"	.5	"
	3128	13B	5000	3.5	"	2	"	.8	"
	*3129A	99	10000	6	"	3.5	"	1.5	"
	3130A	77	20000	7	"	4.5	"	1.7	"
	3131A	111	35000	8.5	"	5	"	2	"
.00005	Reactance.....			1061	ohms	3184	ohms	10612	ohms
	3132	352	3000	1	amps.	.5	amps.	.15	amps.
	3133	351	5000	1.3	"	.6	"	.18	"

\* Stock Item

# Faradon MODEL NF AND MODEL T CONDENSERS

MODEL NF and Model T Faradon Condensers are useful in transmitters for by-pass purposes in plate circuits, filament circuits and across meters as well as for plate or grid coupling condensers in low power circuits. They are not designed for dissipating large amounts of power but are arranged for low loss operation and will meet the rigid requirements of radio frequency service.



FARADON MODEL NF

FARADON MODEL NF Condensers are mica dielectric capacitors sealed in molded bakelite of the very best grade of compound (BM-262), properly cured in molding to insure low losses at radio frequencies, and very low moisture absorption. After molding they are aged, then tested for voltage rating and accurately measured for capacity and rated with a standard tolerance of  $\pm 10\%$ . Closer tolerances may be obtained at a slightly higher cost.

This condenser offers a very broad selection of mounting. It may be mounted flat with screws through angular slots in the molding compound, which provides a liberal variance between the centers of the mounting holes. There is also a clear air space between the condenser terminals and surface to which it is mounted. The condenser may also be mounted vertically and secured to base by means of two threaded holes in the molding compound. 6-32 screw terminals are provided for electrical connection, as well as solder tabs.



FARADON MODEL T

FARADON MODEL T condensers are mica dielectric capacitors built up of thin films of the best grade of clear mica and securely compressed between two metal compression plates eyeletted together. A special treatment is given to this condenser to seal it against moisture absorption and climatic temperature changes thereby maintaining constant accurate capacity under severe operating conditions.

Since the dielectric of this condenser is principally mica, it is particularly suitable for very high radio frequency operation, having very low power factor losses. Large, flat terminals, projecting from opposite sides of this condenser, permit a soldered connection to be made, avoiding the possibility of terminal resistance.

MODEL NF			Microfarad Capacity	MODEL T		
Price	DC Working Voltage	DC Test Voltage		DC Test Volts	DC Working Voltage	Price
.60	2500	5000	.00005	700	500	.40
.60	2500	5000	.0001	700	500	.40
.60	2500	5000	.0002	700	500	.40
.60	2500	5000	.0003	700	500	.40
.60	2500	5000	.0004	700	500	.40
.70	2500	5000	.0005	700	500	.50
.70	2500	5000	.0006	700	500	.50
.70	2500	5000	.0008	700	500	.50
1.00	2500	5000	.001	700	500	.60
1.00	2500	5000	.002	700	500	.60
1.00	2500	5000	.003	700	500	.70
1.00	2500	5000	.004	700	500	.70
1.40	1200	2500	.005	700	500	.75
1.70	1200	2500	.006	700	500	.75
1.70	1200	2500	.008	700	500	.85
1.70	1200	2500	.01	700	500	.85
.90	600	1000	.015			
1.40	600	1000	.02			
1.90	600	1000	.03			
Specify Type "BNF" Add .25 to above prices			Meter By Pass Terminals On Above Condensers	Specify Type "T4" Add .10 to above prices		

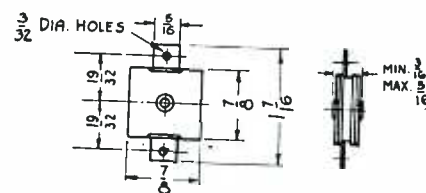
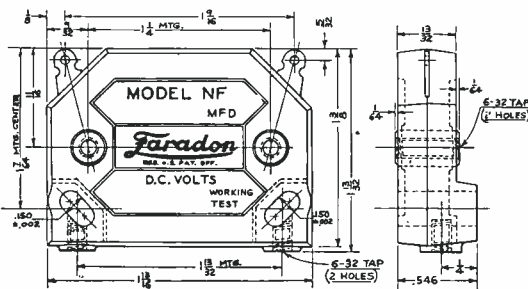

# Faradon HIGH FREQUENCY CONDENSERS

FARADON high frequency condensers are built in low capacities usually required for Television, Facsimile and other high frequency power equipments. These condensers are of sulphur dielectric, one of the best known dielectrics, selected because of its very low power losses, and capable of operating at comparatively high temperatures. Another

very desirable feature is the small space they occupy, in comparison with other types of condensers at equal load and voltage.

In listing these condensers, no frequency is specified. The values listed apply for any frequency provided none of the other maximum values are exceeded in operation.



Case 366



Case 367

## CASE 366

Model	MMFD Capacity	Max. KVA	Max. DC. or 60 cy. Eff. Voltage	Max. R. F. Eff. Voltage	Max. R. F. Current	Height "A" Dimen.
3287	20	50	20000	10000	10	4 <sup>3</sup> / <sub>4</sub> "
3288	40	60	20000	10000	15	5 <sup>5</sup> / <sub>8</sub> "
3260	50	75	20000	10000	20	6 <sup>1</sup> / <sub>2</sub> "
3289	60	75	20000	10000	20	6 <sup>5</sup> / <sub>8</sub> "
3290	80	75	15000	7500	20	6 <sup>1</sup> / <sub>2</sub> "
3291	100	75	15000	7500	20	7 <sup>1</sup> / <sub>2</sub> "

## CASE 367

UC-3292	20	30	10000	5000	8	2 <sup>11</sup> / <sub>16</sub> "
3286	30	30	10000	5000	8	2 <sup>7</sup> / <sub>8</sub> "
3278	40	40	10000	5000	10	3 <sup>3</sup> / <sub>8</sub> "
3204	50	40	10000	5000	12	3 <sup>7</sup> / <sub>8</sub> "
3294	60	40	10000	5000	12	4 <sup>3</sup> / <sub>16</sub> "
3295	80	50	10000	5000	15	4 <sup>3</sup> / <sub>4</sub> "
3296	100	50	10000	5000	15	5 <sup>11</sup> / <sub>16</sub> "
3297	120	50	10000	5000	15	6 <sup>1</sup> / <sub>2</sub> "

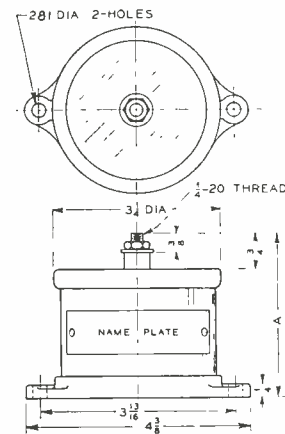
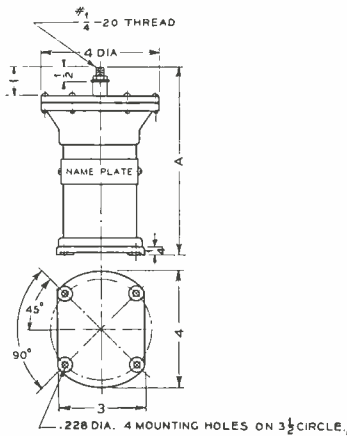



# TRANSMITTING AND SPECIAL PURPOSE TUBES

# RCA TRANSMITTING TUBES

An entirely new system of ratings for many RCA Air-Cooled Transmitting Tubes is now in effect. Instead of one set of maximum ratings for a tube, two are available. These ratings are designated CONTINUOUS COMMERCIAL SERVICE (CCS) and INTERMITTENT COMMERCIAL AND AMATEUR SERVICE (ICAS). Ratings for CCS are essentially the equivalent of former Maximum Ratings and are based on considerations of long tube life and maximum reliability of tube operation. ICAS ratings are considerably higher than CCS ratings. They permit the handling of much greater power but tube life under these conditions, of course, is reduced. However, since there are innumerable applications where the design factors of minimum size, light weight, and maximum power output are far more important than extremely long tube life, the transmitter designer may very properly decide that a small tube operated with ICAS ratings better meets his requirements than a larger tube operated with CCS ratings. The choice of tube operating conditions best fitted for any particular application should be based on a careful consideration of all features.

## AIR-COOLED TYPES

Type	Classification	Description	Max. Plate Volts	Max. Plate Input Watts	Max. Plate Dissipation Watts	Max. Freq.† Mc	Fil. (or heater) Volts
203-A	Triode	R-F Power Amplifier, Class B Mod.	1250	220	100	15	10.0
204-A	Triode	R-F Power Amplifier, Class B Mod.	2500	690	250	3	11.0
211	Triode	R-F Power Amplifier, Class A and B Mod.	1250	220	100	15	10.0
800	Triode	R-F Power Amplifier, Class B Mod.	1250	100	35	60	7.5
801-A	Triode	R-F Power Amplifier, Class A and B Mod.	600	42	20	60	7.5
802	Pentode	R-F Power Amplifier, Class A Mod.	500*	25*	10*	30	6.3
803	Pentode	R-F Power Amplifier	2000	350	125	20	10.0
804	Pentode	R-F Power Amplifier	1250*	120*	40*	15	7.5
805	Triode	R-F Power Amplifier, Class B Mod.	1500	315	125	30	10.0
806	Triode	R-F Power Amplifier, Class B Mod.	3000*	600*	150*	30	5.0
807	Beam	R-F Power Amplifier, Class AB <sub>2</sub> Mod.	600*	60*	25*	60	6.3
808	Triode	R-F Power Amplifier, Class B Mod.	1500	200	50	30	7.5
809	Triode	R-F Power Amplifier, Class B Mod.	750*	75*	25*	60	6.3
810	Triode	R-F Power Amplifier, Class B Mod.	2000*	500*	125*	30	10.0
811	Triode	R-F Power Amp., Class B Mod. (Mu = 160)	1250*	155*	40*	60	6.3
812	Triode	R-F Power Amp., Class B Mod. (Mu = 29)	1250*	155*	40*	60	6.3
813	Beam	R-F Power Amplifier	2000	360	100	30	10.0
814	Beam	R-F Power Amplifier	1250*	180*	50*	30	10.0
825	Inductive Output	U-H-F R-F Power Amplifier (For use above 300 Mc)	2000 •	100 •	50 •	—	6.3
827-R°	Beam	R-F Power Amplifier	3500	1500	800	110	7.5
828	Beam	R-F Power Amplifier, Class AB <sub>1</sub> Mod.	1250*	200*	70*	30	10.0
829	Beam	Push-Pull R-F Power Amplifier	500	120	40	200	6.3
830-B	Triode	R-F Power Amplifier, Class B Mod.	1000	150	60	15	10.0
832	Beam	Push-Pull R-F Power Amplifier	400	36	15	150	6.3
833-A	Triode	R-F Power Amplifier, Class B Mod.	3000*	1250*	300*	30	10.0
834	Triode	R-F Power Amplifier	1250	125	50	100	7.5
837	Pentode	R-F Power Amplifier	500	32	12	20	12.6
838	Triode	R-F Power Amplifier, Class B Mod.	1250	220	100	30	10.0
841	Triode	R-F Power Amplifier, Class B Mod.	450	27	15	6	7.5
842	Triode	Class A Modulator	425	12	12	—	7.5
843	Triode	R-F Power Amplifier, Class A Mod.	450	18	15	6	2.5
844	Tetrode	R-F Power Amplifier	500	15	15	15	2.5
845	Triode	Class A and Class AB <sub>1</sub> Mod.	1250	150	100	—	10.0
849	Triode	R-F Power Amplifier, Class A and B Mod.	2500	875	400	3	11.0
850	Tetrode	R-F Power Amplifier	1250	220	100	15	10.0
851	Triode	R-F Power Amplifier, Class A and B Mod.	2500	2500	750	3	11.0
852	Triode	R-F Power Amplifier, Class B Mod.	3000	300	100	30	10.0
860	Tetrode	R-F Power Amplifier	3000	300	100	30	10.0
861	Tetrode	R-F Power Amplifier	3500	1200	400	20	11.0
865	Tetrode	R-F Power Amplifier	750	45	15	15	7.5
889-R°	Triode	R-F Power Amplifier, Class B Mod.	8500	16000	5000	25	11.0
891-R°	Triode	R-F Power Amplifier, Class A and B Mod. (Mu = 8) (2-phase filament)	10000	15000	4000	1.6	11.0
892-R°	Triode	R-F Power Amplifier, Class B Mod. (Mu = 50) (2-phase filament)	12500	18000	4000	1.6	11.0
893-R°	Triode	R-F Power Amplifier, Class B Mod. (6-phase filament)	20000	70000	20000	5	10.0
1608	Triode	R-F Power Amplifier, Class B Mod.	425	40	20	45	2.5
1610	Pentode	Crystal Oscillator	400	9	6	20	2.5
1613	Pentode	R-F Power Amplifier	350	17.5	10	45	6.3
1614	Beam	R-F Power Amplifier	375	35	21	80	6.3
1619	Beam	R-F Power Amplifier, Class A and B Mod.	400	30	15	45	2.5
1623	Triode	R-F Power Amplifier, Class B Mod.	750*	75*	25*	60	6.3
1624	Beam	R-F Power Amplifier, Class AB <sub>2</sub> Mod.	600	54	25	60	2.5
1627	Triode	R-F Power Amplifier, Class B Mod.	2000*	500*	125*	30	5.0
1628	Triode	U-H-F R-F Power Amplifier	1000	50	40	500	3.5

## WATER-COOLED TYPES

207°	Triode	R-F Power Amplifier, Class B Mod.	15000	30000	10000	1.6	22.0
846°	Triode	R-F Power Amplifier	7500	7500	2500	50	11.0
858°	Triode	R-F Power Amplifier, Class B Mod.	20000	40000	20000	1.6	22.0
862°	Triode	R-F Power Amplifier, Class B Mod.	20000	200000	100000	1.6	33.0
880	Triode	R-F Power Amplifier, Class B Mod.	10500	60000	20000	25	12.6
887	Triode	U-H-F R-F Power Amplifier (Mu = 10)	3000	1200	1000	225	11.0
888	Triode	U-H-F R-F Amplifier (Mu = 30)	3000	1200	1000	225	11.0

†For tube operated at maximum rated plate voltage and plate input. • Value for collector.

°Sold only by Offices of RCA Manufacturing Company, Inc.

\*Continuous Commercial Service (CCS). In Intermittent Commercial and Amateur Service (ICAS), tube is operated at somewhat higher rating.



**WATER-COOLED TYPES (Continued)**

Type	Classification	Description	Max. Plate Volts	Max. Plate Input Watts	Max. Plate Dissipation Watts	Max. Freq. Mc	Fil. (or heater) Volts
889	Triode	R-F Power Amplifier, Class B Mod.	7500	15000	5000	50	11.0
891°	Triode	R-F Power Amplifier, Class A and B Mod. (2-phase filament) (Supersedes Type 848)	12000	18000	6000	1.6	11.0 per section
892°	Triode	R-F Power Amplifier, Class B Mod. (2-phase filament) (Supersedes Type 863)	15000	30000	10000	1.6	11.0 per section
893°	Triode	R-F Power Amplifier, Class B Mod. (3-phase filament)	20000	70000	20000	5	10.0 per section
898°	Triode	R-F Power Amplifier, Class B Mod. (6-phase filament)	20000	200000	100000	1.6	33.0 per section

**RECTIFIERS**

Type	Description	Max. Peak Inv. Volts	Max. Av. Plate Amp.	Fil. (or heater) Volts
217-A	Half-Wave, High-Vacuum	3500	0.20	10.0
217-C	Half-Wave, High-Vacuum	7500	0.15	10.0
836	Half-Wave, High-Vacuum	5000	0.25	2.5
857-B	Half-Wave, Mercury-Vapor (Supersedes Type 857)	22000	10.0	5.0
866	Half-Wave, Mercury-Vapor	7500	0.25	2.5
866-A	Half-Wave, Mercury-Vapor	10000	0.25	2.5
869-A	Half-Wave, Mercury-Vapor	20000	2.5	5.0
871	Half-Wave, Mercury-Vapor	5000	0.125	2.5
872	Half-Wave, Mercury-Vapor	7500	1.25	5.0
872-A	Half-Wave, Mercury-Vapor	10000	1.25	5.0
1616	Half-Wave, High Vacuum	5500	0.13	2.5

**TELEVISION TUBES**

**KINESCOPES**

Type	Description	Max. Anode Volts	Heater Volts
3AP4/906P4	3-Inch White-Phosphor Screen, Electrostatic Deflection	1500	2.5
5AP4/1805P4	5-Inch White-Phosphor Screen, Electrostatic Deflection (Short Bulb)	2000	6.3
5BP4/1802P4	5-Inch White-Phosphor Screen, Electrostatic Deflection	2000	6.3
7AP4	7-Inch White-Phosphor Screen, Magnetic Deflection (Short Bulb)	3500	2.5
9AP4/1804P4	9-Inch White-Phosphor Screen, Magnetic Deflection	7000	2.5
12AP4/1803P4	12-Inch White-Phosphor Screen, Magnetic Deflection	7000	2.5

**ICONOSCOPES AND ORTHICONS**

Type	Description	Max. Anode Volts	Heater Volts
1840	Orthicon for Direct and Film Pick-up Camera	300	6.3
1847	2-Inch Iconoscope for Amateur Television Camera	600	6.3
1848	Iconoscope for Portable Television Camera	1200	6.3
1849	Iconoscope for Film Pick-up Camera	1200	6.3
1850	Iconoscope for Direct Pick-up Camera	1200	6.3

**MONOSCOPES**

Type	Description	Max. Anode Volts	Heater Volts
1898	3-Inch, Electrostatic Deflection	1200	2.5
1899	5-Inch, Magnetic Deflection (High Resolution Capability)	1500	2.5

**RECTIFIERS**

Type	Description	Max. Peak Inverse Volts	Max. Plate Amp.	Max. Av. Plate Amp.	Fil. (or heater) Volts
2V3-G	Half-Wave, High-Vacuum	16500	0.012	0.002	2.5
2X2/879	Half-Wave, High-Vacuum	12500	0.100	0.0075	2.5
878	Half-Wave, High-Vacuum	20000	0.020	0.005	2.5
884	Gas Triode for Sweep-Circuit Control	300	0.30	0.003	6.3
885	Gas Triode for Sweep-Circuit Control	300	0.30	0.003	2.5

NOTE: For other tubes in Television Receivers, refer to RCA receiving tube lists.

**OSCILLOGRAPH TUBES**

Type	Description	Persistence	Max Anode Volts	Heater Volts
3A1P1/906-P1	3-Inch Green-Phosphor Screen, Electrostatic Deflection	Medium	1500	2.5
5BP1/1802-P1	5-Inch Green-Phosphor Screen, Electrostatic Deflection	Medium	2000	6.3
902	2-Inch Green-Phosphor Screen, Electrostatic Deflection	Medium	600	6.3
904	5-Inch Green-Phosphor Screen, Electrostatic-Magnetic Deflection	Medium	4600	2.5
905	5-Inch Green-Phosphor Screen, Electrostatic Deflection	Medium	2000	2.5
907	5-Inch Blue-Phosphor Screen, Electrostatic Deflection	Short	2000	2.5
908	3-Inch Blue-Phosphor Screen, Electrostatic Deflection	Short	1500	2.5
913	1-Inch Green-Phosphor Screen, Electrostatic Deflection	Medium	500	6.3
914	9-Inch Green-Phosphor Screen, Electrostatic Deflection	Medium	7000	2.5

Other Cathode-Ray tubes suitable for Oscillograph use are listed under TELEVISION TUBES (Kinescopes). Rectifiers and Sweep-Circuit Control Tubes for Oscillograph use are listed under TELEVISION TUBES (Rectifiers).

# PHOTOTUBES

Type	Description	Principal Use	Cathode Surface	Max. Anode Volts
868	Gas Phototube	Sound Reproduction	S1	90
917	Vacuum Phototube with Anode Cap	Relays and Measurements	S2	500
918	Gas Phototube (High Sensitivity)	Sound Reproduction	S2	90
919	Vacuum Phototube with Cathode Cap	Relays and Measurements	S2	500
920	Gas Phototube—Twin Type	Sound Reproduction	S1	90
921	Gas Phototube—Cartridge Type	Sound Reproduction	S2	90
922	Vacuum Phototube—Cartridge Type	Relays and Measurements	S2	500
923	Gas Phototube (High Sensitivity)—3 <sup>9</sup> / <sub>16</sub> " long	Sound Reproduction	S2	90
924	Gas Phototube—End Type	Relays	S1	90
925	Vacuum Phototube—2 <sup>5</sup> / <sub>8</sub> " long	Relays	S1	250
926	Vacuum Phototube—Cartridge Type	Colorimetry	S3	500
927	Gas Phototube—Miniature Type	Sound Reproduction	S1	90
928	Gas Phototube—Non-Directional Type	Relays	S1	90
929	Vacuum Phototube	Relays and Measurements	S4	250

# ACORN TUBES

Type	Classification	Description	Max. Plate Volts	Fil. (or heater) Volts	Fil. (or heater) Amp.
954	Pentode	U-H-F Amplifier, Detector	250	6.3	0.15
955	Triode	U-H-F Amplifier, Detector, Oscillator	180	6.3	0.15
956	Pentode	U-H-F Super-Control Amplifier	250	6.3	0.15
957	Triode	U-H-F Amplifier, Detector—Dry-Cell Type	135	1.25	0.05
958	Triode	U-H-F Amplifier, A-F Amplifier—Dry-Cell Type	135	1.25	0.10
959	Pentode	U-H-F Amplifier, Detector—Dry-Cell Type	135	1.25	0.05

# MISCELLANEOUS SPECIAL-PURPOSE TUBES

Type	Description	Cathode Type	Fil. (or heater) Volts
VR75-30	Voltage Regulator (75 volts, 5-30 Ma.)	Cold	—
VR105-30	Voltage Regulator (105 Volts, 5-30 Ma.)	Cold	—
VR150-30	Voltage Regulator (150 Volts, 5-30 Ma.)	Cold	—
864	Amplifier Triode (Low-Microphonic Type)	Filament	1.1
874	Voltage Regulator (90 Volts, 10-50 Ma.)	Cold	—
991	Voltage Regulator (48-67 Volts, 0.4-2.0 Ma.)	Cold	—
1602	Amplifier Triode (Low-Microphonic Type)	Filament	7.5
1603	Triple-Grid Detector, Amplifier (Low-Microphonic Type)	Heater	6.3
1609	Amplifier Pentode (Low-Microphonic Type)	Filament	1.1
1611	Power Amplifier Pentode, Uniform Cut-Off Feature	Heater	6.3
1612	Pentagrid Amplifier (Low-Microphonic Type)	Heater	6.3
1620	Triple-Grid Detector Amplifier (Low-Microphonic Type)	Heater	6.3
1621	A-F Power Amp. Pentode (For Applications Requiring Continuity of Service)	Heater	6.3
1622	A-F Beam Power Amp. (For Applications Requiring Continuity of Service)	Heater	6.3
1851	Amplifier Pentode (Transconductance = 9000 Micromhos)	Heater	6.3
2000	Low-Voltage Half-Wave, Gas Rectifier, Output 6 amperes	Filament	2.2
2050	Gas-Tetrode (For Relay Service, Max. Av. Anode Ma. = 100)	Heater	6.3
2051	Gas-Tetrode (For Relay Service, Max. Av. Anode Ma. = 75)	Heater	6.3

# TRANSMITTING TUBE ACCESSORIES

## SOCKETS, END MOUNTINGS AND WATER JACKETS

Type	Description
UT-102-A	Socket (for 803)
UT-103	End Mountings (for 833)
UT-104	Socket (for RCA 813)
UT-106	Socket (for RCA 829, 832 low r.f. or audio use)
UT-107	Socket (for RCA 829, 832 high r.f. use)
UT-541-A	Socket (50-watt size)
UR-542-A	Socket (7 <sup>1</sup> / <sub>2</sub> -watt size)
UT-1085-6	End Mountings (for 204-A, 849, 851, etc.)
UT-1285-A	Water Jacket (for 207, 848, 863, 891, 892)
UT-1289	Water Jacket (for 862-898) (Less mounting)
UT-4289	Mounting Insulator and Clamp (for UT-1285-A)
UT-4305	End Mountings (for RCA 857-B)

## GASKETS (LEAD RUBBER)

Type	Description
PX-1178	(For 207, 848, 863, 1652, 891, 892)
PX-1181	(For 862, 898)
PX-1281	(For 858)

## MISCELLANEOUS

(Stock No.)	Description
16679	Hose Nipples (for 207, 848, 863, 1652, 891, 892)
MI-7422-A	Outside Filament Connector (for 891, 892)
MI-7432	Center Filament Connector (for 891, 892)
Stock No. 16402	Filament Transformer for Scott connection (for 891, 892) (2 required per tube)

## OTHER RCA PRODUCTS

RCA products include a wide variety of apparatus used in nearly all forms of radio service and in kindred fields. While it is not possible to provide complete listings of all of the equipment for other applications, outlines of the various types of equipment have been given together with information as to where further data may be obtained.

The slogan "RCA ALL THE WAY" means more than merely a complete line of equipment in the broadcast transmitting and receiver field. It means a complete service for radio in all of its branches. These comprehensive facilities are exclusive with RCA. The resulting wide experience of RCA engineers in every radio application and the complete lines of equipment offered make it advantageous to go to RCA for radio apparatus of any sort.

# RCA AVIATION RADIO EQUIPMENT

RCA aviation radio equipment includes transmitters and receivers for either aircraft or ground station use, radio compass equipment and accessory apparatus. Advanced engineering and great manufacturing facilities provide efficient apparatus for private, commercial and military aircraft.

Typical of RCA high-efficiency apparatus is Model AVT-22 Multi-Channel, short-wave, radiophone and radiotelegraph transmitter. This equipment is a 2.5 KW or 5 KW, high-level modulated, crystal controlled transmitter designed for use in the Aeronautical, Point-to-Point, Marine and Shortwave broadcasting services. In its simplest form it is a 2.5 KW single-channel telephone or telegraph transmitter for use on any one frequency between 2.5 and 19 megacycles. By installing additional output tubes and accessories, the power output can be increased to 5 KW. The 5 KW model (designed as AVT-22A) is available from stock with conversions already made.

Either model may be expanded by adding any number of extra radio-frequency panels. The modulator-rectifier unit is common to all versions of the transmitter. One or two rf panels may be installed in the original rf cabinet. Any number of rf cabinets with panels can be installed as additional frequencies are required. The result is an effi-

cient, versatile and economical equipment for domestic or export use.

Model AVT-12B Aircraft Transmitter, is an outstanding example of flexible design. The transmitter is a 2-channel, 2-frequency telephone transmitter designed specifically for itinerant flyers. Frequencies of 3105, 3120, 6210 and 6240 KC can be obtained with only two crystals. The equipment will supply 50 watts phone or 90 watts CW on 2 channels, 4 frequencies. Model AVT-12B is designed for complete remote control—permitting placement of the various units in the most suitable locations with regard to best weight distribution.

Model AVR-7H Aircraft Receiver (CAATC No. 440) is a 3-band, 5-tube superheterodyne designed for use on the 200 to 410 KC (radio range, weather and traffic) band; the 500 to 1400 KC (standard broadcast) band and 2300 to 6700 (airline frequencies) band. Complete remote control including band change is provided. Provisions are also made for attaching Model AVA-56 Rotatable Loop Antenna for taking accurate bearings on the long wave band. Model AVR-7H is an ideal receiver for private or commercial aircraft of all sizes.

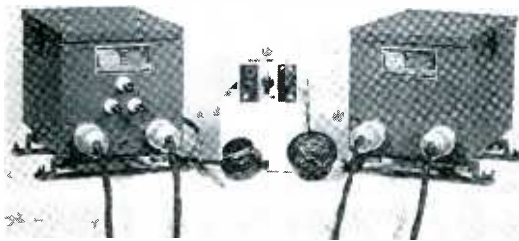

Left—View of AVT-7B Complete Transmitter Assembly.

Remote control panel of AVR-7H. Panel can be split so that mechanical and electrical controls can be mounted separately.

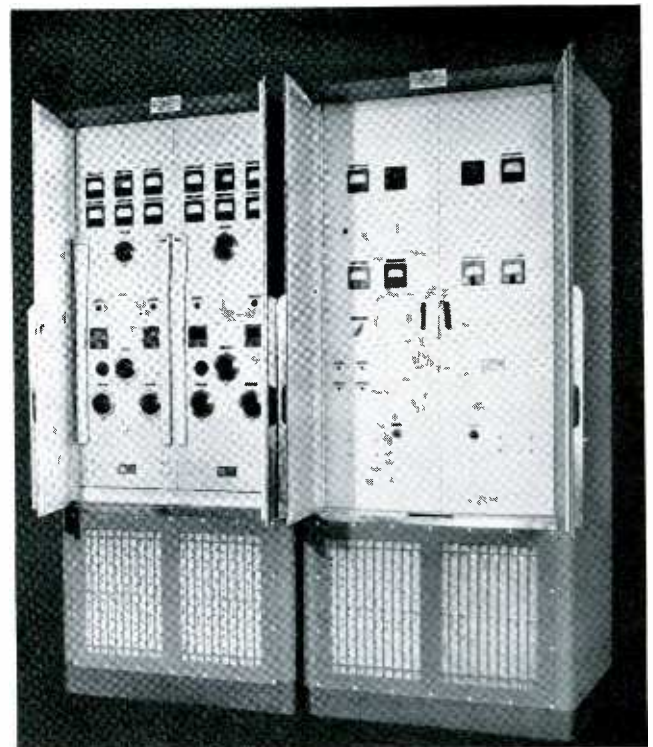

Modulator and RF units of AVT-22 Transmitter shown in normal operating position. RF panels (left) can be lowered to table height for ease of inspection. All components are unusually accessible.

# RCA POLICE RADIO SYSTEMS

**R**CA Police Radio Equipment furnishes a network of rapid communications to help preserve law and order. RCA equipment is used by more than 250 municipalities throughout the United States, including such outstanding installations as Cleveland, Miami and St. Paul, as well as in some seven states where radio is employed. The State of Michigan, for example, one of the pioneers in using radio as a police aid, is equipped with two RCA 5 KW. transmitters and one 1 KW. transmitter. Many of the smaller communities have depended on RCA's low power, ultra high frequency apparatus for years for communication with prowl cars. RCA equipment is also utilized by the Federal police agencies and RCA gun detector equipment is installed in a number of prisons to prevent smuggling of weapons.

The police radio line consists of conventional frequency apparatus operating in the band of 1610 to 2500 kilocycles and "Terrawave" ultra high frequency equipment. Conventional frequency transmitters can be supplied in the power range of 50 to 5000 watts. Receivers are also available for station house use, for car installations and for motorcycles. RCA conventional police band receivers feature rugged construction designed for hard service, crystal controlled oscillators to maintain tuning, economical vibrators and excellent sensitivity.

*MI-7824—22-watt mobile UHF transmitter — is operated from 6-volt battery. Features: Crystal Control, automatic Modulation Control, minimum size and weight.*



*MI-7818—highly selective mobile receiver—has built-in power supply. Features: Compactness, Easy Servicing, Selectivity, Efficient "Squelch" Circuit, Economical Stand-by Operation. Designated as MI-7819 when supplied for stationary AC operation.*

Terrawave equipment includes central station ultra high frequency transmitters from 25 watts up to 1000 watts, car talkback transmitters and both mobile and fixed receivers. The receiver line is designed to minimize ignition noise and to silence the receiver output except during transmission. Transmitters feature precision crystal control, high quality transmission and excellent electrical and mechanical design.

RCA Police Radio Equipment is sold by any special RCA representatives and installations are handled through an extensive nationwide service organization. RCA motorcycle receivers are designed specially for and sold through the Harley Davidson and Indian Motorcycle firms.

This line of police radio equipment is steadily growing in popularity and every year finds more and more communities turning to RCA for apparatus to aid their police departments in rendering more efficient and effective service.

# COMMERCIAL SOUND EQUIPMENT

**I**NCLUDED in the Commercial Sound line is a full series of public address equipment, both portable and for fixed use, audio distribution systems for hotels or schools, radio distribution systems for utilizing a common antenna in apartment houses, inter-office communication units and accessories. This apparatus has been designed by RCA engineers specifically for each purpose and the equipment is reasonably priced yet high in quality.

Among the popular, low priced portable public address systems is the PG-181, weighing only 25 lb. complete with loudspeaker and amplifier in a single carrying case. Rated at 6 watts output, it is convenient to carry and easy to set up. The PG-114C provides a greater output, 25 watts, and weighs but 65 lb. This unit is equipped with two speakers, the whole unit fitting into two carrying cases. Remote mixing for controlling stage microphones is provided. The intermediate PG-180 has an output of 12 watts.

Fixed type public address equipment may be obtained complete or in major component form. Systems from 6 watts to 200 watts output are stocked with appropriate speakers for indoor or outdoor use. For example, the MI-6256 sound projector will handle 100 watts with excellent fidelity.



*MI-6256 RCA Super Sound Projector  
for long distance projection of quality sound.*

*RCA  
Portable  
Sound  
System*



The RCA Multi-Wave Antenaplex System permits a common antenna to be used in a building with any number of outlets for receivers. It covers the range



*RCA Victor  
inter-commu-  
nicating system  
that requires  
no wires,  
MI-6350.*

of 530 to 18,000 KC. The RCA School Sound System provides audio distribution to classrooms for radio, records or voice announcements.

Inter-office communication units, (such as a pair of MI-6350 units) either for wire connection or for carrier over the power line are available. Broadcasting stations will find these useful for talking between transmitter and antenna tuning house or between offices. It is only necessary to plug two RCA Victor-Phones into the light sockets and communication is instantaneous.

Commercial Sound apparatus is sold through distributors in larger cities. A separate catalog of these products is available.

# PHOTOPHONE EQUIPMENT

RCA's "Magic Voice of the Screen" Photophone equipment is installed in more than 5,000 theatres in the U. S. A. and in numerous theatres throughout the world.

RCA Photophone recording equipment is used by film producers such as RKO, Columbia Pictures, Twentieth Century Fox, Warner Brothers, Pathe, Walt Disney, March of Time, and many others.

Photophone reproducing equipment is available for small theatre or for private exhibition rooms as well as for the largest auditoriums. Installations at the Radio City Music Hall in New York, and Grauman's Chinese Theatre in Hollywood, typify the larger class. Portable projector equipment and sound systems can also be obtained for private use or for commercial exhibitions.

For high fidelity reproduction of sound on film, RCA Photophone leads the way to "Sound Satisfaction."

Absolute proof of RCA's leadership in the recording and reproducing of sound on film was acclaimed to the world when the Academy of Motion Picture Arts and Sciences paid tribute to the world's finest sound by awarding RCA Photophone three of their coveted awards.



*MI-9210 Amplifier*

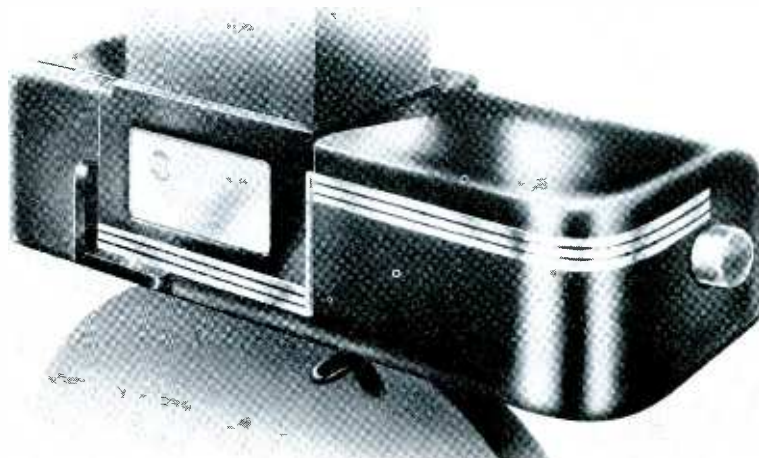

*MI-9050 Rotary Stabilizer Soundhead with Shockproof Drive*

# COMMUNICATIONS EQUIPMENT

RCA equipment for communications purposes is used by amateurs for friendly exchanges of messages, by those needing special transmission apparatus such as expeditions, foreign governments and for use where stringent broadcast performance is not required. The line of apparatus includes transmitters and receivers, among which are the following:

## AR-77 COMMUNICATION RECEIVER



The famous 10-tube AR-77 is one of the finest receivers ever offered for communication applications. It has all the worthwhile features essential for reliable operation under the most severe conditions. Frequency coverage is 540 to 31,000 kc. in six ranges with individual coils for each band. Band switching is employed. In the AR-77, RCA engineers have gone the limit in designing a receiver that provides the utmost in signal-getting ability, noise-free operation, stability, convenience, and economy.

High sensitivity, extreme frequency stability, and razor edge selectivity are but a few of the outstanding features that make this receiver a leader. Accurately calibrated 270° dials for the main tuning and band spread controls make it easy to find stations of known frequencies and to locate signals for future reference. The receiver is equipped with a carrier-level meter which is employed to assist in making peak tuning adjustments and measuring signal strengths. Rack mounting type also available.

## ACT-20 TRANSMITTER



The ACT-20 Transmitter employs a three stage r-f circuit of unique design that simplifies adjustment when changing coils and crystals. The ACT-20 has a power output rating of 16 watts for 'phone and 20 watts C.W. throughout the operating range of 1715 to 30,000 KC. The r-f tube complement is as follows: RCA 807 crystal-controlled oscillator, RCA 802 buffer/doubler, RCA 807 power amplifier operating "Class C." The audio complement comprises an RCA 6F5 speech amplifier, RCA 6F6 driver, and two RCA 6L6 modulators operating "Class B." The microphone input circuit is arranged for a double-button carbon microphone such as RCA Model MI-6225-A. The power supply is an integral part of the transmitter and employs two RCA-82 tubes for all rectified voltage requirements including the microphone. The entire transmitter is housed in a two-tone gray cabinet suitable for table mounting.

## ET-4331 GENERAL COMMUNICATIONS TRANSMITTER

This new RCA equipment is presented as a complete transmitter for broadcast and general communication purposes, operating in the frequency range of 3 to 20 megacycles. Provision is made for operation on any one of six frequencies. Although quality of transmission and low cost are the keynotes of this transmitter design, a number of features have been incorporated in this equipment to meet and exceed the most stringent requirements of today's broadcasters.

The cabinet frame is a fabricated structure of welded steel angles on a substantial base. The cross section of uprights is such as to provide rigidity and various assembly and service features. No moldings are required with this type of construction, the removable pieces being only the side screens and the chassis. The extreme simplicity of design enhances the pleasing appearance of the cabinet.

The equipment is divided into sub-assembled chassis. These are mounted in the cabinet through the rear doors, and slide on tracks which permit alignment at any elevation. Where the component parts require control from the front panel, the chassis and front panel may be an integral sub-assembly bolted in the cabinet at the front and bolted down to the tracks. The space between tracks and sides of cabinets allows circulation of air and may also be utilized for wiring.





# ET-4332-A COMMUNICATIONS TRANSMITTER



The RCA ET-4332-A Communications Transmitter is a High Fidelity Communications Equipment, designed in the modern manner and embodying the latest technical improvements to insure fine performance and economical operation. It is sturdily constructed for long life and employs quality-tested components throughout. In appearance it emphasizes clean lines, attractive color scheme and convenient arrangement of controls and meters. The flexibility of the ET-4332-A will recommend it particularly to Government telegraph administrations and communication companies.

The vertical chassis construction of the equipment provides easy accessibility to every part of the cabinet. Adjustments, tube changes and minor repairs are easily and quickly

made. Two large, low-loss, ceramic bushings are placed at the top of the cabinet for antenna feeder or transmission line connections. Two large cutouts have been made in the bottom for external wiring.

This fine example of RCA craftsmanship has been encased in a cabinet that is modern in style and pleasing in appearance. It is finished externally in two-tone umber gray, "orange-peel" finish with a zinc chromate undercoat. The inside is opalescent gray.

The transmitter is rated at better than 250 watts output and covers a frequency range of 2.2 megacycles to 20 megacycles. The transmitter may be set to any frequency in this range (for which a crystal is available) in a short time and with no difficulty.

# AR-67 COMMUNICATIONS RECEIVER

The AR-67 is a long wave receiver designed for commercial service and covering the band of from 75-1500 KC continuously. It is A.C. or battery operated and is arranged for C.W. or phone reception.

The superheterodyne circuit is employed with one r.f. stage, two i.f. stages with litz wound magnetite core transformers and two audio stages with push-pull output. The receiver is provided with a manual and automatic sensitivity control and C.W. heterodyne oscillator. Two degrees of selectivity may be obtained by means of auxiliary windings on the i.f. transformers for speech or telegraph reception. An output limiter is provided, variable and coupled to the volume control.

Nine tubes are employed although the use of dual purpose tubes provides the equivalent of 13. The receiver may be operated from external batteries (headphone re-

ception) using a 6 volt A battery and a 90 volt B battery or from an A.C. supply of 40-60 cycles, 110, 125, 150, 210 or 240 volts. Either cabinet or rack mounting may be supplied. The output is for a 600 ohm line, headphones or loudspeaker. Sensitivity is better than 5 microvolts for 50 milliwatts output.



Particular precautions have been taken to prevent damage from moisture or severe climatic conditions. In fact, in every respect, the AR-67 is a sturdy, reliable and sensitive communications receiver.

# AR-4291 TRANSCEIVER

This transceiver unit has been designed chiefly for portable communications purposes and is a sturdy unit weighing only fifteen pounds. It will operate in the range of 30-65 megacycles with an output of approximately 0.7 watts. The transceiver employs two tubes, an RCA-30 and an RCA-1F5G. With these tubes and with the standard batteries, a life of thirty hours continuous use will be obtained with one set of batteries.

The unit itself is approximately  $5\frac{7}{8}$ " x  $9\frac{1}{4}$ " x  $13\frac{1}{2}$ ". It contains a di-pole antenna. The range is covered by the use of two plug-in coils and mounting space is provided for the coil not in use. A filament voltmeter is mounted on the panel.

The unit is designed to operate on the same frequency for transmission and reception with compensation to assure that the same frequency will be employed for both modes of operation. Calibration curves are mounted inside of the lid to aid in tuning. The batteries employed consist of three Z-30PX 45 volt B batteries, two 4FH A batteries and one 5540 C battery (Burgess).

The unit is finished in gray wrinkle and is provided with a carrying strap for convenient use.

All parts are adequately protected when the unit is closed.



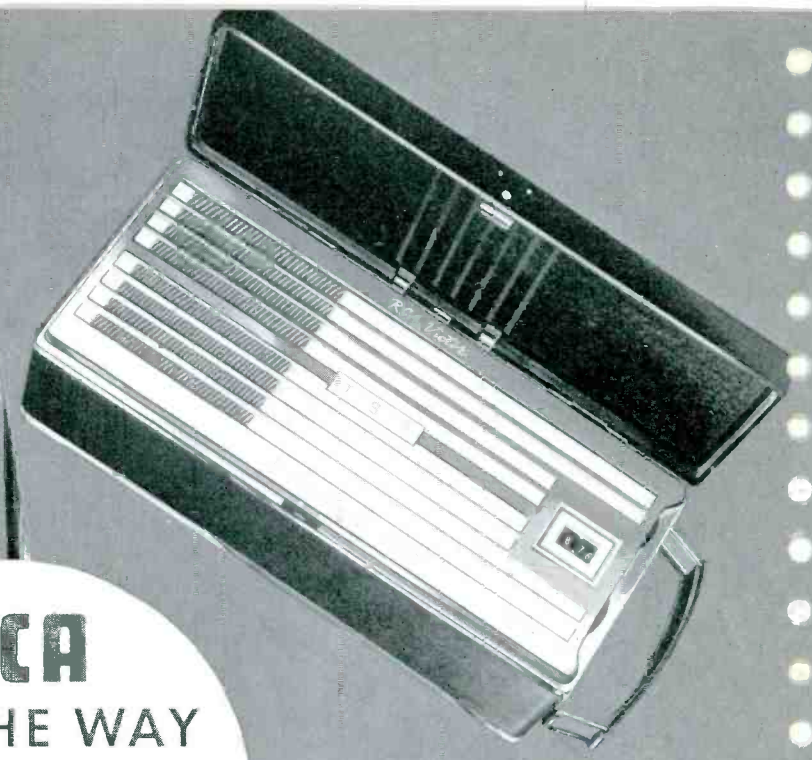

**RCA**  
**ALL THE WAY**  
 From the Microphone  
 in the Studio to the  
 Receiver in Your  
 Home



# DATA SECTION

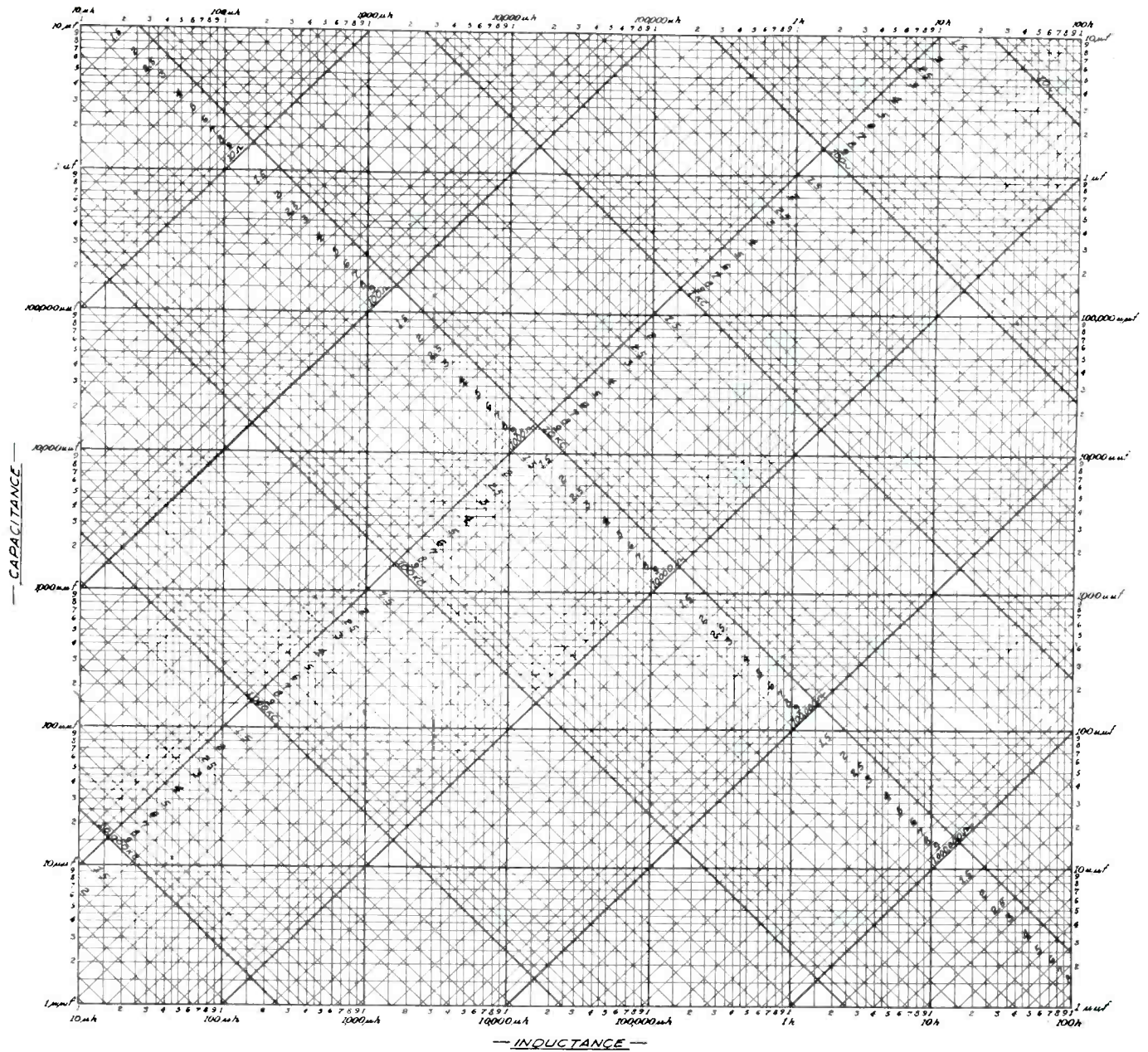

~~~~~ CHART OF FREQUENCY OR IMPEDANCE ~~~~~  
 ~~~~~ VS ~~~~~  
 ~~~~~ INDUCTANCE AND CAPACITANCE ~~~~~

| Impedance<br>Loss, dB | 600 Ohms            |                     | 600 Ohms            |                     | 600 Ohms            |                     | 600 Ohms            |                     | 600 Ohms            |                     | 600 Ohms            |                     | 600 Ohms            |                     |
|-----------------------|---------------------|---------------------|---------------------|---------------------|---------------------|---------------------|---------------------|---------------------|---------------------|---------------------|---------------------|---------------------|---------------------|---------------------|
|                       | R <sub>1</sub> Ohms | R <sub>2</sub> Ohms | R <sub>1</sub> Ohms | R <sub>2</sub> Ohms | R <sub>1</sub> Ohms | R <sub>2</sub> Ohms | R <sub>1</sub> Ohms | R <sub>2</sub> Ohms | R <sub>1</sub> Ohms | R <sub>2</sub> Ohms | R <sub>1</sub> Ohms | R <sub>2</sub> Ohms | R <sub>1</sub> Ohms | R <sub>2</sub> Ohms |
| 0                     | 0                   | ∞                   | 0                   | ∞                   | 0                   | ∞                   | 0                   | ∞                   | 0                   | ∞                   | 0                   | ∞                   | 0                   | ∞                   |
| 0.1                   | 1.79                | 50204               | 13.70               | 100500              | 3.60                | 100500              | 3.58                | 100500              | 7.2                 | 50000               | 3.58                | 100500              | 7.2                 | 50000               |
| 0.2                   | 3.41                | 20280               | 17.40               | 57380               | 6.85                | 57380               | 6.82                | 57380               | 13.8                | 26086               | 6.82                | 57380               | 13.8                | 26086               |
| 0.3                   | 5.16                | 17460               | 20.55               | 34900               | 10.28               | 34900               | 10.32               | 34900               | 21.0                | 17143               | 10.32               | 34900               | 21.0                | 17143               |
| 0.4                   | 6.90                | 13068               | 27.50               | 26100               | 13.80               | 26100               | 13.79               | 26100               | 28.2                | 12766               | 13.79               | 26100               | 28.2                | 12766               |
| 0.5                   | 8.60                | 10464               | 34.40               | 20920               | 17.20               | 20920               | 17.20               | 20920               | 35.4                | 10169               | 17.20               | 20920               | 35.4                | 10169               |
| 0.6                   | 10.45               | 8640                | 41.7                | 17230               | 20.85               | 17230               | 20.9                | 17230               | 43.2                | 8333                | 20.9                | 17230               | 43.2                | 8333                |
| 0.7                   | 12.1                | 7428                | 48.5                | 14880               | 24.25               | 14880               | 24.2                | 14880               | 50.4                | 7143                | 24.2                | 14880               | 50.4                | 7143                |
| 0.8                   | 13.75               | 6540                | 55.05               | 13100               | 27.53               | 13100               | 27.5                | 13100               | 57.6                | 6250                | 27.5                | 13100               | 57.6                | 6250                |
| 0.9                   | 15.51               | 5787                | 62.3                | 11600               | 31.2                | 11600               | 31.02               | 11600               | 65.4                | 5504                | 31.02               | 11600               | 65.4                | 5504                |
| 1.0                   | 17.25               | 5208                | 68.6                | 10440               | 34.3                | 10440               | 34.5                | 10440               | 73.2                | 4918                | 34.5                | 10440               | 73.2                | 4918                |
| 1.5                   | 25.9                | 3452                | 104.3               | 6950                | 52.1                | 6950                | 51.8                | 6950                | 113.4               | 3174                | 51.8                | 6950                | 113.4               | 3174                |
| 2.0                   | 34.4                | 2582                | 130.4               | 5232                | 60.7                | 5232                | 68.8                | 5232                | 155.4               | 2316                | 68.8                | 5232                | 155.4               | 2316                |
| 2.5                   | 42.9                | 2053                | 173.4               | 4195                | 87.7                | 4195                | 85.9                | 4195                | 200.4               | 1796                | 85.9                | 4195                | 200.4               | 1796                |
| 3.0                   | 51.3                | 1703                | 212.5               | 3505                | 106.2               | 3505                | 102.7               | 3505                | 247.8               | 1452                | 102.7               | 3505                | 247.8               | 1452                |
| 3.5                   | 59.6                | 1448                | 258.0               | 3021                | 143.8               | 3021                | 135.8               | 3021                | 297.6               | 1209                | 135.8               | 3021                | 297.6               | 1209                |
| 4.0                   | 67.9                | 1248                | 324.6               | 2651                | 182.3               | 2651                | 152.2               | 2651                | 351.0               | 1025                | 152.2               | 2651                | 351.0               | 1025                |
| 4.5                   | 76.1                | 1109                | 384.5               | 2365                | 214.1               | 2365                | 168.1               | 2365                | 407.4               | 883.7               | 168.1               | 2365                | 407.4               | 883.7               |
| 5.0                   | 84.1                | 987.6               | 445.9               | 2141                | 283.0               | 2141                | 184.0               | 2141                | 466.8               | 771.2               | 184.0               | 2141                | 466.8               | 771.2               |
| 5.5                   | 91.0                | 886.8               | 505.9               | 1956                | 342.8               | 1956                | 199.3               | 1956                | 530.4               | 678.7               | 199.3               | 1956                | 530.4               | 678.7               |
| 6.0                   | 99.7                | 803.4               | 567.6               | 1807                | 399.2               | 1807                | 214.6               | 1807                | 603.0               | 603.0               | 214.6               | 1807                | 603.0               | 603.0               |
| 6.5                   | 107.3               | 730.8               | 634.2               | 1679                | 453.0               | 1679                | 229.7               | 1679                | 679.8               | 539.8               | 229.7               | 1679                | 679.8               | 539.8               |
| 7.0                   | 114.8               | 685.2               | 704.4               | 1569                | 509.5               | 1569                | 244.2               | 1569                | 743.4               | 484.3               | 244.2               | 1569                | 743.4               | 484.3               |
| 7.5                   | 122.1               | 651.6               | 772.8               | 1475                | 568.3               | 1475                | 258.4               | 1475                | 822.6               | 437.6               | 258.4               | 1475                | 822.6               | 437.6               |
| 8.0                   | 129.2               | 627.6               | 842.2               | 1393                | 629.4               | 1393                | 272.3               | 1393                | 906.6               | 396.8               | 272.3               | 1393                | 906.6               | 396.8               |
| 8.5                   | 136.1               | 611.6               | 907.8               | 1322                | 693.3               | 1322                | 285.8               | 1322                | 996.6               | 361.2               | 285.8               | 1322                | 996.6               | 361.2               |
| 9.0                   | 142.9               | 595.0               | 979.8               | 1260                | 766.3               | 1260                | 298.9               | 1260                | 1091                | 329.5               | 298.9               | 1260                | 1091                | 329.5               |
| 9.5                   | 149.5               | 578.0               | 1054.1              | 1204                | 840.1               | 1204                | 312.0               | 1204                | 1191                | 302.2               | 312.0               | 1204                | 1191                | 302.2               |
| 10.0                  | 156.0               | 561.6               | 1139.8              | 1154                | 915.5               | 1154                | 326.1               | 1154                | 1297                | 277.5               | 326.1               | 1154                | 1297                | 277.5               |
| 11.0                  | 168.1               | 531.7               | 1231.7              | 1071                | 999.5               | 1071                | 339.1               | 1071                | 1393                | 253.5               | 339.1               | 1071                | 1393                | 253.5               |
| 12.0                  | 179.5               | 502.7               | 1317.7              | 1002                | 1082.3              | 1002                | 351.1               | 1002                | 1478                | 231.6               | 351.1               | 1002                | 1478                | 231.6               |
| 13.0                  | 190.3               | 474.8               | 1408.8              | 946.1               | 1174.8              | 946.1               | 363.5               | 946.1               | 1554                | 210.3               | 363.5               | 946.1               | 1554                | 210.3               |
| 14.0                  | 200.2               | 448.4               | 1504.4              | 899.1               | 1271.5              | 899.1               | 375.3               | 899.1               | 1631                | 190.4               | 375.3               | 899.1               | 1631                | 190.4               |
| 15.0                  | 209.4               | 424.4               | 1604.4              | 859.6               | 1373.3              | 859.6               | 386.8               | 859.6               | 1709                | 171.2               | 386.8               | 859.6               | 1709                | 171.2               |
| 16.0                  | 217.9               | 401.6               | 1708.1              | 826.0               | 1479.2              | 826.0               | 397.3               | 826.0               | 1788                | 153.0               | 397.3               | 826.0               | 1788                | 153.0               |
| 17.0                  | 225.7               | 379.3               | 1815.5              | 797.3               | 1588.8              | 797.3               | 407.8               | 797.3               | 1868                | 135.4               | 407.8               | 797.3               | 1868                | 135.4               |
| 18.0                  | 232.9               | 357.6               | 1927.8              | 772.8               | 1702.8              | 772.8               | 416.8               | 772.8               | 1949                | 118.0               | 416.8               | 772.8               | 1949                | 118.0               |
| 19.0                  | 239.5               | 336.4               | 2044.4              | 751.7               | 1821.5              | 751.7               | 425.5               | 751.7               | 2031                | 101.6               | 425.5               | 751.7               | 2031                | 101.6               |
| 20.0                  | 245.2               | 315.4               | 2166.6              | 733.3               | 1945.5              | 733.3               | 434.0               | 733.3               | 2114                | 85.4                | 434.0               | 733.3               | 2114                | 85.4                |
| 22.0                  | 255.9               | 255.9               | 255.9               | 703.6               | 2192.2              | 703.6               | 451.5               | 703.6               | 2302                | 66.6                | 451.5               | 703.6               | 2302                | 66.6                |
| 24.0                  | 264.4               | 209.2               | 269.2               | 680.8               | 2409.2              | 680.8               | 465.8               | 680.8               | 2497                | 51.7                | 465.8               | 680.8               | 2497                | 51.7                |
| 26.0                  | 271.4               | 163.4               | 292.7               | 663.4               | 2692.7              | 663.4               | 478.8               | 663.4               | 2700                | 38.6                | 478.8               | 663.4               | 2700                | 38.6                |
| 28.0                  | 277.0               | 118.8               | 317.8               | 649.7               | 2992.7              | 649.7               | 490.4               | 649.7               | 2912                | 28.3                | 490.4               | 649.7               | 2912                | 28.3                |
| 30.0                  | 281.6               | 77.9                | 343.2               | 639.2               | 3309.2              | 639.2               | 501.1               | 639.2               | 3131                | 20.3                | 501.1               | 639.2               | 3131                | 20.3                |
| 32.0                  | 285.3               | 42.4                | 369.2               | 630.9               | 3639.2              | 630.9               | 511.7               | 630.9               | 3356                | 14.6                | 511.7               | 630.9               | 3356                | 14.6                |
| 34.0                  | 288.3               | 15.1                | 394.4               | 624.4               | 4000.0              | 624.4               | 521.1               | 624.4               | 3587                | 10.0                | 521.1               | 624.4               | 3587                | 10.0                |
| 36.0                  | 290.6               | 18.98               | 419.3               | 619.3               | 4394.0              | 619.3               | 525.5               | 619.3               | 3824                | 7.65                | 525.5               | 619.3               | 3824                | 7.65                |
| 38.0                  | 292.5               | 15.11               | 443.3               | 615.3               | 4800.0              | 615.3               | 529.5               | 615.3               | 4066                | 6.06                | 529.5               | 615.3               | 4066                | 6.06                |
| 40.0                  | 294.1               | 12.00               | 467.1               | 612.1               | 5220.0              | 612.1               | 533.1               | 612.1               | 4312                | 5.0                 | 533.1               | 612.1               | 4312                | 5.0                 |

Attenuator Networks.

RESISTANCE CHART FOR "H" PAD ATTENUATOR 500/500 OHMS

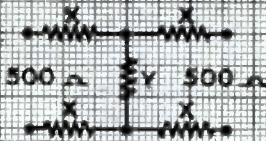

FOR 250/250 OHM PAD USE 1/2 OF X AND Y RESISTANCE VALUES OBTAINED FOR 500 OHM PAD

FOR "T" PAD

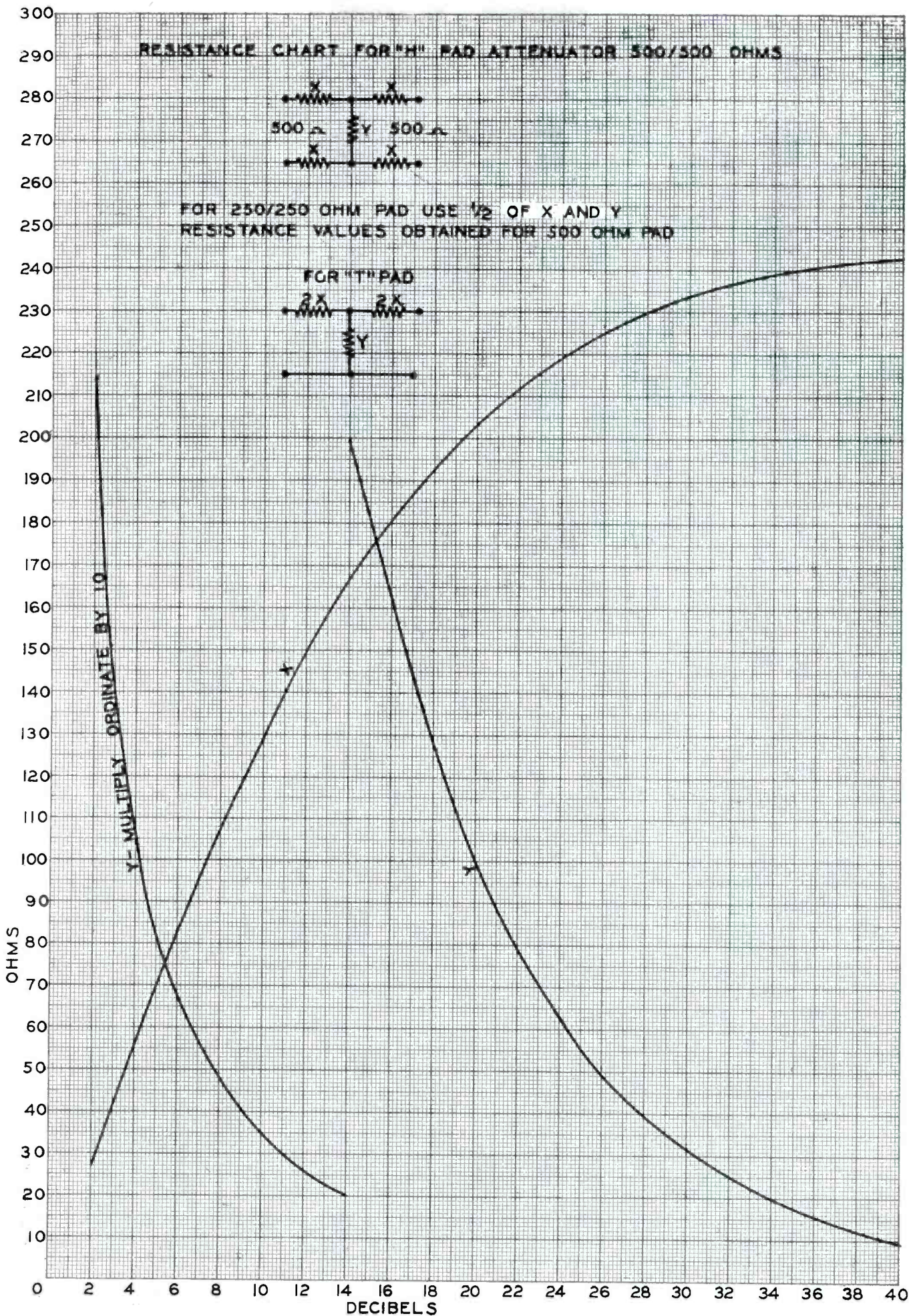
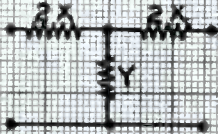

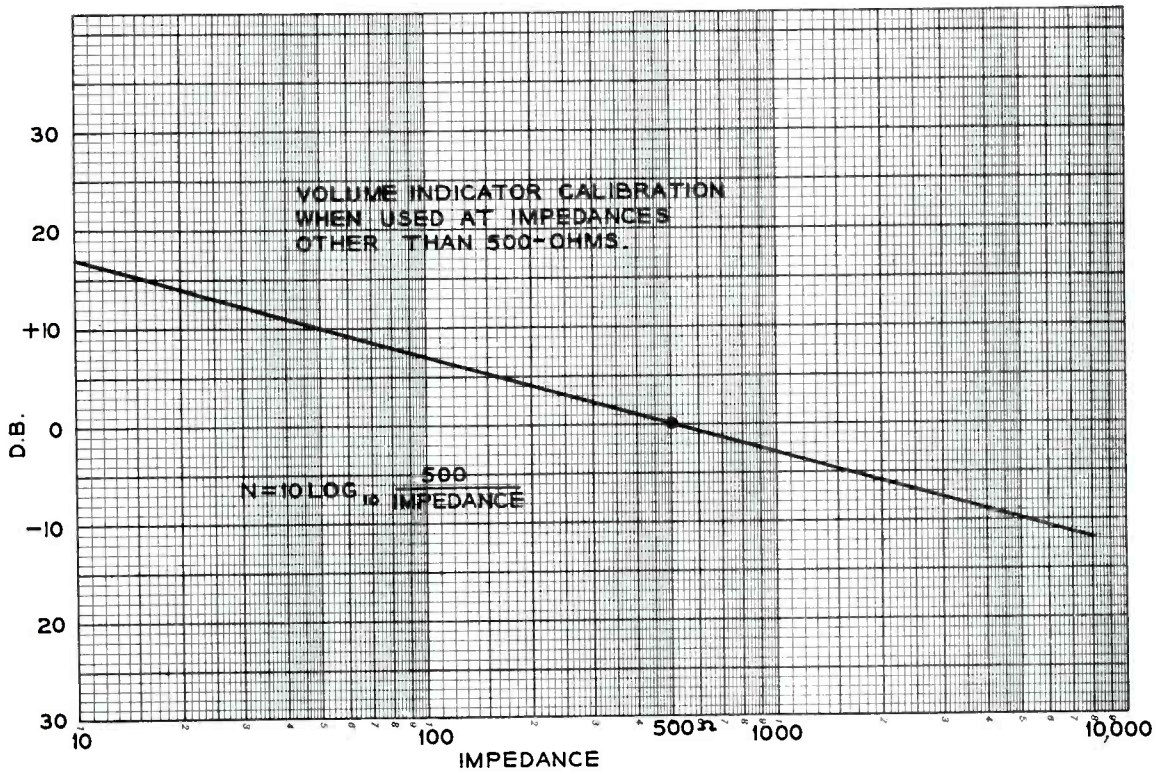

V. I CALIBRATION AT VARIOUS IMPEDANCES

BRIDGING LOSS

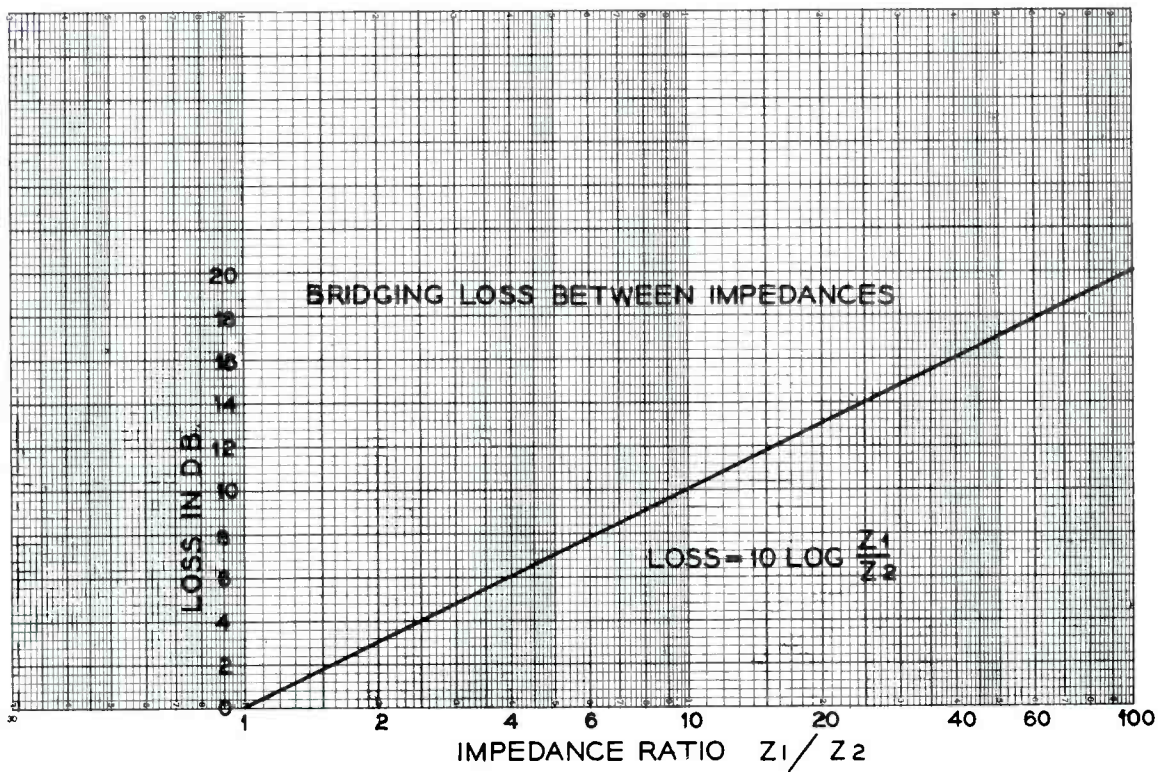

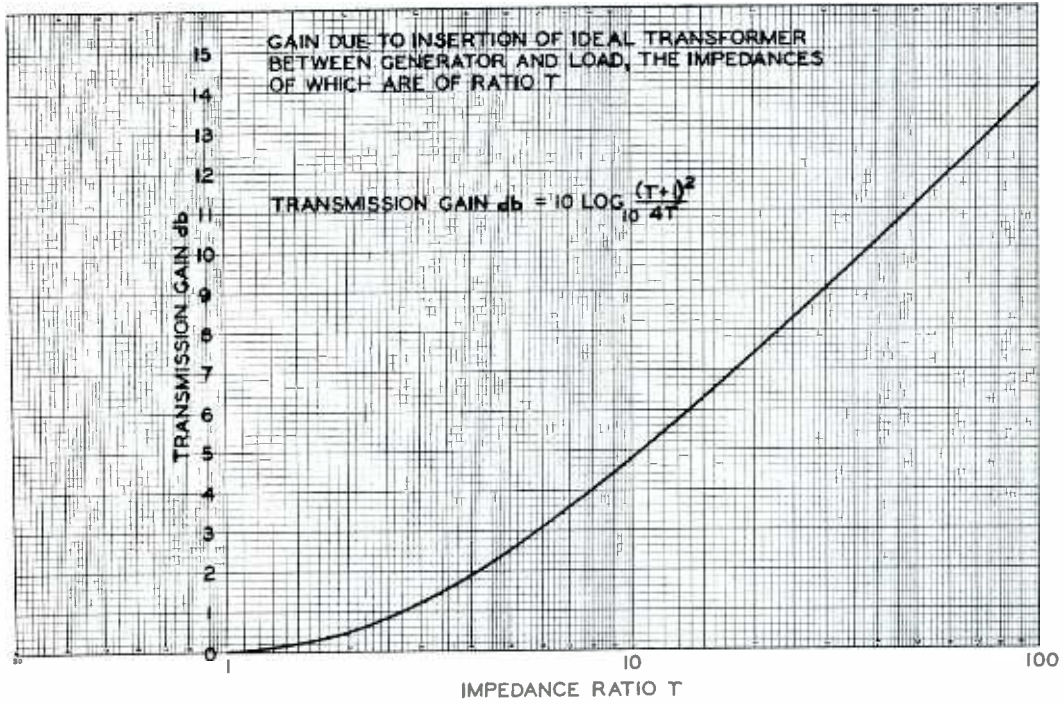

### CONTOURS OF EQUAL LOUDNESS TO THE EAR

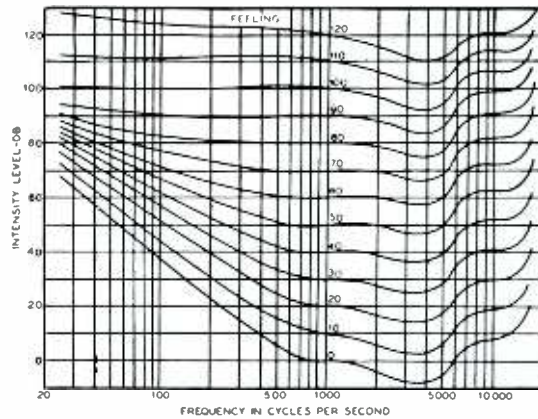

Loudness level contours.

Courtesy of the Acoustical Society of America

# ABSORPTION COEFFICIENTS OF VARIOUS BUILDING MATERIALS

| MATERIAL                                                                                                                      | Absorption coefficients for frequency |      |      |      |      |      |      | Auth. | Date |
|-------------------------------------------------------------------------------------------------------------------------------|---------------------------------------|------|------|------|------|------|------|-------|------|
|                                                                                                                               | 64                                    | 128  | 256  | 512  | 1024 | 2048 | 4096 |       |      |
| Open window, theoretical.....                                                                                                 | 1.0                                   | 1.0  | 1.0  | 1.0  | 1.0  | 1.0  | 1.0  |       |      |
| <b>MASONRY, PLASTERS AND TILES</b>                                                                                            |                                       |      |      |      |      |      |      |       |      |
| Brick Wall, 18", unpainted.....                                                                                               | .021                                  | .024 | .025 | .081 | .042 | .049 | .070 | WS    | 06   |
| " " , 18", painted.....                                                                                                       | .011                                  | .012 | .013 | .017 | .020 | .023 | .025 | WS    | 06   |
| Concrete, porous breeze, 2" blocks, set in 1:3 cement-sand mortar.....                                                        | .15                                   | .21  | .43  | .37  | .39  | .51  |      | BR    | 26   |
| Acoustico, 3/4".....                                                                                                          | .17                                   | .23  | .28  | .36  | .64  |      |      | BS    | 30   |
| Plaster, akoustolith, 1/2", on 1/4" thick lime water.....                                                                     | .21                                   | .24  | .29  | .33  | .37  | .42  |      | CS    | 23   |
| " , ambler, sound absorbing.....                                                                                              | .03                                   | .06  | .14  | .17  | .19  | .11  |      | FW    | 26   |
| " , calacoustic, 1/2".....                                                                                                    | .12                                   | .13  | .16  | .21  | .35  |      |      | VK    | 27   |
| " , gypsum, on hollow tile.....                                                                                               | .012                                  | .013 | .015 | .020 | .028 | .040 | .050 | WS    | 14   |
| " , lime, on wood lath.....                                                                                                   | .048                                  | .020 | .024 | .034 | .030 | .028 | .043 | WS    | 14   |
| " , " , " " with finishing coat.....                                                                                          | .036                                  | .012 | .013 | .018 | .045 | .028 | .055 | WS    | 14   |
| " , sabinite, 1/2", acoustical plaster.....                                                                                   |                                       |      | .166 | .214 | .29  | .34  |      | PS    | 27   |
| " , sabine, 3/8", fixed as tiles.....                                                                                         | .07                                   | .07  | .23  | .43  | .27  | .41  |      | BR    | 26   |
| " , " , 1", (as modified by BRS), trowel applied.....                                                                         | .11                                   | .11  | .29  | .47  | .29  | .38  |      | BR    | 26   |
| Tile, akoustolith, 1".....                                                                                                    | .06                                   | .12  | .36  | .52  | .52  | .36  |      | WS    | 14?  |
| " , Rumford, 1".....                                                                                                          | .09                                   | .18  | .29  | .34  | .34  | .30  |      | WS    | 14?  |
| " , Sabine, acoustical.....                                                                                                   | .064                                  | .068 | .12  | .19  | .25  | .22  |      | WS    | 14   |
| " , " , West Point, (ceramic tile).....                                                                                       | .012                                  | .013 | .018 | .029 | .040 | .048 | .053 | WS    | 14   |
| Acousti-celotex, mineral fibre tile 1 1/4".....                                                                               | .22                                   | .32  | .81  | .80  | .87  | .87  |      | BS    | 31   |
| <b>BUILDING BOARDS AND PANELS</b>                                                                                             |                                       |      |      |      |      |      |      |       |      |
| Armstrong corkboard, 1", 0.875 lbs. per sq. ft.....                                                                           |                                       |      | .08  | .30  | .31  | .28  |      | FW    | 27   |
| " " " 1", sprayed with cold water paint.....                                                                                  |                                       |      | .07  | .30  | .28  | .29  |      | FW    | 27   |
| " " " 2", 1.6 lbs. per sq. ft.....                                                                                            |                                       |      | .17  | .35  | .27  | .34  |      | FW    | 27   |
| Acoustic zenitherm, 1.14", cork granules cemented into a porous stiff tile.....                                               | .03                                   | .13  | .33  | .42  | .42  | .15  |      | FW    | 26   |
| Absorbege 1 1/4".....                                                                                                         | .38                                   | .40  | .45  | .53  | .66  | .91  |      | BS    | 31   |
| Acousti-celotex, type A, 1 3/16", 1.11 lbs. per sq. ft., perforated with 441 small holes per sq. ft. on back of material..... | .13                                   | .28  | .25  | .23  | .23  | .23  |      | CEL   | 29   |
| Acousti-celotex, type B, as above, with perforations exposed on front, painted or unpainted.....                              | .22                                   | .28  | .47  | .53  | .62  | .62  |      | CEL   | 29   |
| Acousti-celotex, type BB, 1 1/4", 1.67 lbs. per sq. ft., perforated on front as above, painted or unpainted.....              | .28                                   | .42  | .70  | .74  | .77  | .77  |      | CEL   | 29   |
| Acousti-celotex, type C, 3/8", 0.48 lbs. per sq. ft., completely perforated, painted or unpainted.....                        | .14                                   | .16  | .30  | .45  | .57  | .55  |      | CEL   | 29   |
| Celotex, 1/2", Standard building board.....                                                                                   | .17                                   | .18  | .20  | .20  | .19  | .19  |      | CEL   | 29   |
| Cork (coarse), 1", slab 3 1/4" x 1 7/8", 1" from wall, framed in wood.....                                                    | .14                                   | .25  | .40  | .25  | .34  | .21  |      | BR    | 26   |
| Fir-tex 1/2", on 2" x 4" wood studs 16" o.c.....                                                                              | .22                                   | .21  | .28  | .31  | .44  | .55  |      | VK    | 31   |
| Insulite, 1/2", Standard building board.....                                                                                  | .23                                   | .26  | .28  | .29  | .32  |      |      | VK    | 28?  |
| " , acoustile, single layer.....                                                                                              | .24                                   | .26  | .30  | .36  | .38  |      |      | VK    | 27?  |
| " " , double layer, 3/4" air space, 3/4" x 1 3/4" strips, 24" o.c.....                                                        | .30                                   | .31  | .34  | .37  | .40  |      |      | VK    | 27?  |
| Masonite, 7/16", building board, bare.....                                                                                    | .19                                   | .25  | .32  | .36  | .36  |      |      | VK    | 28   |
| " , 7/16", on 2" x 1" furring.....                                                                                            | .17                                   | .24  | .28  | .295 | .30  | .28  |      | PS    | 27   |
| " , 7/16", on 2" x 4" studding.....                                                                                           | .18                                   | .245 | .31  | .34  | .30  | .24  |      | PS    | 27   |
| Wood, sheathing, 0.8", pine.....                                                                                              | .064                                  | .098 | .11  | .10  | .081 | .082 | .11  | WS    | 06   |
| " , 3 ply teak panels, 3' x 2'2", 1" from wall, framed in wood.....                                                           | .09                                   | .17  | .17  | .15  | .15  | .15  |      | BR    | 26   |
| <b>FELTS AND MEMBRANES</b>                                                                                                    |                                       |      |      |      |      |      |      |       |      |
| Asbestos felt, 3/8", 33% of volume is solid material.....                                                                     | .06                                   | .06  | .14  | .32  | .25  | .19  | .18  | WS    | 12   |
| " " , 3/8" felted to asbestos cloth.....                                                                                      | .07                                   | .08  | .17  | .35  | .30  | .23  | .20  | WS    | 12   |
| Balsam wool, 1/2", paper and cloth covering, weight 0.20 lbs. per sq. ft.....                                                 | .05                                   | .22  | .41  | .58  | .52  | .39  |      | PS    | 24   |
| " " , 1", paper and cloth covering, 0.265 lbs. per sq. ft.....                                                                | .06                                   | .30  | .56  | .70  | .58  | .46  |      | PS    | 24   |
| " " , 1", paper on under side, other side bare, 0.235 lbs. per sq. ft.....                                                    | .09                                   | .24  | .45  | .64  | .55  | .42  |      | PS    | 24   |
| " " , 1", loosely felted quilt of wood fibre, 0.26 lbs. per sq. ft.....                                                       |                                       | .18  | .44  | .62  | .62  |      |      | FW    | 27   |
| " " , 1", covered with steel tile perforated with 64 1/16" holes per sq. in., .093 lbs. per sq. ft.....                       |                                       | .19  | .47  | .64  | .66  |      |      | FW    | 27   |
| Cabot Quilt, 3 ply, 2 layers 1 1/2" from wall plus canvas cover 1" distant.....                                               | .22                                   | .42  | .74  | .77  | .69  | .44  |      | PB    | 26   |
| Flax-li-num, 9/16".....                                                                                                       | .08                                   | .14  | .31  | .54  | .51  | .45  |      | PS    | 27   |
| " , 1" felted flax fibres, 1.17 lbs. per sq. ft., bare.....                                                                   |                                       | .49  | .61  | .67  | .66  |      |      | FW    | 27   |
| " , 1", with unpainted decorative membrane (0.1 lbs. per sq. ft. mesh 10 per in.) mounted 3/4" distant.....                   |                                       |      | .30  | .61  | .60  | .55  |      | FW    | 27   |
| Hair and asbestos felt, 19% volume solid.....                                                                                 | .04                                   | .05  | .11  | .38  | .55  | .46  | .39  | WS    | 12   |
| Hair felt, 12% volume is solid.....                                                                                           | .09                                   | .10  | .20  | .52  | .71  | .66  | .44  | WS    | 12   |



ABSORPTION COEFFICIENTS OF VARIOUS BUILDING MATERIALS—(Continued)

| MATERIAL                                                                                                                                                   | Absorption coefficients for frequency |       |      |     |      |       |       | Auth. | Date |
|------------------------------------------------------------------------------------------------------------------------------------------------------------|---------------------------------------|-------|------|-----|------|-------|-------|-------|------|
|                                                                                                                                                            | 64                                    | 128   | 256  | 512 | 1024 | 2048  | 4096  |       |      |
| Hair felt, same covered with burlap attached with silicate of soda.....                                                                                    | .13                                   | .13   | .33  | .74 | .76  | .49   | .18   | WS    | 12   |
| " " , same with light membrane (0.87 oz. per sq. ft.) stretched near surface..                                                                             | .17                                   | .20   | .40  | .65 | .27  | .14   | .11   | WS    | 12   |
| " " , same with heavy membrane (2.58 oz. per sq. ft.) stretched near surface..                                                                             | .25                                   | .29   | .41  | .32 | .19  | .11   | .08   | WS    | 12   |
| " " , 1" , in contact with wall.....                                                                                                                       | .09                                   | .10   | .23  | .58 | .72  | .66   | .46   | WS    | 12   |
| " " , 1" , spaced 2" from wall.....                                                                                                                        | .10                                   | .11   | .26  | .62 | .73  | .66   | .45   | WS    | 12   |
| " " , 1" , " 4" " ".....                                                                                                                                   | .11                                   | .13   | .30  | .66 | .74  | .66   | .45   | WS    | 12   |
| " " , 1" , " 6" " ".....                                                                                                                                   | .12                                   | .15   | .35  | .68 | .75  | .66   | .45   | WS    | 12   |
| " " , 1" , located at center of room with barrel ceiling.....                                                                                              | .14                                   | .15   | .32  | .96 | 1.27 | 1.02  | .62   | WS    | 12   |
| " " , 1" , located at sides of room with barrel ceiling.....                                                                                               | .11                                   | .20   | .25  | .54 | .43  | .48   | .20   | WS    | 12   |
| Jute felt, 1/2".....                                                                                                                                       | .038                                  | .049  | .076 | .17 | .48  | .52   | .51   | WS    | 06   |
| " " , 1".....                                                                                                                                              | .12                                   | .15   | .22  | .54 | .63  | .57   | .52   | WS    | 06   |
| " " , 1 1/2".....                                                                                                                                          | .19                                   | .24   | .38  | .63 | .65  | .57   | .52   | WS    | 06   |
| " " , 2".....                                                                                                                                              | .27                                   | .34   | .50  | .69 | .67  | .58   | .52   | WS    | 06   |
| " " , 2 1/2".....                                                                                                                                          | .34                                   | .43   | .59  | .75 | .67  | .58   | .52   | WS    | 06   |
| " " , 3".....                                                                                                                                              | .40                                   | .50   | .66  | .77 | .68  | .58   | .52   | WS    | 06   |
| J-M asbestos akoustikos felt, 1/2" , bare.....                                                                                                             | .07                                   | .14   | .31  | .51 | .51  | .43   | .43   | PS    | 28   |
| " " " " , 3/4" , bare.....                                                                                                                                 | .08                                   | .23   | .45  | .65 | .56  | .46   | .46   | PS    | 28   |
| " " " " , 1" , bare.....                                                                                                                                   | .11                                   | .31   | .59  | .68 | .58  | .46   | .46   | PS    | 28   |
| " " " " , 1 1/2" bare.....                                                                                                                                 | .13                                   | .41   | .73  | .73 | .58  | .46   | .46   | PS    | 28   |
| " " " " , 2" bare.....                                                                                                                                     | .21                                   | .46   | .79  | .75 | .58  | .46   | .46   | PS    | 28   |
| " " " " , 3" bare.....                                                                                                                                     | .33                                   | .56   | .79  | .77 | .58  | .46   | .46   | PS    | 28   |
| J-M nashkote, type AX, 1/2" , (J-M Asbestos akoustikos felt with batiste mem-<br>brane cemented to felt, surface painted with one coat of #3000 paint..... | .10                                   | .22   | .34  | .41 | .32  | .17   | .17   | PS    | 28   |
| J-M nashkote, type AX, 3/4".....                                                                                                                           | .13                                   | .24   | .38  | .45 | .35  | .17   | .17   | PS    | 28   |
| " " , " " , 1".....                                                                                                                                        | .15                                   | .38   | .43  | .40 | .29  | .18   | .18   | PS    | 28   |
| " " , " " , 1 1/2".....                                                                                                                                    | .22                                   | .38   | .41  | .39 | .29  | .20   | .20   | PS    | 28   |
| " " , " " , 2".....                                                                                                                                        | .34                                   | .38   | .44  | .41 | .30  | .23   | .23   | PS    | 28   |
| " " , " " , 3".....                                                                                                                                        | .40                                   | .47   | .48  | .45 | .31  | .24   | .24   | PS    | 28   |
| Membrane, light, 0.87 oz. per sq. ft.....                                                                                                                  | .01                                   | .01   | .04  | .10 | .07  | .02   | .01   | WS    | 12   |
| " " , heavy, 2.58 oz. per sq. ft.....                                                                                                                      | .05                                   | .06   | .16  | .16 | .10  | .07   | .06   | WS    | 12   |
| " " , canvas, 6" from wall.....                                                                                                                            | .10                                   | .12   | .25  | .33 | .15  | .35   | .35   | BR    | 26   |
| Rock wool, banner, 1".....                                                                                                                                 | .35                                   | .49   | .63  | .80 | .83  | ..... | ..... | VK    | 28   |
| " " , " " , 2".....                                                                                                                                        | .44                                   | .59   | .68  | .82 | .84  | ..... | ..... | VK    | 28   |
| " " , " " , 4" , granulated, packed loosely between 2" x 4" , 16" o.c.....                                                                                 | .43                                   | .52   | .57  | .65 | .64  | ..... | ..... | VK    | 28   |
| " " , " " , 1" , 2 layers separated by 1 3/4" air space.....                                                                                               | .53                                   | .64   | .71  | .87 | .90  | ..... | ..... | VK    | 28   |
| " " , gimco, 1 1/4" , silicate fibres felted between metal lath, 1.44 lbs. per<br>sq. ft.....                                                              | .....                                 | ..... | .46  | .57 | .56  | .72   | ..... | FW    | 27   |
| Silent-ceal.....                                                                                                                                           | .28                                   | .74   | .68  | .67 | .75  | .64   | .64   | BS    | 30   |
| Slagbestos, 1 1/2" , slabs, 3/4" from wall.....                                                                                                            | .32                                   | .38   | .65  | .73 | .30  | .29   | .29   | BR    | 26   |
| " " , 1 1/2" , plus canvas 1" distant.....                                                                                                                 | .42                                   | .49   | .80  | .78 | .47  | .42   | .42   | BR    | 26   |
| FLOOR COVERINGS                                                                                                                                            |                                       |       |      |     |      |       |       |       |      |
| Carpet, 0.4" pile, on concrete.....                                                                                                                        | .09                                   | .08   | .21  | .26 | .27  | .37   | .37   | BR    | 26   |
| " " , 0.4" " , on felt, 1/8" on concrete.....                                                                                                              | .11                                   | .14   | .37  | .43 | .27  | .25   | .25   | BR    | 26   |
| " " , 0.4" pile, on felt, on 3/4" polished cork on concrete.....                                                                                           | .17                                   | .14   | .35  | .42 | .23  | .34   | .34   | BR    | 26   |
| " " , 0.4" pile, on felt, on 3/4" pitch pine blocks on concrete.....                                                                                       | .11                                   | .13   | .38  | .45 | .29  | .29   | .29   | BR    | 26   |
| " " , amritza, 0.43" , on concrete.....                                                                                                                    | .09                                   | .06   | .24  | .28 | .11  | .21   | .21   | BR    | 26   |
| " " , cardinal batala, 0.43" on concrete.....                                                                                                              | .12                                   | .10   | .28  | .42 | .21  | .33   | .33   | BR    | 26   |
| " " , 3/16" , rubber on concrete.....                                                                                                                      | .04                                   | .04   | .08  | .12 | .03  | .10   | .10   | BR    | 26   |
| " " , 3/16" , rubber on polished cork on concrete.....                                                                                                     | .09                                   | .04   | .15  | .11 | .10  | .04   | .04   | BR    | 26   |
| Cork, 3/4" flooring slabs, glued down.....                                                                                                                 | .08                                   | .02   | .08  | .18 | .21  | .22   | .22   | BR    | 26   |
| " " , 3/4" " " , waxed and polished.....                                                                                                                   | .04                                   | .03   | .05  | .11 | .07  | .02   | .02   | BR    | 26   |
| Ozite, 3/4".....                                                                                                                                           | .09                                   | .19   | .28  | .51 | .56  | .47   | .47   | PE    | 29   |
| Wood, 3/4" pine blocks, laid in mastic.....                                                                                                                | .05                                   | .03   | .06  | .09 | .10  | .22   | .22   | BR    | 26   |
| " " , 3/4" Gurjan, laid in mastic.....                                                                                                                     | .03                                   | .04   | .07  | .14 | .09  | .15   | .15   | BR    | 26   |
| INDIVIDUAL OBJECTS                                                                                                                                         |                                       |       |      |     |      |       |       |       |      |
| Absorption units in sq. ft.                                                                                                                                |                                       |       |      |     |      |       |       |       |      |
| Audience, per person.....                                                                                                                                  | 1.7                                   | 3.6   | 4.3  | 4.7 | 4.7  | 5.0   | 5.0   | WS    | 06   |
| Cushions, cotton, 2 3/4 sq. ft., under canvas and short nap plush.....                                                                                     | .99                                   | 1.7   | 1.9  | 2.0 | 2.8  | 2.0   | 1.3   | WS    | 06   |
| " " , hair, 2 3/4 sq. ft., under canvas and plush.....                                                                                                     | .86                                   | .99   | 1.1  | 1.8 | 1.7  | 1.4   | .91   | WS    | 06   |
| " " , hair, under canvas and thin leatherette.....                                                                                                         | .67                                   | 1.1   | 1.3  | 1.9 | 1.3  | .73   | .43   | WS    | 06   |
| " " , vegetable fibre, under canvas and damask.....                                                                                                        | .64                                   | .75   | 1.0  | 1.5 | 1.6  | 1.4   | 1.2   | WS    | 06   |
| Chairs, bent ash.....                                                                                                                                      | .15                                   | .15   | .16  | .17 | .18  | .20   | .23   | WS    | 06   |

The abbreviations employed in the above table are: Auth., authority; W.S., W.C. Sabine; P.S., P.E. Sabine; F.W., F.R. Watson; V.K., V.O. Knudsen; B.R., Building Research Station, England; B.S., U.S. Bureau of Standards and CEL, Average of results by P.S., F.W. and V.K.

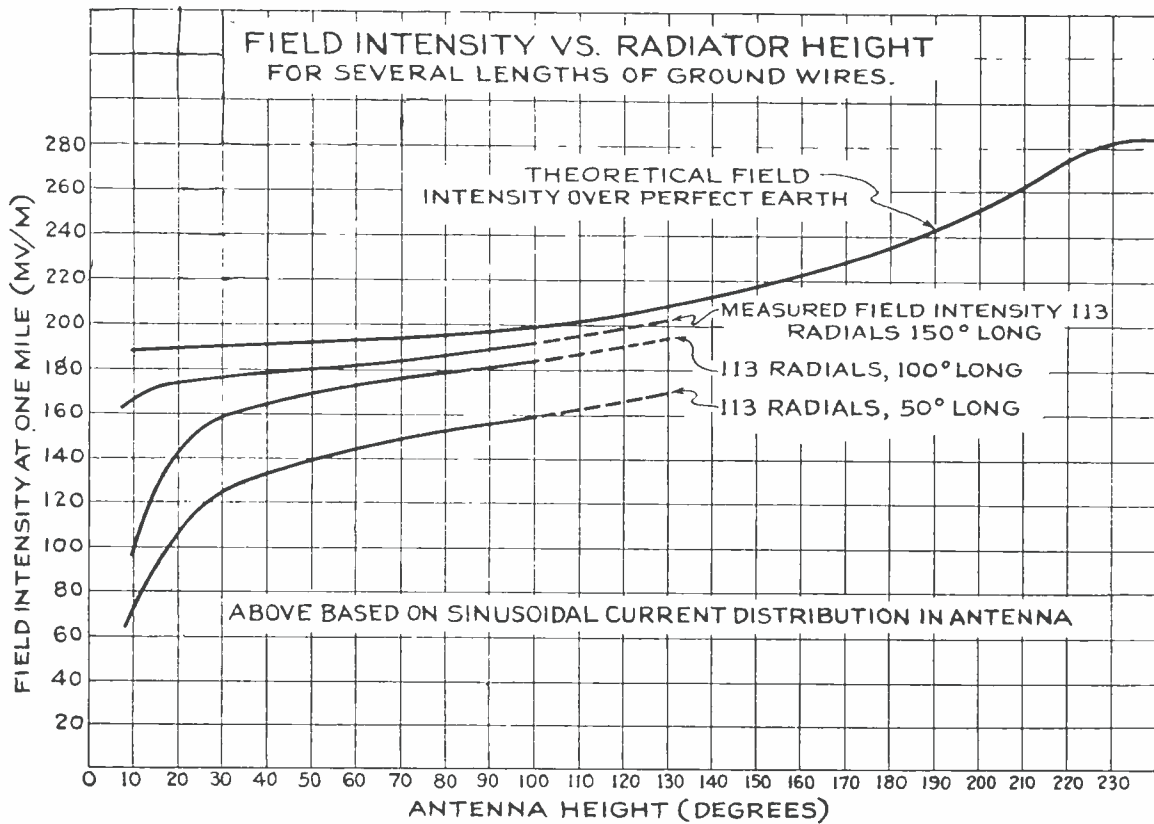

EFFECT OF GROUND WIRES ON FIELD STRENGTH

**RANGE FOR PROPAGATION OVER OPTICAL PATH**  
**HORIZON CALCULATIONS**

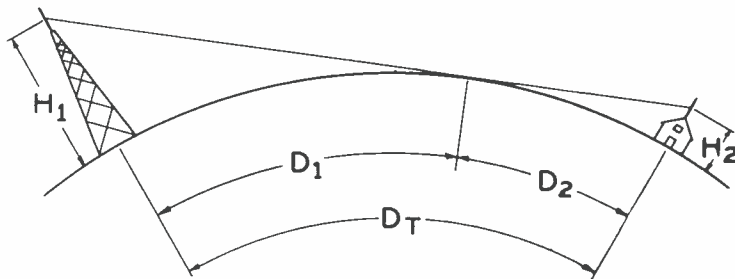

$$D_1 = K\sqrt{H_1}$$

$$D_2 = K\sqrt{H_2}$$

$$D_T = D_1 + D_2 = K [\sqrt{H_1} + \sqrt{H_2}]$$

K = 1.22 WHERE "D" IS IN MILES AND "H" IS IN FEET

K = 3.57 WHERE "D" IS IN KILOMETERS AND "H" IS IN METERS

THE ABOVE FORMULAE NEGLECT REFRACTION AND DIFFRACTION

# APPROXIMATE DISTANCE RANGE OF RADIO RECEPTION.

(BASED ON 10 μV/METER UP TO 2000 KC. DECREASING TO 1 μV/METER AT 20,000 KC., 5 KW. TRANSM.)  
 FROM BUREAU OF STANDARDS CIRCULAR NO. 317.

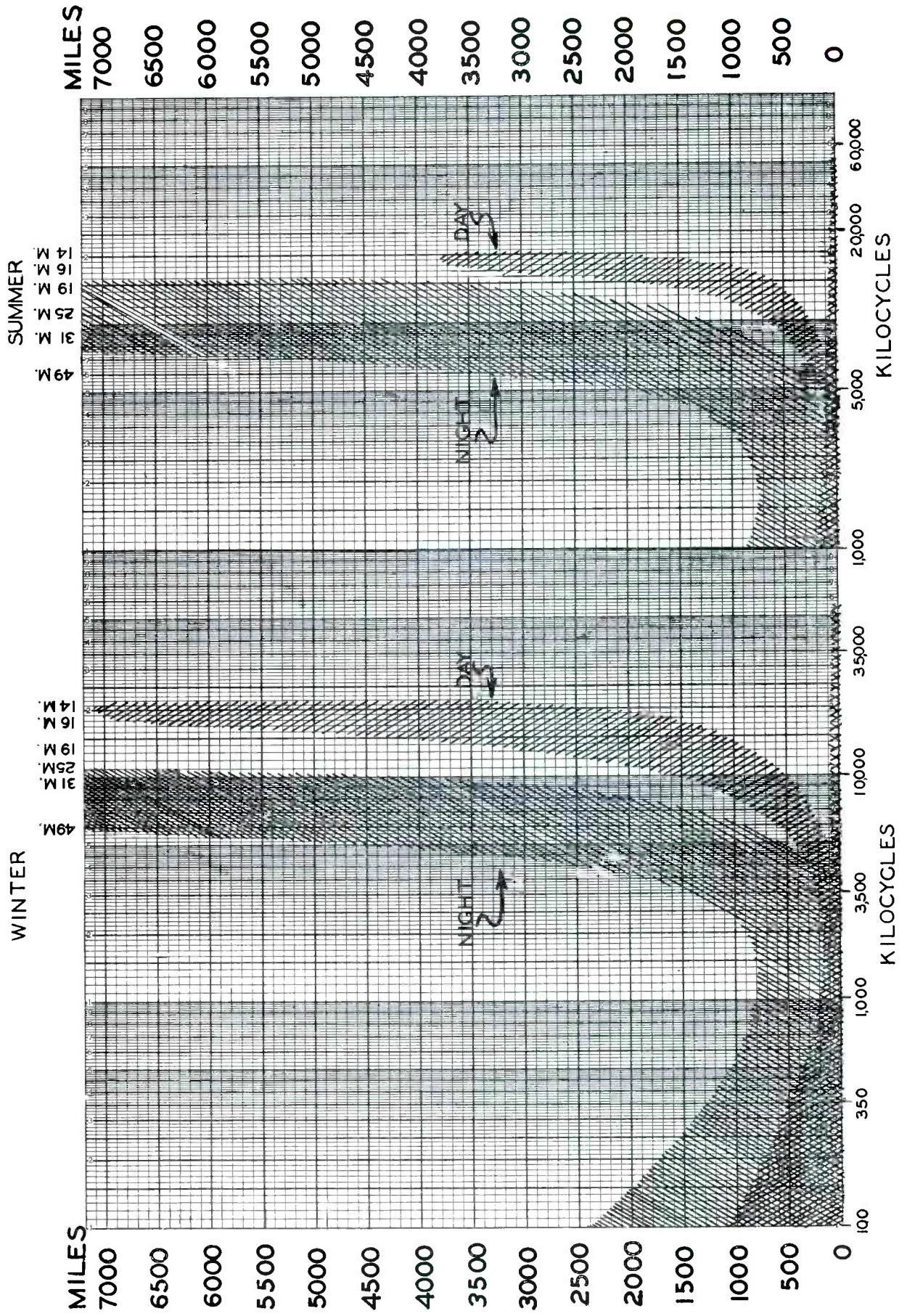

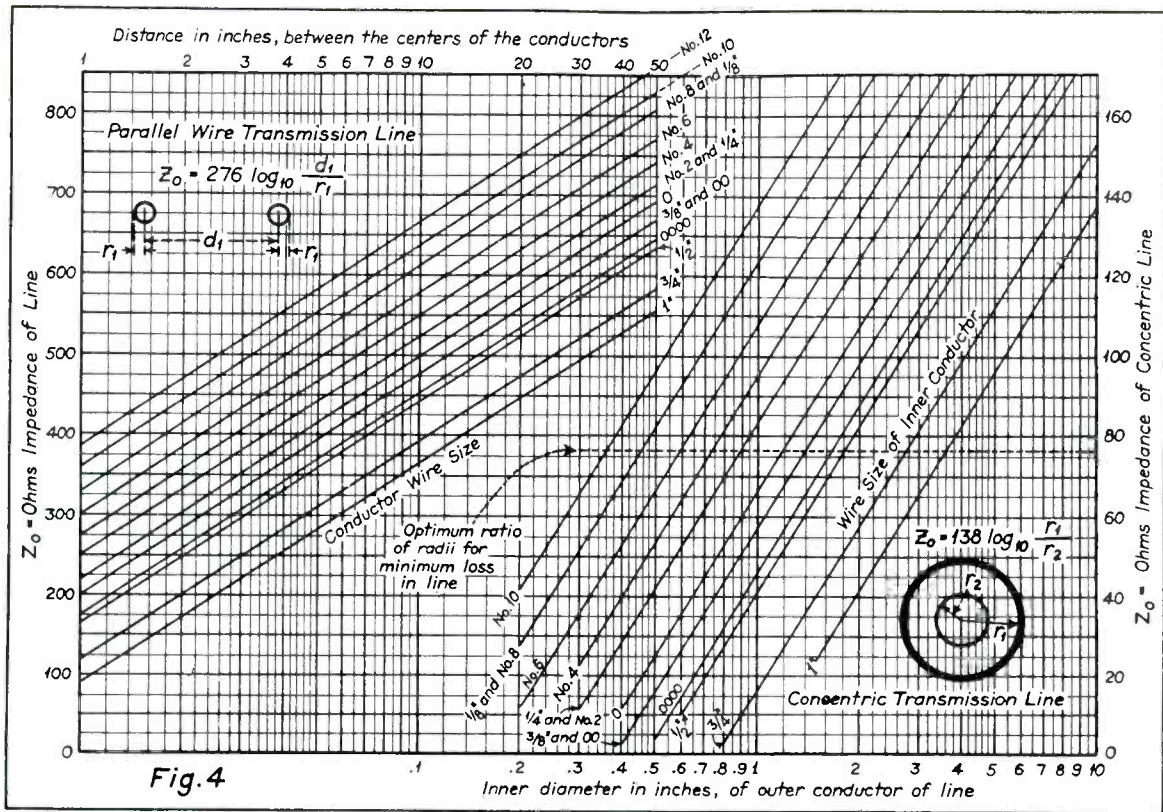

The above curves indicate the characteristic impedance of ungrounded open wire and concentric transmission lines. Curves for the grounded line (below) are for a height 12 feet above the ground. For the larger spacings a change in height of plus or minus four feet will produce a change of impedance of the order of plus or minus five percent. Smaller spacings will be less affected by differences in height. (See also next page.)

### TRANSMISSION LINES

(For two wire lines with one wire grounded)

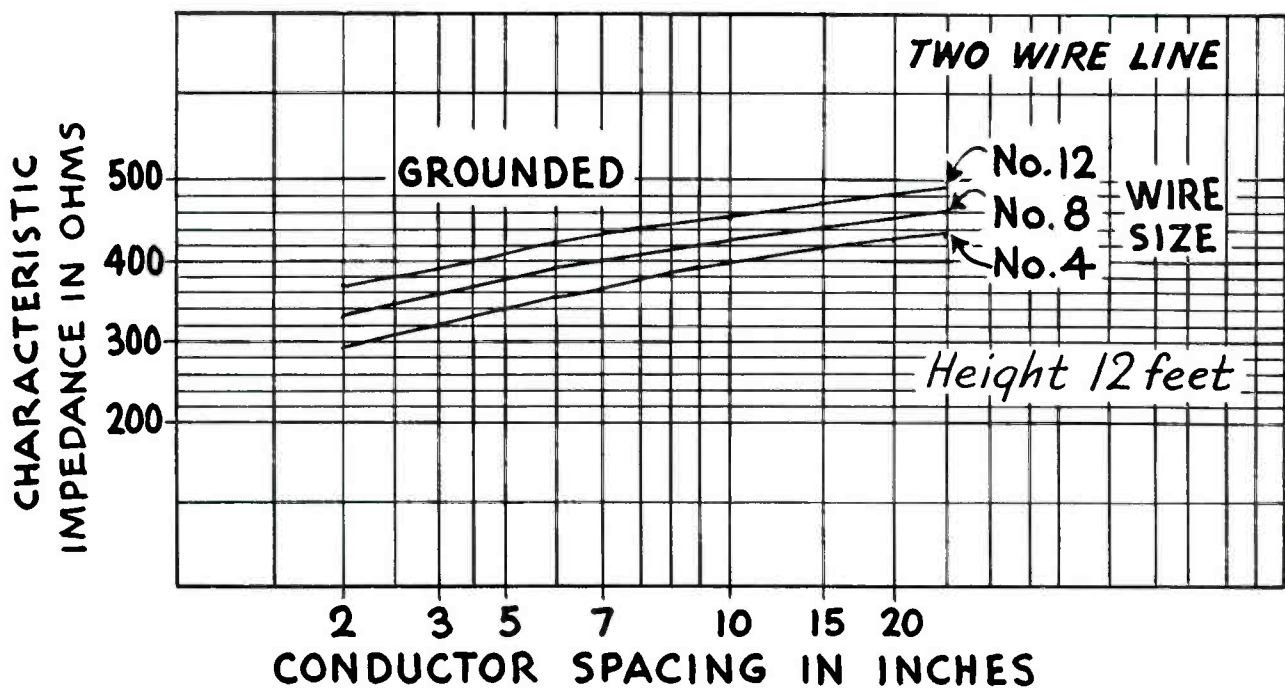

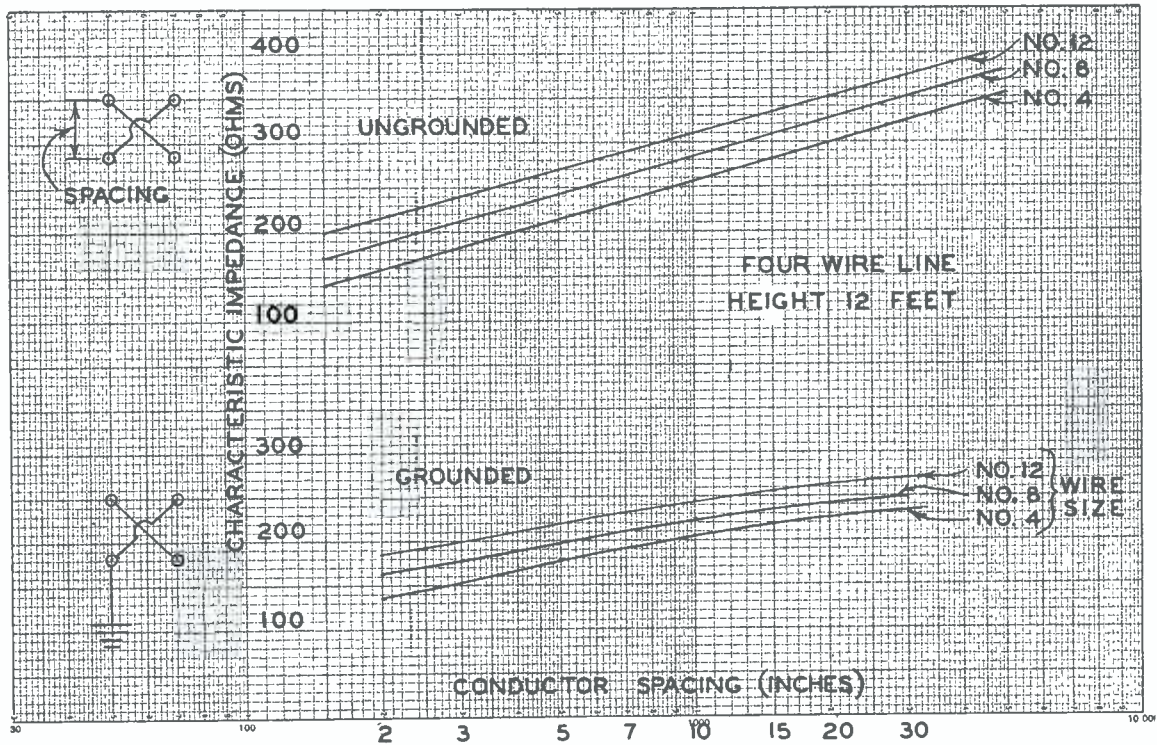

IMPEDANCE OF GROUNDED 4 WIRE TRANSMISSION LINES

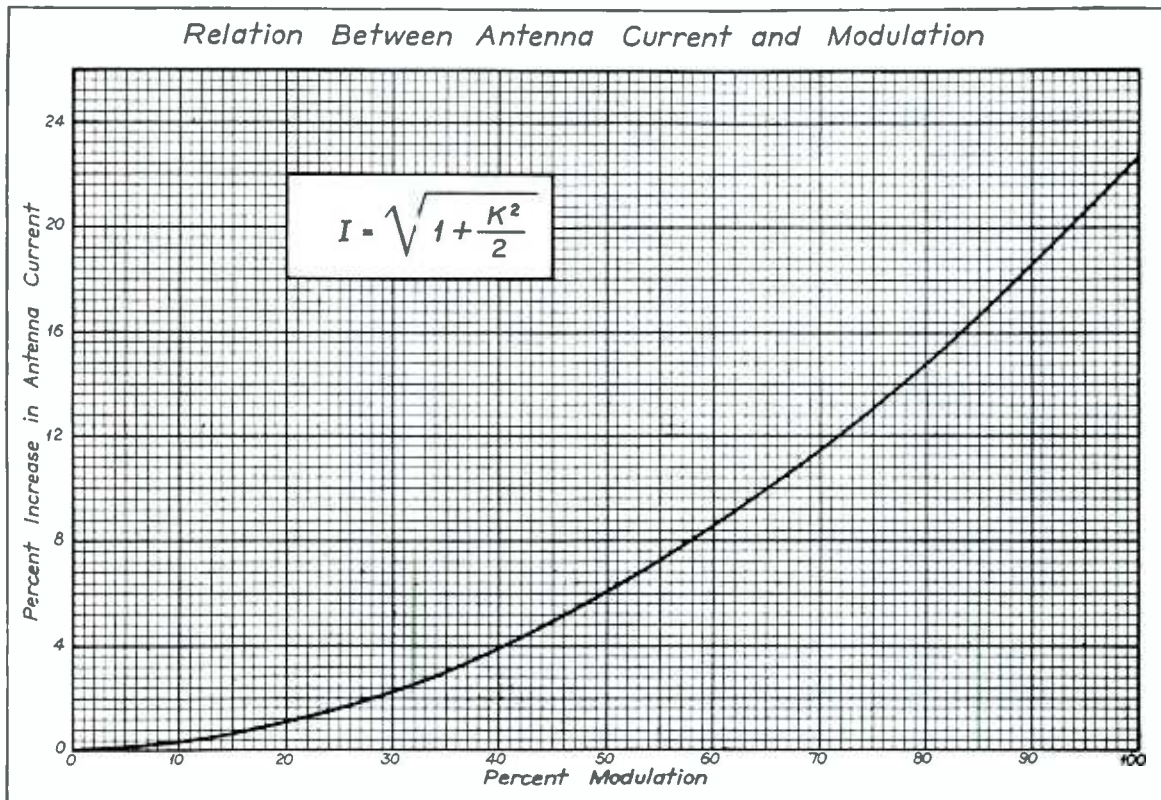

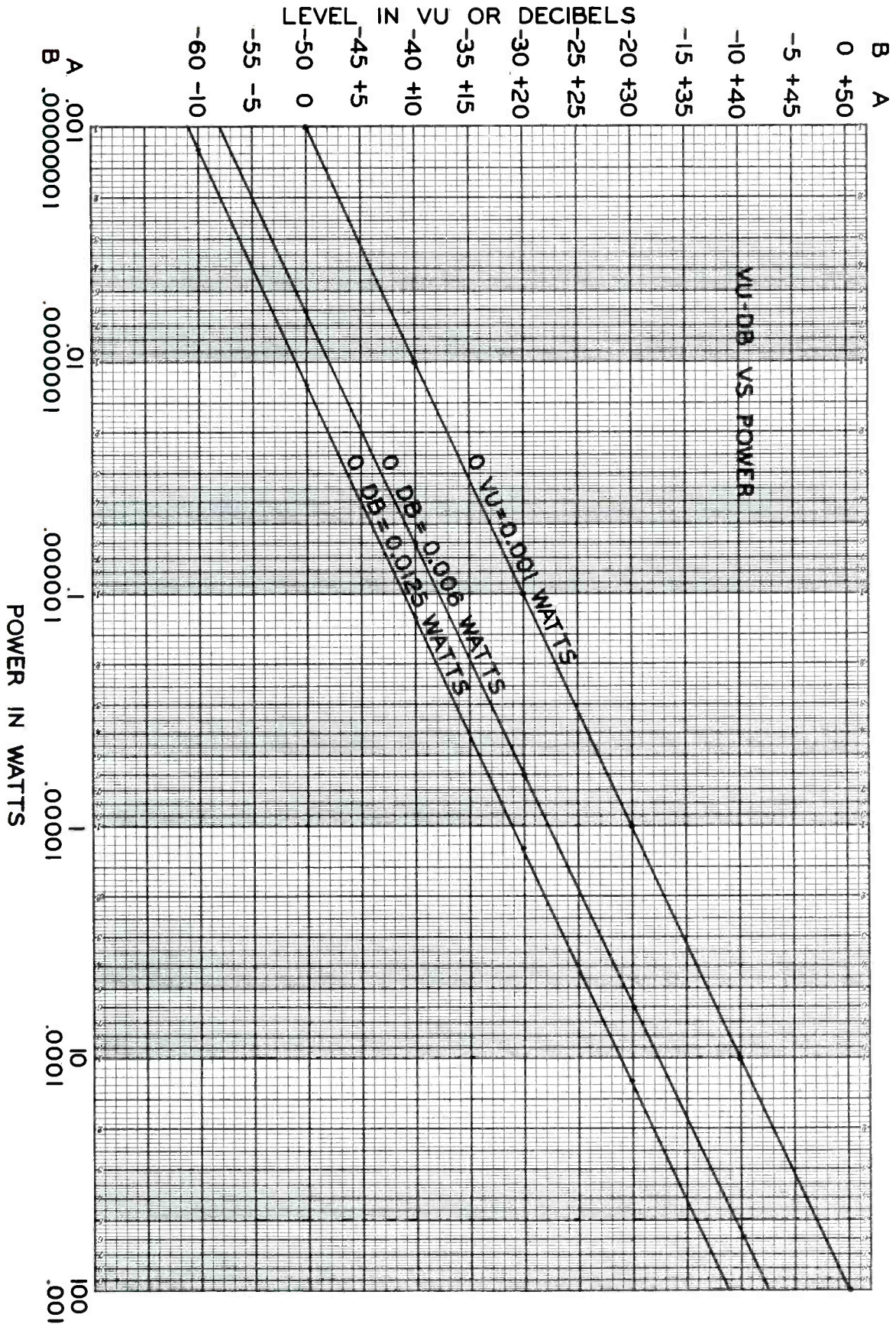



# POWER TUBES AND SPECIAL PURPOSE TUBES

Catalog pages 130-133

## AIR-COOLED TYPES

|          | Net Price |
|----------|-----------|
| RCA-203A | \$10.00   |
| " 204A   | 85.00     |
| " 211    | 10.00     |
| " 800    | 10.00     |
| " 801-A  | 3.45      |
| " 802    | 3.50      |
| " 803    | 28.50     |
| " 804    | 15.00     |
| " 805    | 13.50     |
| " 806    | 22.00     |
| " 807    | 3.50      |
| " 808    | 7.75      |
| " 809    | 2.50      |
| " 810    | 13.50     |
| " 811    | 3.50      |
| " 812    | 3.50      |
| " 813    | 28.50     |
| " 814    | 17.50     |
| " 828    | 17.50     |
| " 829    | 28.75     |
| " 830-B  | 10.00     |
| " 832    | 28.75     |
| " 833    | 85.00     |
| " 834    | 12.50     |
| " 837    | 7.50      |
| " 838    | 11.00     |
| " 841    | 3.25      |
| " 842    | 3.25      |
| " 843    | 12.50     |
| " 844    | 18.00     |
| " 845    | 10.00     |
| " 849    | 120.00    |
| " 850    | 37.50     |
| " 851    | 350.00    |
| " 852    | 16.40     |
| " 860    | 32.50     |
| " 861    | 195.00    |
| " 865    | 12.75     |
| " 891-R* | 410.00    |
| " 892-R* | 410.00    |

\* Credit of \$100.00 allowed for return of radiator and crate in good condition.

## WATER-COOLED TYPES

|         |          |
|---------|----------|
| RCA-207 | \$300.00 |
| " 846   | 300.00   |
| " 858   | 450.00   |
| " 862   | 1650.00  |
| " 887   | 150.00   |
| " 888   | 150.00   |
| " 889   | 275.00   |
| " 891   | 285.00   |
| " 892   | 285.00   |
| " 893   | 750.00   |
| " 898   | 1650.00  |

## RECTIFIERS

|           | Net Price |
|-----------|-----------|
| RCA-217-A | \$20.00   |
| " 217-C   | 20.00     |
| " 836     | 11.50     |
| " 857-B   | 240.00    |
| " 866     | 1.50      |
| " 866-A   | 2.50      |
| " 869-A   | 125.00    |
| " 871     | 7.50      |
| " 872     | 9.00      |
| " 872-A   | 11.00     |
| " 1616    | 5.75      |

## CATHODE-RAY TYPES AND KINESCOPIES

|              |         |
|--------------|---------|
| 3AP1/906-P1  | \$13.50 |
| 3AP4/906-P4  | 13.75   |
| 5AP4/1805-P4 | 22.00   |
| 5BP1/1802-P1 | 24.75   |
| 5BP4/1802-P4 | 22.00   |
| 7AP4         | 29.00   |
| 9AP4/1804-P4 | 50.00   |
| 12AP4/1803P4 | 60.00   |
| RCA-902      | 7.50    |
| " 904        | 52.50   |
| " 905        | 45.00   |
| " 907        | 48.75   |
| " 908        | 18.00   |
| " 909        | 49.00   |
| " 910        | 21.25   |
| " 913        | 4.00    |
| " 914        | 85.00   |
| " 1840       | 650.00  |
| " 1848       | 525.00  |
| " 1849       | 650.00  |
| " 1850       | 650.00  |
| " 1898       | 24.00   |
| " 1899       | 95.00   |

## CATHODE-RAY RECTIFIERS

|         |         |
|---------|---------|
| RCA-878 | \$11.00 |
| " 884   | 2.00    |
| " 885   | 2.00    |

## PHOTOTUBES

|         |        |
|---------|--------|
| RCA-868 | \$3.70 |
| " 917   | 4.75   |
| " 918   | 4.50   |
| " 919   | 4.75   |
| " 920   | 5.25   |
| " 921   | 2.00   |
| " 922   | 2.00   |
| " 923   | 2.60   |
| " 924   | 2.00   |
| " 925   | 2.00   |
| " 926   | 3.00   |
| " 927   | 3.70   |
| " 928   | 2.00   |

## MISCELLANEOUS

|                  | Net Price |
|------------------|-----------|
| VR105/30         | \$1.25    |
| VR150/30         | 1.25      |
| RCA-840          | 6.00      |
| " 864            | 1.00      |
| " 874            | 1.50      |
| " 954 Acorn Type | 5.00      |
| " 955 Acorn Type | 3.00      |
| " 956 Acorn Type | 5.00      |
| " 957 Acorn Type | 3.00      |
| " 958 Acorn Type | 3.00      |
| " 959 Acorn Type | 5.00      |
| " 991            | .90       |
| " 1602           | 2.75      |
| " 1603           | 4.75      |
| " 1608           | 4.00      |
| " 1609           | 1.60      |
| " 1610           | 2.00      |
| " 1612           | 3.25      |
| " 1613           | 2.75      |
| " 1614           | 3.50      |
| " 1619           | 4.75      |
| " 1620           | 2.50      |
| " 1621           | 2.50      |
| " 1622           | 2.75      |
| " 1623           | 2.50      |
| " 1624           | 4.75      |
| " 1628           | 40.00     |
| " 1851           | 2.10      |
| " 2050           | 4.50      |
| " 2051           | 2.50      |

## SOCKETS, MOUNTINGS, JACKETS

|                    |        |
|--------------------|--------|
| UT-102-A           | \$2.25 |
| UT-103             | 12.50  |
| UT-541-A           | 1.75   |
| UT-542-A           | 1.50   |
| UT-1085, -6        | 4.65   |
| UT-1285-A(MI-7415) | 35.00  |
| UT-1289            | 310.00 |
| UT-4289            | 21.50  |

## GASKETS

|         |        |
|---------|--------|
| PX-1178 | \$ .17 |
| PX-1181 | .98    |
| PX-1281 | .80    |

## MISCELLANEOUS

|              |          |
|--------------|----------|
| MI-7422-A    | 2.95     |
| MI-7432      | 2.30     |
| Stock 16402} | Price on |
| Stock 16679} | request  |

# RCA MANUFACTURING CO., Inc., Camden, N. J., U. S. A.

## TRANSMITTER SALES OFFICES AT:

1270 SIXTH AVENUE  
NEW YORK CITY

589 E. ILLINOIS STREET  
CHICAGO, ILL.

530 CITIZENS & SOUTHERN BANK BLDG.  
ATLANTA, GA.

SANTA FE BUILDING  
DALLAS, TEXAS

1016 N. SYCAMORE STREET  
HOLLYWOOD, CALIF.

170 NINTH STREET  
SAN FRANCISCO, CALIF.

| Type Number | Master Item No. | AF & RF MEASURING EQUIPMENT (Continued)                                                                                                    | Net Price       | Catalog Page |
|-------------|-----------------|--------------------------------------------------------------------------------------------------------------------------------------------|-----------------|--------------|
| 302-A       | 7546            | Wide Radio Logarithmic Audio Meter including 1 set of tubes<br>One set of tubes.....                                                       | 150.00<br>3.55  | 92           |
| 306-A       | 8210            | †Audio Frequency Meter. Rack mounting (Umber Gray), including 1 set tubes.....                                                             | 240.00          | 106          |
| 306-A       | 8210-B          | Rack Mounting (Black).....                                                                                                                 | 240.00          | 106          |
| 306-A       | 8210-A          | Cabinet Mounting (Umber Gray).....<br>One set of tubes.....                                                                                | 250.00<br>7.25  | 106          |
| 311-A       | MI-8211         | Broadcast Frequency Monitor. Rack Mounting (Black Finish) including 1 set of tubes.....                                                    | 560.00          |              |
| 311-A       | MI-8211-A       | Broadcast Frequency Monitor. Rack Mounting, including 1 set of tubes (Umber Gray or Transmitter Gray Finish).....<br>One set of tubes..... | 570.00<br>11.75 |              |
| 312-A       | MI-8219         | RF Noise Meter, including 1 set of tubes.....                                                                                              | 200.00          |              |

### TELEVISION MEASURING EQUIPMENT

|       |      |                                                                     |               |     |
|-------|------|---------------------------------------------------------------------|---------------|-----|
| 350-A | 7538 | Square Wave Generator, complete with tubes.....                     | 400.00        | 102 |
| 351-A | 7543 | Video Sweep Oscillator, including tubes.....                        | 400.00        | 102 |
| 352-A | 8207 | RF and IF Sweep Oscillator, including tubes and crystal.....        | 490.00        | 103 |
| 353-A | 8205 | Sweep Rectifier (less tube).....<br>One set of tubes for 353-A..... | 20.00<br>3.00 | 103 |
| 560-A |      | Synchronizing Generator, including 560-A and 561-A less tubes       | 3600.00       | 103 |

### INDUSTRIAL MEASURING EQUIPMENT

|        |            |                                                  |        |     |
|--------|------------|--------------------------------------------------|--------|-----|
| 307-A1 | 7506-A1    | Pressure Conversion Unit.....                    | 120.00 | 104 |
| 307-A2 | 7506-A2    | Pressure Conversion Unit.....                    | 120.00 | 104 |
|        | Stock 9784 | MI-7534 Amplifier, including 1 set of tubes..... | 250.00 | 105 |
|        | Stock 9786 | MI-7536 Synchronizer.....                        | 130.00 | 105 |
|        | Stock 9796 | MI-7537 Voltage Regulating Transformer.....      | 40.00  | 105 |
|        | Stock 9765 | MI-7533-3 Vibration Pickup.....                  | 25.00  | 106 |
|        | 9787       | MI-8214 Vibration Pickup Calibrator.....         | 30.00  | 106 |

† For Black or Transmitter Gray, add \$3.00.

## *Faradon* Condensers

Listing of net prices to broadcasting stations by UC numbers. See full listing in catalog, Pages 123-126.

| UC Model | Net Price | UC Model | Net Price | UC Model | Net Price | UC Model | Net Price | UC Model | Net Price | UC Model | Net Price |
|----------|-----------|----------|-----------|----------|-----------|----------|-----------|----------|-----------|----------|-----------|
| 2325A    | \$26.40   | 3000     | \$40.80   | 3042     | \$40.80   | 3086     | \$4.40    | 3120     | \$4.40    | 3244     | \$168.00  |
| 2344     | 26.40     | 3004     | 4.80      | 3043     | 96.00     | 3087     | 4.80      | 3121     | 4.80      | 3245     | 308.80    |
| 2355A    | 26.40     | 3005     | 14.40     | 3045     | 4.40      | 3088     | 14.40     | 3122     | 14.40     | 3246     | 308.80    |
| 2360A    | 26.40     | 3006     | 15.20     | 3046     | 4.80      | 3089     | 15.20     | 3123     | 15.20     | 3247     | 308.80    |
| 2366     | 26.40     | 3008A    | 40.80     | 3047     | 14.40     | 3091     | 40.80     | 3124     | 26.40     | 3248     | 308.80    |
| 2373A    | 26.40     | 3009A    | 96.00     | 3048     | 15.20     | 3092     | 96.00     | 3125     | 40.80     | 3249     | 216.00    |
| 2374A    | 26.40     | 3011     | 4.40      | 3050     | 40.80     | 3094     | 4.40      | 3126A    | 4.40      | 3250     | 216.00    |
| 2446     | 26.40     | 3012     | 4.80      | 3053     | 4.40      | 3095B    | 4.80      | 3127A    | 4.80      | 3251     | 216.00    |
| 2455     | 26.40     | 3013     | 14.40     | 3054     | 4.80      | 3096     | 14.40     | 3128     | 14.40     | 3252     | 216.00    |
| 2478     | 26.40     | 3014     | 15.20     | 3055A    | 14.40     | 3097     | 15.20     | 3129A    | 15.20     | 3253     | 216.00    |
| 2507     | 96.00     | 3016     | 26.40     | 3056     | 15.20     | 3099     | 40.80     | 3130A    | 26.40     | 3254     | 216.00    |
| 2551A    | 26.40     | 3017A    | 40.80     | 3061     | 4.40      | 3100     | 96.00     | 3131A    | 40.80     | 3255     | 216.00    |
| 2663A    | 26.40     | 3018A    | 96.00     | 3062A    | 4.80      | 3102A    | 4.40      | 3132     | 4.40      | 3260     | 37.00     |
| 2979     | 40.80     | 3020     | 4.40      | 3063     | 14.40     | 3103     | 4.80      | 3133     | 4.80      | 3272     | 14.00     |
| 2980     | 4.80      | 3021     | 4.80      | 3064     | 15.20     | 3104     | 14.40     | 3192A    | 216.00    | 3278     | 27.00     |
| 2981     | 15.20     | 3022     | 14.40     | 3066     | 26.40     | 3105     | 15.20     | 3198A    | 96.00     | 3279     | 27.00     |
| 2983     | 4.40      | 3023     | 15.20     | 3067     | 40.80     | 3106     | 26.40     | 3202     | 4.40      | 3286     | 27.00     |
| 2984     | 4.80      | 3025     | 26.40     | 3068A    | 96.00     | 3107     | 40.80     | 3204     | 27.00     | 3287     | 37.00     |
| 2985     | 14.40     | 3026A    | 40.80     | 3070     | 4.40      | 3108     | 4.40      | 3222A    | 40.80     | 3288     | 37.00     |
| 2986     | 15.20     | 3027     | 96.00     | 3071     | 4.80      | 3109     | 4.80      | 3233     | 188.00    | 3289     | 37.00     |
| 2988     | 26.40     | 3029     | 4.40      | 3072     | 14.40     | 3110     | 14.40     | 3234     | 188.00    | 3290     | 37.00     |
| 2989     | 4.40      | 3030     | 4.80      | 3073     | 15.20     | 3111     | 15.20     | 3235     | 188.00    | 3291     | 37.00     |
| 2990A    | 4.80      | 3031A    | 14.40     | 3075     | 40.80     | 3112     | 26.40     | 3236     | 188.00    | 3292     | 27.00     |
| 2991     | 14.40     | 3032     | 15.20     | 3076     | 96.00     | 3113A    | 40.80     | 3237     | 188.00    | 3294     | 27.00     |
| 2992     | 15.20     | 3034A    | 40.80     | 3078     | 4.40      | 3114     | 4.40      | 3238     | 188.00    | 3295     | 27.00     |
| 2994     | 40.80     | 3035     | 96.00     | 3079     | 4.80      | 3115     | 4.80      | 3239     | 188.00    | 3299     | 27.00     |
| 2995     | 4.40      | 3037     | 4.40      | 3080     | 14.40     | 3116     | 14.40     | 3240     | 188.00    | 3300     | 27.00     |
| 2996     | 4.80      | 3038     | 4.80      | 3081     | 15.20     | 3117     | 15.20     | 3241     | 188.00    | 3301     | 27.00     |
| 2997     | 14.40     | 3039     | 14.40     | 3083     | 40.80     | 3118     | 26.40     | 3242     | 168.00    | 3302     | 27.00     |
| 2998     | 15.20     | 3040     | 15.20     | 3084     | 96.00     | 3119     | 40.80     | 3243     | 168.00    | 3303     | 27.00     |



| Type Number                            | Master Item No. | CATHODE RAY OSCILLOGRAPHS (Continued)                        | Net Price         | Catalog Page |
|----------------------------------------|-----------------|--------------------------------------------------------------|-------------------|--------------|
|                                        | Stock 9641      | 3" Special Cathode Ray Oscillograph,                         |                   |              |
|                                        | MI-7530         | including 1 set tubes.....                                   | 110.00            | 90           |
|                                        | Stock 155       | 3" Standard Cathode Ray Oscillograph, including 1 set tubes  | 63.95             | 91           |
|                                        | Stock 151-2     | 2" Cathode Ray Oscillograph, including 1 set tubes.....      | 49.95             | 91           |
|                                        | Stock 151       | 1" Cathode Ray Oscillograph, including 1 set tubes.....      | 39.95             | 91           |
| <b>GENERAL PURPOSE METERS</b>          |                 |                                                              | <b>125.00</b>     |              |
| TMV-178                                | Stock 9819      | Ultra Sensitive DC Meter.....                                | <del>185.00</del> | 92           |
|                                        | MI-7521         |                                                              |                   |              |
| 302-A                                  | 7546            | Wide Radio Logarithmic Audio Meter, including 1 set tubes..  | 150.00            | 92           |
| <b>POWER SUPPLIES</b>                  |                 |                                                              |                   |              |
| 310-A                                  | 7524            | Regulated Power Unit, including 1 set tubes.....             | 43.50             | 93           |
| 93-A                                   | 7519            | Vibrator Power Unit, including 1 tube.....                   | 80.00             | 93           |
|                                        | Stock 9785      | Vibrator Power Supply.....                                   | 80.00             | 93           |
| 580-A                                  |                 | Regulated Power Unit (less tubes).....                       | 115.00            | 94           |
| 582-A                                  |                 | Filter Panel .....                                           | 20.00             | 94           |
|                                        | MI-3526         | Regulated Power Supply (less tubes).....                     | 85.00             | 94           |
|                                        | MI-1500-A1      | Filament Supply Unit (less tubes).....                       | 181.50            | 94           |
|                                        | Stock 9796      | Voltage Regulating Transformer.....                          | 40.00             | 94           |
| <b>AF &amp; RF MEASURING EQUIPMENT</b> |                 |                                                              |                   |              |
| 68-B                                   | MI-7511-A       | Beat Frequency Oscillator,                                   |                   |              |
|                                        |                 | including 1 set tubes. Rack Mounting (Black Finish)...       | 225.00            | 95           |
|                                        | MI-7511-B       | Beat Frequency Oscillator,                                   |                   |              |
|                                        |                 | including 1 set tubes. Rack Mounting (Transmitter Gray)      | 228.00            | 95           |
|                                        | MI-7511-C       | Beat Frequency Oscillator,                                   |                   |              |
|                                        |                 | including 1 set tubes. On portable cabinet (Black).....      | 225.00            | 95           |
|                                        | MI-7511-D       | Beat Frequency Oscillator                                    |                   |              |
|                                        |                 | including 1 set of tubes. Rack Mounting (Umber Gray) ..      | 225.00            | 96           |
|                                        |                 | One set of tubes.....                                        | 6.50              |              |
| 69-B                                   | MI-7512-A       | Distortion Meter,                                            |                   |              |
|                                        |                 | including 1 set tubes. Rack Mounting (Black Finish)...       | 200.00            | 96           |
|                                        | MI-7512-B       | Distortion Meter, including 1 set tubes. Rack mounting.      |                   |              |
|                                        |                 | (Transmitter Gray) .....                                     | 203.00            | 96           |
|                                        | MI-7512-C       | Distortion Meter including 1 set tubes. Cabinet Type (Black) | 210.00            |              |
|                                        | MI-7512-D       | Distortion Meter including 1 set of tubes. Rack Mounting     |                   |              |
|                                        |                 | (Umber Gray) .....                                           | 200.00            | 96           |
|                                        | 7514            | Cabinet for MI-7512 (Black).....                             | 15.00             | 96           |
|                                        |                 | One set of tubes.....                                        | 3.30              |              |
| 89-B                                   | 7515-B          | °Attenuator Panel (Black). This is similar to 89-A except    |                   |              |
|                                        |                 | Meter Calibrated with 1 mw zero level.....                   | 145.00            | 97           |
|                                        | 7515-C          | °Same as 7515-B except Transmitter Gray Finish.....          | 145.00            | 97           |
|                                        | 7520            | Cabinet for 89B (Black).....                                 | 12.00             | 97           |
| 13-D                                   | 4161            | *Volume Indicator (less tubes) (Black Finish).....           | 140.00            | 97           |
|                                        |                 | One set of tubes.....                                        | 2.35              |              |
| 303-A                                  | 7531            | †Frequency Limit Monitor. Rack mounting (Umber Gray) in-     |                   |              |
|                                        |                 | cluding 1 set tubes, less Crystal.....                       | 187.50            | 98           |
|                                        |                 | One set of tubes.....                                        | 6.95              |              |
|                                        | 7531-A          | Frequency Limit Monitor. Cabinet mounting, including 1 set   |                   |              |
|                                        |                 | tubes (Umber Gray Finish).....                               | 200.00            | 98           |
|                                        |                 | Crystal for 303A.....                                        | 50.00             | 98           |
| 66-A                                   | 7502            | *Modulation Monitor. Rack mounting. (Black) 1 set tubes...   | 203.00            | 99           |
|                                        |                 | One set of tubes.....                                        | 3.40              |              |
|                                        | 7504            | Cabinet for 66-A (Black).....                                | 12.00             | 99           |
| 300-A                                  | 7540-A          | *Phase Meter, including 1 set tubes (Black).....             | 275.00            | 99           |
| 300-B                                  | MI-8217         | Three Element Array Kit.....                                 | 60.00             |              |
|                                        | MI-8216         | Remote Antenna, Current Indicator Panel.....                 | 190.00            |              |
| 301-A                                  | 8208            | UHF Field Intensity Meter. Complete power supply, tubes      |                   |              |
|                                        |                 | and accessories (see p. 92 reference for 302-A noise meter)  | 950.00            | 100          |
|                                        |                 | One set of tubes.....                                        | 13.15             |              |

\* For Umber Gray or Transmitter Gray Finish, add \$3.00.

° For Umber Gray Finish, add \$3.00.

† For Black or Transmitter Gray, add \$3.00.

| Type Number | Master Item No. |                                                      | Net Price | Catalog Page |
|-------------|-----------------|------------------------------------------------------|-----------|--------------|
|             |                 | <b>TRANSCRIPTION TURNTABLE EQUIPMENT (Continued)</b> |           |              |
|             | 4897            | Driver Insert for 72-B Recorder.....                 | .75       | 56           |
|             | 4861            | Tone Arm Lift Mechanism for 70-B or MI-4857.....     | 3.75      | 56           |
|             | 4879-A          | Steel Recording Styli—package of 6.....              | 1.20      | 56           |
|             | 4878-A          | Sapphire Recording Styli.....                        | 3.60      | 56           |
| Code 803-5  |                 | Recording Disc 10" diameter .036" thick.....         | .53       | 56           |
| 806-5       |                 | Recording Disc 12" diameter .036" thick.....         | .67       | 56           |
| 808-5       |                 | Recording Disc 16" diameter .036" thick.....         | 1.20      | 56           |
| 808-6       |                 | Recording Disc 16" diameter .050" thick.....         | 1.33      | 56           |
|             | 15889           | Record Weight.....                                   | 2.80      | 56           |
|             | 4888            | Cutter Float Stabilizer for 72-B.....                | 14.00     | 57           |
|             | 4887            | High Fidelity Recording Head.....                    | 175.00    | 57           |

**FIELD AMPLIFIER EQUIPMENT**

|       |          |                                                         |        |    |
|-------|----------|---------------------------------------------------------|--------|----|
| OP-5  | 4223-C   | Portable Amplifier (250 ohms).....                      | 295.00 | 58 |
| OP-5X | 4223-G   | Portable Amplifier with vu meter (50 ohms).....         | 325.00 | 58 |
| OP-5X | 4223-E   | Portable Amplifier with vu meter (250 ohms).....        | 325.00 | 58 |
|       | 10651    | One set of tubes for OP-5 (includes 2 meter lamps)..... | 9.40   | 58 |
|       | 10801    | Set of batteries for OP-5.....                          | 10.83  |    |
|       | 11600    | Fabric Cover for OP-5.....                              | 10.00  | 58 |
| OP-6  | 11202    | Portable amplifier less vu meter.....                   | 95.00  |    |
|       | MI-11214 | Battery box for OP-6 (including cable).....             | 25.00  |    |
|       | 11251    | vu meter kit for OP-6.....                              | 40.00  |    |
|       |          | Set of tubes for OP-6.....                              | 8.30   |    |
|       |          | Fabric cover for OP-6.....                              | 8.00   |    |
| 62-A  | {4221-B  | Portable Amplifier (Hubbell Sockets) }<br>Power Unit    | 175.00 | 59 |
|       | {4306    |                                                         |        |    |
| 62-A  | {4221-C  | Portable Amplifier (Cannon Sockets) }<br>Power Unit     | 200.00 | 59 |
|       | {4306    |                                                         |        |    |
|       |          | One set of tubes for 62-A.....                          | 20.53  | 59 |
|       | 4221-B   | 62-A Amplifier <i>only</i> (Hubbell Sockets).....       | 130.00 | 59 |
|       | 4221-C   | 62-A Amplifier <i>only</i> (Cannon Sockets).....        | 155.00 | 59 |
|       |          | One set of tubes for Amplifier Unit.....                | 16.00  | 59 |
|       | 4306     | 62-A Power Unit <i>only</i> .....                       | 50.00  | 59 |
|       |          | One set of tubes for Power Unit.....                    | 4.53   | 59 |
|       | 4307     | Battery Box for 62-A.....                               | 12.00  | 59 |

**BROADCAST TRANSMITTERS**

|         |        |                                                                             |                |    |
|---------|--------|-----------------------------------------------------------------------------|----------------|----|
| 250-D   | 7131   | 250 Watt Transmitter.....                                                   | On application | 66 |
| 100-H   | 7004   | 100 Watt Transmitter (Same as 250-D except tube complement)                 | On application | 66 |
| 1-E     | 7122   | 1000 Watt Transmitter.....                                                  | On application | 67 |
| 5-D     | 7212-A | 5000 Watt Transmitter.....                                                  | On application | 68 |
| 10-D    | 7304   | 10,000 Watt Transmitter.....                                                | On application | 69 |
| 5-DX    | 7232   | 5000 Watt Transmitter.....                                                  | On application | 70 |
| ....    | 7467   | Extra crystal, holder and thermostat assembly for 250-G,<br>100-G, 1-G..... | On application | 70 |
| 50-D    | 7351   | 50,000 Watt Transmitter.....                                                | On application | 72 |
| 250-G   | 7130   | 250 Watt Transmitter.....                                                   | On application | 75 |
| 100-G   | 7003   | 100 Watt Transmitter (same as 250-G except tube complement)                 | On application | 75 |
| 1-G     | 7123   | 1000 Watt Transmitter.....                                                  | On application | 75 |
| ....    | 7127   | Power change panel for 1-G transmitter.....                                 | On application | 76 |
| ET-4315 | 7005   | Battery Operated, 15 Watt Mobile UHF Transmitter.....                       | On application | 77 |
| ET-4315 | 7006   | AC Operated, 15 Watt Mobile UHF Transmitter.....                            | On application | 77 |
| 250-K   | 7242   | 250 Watt Transmitter.....                                                   | On application |    |

**TRANSMITTER ACCESSORIES**

|         |        |                                                           |                |     |
|---------|--------|-----------------------------------------------------------|----------------|-----|
| ....    | 7113-A | Line Voltage Control Unit.....                            | On application | 79  |
| AZ-4293 | 7423   | 1 KW. Antenna Tuning Unit.....                            | 275.00         | 79  |
| 92-A    | 7112   | Lighting Choke Coil, less condensers and transformer..... | 30.00          | 79  |
| 105     | 7444   | 5 KW. Antenna Tuning Unit.....                            | On application | 80  |
|         | 7237   | Supervisory Control Console.....                          | On application | 81  |
|         |        | Quartz crystals and holders.....                          | On application | 108 |

**CATHODE RAY OSCILLOGRAPHS**

|       |           |                                                               |          |    |
|-------|-----------|---------------------------------------------------------------|----------|----|
| 304-A | 8201      | 9" Cathode Ray Oscillograph, including 1 set tubes.....       | 440.00   | 89 |
| 305-A | 8200      | 9" Special Cathode Ray Oscillograph, including 1 set tubes... | 2,225.00 | 90 |
|       | Stock 160 | 5" Cathode Ray Oscillograph, including 1 set tubes.....       | 130.00   | 90 |

| Type Number    | Master Item No. |                                                          | Net Price | Catalog Page |
|----------------|-----------------|----------------------------------------------------------|-----------|--------------|
|                | 4656            | Brushed Chrome "J" trim for 9-AZ Rack.....               | \$35.00   | 50           |
|                | 4658            | Brushed Chrome "U" trim for 9-AZ Rack.....               | 15.00     | 50           |
|                | 4524-A          | "U" Strips for 9-AX Rack, (Three RCA Finishes) each..... | 5.00      | 50           |
|                | 4537-A          | "J" Strips for 9-AX Rack, (Three RCA Finishes) each..... | 5.00      | 50           |
| <b>35-AA</b>   | 4540-A          | †Deluxe Shelf (Black Finish).....                        | 20.00     | 50           |
| <b>35-B</b>    | 4541            | †Standard Shelf (Black Finish).....                      | 25.00     | 50           |
| <b>35-C</b>    | 4542            | †Standard Shelf (Black Finish).....                      | 30.00     | 50           |
|                | 4590            | Blank Panel ( 1-23/32" Width) (Three RCA Finishes).....  | 1.50      | 50           |
|                | 4598            | Blank Panel ( 2-1/8" Width) (Three RCA Finishes).....    | 1.50      | 50           |
|                | 4599            | Blank Panel ( 2-3/8" Width) (Three RCA Finishes).....    | 1.50      | 50           |
|                | 4589            | Blank Panel ( 3-3/32" Width) (Three RCA Finishes).....   | 1.50      | 50           |
|                | 4591            | Blank Panel ( 3-15/32" Width) (Three RCA Finishes).....  | 1.50      | 50           |
|                | 4592            | Blank Panel ( 5-7/32" Width) (Three RCA Finishes).....   | 2.00      | 50           |
|                | 4593            | Blank Panel ( 6-31/32" Width) (Three RCA Finishes).....  | 2.00      | 50           |
|                | 4594            | Blank Panel ( 8-23/32" Width) (Three RCA Finishes).....  | 2.50      | 50           |
|                | 4595            | Blank Panel (10-15/32" Width) (Three RCA Finishes).....  | 2.50      | 50           |
|                | 4596            | Blank Panel (12-7/32" Width) (Three RCA Finishes).....   | 3.25      | 50           |
| <b>56-B</b>    | 4167-A          | †Variable Line Equalizer (Black Finish).....             | 95.00     | 51           |
| <b>56-C</b>    | 4168            | Fixed Line Equalizer.....                                | 15.00     | 51           |
| <b>56-D</b>    | 4169            | †Variable Equalizer (Black Finish).....                  | 150.00    | 51           |
| <b>56-E</b>    | 4162            | †Line Equalizer (Black Finish).....                      | 40.00     | 51           |
| <b>XT-2830</b> | 4903            | Microphone Input Transformer.....                        | 20.00     | 52           |
| <b>XT-2771</b> | 4902            | Mixing Transformer.....                                  | 15.50     | 52           |
| <b>XT-2769</b> | 4900            | Line Transformer.....                                    | 14.00     | 52           |
| <b>XT-2770</b> | 4901            | Bridging Transformer.....                                | 15.50     | 52           |
| <b>XT-2831</b> | 4904            | Loudspeaker Transformer.....                             | 10.00     | 52           |
|                | 4308-A          | Relay Rectifier, 12 volt, 1 amp. (Black).....            | 40.00     | 52           |
|                | 4308-C          | Relay Rectifier, 12 volt, 1 amp (Umber Gray).....        | 40.00     | 52           |
|                |                 | One set of tubes for MI-4308 (Stock No. 20801).....      | 4.00      | 52           |
| <b>64-B</b>    | 4400B/4410      | Cabinet (Black Finish) with Speaker Unit.....            | 70.00     | 53           |
| <b>64-B</b>    | 4400C/4410      | Cabinet (Walnut Finish) with Speaker Unit.....           | 75.00     | 53           |
| <b>64-B</b>    | 4400/4410       | Cabinet (Umber Gray Finish) with Speaker Unit.....       | 70.00     | 53           |
| <b>64-B</b>    | 4400A/4410      | Cabinet (Transmitter Gray) with Speaker unit.....        | 70.00     | 53           |
| <b>64-B</b>    | 4405-A          | Base Cabinet (Transmitter Gray).....                     | 20.00     | 53           |
| <b>64-B</b>    | 4405            | Base Cabinet (Umber Gray).....                           | 20.00     | 53           |
| <b>64-B</b>    | 4405-B          | Base Cabinet (Black).....                                | 20.00     | 53           |
| <b>64-B</b>    | 4405-C          | Base Cabinet (Walnut).....                               | 22.50     | 53           |
|                | 4410            | Speaker Unit for 64-B (Permanent Magnet) (Unmounted)...  | 24.00     | 53           |
|                | 4466-A          | Speaker Unit for 64-A (110 V. Field) (Unmounted).....    | 20.00     | 53           |
|                | 4467            | Speaker Unit for 64-A (56 V. Field) (Unmounted).....     | 20.00     | 53           |
|                | 4433            | °Grill and Diffuser for 64-A (Black finish).....         | 10.75     | 53           |
|                | 4431            | Grill and Diffuser for 64-A (Umber Gray finish).....     | 10.75     | 53           |
| <b>64-A</b>    | 4437            | °Base Cabinet for 64-A (Black Finish).....               | 20.00     | 53           |
| <b>79-A</b>    | 4354            | Field Supply Unit (110 Volt).....                        | 17.50     | 53           |
| <b>UZ-4209</b> | 4460            | Loudspeaker Unit (unmounted).....                        | 15.00     | 53           |
| <b>UZ-4309</b> | 4461-A          | Loudspeaker Unit (unmounted).....                        | 20.00     | 53           |
|                | 32200           | Cueing Speaker (unmounted).....                          | 7.95      | 53           |
|                | 6294            | Cueing Speaker housing (Walnut Finish).....              | 5.35      | 53           |

### TRANSCRIPTION TURNTABLE EQUIPMENT

|               |         |                                                           |        |    |
|---------------|---------|-----------------------------------------------------------|--------|----|
| <b>70-C</b>   | 4871    | Transcription Turntable (Black & Silver) 60 cycle.....    | 325.00 | 54 |
| <b>70-C</b>   | 4871-A  | Transcription Turntable (Umber Gray) 60 cycle.....        | 325.00 | 54 |
| <b>70-C</b>   | 4872    | Transcription Turntable (Black & Silver) 50 cycle.....    | 340.00 | 54 |
| <b>71-B-1</b> | 4852-B  | Vertical Tonearm Attachment for 70-A and 70-B.....        | 95.00  | 55 |
| <b>71-C</b>   | 4867    | Vertical Tonearm Attachment for 70-C.....                 | 95.00  | 54 |
|               | 4855    | Booster Kit for Vertical Tonearms, Complete.....          | 62.50  | 55 |
|               | 4171-25 | Pad (16 db. 250 ohm).....                                 | 5.50   | 55 |
|               | 4868    | Hardware.....                                             | 5.00   | 55 |
|               | 4303    | Power Supply.....                                         | 23.50  | 55 |
|               | 11207   | 85-B Pre-Amplifier, less tubes (see listing page 42)..... |        |    |
|               | 4898    | Frequency Equalizer Kit for 71-A and 71-B.....            | 10.00  | 55 |
| <b>72-C</b>   | 4877    | Recording Attachment.....                                 | 120.00 | 55 |
|               | 4876    | Outside in lead screw for 72-C.....                       | 25.00  |    |
|               | 4899    | Extra Mounting Base for 72-C.....                         | 5.50   |    |

† For Umber Gray or Transmitter Gray Finish, add \$2.50.

° For Transmitter Gray Finish, add \$1.50.

| Type Number                     | Master Item No. | SPEECH INPUT EQUIPMENT (continued)                             | Net Price          | Catalog Page |
|---------------------------------|-----------------|----------------------------------------------------------------|--------------------|--------------|
|                                 | 11703           | Speaker relay for 76-B-1.....                                  | 8.00               |              |
| 81-A                            | 4647-A          | Control Console (78-B Type) (Black).....                       | 325.00             | 29           |
| 81-B                            | 4647-B          | Control Console (78-C Type) (Black).....                       | 300.00             | 29           |
|                                 | MI-63           | Interconnecting Cable twisted pair shielded (solid conductor)  | 23.00 per 1000 ft. |              |
|                                 | MI-64           | Interconnecting Cable twisted pair shielded stranded conductor | 33.00 per 1000 ft. |              |
|                                 | 11500           | Wall Mounting Jack and Equalizer Cabinet (Umber Gray)..        | 40.00              | 29           |
| <b>SPEECH INPUT UNITS</b>       |                 |                                                                |                    |              |
| 41-C                            | 4206            | †Three-Channel Pre-Amplifier, less tubes (Black).....          | 200.00             | 32           |
|                                 |                 | One set of tubes for 41-C.....                                 | 28.50              | 32           |
| 40-D                            | 4295-A          | †Program Amplifier, less tubes (Black).....                    | 250.00             | 33           |
|                                 |                 | One set of tubes for 40-D.....                                 | 13.79              | 33           |
| 55-B                            | 4214            | †Bridging Amplifier, less tubes (Black).....                   | 225.00             | 34           |
|                                 |                 | One set of tubes for 55-B.....                                 | 6.65               | 34           |
| 94-D                            | 4270            | †Monitoring Amplifier, less tubes (Black).....                 | 135.00             | 35           |
|                                 |                 | One set of tubes for 94-D.....                                 | 22.75              | 35           |
| 96-AX                           | {11201-A        | †Limiting Amplifier, including one set of tubes } & VU meter   | 475.00             | 36           |
|                                 | {11300          | °Power Supply Unit, including one set of tubes } (Black)       |                    |              |
|                                 | 11250           | Matched pair 6K7 tubes for 96-A.....                           | 2.70               | 36           |
|                                 |                 | One set of tubes for 96-A, less matched 6K7's.....             | 8.13               | 36           |
| 15-C                            | 4398            | †Illuminated Meter Panel (Black).....                          | 60.00              | 37           |
| 46-B                            | 4152            | †Mixer and Switching Panel (Black).....                        | 130.00             | 37           |
| 15-B                            | 4390-A          | †Meter Panel (Black).....                                      | 40.00              | 39           |
| 15-D                            | 4388            | °Meter Panel.....                                              | 35.00              | 39           |
| 41-B                            | 4205-E          | °Pre-Amplifier, incl. filament transformer, less tubes (Black) | 50.00              | 39           |
|                                 |                 | One set of tubes for 41-B.....                                 | 9.50               | 39           |
| 40-C                            | 4292-C          | †Program Amplifier, less tubes (Black).....                    | 175.00             | 40           |
|                                 |                 | One set of tubes for 40-C.....                                 | 13.75              | 40           |
| 85-B                            | 11207           | Pre-Amplifier, less tubes.....                                 | 40.00              | 42           |
|                                 |                 | One set of tubes for 85-B.....                                 | 2.50               | 42           |
| 85-X                            | 11208           | Single Stage Isolation Amplifier.....                          | 50.00              | 43           |
|                                 |                 | One set of tubes for 85-X.....                                 | 2.50               | 43           |
| RT-386                          | 11606           | Filament transformer.....                                      | 6.00               | 44           |
|                                 | 11302           | Power Supply for preamplifier.....                             | 60.00              | 44           |
|                                 | 4303            | Power Supply for preamplifier.....                             | 23.50              | 44           |
| 84-B                            | 11204           | Program and Line Amplifier, less tubes.....                    | 125.00             | 45           |
|                                 |                 | One set of tubes for 84-B.....                                 | 10.30              | 45           |
| 82-B                            | 11205           | Monitoring Amplifier, less tubes.....                          | 85.00              | 46           |
|                                 |                 | One set of tubes for 82-B.....                                 | 13.75              | 46           |
|                                 | 4313-A          | Compensating Network for 82-B.....                             | 4.00               | 46           |
|                                 | 11203           | Filter Kit for 82-B (for preamplifier supply).....             | 15.00              | 46           |
| 83-C                            | 11206-B         | Line and Isolation Amplifier, less tubes.....                  | 100.00             | 46           |
|                                 |                 | One set of tubes for 83-C.....                                 | 6.65               | 46           |
| 36-A                            | 4681-C          | Panel and Shelf (Three RCA Finishes).....                      | 28.00              | 47           |
|                                 | 11701           | Plate Current Switch.....                                      | 2.75               | 47           |
|                                 | 11700           | Plate Current Indicating Meter, Illuminated Streamlined case   | 35.00              | 47           |
| 36-B                            | 4682            | °Panel and Shelf (Three RCA Finishes).....                     | 15.00              | 47           |
|                                 | 11501           | °Single Jack Mat (Black).....                                  | 7.00               | 49           |
|                                 | 11502           | °Double Jack Mat (Black).....                                  | 7.50               | 49           |
|                                 | 11503           | °Triple Jack Mat (Black).....                                  | 8.00               | 49           |
| <b>SPEECH INPUT ACCESSORIES</b> |                 |                                                                |                    |              |
| 57-B                            | 4399            | °Switch and Fuse Panel.....                                    | 18.00              | 49           |
| 33-A                            | 4645            | Jack Panel.....                                                | 42.00              | 49           |
| 33-B                            | 4646            | Jack Panel.....                                                | 22.00              | 49           |
|                                 | 4652-2A         | Patch Cord 2 ft. (Gray).....                                   | 9.00               | 49           |
|                                 | 4652-4          | Patch Cord 4 ft.....                                           | 9.25               | 49           |
|                                 | 4652-6          | Patch Cord 6 ft.....                                           | 9.50               | 49           |
| 9-AJX                           | 4519/4537       | * Cabinet Rack including 2 MI-4537-A "J" Strips.....           | 95.00              | 50           |
| 9-AUX                           | 4519/4524       | * Cabinet Rack including 1 MI-4524-A "U" Strip.....            | 90.00              | 50           |
| 9-AJZ                           | 4519/4656       | * Cabinet Rack including 4 brushed chrome "J" Strips and trim  | 118.00             | 50           |
| 9-AUZ                           | 4519/4658       | * Cabinet Rack including brushed chrome "U" Strips and trim.   | 100.00             | 50           |

° For Umber Grayor Transmitter Gray, add \$1.50.

† For Umber Gray or Transmitter Gray, add \$3.00.

| Type Number | Master Item No. | MICROPHONES                                                | Net Price   | Catalog Page |
|-------------|-----------------|------------------------------------------------------------|-------------|--------------|
| 44-BX       | 4027-B          | Standard Velocity Microphone*.....                         | \$65.00     | 8            |
| 74-B        | 4036-G          | Junior Velocity Microphone*.....                           | 19.00       | 9            |
| 77-B1       | 4043            | Uni-directional Velocity Microphone*.....                  | 50.00       | 10           |
| 77-C1       | 4044            | All Purpose Microphone (250 ohms)*.....                    | 60.00       | 11           |
| 77-C        | 4042-B          | All Purpose Microphone (50 ohms)*.....                     | 60.00       | 11           |
| 88-A        | 4048-A          | Pressure Microphone*.....                                  | 27.75       | 12           |
|             | 4015            | High Level Talk-Back Microphone with "press to talk" stand | 28.00       | 13           |
|             | 6226D/6227      | Aerodynamic Microphone, 30 foot cable and stand.....       | 11.80       | 13           |
| 30-A        | 4001-B          | Lapel Microphone, 25' ft. cable, Hubbell plug.....         | 14.50       | 14           |
| PB-112-B1   | 2052-B/2062     | Sound Power Handset, each, 6 ft. cable.....                | 33.75       | 14           |
|             | MI-62           | Microphone cable (44-BX).....                              | 11c per ft. | 14           |
|             | MI-59           | Microphone cable (74-B, 77-B, 77-C and 88-A).....          | 8c per ft.  | 14           |

\* Including 30' shielded rubber cable, less plug.

### CANNON PLUG AND RECEPTACLES

|           |        |                                        |      |    |
|-----------|--------|----------------------------------------|------|----|
| P3-CG-12S | 4630   | Male plug to fit P3-35 Receptacle..... | 2.35 | 14 |
| P3-35     | 4624-A | Wall Receptacle (no cover).....        | 5.50 | 14 |
| P3-CG-11S | 4620   | Female Connector for P3-CG-12S.....    | 4.00 | 14 |

### STANDS

|         |        |                                  |       |    |
|---------|--------|----------------------------------|-------|----|
| 90-A    | 4090   | DeLuxe Program Stand.....        | 22.50 | 15 |
| 90-C    | 4094   | DeLuxe Boom Stand.....           | 54.00 | 15 |
| 91-A    | 4058-A | Desk Stand.....                  | 5.50  | 15 |
| AP-4234 | 4060-B | Adaptor for 91-A.....            | 3.00  | 15 |
|         | 4068-A | Light Program Stand.....         | 6.90  | 15 |
|         | 4065-B | Banquet Stand.....               | 3.75  | 15 |
| 59-A    | 4059-A | Collapsible, portable stand..... | 20.00 | 15 |
| 91-B    | 4092   | Desk Stand.....                  | 5.50  | 15 |
|         | 4089   | Cable hook for 90-A.....         | 3.50  |    |

### SPEECH INPUT EQUIPMENT

#### Factory Assembled Equipment

|        |   |         |                                                                                                                            |          |    |                                                          |       |    |
|--------|---|---------|----------------------------------------------------------------------------------------------------------------------------|----------|----|----------------------------------------------------------|-------|----|
| 78-B-1 | { | 4296-C  | Two Studio Speech Input Equipment Rack and Control Console and Relay Rectifier — less tubes (Black Finish).....            | 1,700.00 | 24 |                                                          |       |    |
|        |   | 4647-C  |                                                                                                                            |          |    |                                                          |       |    |
|        |   | 4308-A  |                                                                                                                            |          |    | One set of tubes for 78-B-1.....                         | 65.04 | 24 |
| 78-B-1 | { | 4296-D  | Same, finished in Umber Gray and Same, finished in Umber Gray and Same, finished in Umber Gray.....                        | 1,700.00 | 24 |                                                          |       |    |
|        |   | 4647-D  |                                                                                                                            |          |    |                                                          |       |    |
|        |   | 4308-C  |                                                                                                                            |          |    |                                                          |       |    |
| 78-C-1 | { | 4296-E  | Single Studio Speech Input Equipment Rack and Control Console and Relay Rectifier — less tubes (Black Finish).....         | 1,625.00 | 25 |                                                          |       |    |
|        |   | 4647-E  |                                                                                                                            |          |    |                                                          |       |    |
|        |   | 4308-A  |                                                                                                                            |          |    | One set of tubes for 78-C-1.....                         | 65.04 | 25 |
| 78-C-1 | { | 4296-G  | Same, finished in Umber Gray and Same, finished in Umber Gray and Same, finished in Umber Gray.....                        | 1,625.00 | 25 |                                                          |       |    |
|        |   | 4647-G  |                                                                                                                            |          |    |                                                          |       |    |
|        |   | 4038-C  |                                                                                                                            |          |    |                                                          |       |    |
| 80-AX  | { | 11605-D | Two Studio Control Desk (Black Finish). <i>Uses vu Meter.</i> Including Relay Rectifier. Less tubes.....                   | 1,525.00 | 26 |                                                          |       |    |
|        |   | 4308-A  |                                                                                                                            |          |    | One set of tubes for 80-AX.....                          | 48.86 | 26 |
| 80-AX  | { | 11605-E | Two Studio Control Desk (Umber Gray Finish). <i>Uses vu Meter.</i> Including Relay Rectifier. Less tubes.....              | 1,525.00 | 26 |                                                          |       |    |
|        |   | 4308-C  |                                                                                                                            |          |    |                                                          |       |    |
| 80-B   | { | 11604   | Single Studio Control Desk (Black Finish). Including Relay Rectifier. Less tubes.....                                      | 1,050.00 | 27 |                                                          |       |    |
|        |   | 4308-A  |                                                                                                                            |          |    | One set of tubes for 80-B.....                           | 43.71 | 27 |
| 80-BX  | { | 11604-B | Single Studio Control Desk (Black Finish). <i>Uses vu Meter.</i> Including Relay Rectifier. Less tubes.....                | 1,100.00 | 27 |                                                          |       |    |
|        |   | 4308-A  |                                                                                                                            |          |    |                                                          |       |    |
| 80-BX  | { | 11604-C | Single Studio Control Desk (Umber Gray Finish). <i>Uses vu Meter.</i> Including MI-4308-C Relay Rectifier. Less tubes..... | 1,425.00 | 27 |                                                          |       |    |
|        |   | 4308-C  |                                                                                                                            |          |    |                                                          |       |    |
| 76-B-1 | { | 11613   | Two Studio Console Speech Input Equipment, less tubes, inc. Power Supply for 76-B-1 less tubes (Umber Gray).....           | 825.00   | 28 |                                                          |       |    |
|        |   | 11301-A |                                                                                                                            |          |    | One set of tubes for 76-B-1.....                         | 39.25 | 28 |
|        |   | 11702   |                                                                                                                            |          |    | Light Relay for 76-B-1, 80-A, 80-B, 78-B1 and 78-C1..... | 8.00  |    |



# BROADCAST STATION EQUIPMENT PRICE LIST

Apparatus prices have been arranged in the order of listing in the catalog and are indexed to the catalog pages. In order to find any item by type number, please refer to the catalog index and then consult this list in accordance with the page number.

Prices listed herein are net to broadcasting stations on purchases made directly from the RCA Manufacturing Company, Inc., or through its own field offices. Prices are quoted f.o.b. point of manufacture (Camden, N. J., for transmitting equipment and microphones; Indianapolis, Ind., for most speech input equipment; Harrison, N. J., for transmitting or special purpose tubes, unless a nearer district warehouse is specified). Prices are subject to change after 30 days from the above date and the manufacturer reserves the right to modify apparatus from the printed specification. Equipment will be shipped by the carrier requested whenever feasible although vacuum tubes will be shipped by express only, except under special circumstances. Prices on other equipment not listed herein may be obtained from field representatives.

**NOTES:** Master Item numbers used to identify apparatus on invoices and packing slips are given for each unit.

## CATALOG ERRATA

- Page 13—Aerodynamic Microphone Change to MI-6226D. 30 foot cable.
- Page 28—Type 76-B1 Console Supersedes 76-B.
- Page 49—57-B supersedes 57-A Switch and fuse panel.
- Page 50—Type 9-A, 9-B, 9-C and 9D racks no longer carried in stock.
- Page 53—Field Supply change to 79A.
- Page 53—64-B supersedes 64-AX Loudspeaker.
- Page 56—Omit MI-4857 Lateral tone arm kit.
- Page 90—Change reference 305-A Oscillograph from page 15 to 101.
- Page 94—Change reference No. 9796 Transformer from page 19 to 105.
- Page 94—MI-1520 Filament Supply Unit no longer carried in stock.

## ADDITIONS

- Page 15—MI-4089 Cable hook for 90-A stand.
- Page 26—Type 80-AX Two Studio Control Desk with VU Meter.
- Page 27—Type 80-BX Single Studio Control Desk with VU Meter.
- Page 28—MI-11702 "On Air" Light Relay for 76-B1, 80-A and 78-B1.
- Page 28—MI-11703 Extra Speaker Relay for 76-B1.
- Page 43—Type 83-C Line Amplifier.
- Page 58—Type OP-5X Remote Amplifier with vu Meter.
- Page 59—Type OP-6 Remote Amplifier.
- Page 99—Type 300-A Three Element Array Kit.
- Page 106—Type 311-A Broadcast Frequency Monitor.
- Page 106—Type 312-A RF Noise Meter.
- Page 29—Type MI-63 Interconnecting Cable, Twisted Pair Shielded (Solid Conductor).
- Page 29—Type MI-64 Interconnecting Cable, Twisted Pair Shielded (Stranded Conductor).



