



MARCONI
INSTRUMENTATION

*A Technical Information Bulletin
Issued Quarterly by
Marconi Instruments Limited, St. Albans, England*

IN THIS ISSUE

MODULAR ELECTRONIC INSTRUMENTS	page 25
A.F. OSCILLATOR, TYPE TF 2100	„ 28
M.F. OSCILLATOR, TYPE TF 2101	„ 34
THREE A.F./M.F. ATTENUATORS	„ 36
A.F. AND M.F. SIGNAL SOURCES, TYPE TF 2000 AND TF 2001	„ 43
IMPEDANCE MEASUREMENTS AND THE IN SITU COMPONENT BRIDGE, TYPE TF 2701	„ 46

ELECTRONIC INSTRUMENTS FOR TELECOMMUNICATIONS AND INDUSTRY

MARCONI INSTRUMENTATION

Issued with
the compliments of

MARCONI INSTRUMENTS
LIMITED

ST. ALBANS

ENGLAND

EDITORS

P. M. RATCLIFFE, A.M.I.E.E.

and

J. R. HAYWARD, A.M.Brit.I.R.E.

Modular Electronic Instruments

MARCONI INSTRUMENTS LTD. currently manufacture a range of about 100 types of electronic measuring instruments together with a large number of accessories. Quantities of individual types vary from a few to a maximum of about 1,000 per year and their cost from about £50 for relatively simple units to over £1,000 for the most complex.

Development of new or improved designs is continually taking place in order to keep ahead in an environment of rapid technical change. Conditions imposed by the diversity of our products coupled with the relatively small quantity production lead to difficulties in design and production which are reflected both in the character of the product and in price. In order therefore to achieve a successful product policy which can overcome these limitations it has been found necessary to rationalize mechanical design techniques on a broad basis so that a considerable reduction of variety is taking place, not in user facilities, but in component parts and sub-assemblies.

The effect of this is to permit manufacture of component parts in larger quantities. Design time is saved, more effort is available for design improvement, and the incorporation of like components throughout the product range leads to a unity of style. There are many other advantages which follow such as the availability of accessories, facilities for system construction, and better after-sales service.

Dimensions

The first step in a programme of rationalization is to determine common factors. It was apparent that for the range of electronic instruments under consideration the main features are packaging of electronic components and circuitry and the presentation of controls and display. All units would be required in portable or transportable form with alternative facilities for systems construction.

In view of the universal acceptance of the standard 19-in. rack system it was decided at the outset to take this as the primary standard for a new modular system. Consequently the following unit dimensions were specified:

height	1.75 in. (4.445 cm)
width	2.854 in. (7.249 cm)
depth	3 in. (7.62 cm)

From these basic dimensions a range of instrument sizes was determined. Six units of width (i.e. $17\frac{1}{8}$ in.) was adopted as the standard width corresponding to a conventional 19-in. rack mounting chassis. Small instruments have widths of one, two or more units and it has been found that the most convenient height is 7 in. (4 units) and depth 9 in. (3 units). These are available in portable form but may be readily assembled into a rack system. Standard width instruments range up to 10 units in height and up to 5 units in depth, but although a wide range of sizes is available, only a selected few have been required up to the present time.

Instrument Cases

A range of instrument case and panel assemblies has been designed on the modular concept outlined. All sizes utilize the same gauge of material and the same manufacturing methods. They are designed to use simple sheet metal forms which eliminate welding and hand work, making possible the application of improved finishes.

The copyright of all articles is strictly reserved but the material may be reprinted without permission providing definite acknowledgement is made to Marconi Instruments Limited

All fixings are concealed except those required for the removal of covers. The panel surround is formed from an alloy extrusion, only one size of section being required throughout the range. A feature of the panel assembly is the introduction of an escutcheon plate which is located between the support panel and the surround. This facilitates the printing of the panel legend and makes possible the adaptation of basic chassis assemblies to a variety of instruments by concealing control positions provided for alternative versions. Because of the reduction in size due to the widespread introduction of transistor circuitry it was not thought desirable to recess the front panel or to provide side rails for the protection of controls as these tend to form an obstruction in operation.

The component parts of the assembly are used in various combinations to reduce piece part variety. For instance, one panel assembly and rear cover can be used for any depth, and one size of base plate can be used for any height. Fixings, feet, tilting attachment and handles are standardized throughout. All assemblies have the option of ventilation if required.

Accessories

In addition to the tilting bracket which is used on the smaller units to adjust the instrument to a convenient working height, accessories are available which increase the usefulness of the equipment.

All the new modular units may be mounted in standard 19-in. racks for use in systems. Standard width units can be supplied with side brackets and dust covers. Fitting these is extremely simple and the conversion is easily carried out by the user if required. The brackets, which carry panel rails, extend the panels to the standard width of 19 in. and the complete assembly is compatible with Services transit equipment and international standard rack equipment.

Because smaller instruments are based on a fixed height and depth, and their width is a multiple of one-sixth of the standard width, one standard rack mounting case is suitable for any unit or combination of units up to a maximum of six. This case is mounted to the rack in the normal manner. Instruments are inserted from the front and secured by screws at the rear.

For those instruments with pairs of input and/or output terminals, shielded adaptors are available to convert to a coaxial form.

Components

In parallel with the rationalization of instrument sizes and case construction a range of components was designed comprising control knobs, dial assemblies, meters, terminals and chassis parts.

The modular principle was used in the design of a range of control knobs in order to provide the greatest utility with the minimum of piece part variation. In general, serrated knobs are used for adjustable controls and bar-type knobs are used for switches. Skirts or dials may be added where required. Skirts are transparent and may be printed on the reverse side with a legend or calibration to form a small indicator dial.

The advent of transistors has caused instrument assemblies to become more compact, but the scale length of indicating devices has to remain long enough to achieve the desired accuracy of reading, consequently the need arose for a more compact meter assembly. It was decided to reduce the area of the meter front to the minimum size, which led to the adoption of a clear moulded plastic front. The area occupied by this design is approximately 50% less than the type previously used with an equal scale length.

Many other component parts have also been redesigned to reduce piece part variety, size and cost but at

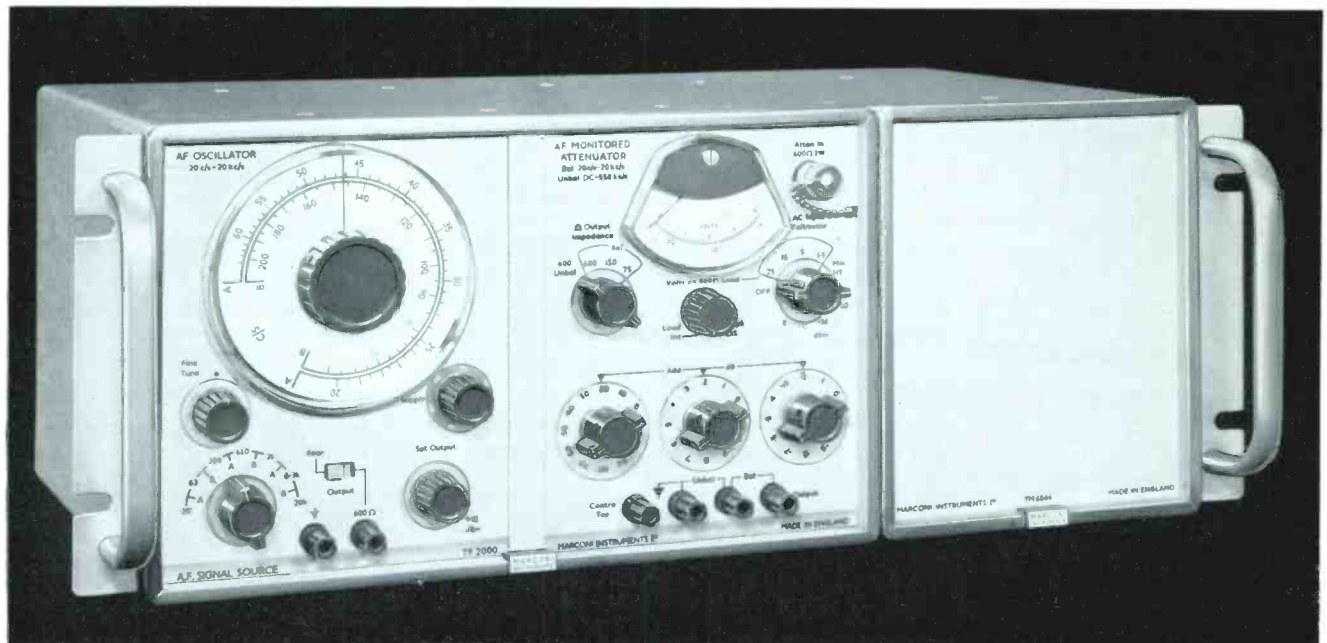

*Ergonomics in production.
A specially designed jig makes
for easier and therefore more
efficient wiring of the TF 2100
A.F. Oscillator*

the same time provide the maximum utility. Examples of this are die-cast chassis side frames, standardized power pack components, and printed circuit assemblies.

Instrument Assemblies

A range of instrument assemblies has been constructed on the modular system. A point of interest is that the modular concept is being developed to include families of units which have common basic features. Groups of individual instruments are designed so that they may be supplied separately or assembled in combined form as a packaged unit. For example, Basic Oscillators and Attenuators which are produced as separate instruments are also used to build various types of Signal Sources comprising an Oscillator and Attenuator. Alternatively a

3-unit assembly can be created by the user for special test purposes such as providing an intermodulation testing signal from a combination of M.F. Attenuator TF 2162 coupled to two Oscillators TF 2100 or TF 2101.

Each unit incorporates a standardized chassis construction consisting of two die-cast side frames hinged for component access as shown on page 31.

Not only are basic units combined to provide a variety of products. The basic units themselves are produced in several variations to cover different frequency ranges and with differing specifications so that from a relatively small number of basic designs a wide range of products is available. This principle is now being extended into the design of many other instruments manufactured by the Company. Oscilloscopes, for example, form a separate series of instruments owing to their somewhat specialized requirements, but standard panel components and finishes are used in conjunction with a special chassis assembly. The circuitry is constructed in functional units which enables various plug-in assemblies to be used to provide a number of versions of a basic instrument. Rack mounting facilities are arrived at by rearranging the sub-units in a different framework of a size suitable for this purpose.

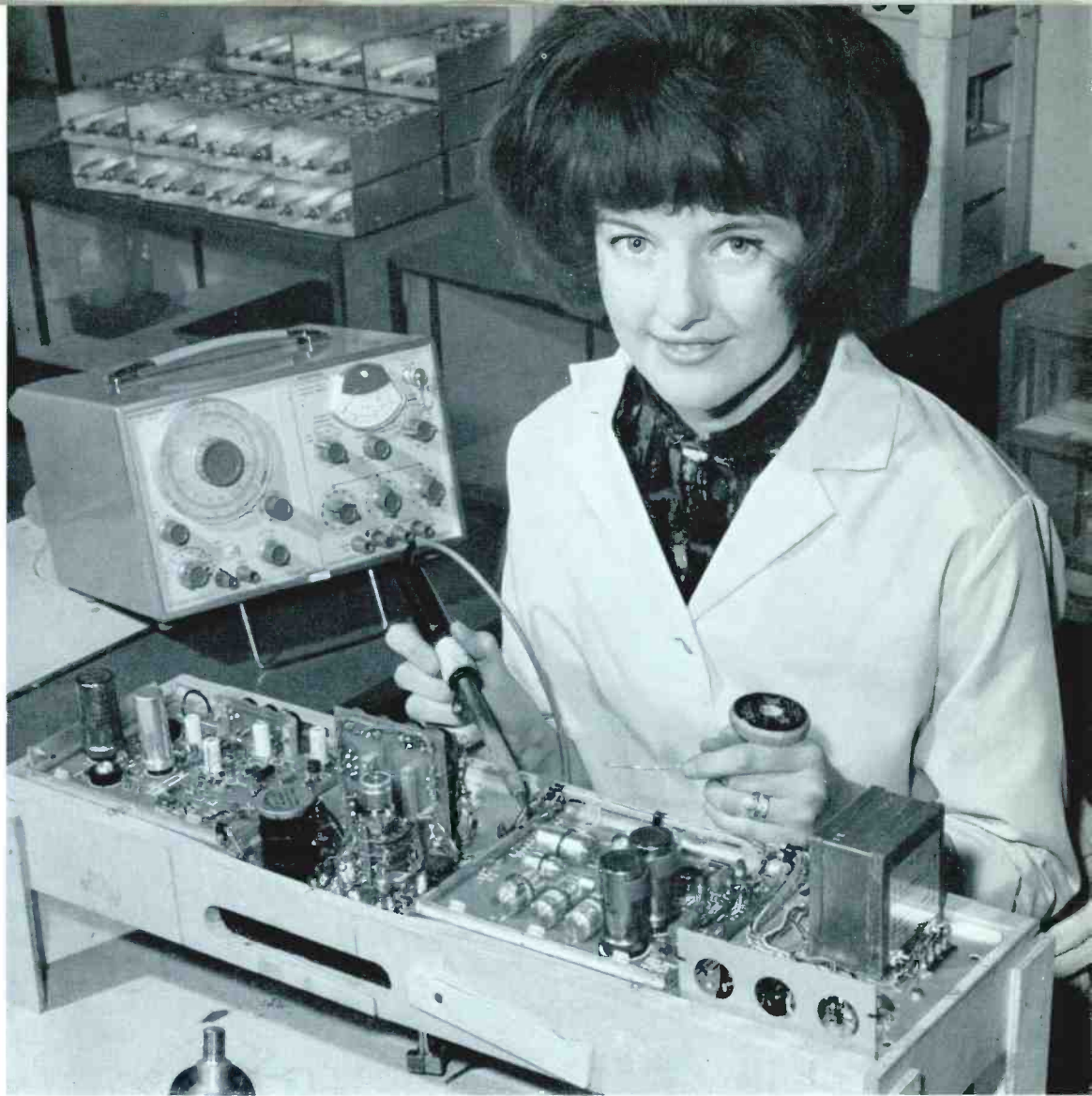

Industrial Design

The functional aspect is perhaps the most dominant design feature of these instruments, nevertheless elegant solutions to engineering problems have been sought within the limitations of price and quantity.

Panel layouts have been based on a work study to achieve the best ergonomic arrangement compatible with the electronic circuitry. The colours were chosen to provide an attractive finish which is in character with the product. Case parts are finished in blue-grey and panels in semi-matt pale grey contrasting well with the legend.

Working controls are identified with lower case legends which have improved recognition value over the type previously used. A survey has made possible the standardizations of titles, layout and abbreviations creating a uniformity of style which is necessary when various units may be combined together.

The form of the units described is dictated by the modular concept and accepted engineering standards, but the endeavour has been to interpret those requirements in a practical and simple way to meet the various conditions of use in laboratories, factories, in the field and for special purposes. W. D. CAIN, A.M.I.E.E., M.S.I.A.

A.F. Oscillator

TYPE TF 2100

by L. M. SARGENT

This small transistorized audio frequency oscillator provides over 8 V unloaded, or 4 V in a matched 600 Ω load over the range 20 c/s to 20 kc/s. The distortion factor does not exceed 0.05% from 63 c/s to 6.3 kc/s, or 0.1% elsewhere. Frequency accuracy and stability are high. The output voltage can be adjusted conveniently over a range of 100 : 1.

THE NEW Audio Frequency Oscillator TF 2100 is an instrument of conveniently small size, which develops a sine-wave of very low distortion in the audio frequency range. Its main applications lie in checking the performance of transmission apparatus concerned with the handling of high-fidelity entertainment programmes, and in assisting the design and testing of other low distortion equipment. Its good output frequency characteristic assists in response checking, and its high stability makes it useful for measurements involving bridges and filters.

The oscillator covers the range of 20 c/s to 20 kc/s in six bands. It will be seen from the photograph that the frequency scales are nearly linear, this being achieved by the use of non-linear tuning potentiometers. Thanks to

the linearity and the relatively small frequency cover, a better discrimination than on most small oscillators is achieved, a change of $\pm 1\%$ frequency being easily discernible; total scale length is about 36 in. It is necessary to use potentiometers for tuning, instead of the conventional variable capacitors, because of the reduced impedances of transistorized circuits. Allowance is made for the very slight frequency steps which are occasioned by the wire-wound potentiometers, by providing a FINE TUNING control giving some $\pm 0.2\%$ frequency variation at the low end of a band, and $\pm 0.6\%$ at the high end. The rated output is +15 dBm, which provides 4.36 V in a 600 Ω load, or some 8.5 V unloaded. The output voltage is a fraction of the fixed output of the oscillator, adjusted

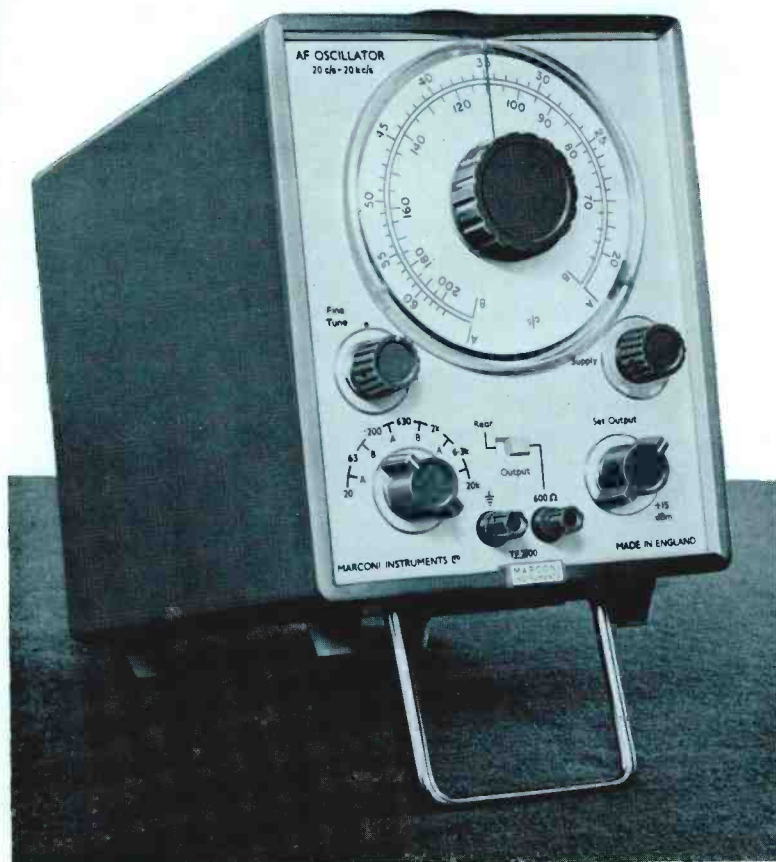

*Fig. 1.
Very low distortion is a feature of this small transistorized A.F. Oscillator, shown here with its tilting stand in use*

**SOME TYPICAL
CHARACTERISTICS
OF INTEREST**

**A.F. Oscillator
Type TF 2100**

Fig. 2.

FREQUENCY

<i>Long Term Stability:</i>	0.015% in 7 hours, 1 hour from cold.*
<i>Short Term Stability:</i>	0.003% in any 10 min as above.*
<i>Variation with Supply Volts:</i>	+0.0005% for shift 200 to 250 V at 20 kc/s.
<i>Temperature Coefficient:</i>	-0.01% per °C, from 10° to 35°C.
<i>Reaction to Application of Matched Load:</i>	+0.03% at 1 kc/s. +0.25% +0.1 c/s at frequency extremes.

AMPLITUDE

<i>Distortion Factor:</i>	0.02% from 200 c/s to 10 kc/s. 0.06% at 20 c/s, 0.04% at 20 kc/s.
<i>Supply Hum:</i>	0.002% at maximum output.
<i>Long Term Stability:</i>	2% in 7 hours, 1 hour from cold.*
<i>Short Term Stability:</i>	0.3% in any 10 min as above.*
<i>Variation with Supply Volts:</i>	+0.005% for shift 200 to 250 V.
<i>Temperature Coefficient:</i>	-0.4% per °C, from 10° to 35°C.
<i>Supply Frequency Beat:</i>	0.01% modulation close to 50 c/s.
<i>Time to settle within 1% after switching:</i>	7 sec at 20 c/s, less elsewhere.

* Brit.I.R.E. standard definitions, except that oscillators were subjected to unstabilized temperature and power supply.

by an uncalibrated variable T-pad, so that the distortion of the signal across the load does not vary with output level. Output impedance lies within some $\pm 20\%$ of 600 Ω at any level, and is very much closer at full output; d.c. resistance at the output is 100 k Ω , and up to ± 25 V d.c. can be applied without damage. The law of the output T-pad is such that the change of level in decibels is approximately linear with respect to the angle of rotation over some 40 dB range, so that signals down to about 50 mV can be set up by monitoring with a millivoltmeter, without the necessity for an external attenuator.

The r.m.s. distortion factor of the output signal is less than 0.1% (-60 dB) over the whole range of 20 c/s to 20 kc/s, and over the middle range of 63 c/s to 6.3 kc/s it is less than 0.05%. Supply hum is also very low, of the order of 80 dB below the signal. Being designed primarily for very low distortion, the circuit is not economical in the use of battery supplies, but the facility of switching over to an external d.c. supply is provided, since it can be very useful for occasional field tests, or especially for the odd test involving an audio source completely free from supply frequency hum. A heavy negative feedback loop, which is largely responsible for the low distortion, also provides exceptional frequency stability. This is also assisted by the power supply stabilization, applicable to both a.c. and d.c. supplies. A panel switch allows the output to appear either at the front panel, or at the rear of the instrument to facilitate racking interconnections, and the switch is also convenient for temporary removal of the signal without upsetting any parameter, as often required during tests.

The simplified circuit diagram of Fig. 3 shows that the system consists essentially of:

- a sustaining amplifier,
- a feedback system containing narrow-band positive feedback of adjustable frequency, and wide-band negative feedback which is level-conscious,
- an output attenuator of simple form.

Problems of Obtaining Low Distortion

The majority of commercial general-purpose resistance-capacitance oscillators employ a sustaining amplifier having a bandwidth roughly equal to the required band of output frequencies, and incorporating both positive and negative feedback paths, one of these paths being frequency-conscious in such a sense as to cause the net feedback to be negative except at some particular frequency. At this frequency the feedback causes oscillation. The control of level is provided by a power—or voltage—sensitive device which modifies the wide-range feedback, so rendering the net feedback less positive as the output level increases. The total feedback system reduces to a bridge, the output of which is the difference between the output from (a) a pair of arms having inverse reactance/resistance arrangements, and (b) a pair of resistive arms. Henceforward, the complex arms will be referred to as the reactive network.

The reactive networks used give an output in phase with the input, the output reaching either a maximum or minimum at the so-called 'tuned' frequency. Such outputs are used in oscillators as frequency-conscious positive or negative feedback respectively. The most popular networks so used are the two complex arms of a Wien bridge¹, and the capacitance bridged-T network². Wide-range feedback (the second of the two required paths) is invariably derived from a resistive potentiometer, one of

the two elements being modified in value by the output level. An amplifier with differential inputs must be used, and the number of phase reversals which the two signals undergo decides which of them promotes positive feedback and which one promotes negative feedback.

This differential effect is usually obtained by feeding to grid and cathode, or base and emitter, of an amplifier; and in either case the stage has reduced gain due to the unwanted current feedback caused by the load resistor in the circuit of the cathode or emitter. At the same time, this electrode presents a fairly heavy load, which ultimately demands a substantial alternating current from the output of the amplifier. Now, low gain and heavy loads are barriers in the way of achieving a pure output signal. The reactive network tends to cause a gain greater than unity at the 'tuned' frequency round the feedback system, either by providing a peak in the positive feedback, or by providing a trough in the negative feedback. The level-conscious device adjusts this gain to unity. At the output point, non-linearity in the amplifier will produce distortion of the sine-wave, but at the second and third harmonic frequencies, due to the frequency response of the reactive network, there will be net negative feedback, the effect of which will be to reduce the distortion. The magnitude of this negative feedback depends on the amount of gain available in excess of the transmission loss through the reactive network at resonance, and also on the change in the magnitude and phase of the transmission loss through the reactive net-

work at the harmonic frequencies with respect to the fundamental frequency.

There are two very important points to consider if heavy negative feedback is to be achieved. The first concerns spurious oscillation in amplifiers with negative feedback. To avoid such oscillation, it is necessary to keep the phase shift low over the range of frequencies in which the loop gain is high. The more amplifying stages there are, the greater the risk of spurious oscillation, and for the degree of distortion correction intended, it is highly desirable to have only a single time-constant involved. The roll-off of response will then occur at the rate of 6 dB per octave, with an ultimate phase angle of 90 degrees. This requirement indicates that a single stage of high gain must be employed. It should be noted, incidentally, that this problem and the one to follow can be dealt with more easily in oscillators providing a selection of fixed frequencies, rather than in those that are fully tunable. The second important point concerns the bridge. If the components in the reactive network have the exact values required, there will be a maximum or minimum output (as applicable) at the theoretical frequency, and in phase with the input. Thus, the complete bridge would be able to come to a perfect balance with zero output, which would be the value of input required by an ideal amplifier with infinite gain. However, if in practice the bridge, due to imperfections in the matching of components, is unable to provide a minimum small enough to equal the reciprocal of the actual gain of the amplifier, there will be

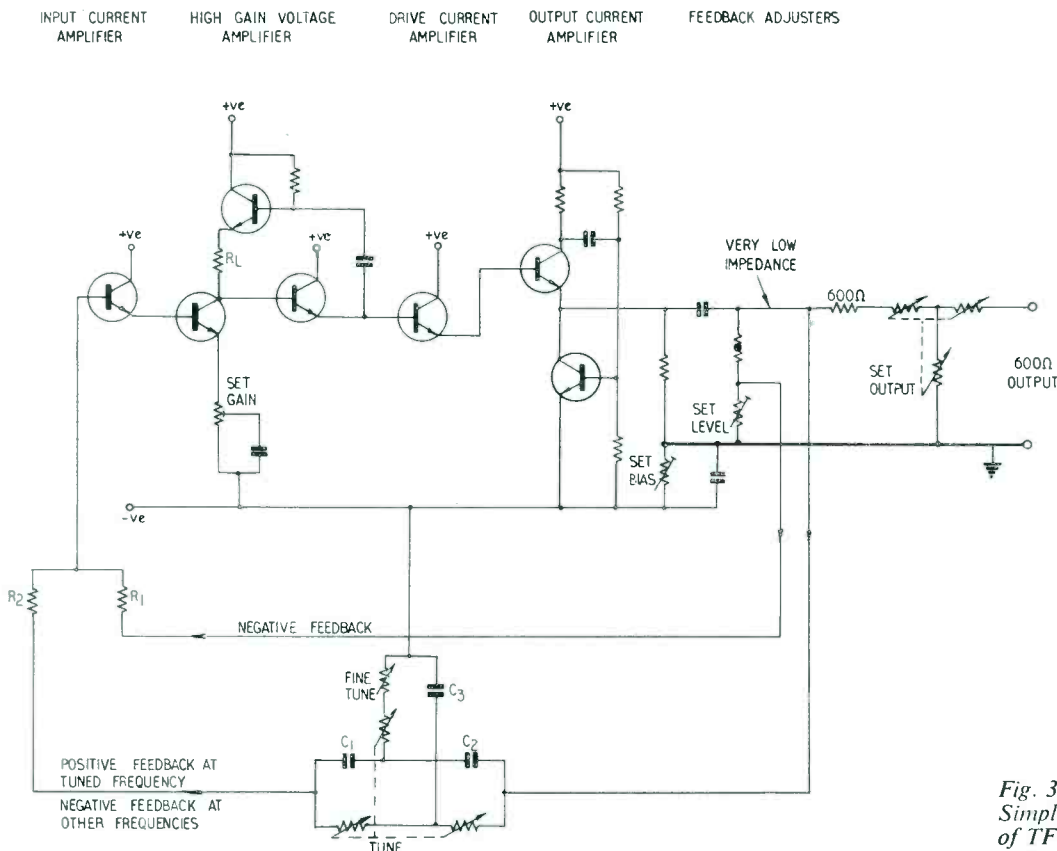

Fig. 3.
Simplified circuit diagram
of TF 2100

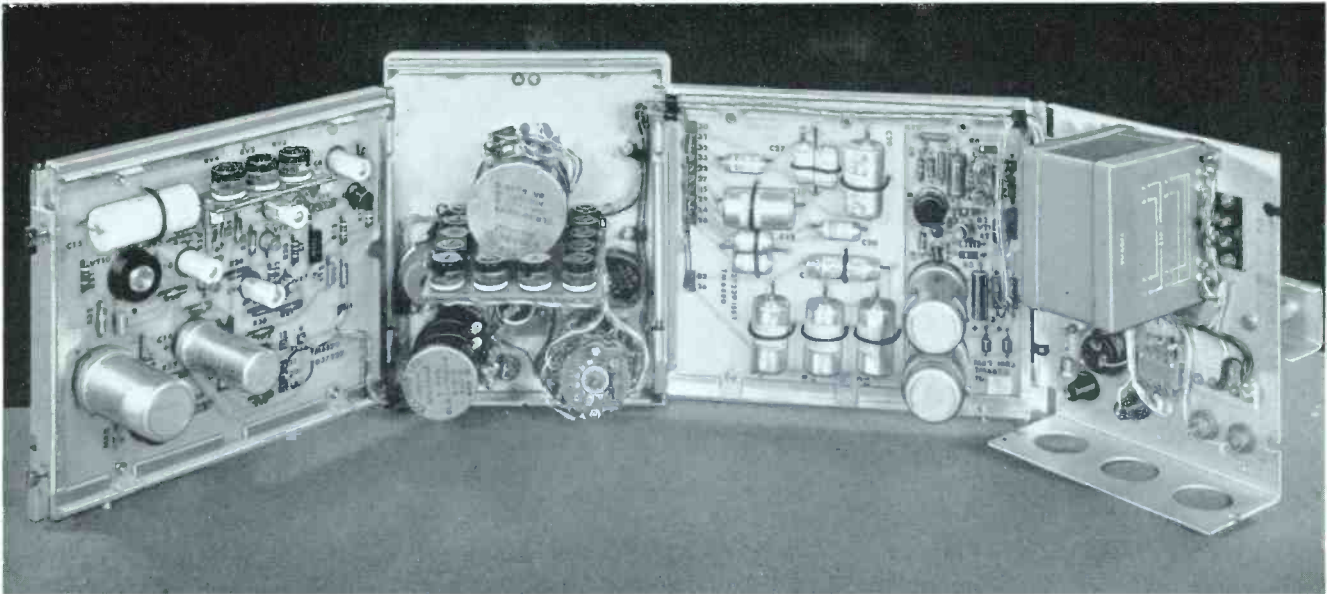

Fig. 4. Instruments in the modular range are hinged to open flat without disconnecting circuits or interrupting the output. This ensures maximum component access during servicing despite the high component density

a loss of performance. The oscillator will operate at a frequency near to the correct one, such that the real component of the net input signal to the differential amplifier has the value and phase angle required, whilst the modulus of the signal is larger and at some considerable phase angle. This situation fails to make use of any gain in the amplifier exceeding the reciprocal of the transmission loss, through the complete bridge, of the real component of the signal. The theoretical situation required is the reverse, i.e. that the gain should be smaller than the reciprocal of the loss, so that any variations in the loss, such as may be occasioned by tuning the network over a range of frequencies, will not vary the distortion in the signal. Now, this is impossible to achieve in a commercial instrument with reasonably priced components, using bridges of the general types described. For instance, a Wien bridge requires a transmission loss as great as 50 dB if it is to reduce the inherent distortion of the amplifier by a factor of 30 dB, such as might be sought for the purpose of obtaining a signal with 0.03% distortion from an amplifier with 1% distortion. The required matching of bridge components is closely similar to the required transmission loss measured in percent; and the maintenance of a match of 0.3% over various ranges and between ranges, especially with the variable resistance tuning which transistors demand, is an uneconomic requirement. Also, there would be anxiety, as already mentioned, concerning the stability of the required two-stage amplifier with so much negative feedback.

Parallel-T Network

Parallel-T networks and their use in oscillators are discussed extensively in the literature. They have remained

without much attraction until several authors have recently pointed out various advantages of deliberate 'unbalance' of the normal relationship between the shunt legs of the two T-pads involved. Instead of a null at the tuned frequency, appropriate unbalance can be arranged to produce merely a trough in which the output signal phase, over a narrow range near the tuned frequency, passes through the condition of being in antiphase with respect to the input. In an oscillator circuit, this can be made to produce positive feedback at the tuned frequency to promote oscillation, and also to produce considerable negative feedback at the harmonics to reduce distortion. Bailey³ provides level control by applying to the amplifier in parallel with the output of the network, a small amount of feedback at the fundamental frequency, obtained from the usual level-conscious potentiometer. The parallel feed dispenses with the need for the amplifier to have a differential input arrangement. His single amplifying stage is equipped with a bootstrap circuit to provide the maximum possible gain.

Looking back at the problems of obtaining low distortion, the important points noted were:

- (1) Inherent distortion in amplifier at rated output,
- (2) Amplifier gain (reduced by a differential input),
- (3) Parasitic oscillation promoted by multiple stages of gain,
- (4) Transmission loss of fundamental through the reactive network,
- (5) Transmission of harmonics by reactive network, relative to fundamental,
- (6) Quality of bridge balance, limited by component matching.

It will be seen that the system described above is very helpful with regard to items 2 and 3. The choice of

net-work has little effect on the non-linearity of the transmission characteristics of the amplifier, item 1, which will not be considered further here. However, items 4 and 5 are considerably affected by the use of an unbalanced parallel-T. By using a slight degree of unbalance, the transmission of harmonics relative to the fundamental (item 5) can be made very good at the expense of a heavy loss of the fundamental (item 4). A compromise situation causes items 4 and 5 to be considerably better in this circuit than in a Wien bridge, or in a capacitance bridged-T, which lies between the two. The final item, 6, bridge balance, can be less troublesome when using the unbalanced parallel-T, a factor which is of great importance. Since the network produces a fairly shallow minimum, rather than a null, it is not surprising that imperfections of component matching do not have such a marked effect on the magnitude and phase of the output as they do in balanced networks. This minimum output is balanced in the complete bridge against the control feedback returning via the level-conscious potentiometer, which comprises a thermistor and SET LEVEL adjuster, as seen in Fig. 3. Due to the high gain available, the resultant output is very small, and slightly in favour of the output from the network, providing a little positive feedback at the fundamental. The system is highly sensitive

to the phase angle of this resultant, promoting high stability of frequency, and it is also highly sensitive to the level of the control voltage. Hence, supply variations have a reduced effect on frequency and output level.

In using any reactive network the thermistor will maintain a constant output by readjusting the negative feedback to allow for changes in transmission of positive feedback. Tuning by ganged wire-wound potentiometers will give rapid variations in the output from the reactive network as the sliders traverse the individual turns of wire on the tracks. The thermal time-constant of the thermistor will not allow it to restore the level instantaneously, so that the variations will be impressed on the output signal as a rapid flutter of amplitude whilst the frequency control is being rotated. Since the transmission through the unbalanced parallel-T varies less with component unbalance than does the transmission through balanced networks such as the Wien bridge, this undesirable jitter is considerably reduced. The thermistor in the present oscillator is already chosen to operate as quickly as possible. The speed is limited by consideration of the distortion which will follow any adjustment of the output level during the time of one cycle of the lowest output frequency of 20 c/s.

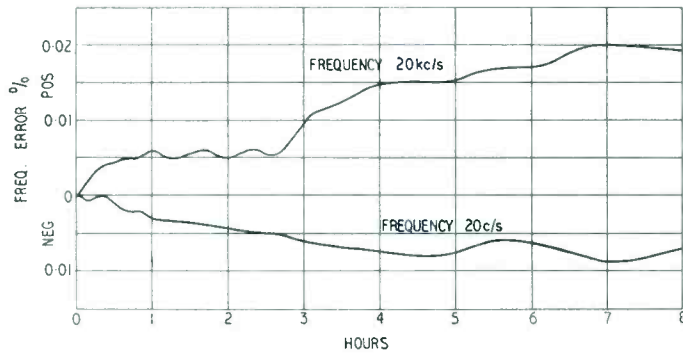
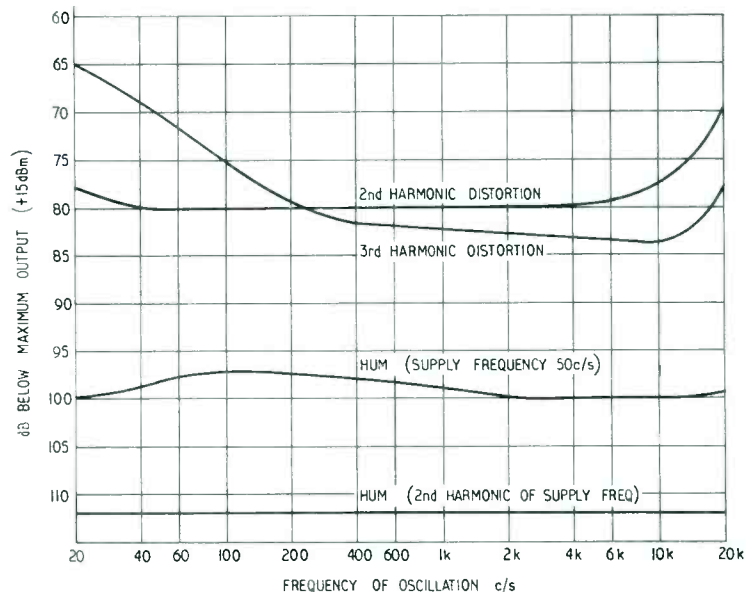

Fig. 5. Typical frequency stability

Fig. 6. Typical harmonic content and supply hum



Returning to the six important items, it will be seen that this system has advantages with regard to each applicable item. However, it has its drawbacks, one of which is the need for three ganged potentiometers instead of two. Another concerns the amount of control feedback which, as shown in Fig. 3, is applied by the thermistor through a resistor R_1 on to the input base; this base being shunted by a second resistor R_2 in series with the output impedance of the parallel-T, so that any variation of the impedance with frequency will tend to alter the feedback fraction, and hence the output voltage.

Basic Circuit

Although the junction R_1/R_2 is a point of low impedance, distortion is improved if the amplifier presents a high impedance to it. Accordingly, the first stage is an input current amplifier providing an input impedance of some 50 k Ω . The voltage amplifier following this has a gain of 50 dB as a result of the two emitter-followers which pass the majority of the collector signal upwards to the top end of the collector load R_L , so rendering its apparent resistance very large. Stability is preserved by arranging that all other stages have a frequency response much wider than that of this stage. This amplifier feeds a current amplifier and thence the output stage, which consists of a pair of transistors arranged as a shunt-compensated emitter-follower, to provide the required current with low distortion at a very low impedance. This impedance is then padded up to 600 Ω , and the signal is passed through a variable 600 Ω T-pad to the output points. The circuit is well isolated from the effects of varying the conditions of output and load: even if the output is short-circuited, distortion only rises a little and the effect

on the frequency is very slight. The normal frequency drift is very small, as shown in Fig. 5. The T-pad is a necessary evil because, if the output stage were fed via a potentiometer, it would be necessary to provide two feedback loops, one each for the oscillator and the output stage, and it would be found more difficult to achieve the required low distortion content.

Fig. 3 shows that the output stage feeds back to the input via two paths, the right-hand path constituting the narrow-band positive feedback via the unbalanced parallel-T network. The left-hand path constitutes the wide-band negative feedback via the level-conscious potentiometer including the thermistor and the SET LEVEL preset control: it will also be found to contain d.c. negative feedback, preset by the SET BIAS control to a different value from the a.c. feedback. The d.c. feedback serves two purposes—it stabilizes the working points of the transistors against changes due to temperature, and also holds the d.c. value of the output point constant so that the relative h.t. across the two output transistors does not shift and cause changes in the amount of distortion. The control is normally set to provide identical h.t. across each transistor: however, with slight off-setting, the instrument can be made to provide temporarily an exceptionally low quantity of second harmonic distortion at any given frequency. A typical record of distortion performance with normal adjustment is shown in Fig. 6.

REFERENCES

1. Hickman, D. E. D. 'Wien Bridge Oscillators.' *Wireless World*. December 1959, 65, p. 550.
2. Sulzer, P. G. 'A Note on a Bridged-T Network.' *Proc. I.R.E.* July 1951, 39, p. 819.
3. Bailey, A. R. 'Low Distortion Sine-Wave Generator.' *Electronic Technology*. February 1960, 37, p. 64.

ABRIDGED SPECIFICATION

Frequency

RANGE: 20 c/s to 20 kc/s, in six bands.
ACCURACY: $\pm 1\%$ ± 0.2 c/s.

CONTROL: At least 40 dB range of
attenuation.

IMPEDANCE: 600 Ω unbalanced.

Distortion

Less than 0.05% from 63 c/s to 6.3 kc/s;
less than 0.1% elsewhere.

Output

POWER: + 15 dBm (31.6 mW) into 600 Ω ;
over 8.5 V open circuit.

Frequency response
 ± 0.4 dB.

Hum

Less than 0.01% (-80 dB) of output sig-
nal, or -100 dBm, whichever is the
greater.

OUR CENTRE PAGE ILLUSTRATION shows all the instruments featured in this issue plus the TF 2700 Universal Bridge described in the last issue. The accessories in the top row are the terminal-to-coaxial adaptors for use with the Oscillators and Attenuators, and the isolating transformer for TF 2700. At bottom left is a rack mounting case fitted with one blank panel. A strong family resemblance is apparent from the standardized instrument sizes, case construction, knobs, drives and dials. The picture also demonstrates the relationship between the composite signal sources in the centre row and the individual instruments directly above them.

M.F. Oscillator TYPE TF 2101

by R. A. TRUAN,
B.Sc.

M.F. Oscillator TF 2101 provides a 600 Ω unbalanced output at frequencies from 30 c/s to 550 kc/s in five overlapping ranges. Output level is continuously variable up to 2 mW with low distortion. Frequency response is within 5%, although over most of the range it is better than 1%. The instrument is transistorized and may be mains or battery operated and has many applications in the field of testing transmission equipment.

A TRANSISTORIZED VERSION of the Wien Bridge oscillator circuit has certain disadvantages. Amongst these, the shunting of the frequency determining components by the low impedance of the amplifier input, and the variation of the transistor characteristics with consequent effect on level, are the most important.

The TF 2101 overcomes these disadvantages by making use of an amplifier whose input is a virtual earth¹ and over which feedback stabilizes the gain. Two such virtual earth amplifiers are employed, see Fig. 1, each consisting of two transistors connected in a common-emitter and emitter-follower configuration. In the first amplifier, impedance Z_1 is connected in series with the input, and Z_2 between output and input provides the negative feedback; this stage has a gain approaching $-Z_2/Z_1$. Similarly, in the second amplifier, R_1 is in series with the input, R_2 provides the negative feedback and the gain approaches $-R_2/R_1$.

By using a series CR combination for the input arm Z_1 and a parallel CR circuit for the negative feedback arm Z_2 , a frequency conscious network is provided. The second stage has a resistor, R_1 , for the input and a thermistor, R_2 , for the feedback arm. Overall feedback is applied by connecting the second stage output to the first stage input; when this first stage gives 180° phase shift the overall feedback becomes positive, and the circuit oscillates at a frequency determined by $f = \frac{1}{2\pi CR}$. The

first stage has a gain of $-\frac{1}{2}$ at this frequency. The amplitude of oscillation is stabilized by TH1, the gain of the second stage regulating itself to -2 , which gives an overall gain of unity. An output control follows the oscillator section and precedes the output stage which provides some gain and an output impedance of 600 Ω.

All the circuits are fed from a -18 V h.t. line derived from the power unit.

Oscillator

Frequency is controlled by means of a wire-wound dual-ganged potentiometer to which the frequency dial is attached. Five ranges are determined by switched capacitors. A second dual-ganged potentiometer of low value in series with the frequency control provides a FINE TUNE control which is particularly useful at the high frequency end of each range. The dial calibration is correct when this FINE TUNE control is set on its centre spot.

It should be noted that if the two reactive arms are not balanced, i.e. do not have equal C's and R's in each arm, oscillations will still occur, but the gain of the first stage will differ from $-\frac{1}{2}$. Thus to maintain oscillations the thermistor has to change its resistance; however, due to the thermal inertia of the device, this cannot occur instantaneously. Therefore any sudden unbalance of the arms will show itself as a sudden change in output amplitude, rapidly returning to normal. Use of close

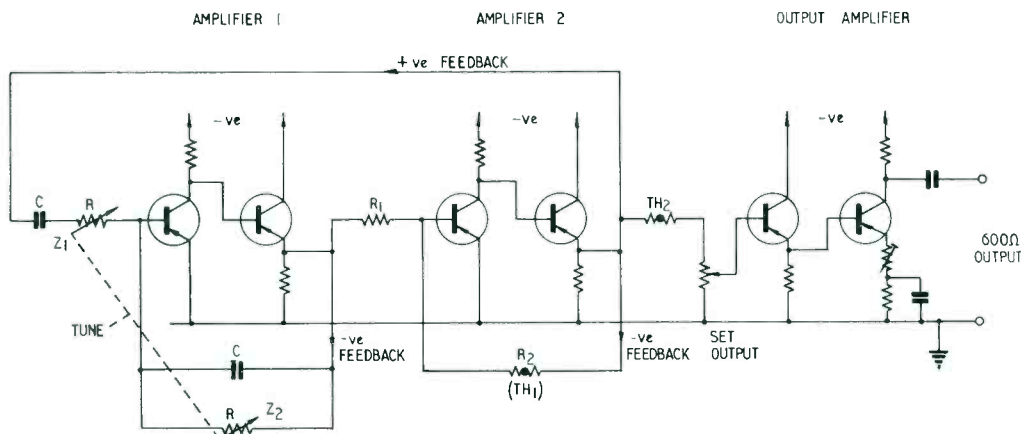

Fig. 1.
Simplified circuit
diagram of TF 2101



Figs. 2 and 3. M.F. Oscillator TF 2101. For fitting in a rack mounting case the cover is easily detached after removing two screws at the rear

tolerance components has minimized this effect when changing range; however, the necessity of using a wire-wound potentiometer introduces a small amount of amplitude modulation due to this cause when the frequency control is used, although the mean output level remains unchanged.

The dial is engraved with three scales, the first three ranges having a common scale and multiplication factors of 1, 10 and 100 respectively. Frequency discrimination of 1% is possible at all points on the dial. An initial calibration accuracy better than 1% may be expected. The frequency-temperature coefficient is of the order 0.02% per °C on all ranges except the highest where it is 0.05% per °C. All other possible causes of frequency shift such as mains voltage, load, or Set Output control variations do not cause errors in excess of 0.2% (0.5% on highest range).

Output Stage

The output from the oscillator section is fed via a second thermistor, TH2, into a potentiometer which forms the Set Output control. TH2 provides compensation for amplitude variation due to the change of oscillator thermistor characteristics with temperature. In this way the output level remains constant over the normal range of temperatures.

An amplifier stage following the Set Output control provides an output impedance of 600 Ω and acts as a buffer between oscillator and external circuitry. A maximum output level of 1.1 V into a 600 Ω load (= 2 mW) or 2.2 V into a high impedance is available. The output stage is isolated from the output terminals by means of a reversible electrolytic capacitor which permits connection to external circuitry at a d.c. potential between -36 V and +12 V. A PANEL-REAR slider switch connects the output either to front panel terminals or to a rear mounted miniature Belling-Lee socket, the latter being of use when the instrument is rack mounted.

Since the TF 2101 is an unmonitored device care has

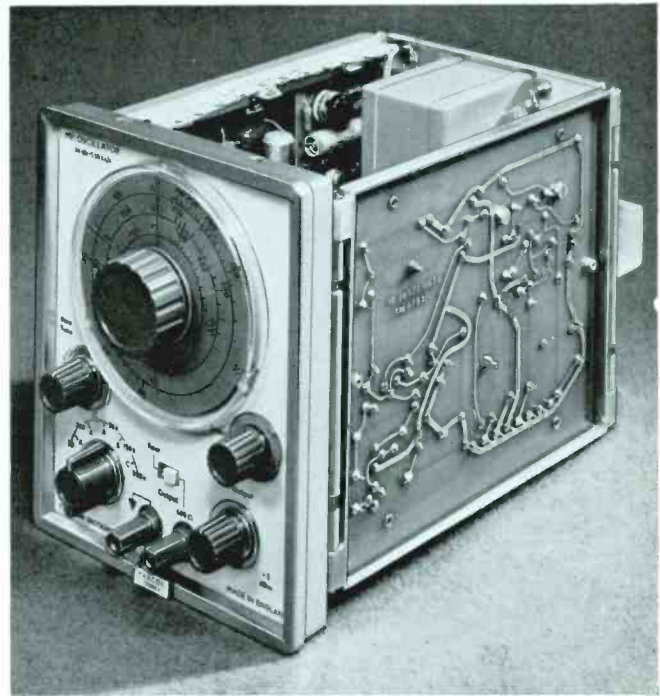

ABRIDGED SPECIFICATION

Frequency

RANGE: 30 c/s to 550 kc/s, in five bands.
ACCURACY: ±3%.

adjustable by continuously variable control.
IMPEDANCE: 600 Ω unbalanced.

Harmonic distortion

Less than 0.5% at 0 dBm.
Less than 0.75% at +3 dBm.

Output

LEVEL: +3 dBm (1.1 V) into 600 Ω;

Frequency response

±0.5 dB.

Hum

Less than -70 dBm with 50 c/s supply mains.
Hum level decreases with output level.

been taken to ensure a good output level frequency response over the range 30 c/s–550 kc/s. Between 50 c/s and 300 kc/s the frequency response is flat to within ± 0.1 dB, but falls approximately 0.3 dB at each extremity of the instrument frequency range. Over the greater part of the frequency range the distortion is less than 0.25% at all operating levels.

Power Supply

A slider switch on the rear panel selects mains or battery operation, and terminals are provided on the rear panel to which external batteries, 21.5 to 30 V, may be con-

nected; a safety diode protects the circuit against batteries inadvertently connected in the reverse polarity. Mains and h.t. fuses are also accessible from the rear panel, the h.t. fuse serving to protect external batteries in the event of a short circuit.

Mains frequency hum in the signal has been kept to a minimum by containing the mains transformer in a mild steel box and screening the mains lead inside the instrument. The hum content operating with 1000 c/s mains is very little worse than the 50 c/s figure.

REFERENCE

1. 'Cathode Ray', 'Virtual Earth'. *Wireless World*, November 1961, 67, p.595.

**MARCONI
INSTRUMENTS**

**NEW
DESIGN**

621.396.662

Three A.F./M.F. Attenuators

by L. W. POOLE,
A.M. Brit. I.R.E.

A.F. and M.F. Monitored Attenuators TF 2160 and TF 2161 have a characteristic impedance of 600 Ω , and both provide 111 dB of attenuation in steps of 10, 1 and 0.1 dB from d.c. to 550 kc/s. The internal voltmeter has ranges of 1.5, 5, 15 and 25 V, and is also scaled in dB with respect to 0 dBm. TF 2160 has additional balanced outputs of 600, 150 and 75 Ω in the frequency range 20 c/s–20 kc/s, and TF 2161 has a 75 Ω unbalanced output at reduced level. M.F. Attenuator TF 2162 has a superior frequency response of d.c.–1 Mc/s and a characteristic impedance of 600 Ω ; it provides the same attenuation range and adjustment, but the output is only available unbalanced and voltmeter facilities are not included. All the above attenuators are capable of handling 1 W.

OVER THE YEARS Marconi Instruments has provided attenuators in many forms to keep pace with the exacting requirements of the electronic industry by providing accurate attenuation over a wide range of frequency and level. As progress continues in the design of all electronic equipment, the attenuator requirements become more stringent and periodically it becomes necessary to bring them up to date. The most recent addition to the range is the light compact modular attenuator which exists in several forms. These are known as the M.F. Attenuator, the A.F. Monitored Attenuator and the M.F. Monitored Attenuator.

The M.F. Attenuator

M.F. Attenuator TF 2162 provides 111 dB of insertion loss adjustable in increments of 0.1 dB available at a single impedance of 600 Ω unbalanced over the frequency range d.c. to 1 Mc/s. Input and output terminals are designed to accept the standard $\frac{3}{4}$ in. spaced double plug. At the maximum frequency or limit of attenuation, it is not advisable to use open wire output connections, and the use of the shielded connector supplied with the instrument is recommended. If these conditions occur simultaneously the connector is essential, as it converts

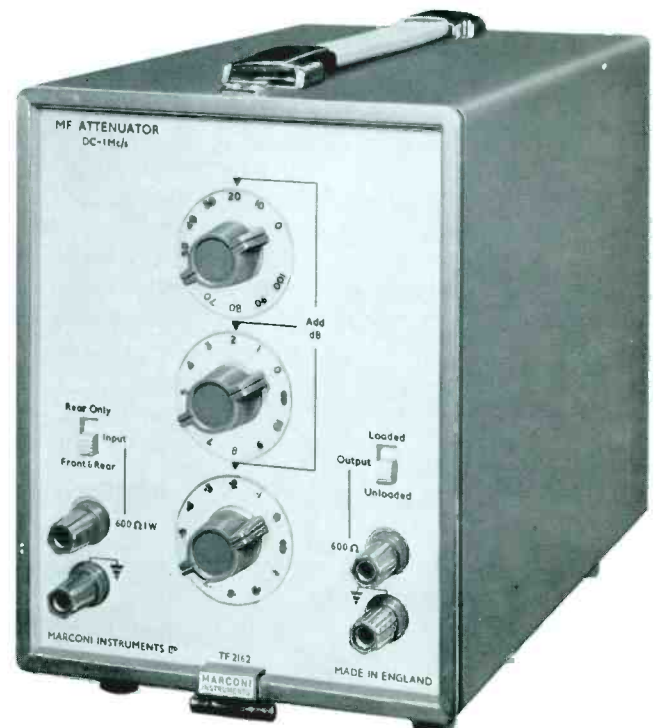

the output system to a BNC socket for use with coaxial leads. The capacitance of such output leads will modify the impedance and level presented to the circuit under test, consequently they must be as short as is practical under the circumstances. An alternative inlet at the rear of the instrument uses a miniature Belling-Lee coaxial socket. Two slide switches are located on the front panel; one enables the input to be selected front and rear or rear only, and the other provides for internal or external load selection.

A.F. and M.F. Monitored Attenuators

A.F. Monitored Attenuator TF 2160 and M.F. Monitored Attenuator TF 2161 provide the same insertion loss and adjustment as TF 2162 with the additional facilities of internal voltmeter and impedance transformation. Each comprises three separate units—step attenuator, as used on TF 2162 but with a frequency range restricted to 550 kc/s due to internal switching, etc., a voltmeter with frequency range 20 c/s to 550 kc/s, and an impedance changer. The attenuator and voltmeter are common to both instruments, but the impedance changer has different characteristics in each model. The voltmeter monitors the attenuator input and the impedance changer modifies the attenuator output. In the TF 2160 the impedance changer is a low distortion matching transformer to provide balanced outputs at 600, 150 and 75 Ω over the frequency range 20 c/s to 20 kc/s. In the TF 2161 it is a switched resistive pad which is matched to 600 Ω and provides an output impedance of 75 Ω unbalanced for applications such as receiver testing.

Both Monitored Attenuators have two parallel inputs—a BNC socket at the front and a Belling-Lee miniature

socket at the rear. The output signal is available from $\frac{3}{4}$ in. spaced terminals, and a switch allows an internal or external load to be selected.

Step Attenuator

The electrical design is based on the use of 1% resistors in conventional 'T' sections chosen in order to preserve the characteristic impedance at low insertion loss. A 1, 2, 3, 4 sequence is used as it gives the minimum number of sections necessary to make up a decade of attenuation. Switched selection of these sections individually or their arrangement in cascade provide the desired insertion loss. Three rotary switches select the required sections, in steps of 10, 1 and 0.1 dB respectively, and also provide zero loss and infinite loss positions.

Inherent in the design of such a switched attenuator is a certain stray capacitance which is variable with setting. This capacitance will modify the input and output impedances and will have greatest effect at high frequency. In the TF 2162 these capacitances were measured for each switch position, giving a maximum value of 125 pF at zero attenuation, decreasing as attenuation is increased up to 40 dB where the input and output capacitances were 115 and 85 pF respectively. Hence, in applications where this is important and changes in attenuation can be accommodated, this attenuator should be used with a minimum of 40 dB inserted loss. The input and output capacitance variations were measured using a specially arranged Schering Bridge as shown in Fig. 1.

These capacitances are modified when the step attenuator is used on TF 2160 and TF 2161 by the addition of lead capacitance.



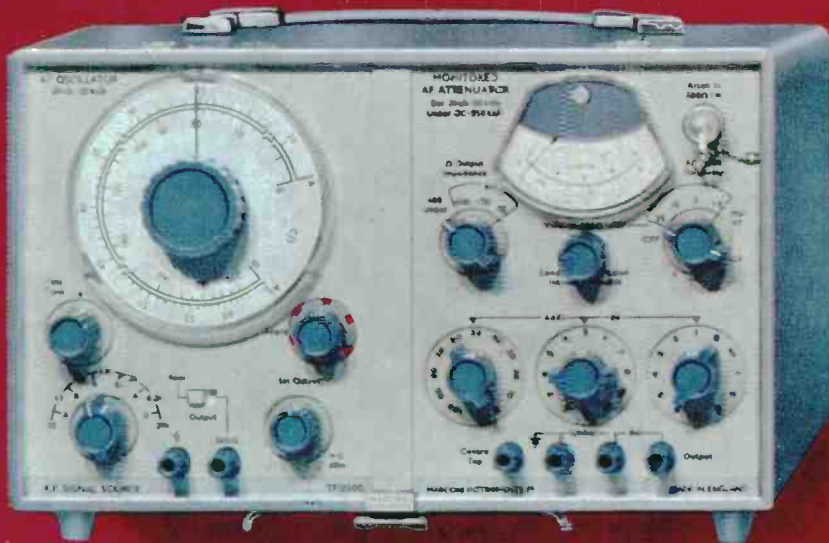

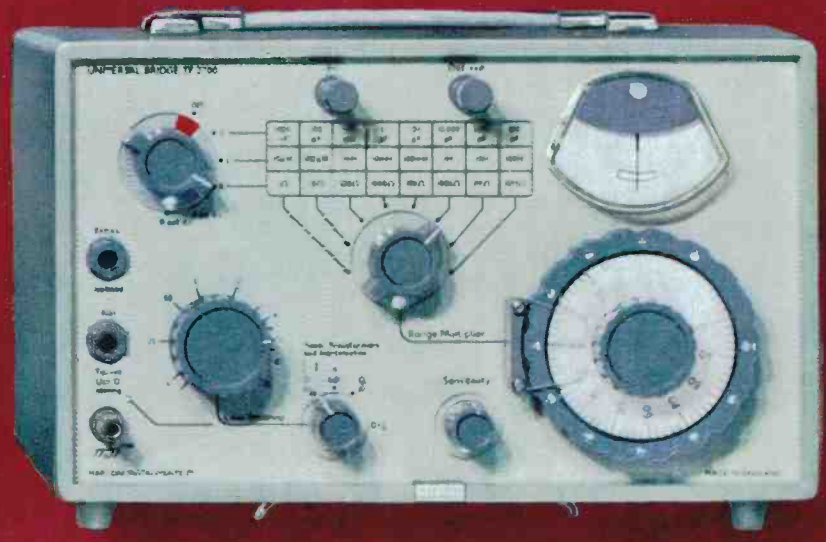
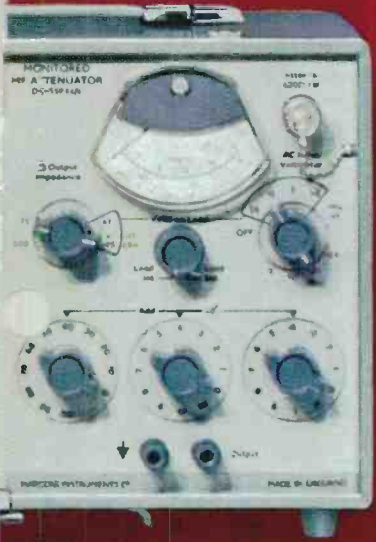
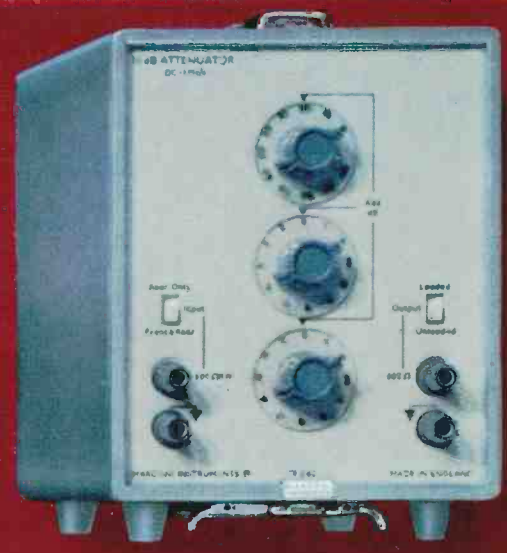
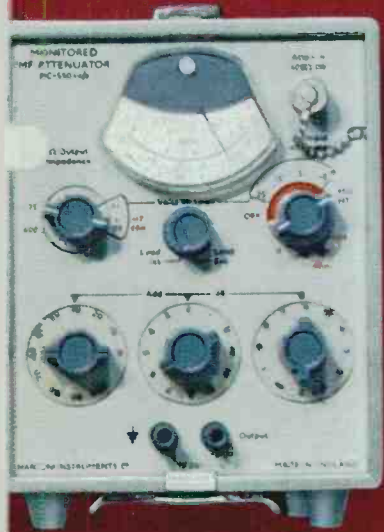

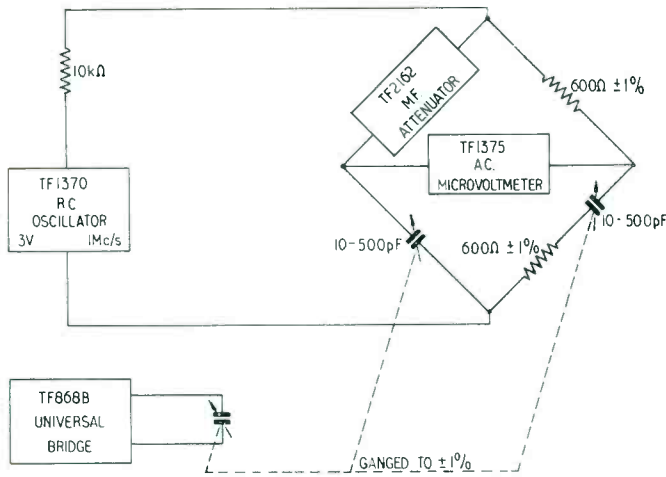

Fig. 1. Schering Bridge to measure attenuator capacitance

Voltmeter

The voltmeter design had to satisfy two major conditions: firstly, it could not be allowed to increase the distortion products from the associated Oscillator; secondly, it had to possess a high input impedance suitable to monitor 600 Ω circuits. The frequency range required was 20 c/s to 550 kc/s, and inputs of up to 25 V r.m.s. had to be accommodated. Examination of the requirements ruled out the use of only a simple rectifier circuit on grounds of impedance and linearity alone; consequently a powered monitor had to be provided. Mobile applications dictated the use of batteries and, in order to conserve the supply, the use of an amplifier-type voltmeter was rejected. Two emitter-follower circuits in cascade were chosen to pre-

cede the diode rectifier as this represents the minimum circuitry necessary to meet the design requirements.

The final design minimizes diode variations and incorporates a voltage doubling rectifier circuit. This provides an acceptable linearity and the complete circuit has a negligible effect on the input signal. A nominal input impedance of 30 kΩ is maintained over the voltage and frequency range and the effect of this impedance can be removed by switching the voltmeter to the OFF position. Provision is made for operation from adjacent equipment, or from two internal mercury batteries when in use alone. These batteries provide 1,000 hours of continuous operation and a CHECK H.T. position is included in the front panel controls.

The voltmeter measures the attenuator input in four ranges; 25 V, 15 V, 5 V and 1.5 V full-scale over the frequency range 20 c/s to 550 kc/s. A typical frequency response is shown in Fig. 2. The meter is scaled in voltage and in decibels with respect to 0 dBm.

Impedance Changer for TF 2160

Owing to the limited appeal of an unbalanced output system at audio frequencies, it was decided to include balanced outputs at the various impedances in common use. This could not be achieved by active circuits as supplies are not available, so the use of a transformer is essential. This transformer, which follows the attenuator, has to satisfy two major requirements: low distortion and low insertion loss. The frequency range required is 20 c/s to 20 kc/s and a level of +15 dBm has to be accommodated.

The choice of nickel-iron laminations was fairly obvious. Consideration of the accepted design procedure

Fig. 2. Voltmeter frequency response

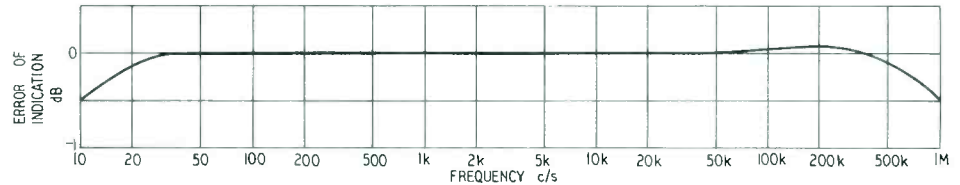
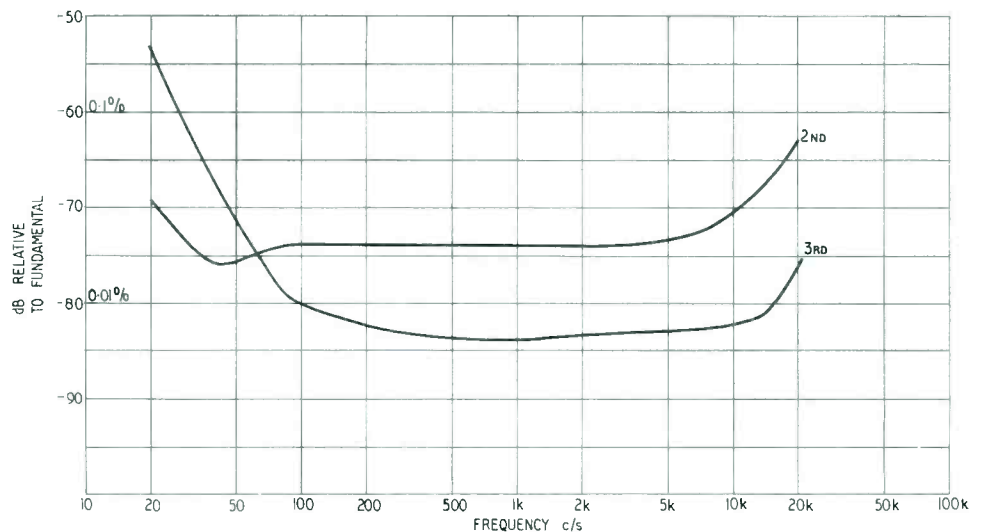

Fig. 3. Harmonic distortion when driven by Oscillator TF 2100



for such transformers showed that the distortion products could be reduced by increasing the quantity of iron and by a suitable choice of alloy assuming fixed induction level. This led to the inevitable compromise between weight and space on the one hand and performance on the other.

From this design approach results a transformer that can provide a distortion factor of better than 0.1% from 50 c/s to 20 kc/s and 0.3% at 20 c/s, when delivering

+15 dBm to the load. It can be used at the maximum rating of the attenuator which is +30 dBm or 25 V; in this condition the distortion factor is better than 3% at 20 c/s and 0.5% at 40 c/s. Fig. 3 shows the expected second and third harmonic components of the output signal when the transformer is fed by Oscillator TF 2100 and delivering +15 dBm. The insertion loss has been reduced to a figure not exceeding 0.3 dB above 50 c/s for the 600 Ω balanced output condition, and a typical variation of this loss is shown in Fig. 4.

Fig. 4. Transformer insertion loss. For greater than 10 dB of attenuation in use and matched external loads

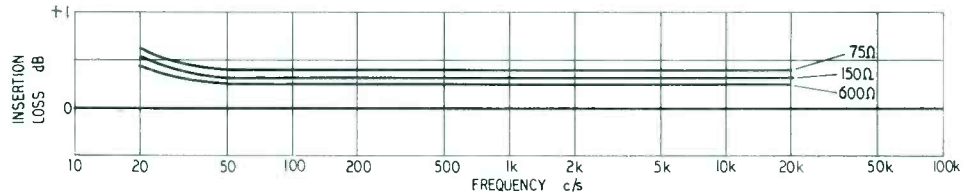

Fig. 5. Transformer output impedance. Internal load in use. The percentage increase in impedance above nominal is shown at 1 kc/s on each curve

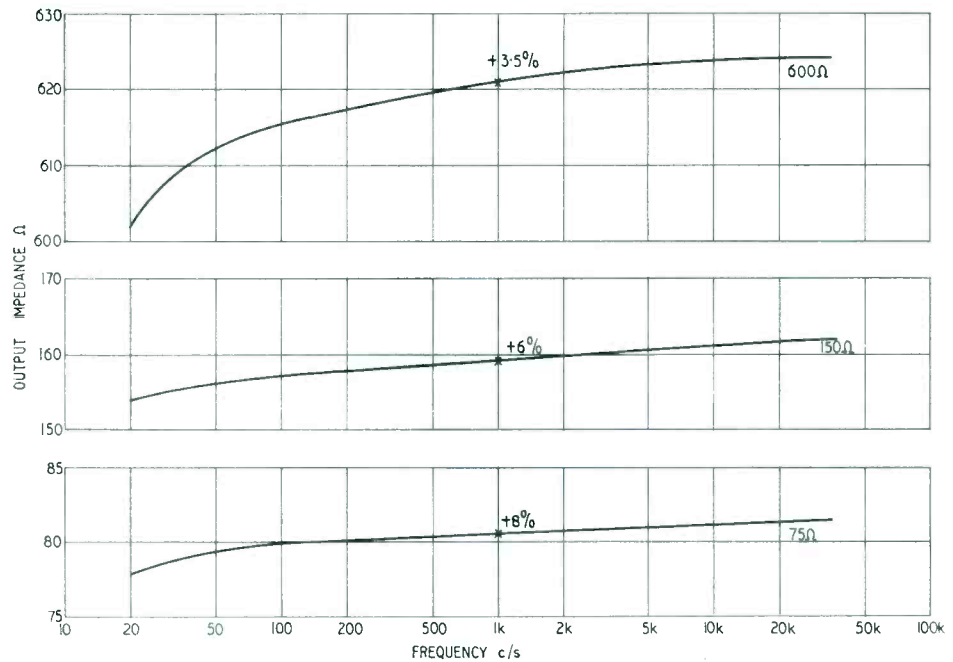
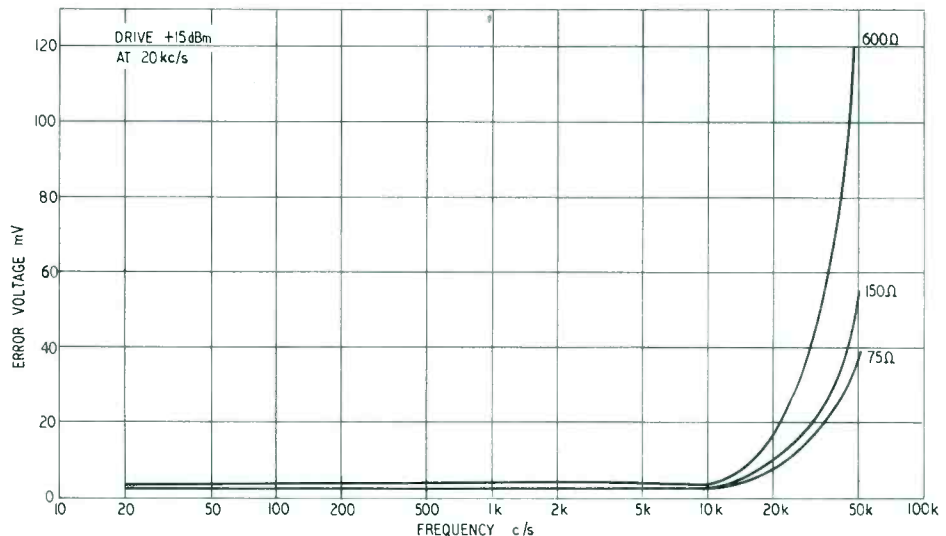

Fig. 6. Balance accuracy



The most widely used balanced impedances appear to be 600, 150 and 75 Ω . These are provided by a single tapped secondary wound to an accuracy of better than 1%, and for the size already decided the secondary resistance is significant on 75 Ω , less so on 150 Ω , and small on 600 Ω . This, unfortunately, modifies the output impedance and could be taken into account by alteration to the tapping point, but this would then provide an incorrect voltage ratio, and within reasonable limits it is better to retain the voltage accuracy and forego the impedance. The internal load is provided by a single 600 Ω resistor across the whole secondary. Variation of output impedance with frequency, when driven by a true 600 Ω source, is shown in Fig. 5. The insertion loss with more than 10 dB of attenuation in use for 150 and 75 Ω is also shown in Fig. 4. The output level is further reduced by the voltage reduction factors of 2 and $\sqrt{8}$ respectively. A capacitor is included in the primary circuit to prevent any d.c. flowing through the winding as this could, if large enough, have a permanent detrimental effect on the quality of the transformer laminations.

Balance accuracy is closely maintained as shown in Fig. 6. As the voltmeter monitors the input to the attenuator then the unbalanced output, assuming 0 dB insertion loss, is the same as that indicated. If the output is now switched to balanced, the terminal voltage falls by the insertion loss of the transformer for the same voltmeter indication.

Impedance Changer for TF 2161

This is not a transformer, but a resistive pad matched to a 600 Ω input. It is basically intended to provide a 75 Ω output, and its loss is an incidental necessity. The minimum voltage loss for such impedance changing pads is $\times 0.707$, which in this case has been rounded off to $\times 0.5$. The power loss is 17 dB and, since the front panel engraving already indicates the input level relative to 0 dBm, this output power loss is also shown.

In conclusion, these attenuators, although restricted to 1 W, have a superior frequency response and impedance accuracy to that of the current TF 338 series, and will in future form the attenuative part of other instruments.

ABRIDGED SPECIFICATION

	TF 2160	TF 2161	TF 2162
Frequency range:	20 c/s-20 kc/s balanced D.C.-550 kc/s unbalanced	D.C.-550 kc/s	D.C.-1 Mc/s
Attenuation:	0-111 dB in 0.1 dB steps	0-111 dB in 0.1 dB steps	0-111 dB in 0.1 dB steps
Input impedance:	600 Ω unbalanced	600 Ω unbalanced	600 Ω unbalanced
Output impedance:	600 Ω unbalanced 600, 150 and 75 Ω balanced	600 and 75 Ω unbalanced	600 Ω unbalanced
Power input:	1 W (25 V) maximum	1 W (25 V) maximum	1 W (25 V) maximum
Voltmeter ranges:	1.5, 5, 15 and 25 V full-scale	1.5, 5, 15 and 25 V full-scale	
Voltmeter frequency response:	20 c/s-550 kc/s	20 c/s-550 kc/s	

DID YOU KNOW that a counter can be used for phase measurement or that a Q-meter can be used to measure frequency? There are, however, a great many unusual applications that we are not aware of; the editors would be pleased to receive reports, with drawings where necessary, of such applications. Those considered of interest to other readers will be published in *Marconi Instrumentation*.

A **NEAT BINDER** to contain copies of Volumes 8 and 9 of *Marconi Instrumentation* has now been made available so that readers and librarians may keep copies of the bulletin in a convenient form for reference. It is bound in red rexine and copies can be inserted without punching and opened flat. These binders are available at a cost of 12s. each, post free. To simplify the transaction please send remittances when ordering.

MARCONI
 INSTRUMENTS

 NEW
 DESIGN

A.F. and M.F. Signal Sources . TF 2000 AND TF 2001

by L. M. SARGENT

A.F. Signal Source TF 2000 provides a maximum level of +15 dBm from 20 c/s to 20 kc/s in balanced or unbalanced loads of 75, 150 or 600 Ω , with distortion over the major part of the range not exceeding 0.1%, or 0.05% in 600 Ω unbalanced loads. An attenuation range of 111 dB is provided, in steps of 0.1 dB, and the attenuator and voltmeter will accept external signals up to 25 V (1 W). M.F. Signal Source TF 2001 has an identical attenuator and meter, and provides a maximum level of +3 dBm from 30 c/s to 550 kc/s in 600 Ω unbalanced loads, or a reduced signal in 75 Ω loads, with distortion not exceeding 0.5% at 0 dBm.

Fig. 1.
 A.F. Signal Source,
 TF 2000, consists of A.F.
 Oscillator, TF 2100, and
 A.F. Monitored Attenuator,
 TF 2160, integrated with
 rear interconnection in a
 single case

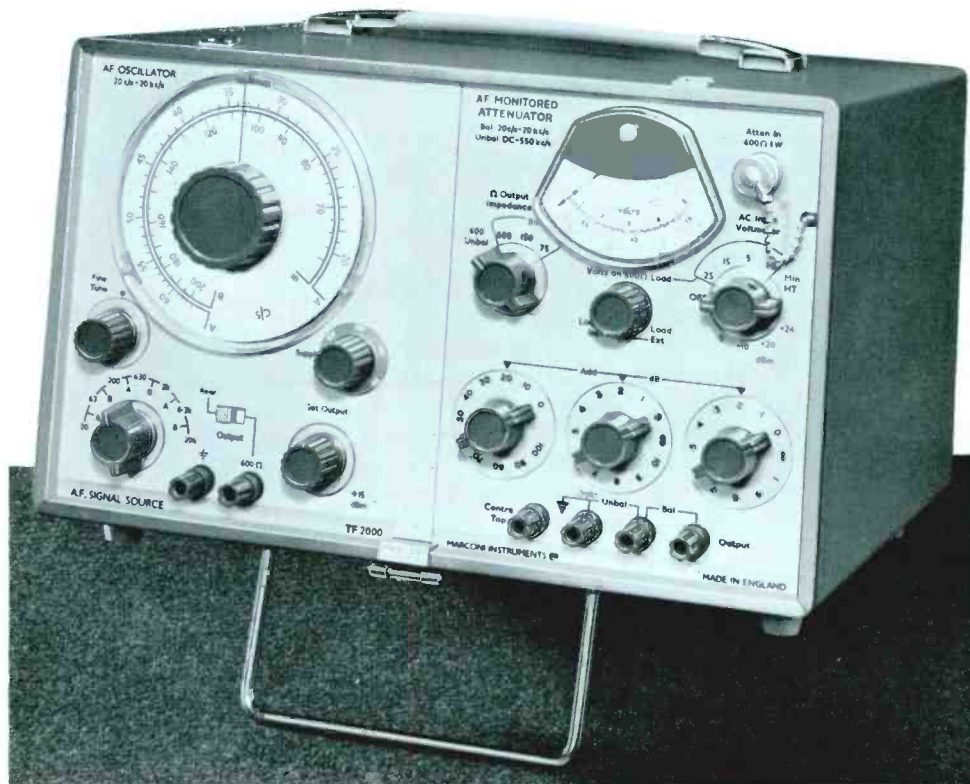

THE PRIMARY PURPOSE of the A.F. Signal Source TF 2000 is the provision of a signal suitable for routine checks on high-fidelity audio transmission apparatus, and particularly for use as a source in tests on distortion, frequency response, operating levels, and gain. The M.F. Signal Source TF 2001 can be used for similar purposes where very low distortion is not necessary, and is useful with other types of transmission apparatus covering the wider bandwidth. The A.F. Signal Source comprises the functioning parts of A.F. Oscillator TF 2100 and A.F. Monitored Attenuator TF 2160, whilst in the M.F. Signal Source are M.F. Oscillator TF 2101 and M.F.

Monitored Attenuator TF 2161. These oscillators and attenuators are the subjects of other articles in this issue. The two instruments contained in a Signal Source are mechanically integrated into a single case, the rear signal interconnection being switch-controlled so as to retain optional direct access to the oscillator output or attenuator input, and the rear power interconnection dispensing with the battery for the voltmeter.

There are good reasons for building up the Signal Sources in this way using modules of identical size. Offering these separately or combined provides a greater range to choose from, and at the same time keener

prices. Furthermore, there is the simplification of maintenance, which is becoming more of a problem as instruments become smaller and smaller.

The title of 'Signal Source' demands a word of explanation. These instruments are closely akin to signal generators, but they lack modulation facilities, and are not lavishly equipped with screening and filtering devices to avoid pick-up by highly sensitive receivers. Lack of these facilities does not entirely prevent them from being called signal generators, but since by common practice the term is generally reserved for those instruments which possess them, the present title was adopted.

Operational Facilities

The left section of each Signal Source consists of the appropriate Oscillator giving a performance as described in the previous articles. Oscillator output is normally switched to appear at the rear socket, where it is coupled to the rear of the Monitored Attenuator. This permanent connection does not lose the facility of being able to switch the two units to a condition whereby they can be used independently of each other; that is, the Oscillator output can still be switched to appear at the front panel terminals only. This also isolates the Monitored Attenuator allowing an external signal to be fed into the input socket.

When used as a Signal Source the voltmeter will monitor the Oscillator level, which is set with the oscillator SET OUTPUT control. The final signal output is accurately set by the step attenuator at any of the output impedances available from the particular attenuator in use. In the case of the A.F. Signal Source these are chosen for use with the audio equipment at radio and television stations and quad transmission cables, in addition to the normal 600 Ω unbalanced output.

Some Secondary Uses

There are one or two other facilities which are worth noting, resulting from the presence of an external input point, and these may prove useful on occasions.

(a) If the attenuation is set to 0 dB, the monitor can measure signals applied at the 600 Ω UNBALANCED outlet, from about 0.1 V on the 1.5 V scale, up to 25 V. Such measurements are restricted to low impedance circuits, the input resistance being 30 k Ω . If the 600 Ω load is switched in, the meter will operate as a level meter, reading power levels in 600 Ω from -6 to +30 dBm. Without the load, the meter will make a bridging measurement instead of matching, when its insertion loss will be less than 0.5 dB. The meter in TF 2000 will also read the same power range in 600, 150 or 75 Ω balanced or unbalanced circuits, if the transformer is switched in.

(b) With the attenuation at 0 dB and the meter switched off, the transformer in the A.F. Signal Source TF 2000 is available alone. It then has its uses as a

balance-to-unbalance transformer in low impedance circuits over the frequency range of 20 c/s to 20 kc/s, or up to some 50 kc/s if a little more loss can be tolerated. It will transform a 600, 150 or 75 Ω source at the BALANCED terminals to a value of 600 Ω unbalanced at the ATTENUATOR INPUT socket, the voltage step-up ratios being 1 : 1, 1 : 2 or 1 : $\sqrt{8}$. This is convenient for providing a balanced input to a wave analyser or distortion

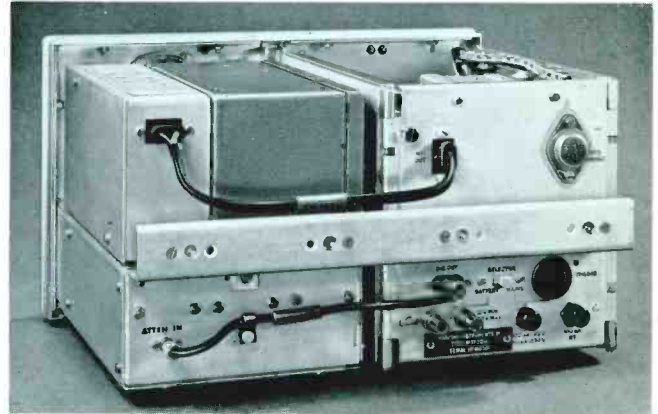

Fig. 2. Rear interior view of Signal Source

factor meter. If inferior frequency response and distortion are acceptable, it can be used in circuits with impedances up to some 10 k Ω . Direct current must not be allowed to flow in the secondary winding, which is connected to the balanced output terminals. The primary winding is protected by a capacitor at the input socket.

(c) The same transformer in TF 2000 has been shown to provide impedance and voltage step-up ratios of 1 : 8 and 1 : $\sqrt{8}$ respectively, when switched to 75 Ω . Consider the oscillator output switched to its panel terminals, and the impedance switch set to 75 Ω . Then, if the oscillator terminals are linked across to the BALANCED OUTPUT terminals, an output will appear at the ATTENUATOR INPUT socket; and this signal will have an approximate impedance of 4,800 Ω , with a maximum off-load voltage of some 20 V over most of the frequency range. This signal can be very useful where higher voltages are needed, and the high impedance and a little extra distortion are not important. This applies particularly to the external modulation of many signal generators.

(d) With the TF 2000 in use in the normal way, using one of the balanced output impedances, an output can be taken from one balanced terminal and the centre tap terminal. Such an output will have half the normal voltage, and nominally one quarter of the normal impedance. So, on switching to 600, 150 or 75 Ω , the voltages relative to normal connections at 600 Ω will need to be multiplied by 0.5, 0.25 or 0.177, and the nominal output impedance will be 150, 37.5 or 18.75 Ω .

Fig. 3.
TF 2001 is the M.F.
counterpart of the TF 2000
shown in Fig. 1



ABRIDGED SPECIFICATION

	TF 2000	TF 2001
Frequency		
RANGE:	20 c/s to 20 kc/s in six bands.	30 c/s to 550 kc/s, in five bands.
ACCURACY:	$\pm 1\% \pm 0.2$ c/s.	$\pm 3\%$.
Oscillator power	+15 dBm (31.6 mW) to attenuator; over 8.5 V open circuit (600 Ω source impedance). At least 40 dB level control.	+3 dBm (1.1 V) to attenuator, adjustable by continuously variable control.
Attenuator		
RANGE:	0 to 111 dB in 0.1 dB steps.	0 to 111 dB in 0.1 dB steps.
ACCURACY:	$\pm 1\%$ of dB setting ± 0.2 dB.	$\pm 2\%$ of dB setting ± 0.2 dB.
OUTPUT IMPEDANCE:	600 Ω unbalanced. 600, 150 and 75 Ω balanced.	600 and 75 Ω unbalanced.
INPUT VOLTMETER:	Ranges: 1.5, 5, 15 and 25 V full-scale.	Ranges: 1.5, 5, 15, and 25 V full-scale.
Frequency response	Output is level within ± 0.2 dB, at any attenuator setting, with the indication of the input meter held constant.	Output is level within ± 0.2 dB from 30 c/s to 20 kc/s, and within ± 1 dB from 30 c/s to 550 kc/s, at any attenuator setting, with the indication of the input meter held constant.
Distortion	Unbalanced output: Less than 0.05% from 63 c/s to 6.3 kc/s; less than 0.1% elsewhere. Balanced output: Less than 0.1% from 50 c/s to 20 kc/s; less than 0.3% from 30 c/s to 50 c/s.	Less than 0.5% at 0 dBm. Less than 0.75% at +3 dBm.
Hum	Less than 0.01% (-80 dB) of output signal, or -90 dBm, whichever is the greater.	Less than -70 dBm. Hum level decreases with output level.

Impedance Measurements and the In Situ Component Bridge

TYPE TF 2701

by E. C. CRAWFORD,
Graduate I.E.E.

Problems associated with the measurement of apparently simple components, particularly electrolytic capacitors, are first discussed and the advantages of having available two frequencies for measurements are pointed out. Examples are then given of in situ measurement so that the advantages of a special in situ bridge are apparent. In conclusion the features of TF 2701 allied to the previous discussion are described.

COMPONENTS used in electrical apparatus are often more complicated in their electrical structure than is immediately apparent. One becomes accustomed to designing electronic amplifiers and so on by first drawing a circuit diagram with each component clearly represented by its own symbol. In non-critical applications the physical realization of these symbols by off-the-shelf components is satisfactory and confidence in the academic knowledge gained at college seems to be supported by the evidence of success.

A time will probably come, however, when everything does not go quite right. The design or specification is such that any component just will not do. The capacitor does not appear to behave as a capacitor should, the resistor no longer appears to follow Ohm's law at higher frequencies, and the inductor labelled 5 henries seems to have peculiar properties not included in its catalogued description.

The reason for the disagreement is that very few ordinary components are pure in the sense that they comprise only one of three constituents of impedance, C, L and R. The resistor inevitably possesses capacitance from terminal to terminal and it will also have capacitance internally between its various elements. In a wire-wound type the inductance may be very obvious, but even axially ground metal film or carbon resistors may possess sufficient inductance to make their use difficult at u.h.f. We are not particularly concerned with r.f. in this article, but nevertheless the effects peculiar at r.f. with resistors of a few hundred ohms are present to some degree at a.f. with resistors of approximately 1 M Ω and more.

Capacitors, except those with a dry air dielectric, will have some dielectric loss which causes an apparent change of capacitance with frequency and a tendency for the phase angle of the impedance to become smaller as the frequency is increased. The current through the ideal capacitor will always be 90° in advance of a sinusoidal voltage across its terminals, but the resistance loss of the dielectric in the ordinary component type will result in a phase angle always less than 90°.

Let us suppose that a capacitor of 1 μ F has at 1 kc/s a Q of 100, and that this low Q is due to the series resistance loss of the dielectric. At 1 kc/s the reactance, X, is 159.2 Ω and the series loss, R_s, equivalent to a Q of 100, is



Fig. 1. Equivalent circuit of typical 1 μ F capacitor

1.592 Ω . If R_s is considered constant with frequency (although it is never completely so), then at a frequency of 100 kc/s the reactance, X, is 1.592 Ω , the same magnitude as the resistance, R_s. The phase angle of the capacitor current will have dropped from almost 90° to 45° and the Q from 100 to 1. The capacitor is half way to becoming purely resistive!

That is a simple example, typical perhaps of many common solid dielectric types, but capacitors such as ordinary aluminium oxide electrolytic types may be more complicated. Due to their construction they are more realistically represented as a form of transmission line; see Fig. 2.

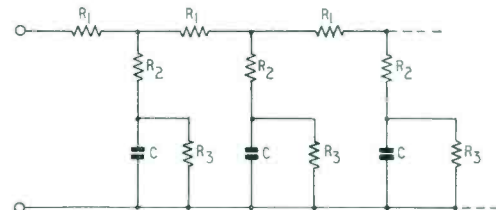
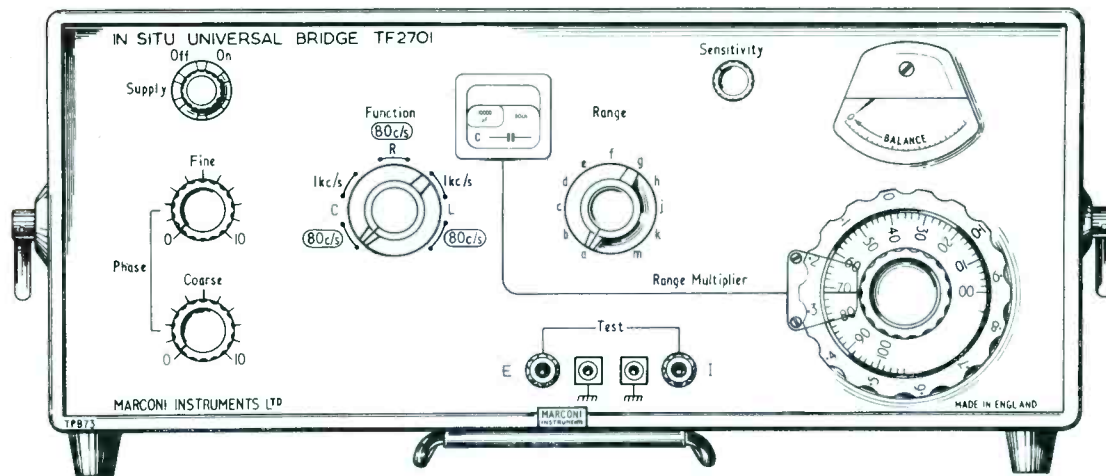

Fig. 2. General representation of an electrolytic capacitor

Unless it is a very poor quality example, R₃ will be very much greater than R₁ and R₂ and will have little influence upon the capacitor characteristics, except that d.c. leakage currents may upset the bias of the associated valve or transistor. Now consider a very high frequency first of all, such that the reactance of the element C approaches zero relative to R₁ or R₂. Then the impedance



In Situ Universal Bridge TF 2701. A colour illustration of the instrument is shown on page 39

of the capacitor will approach R_1 plus R_2 and will be virtually purely resistive. This may be expected to occur at a low radio frequency with electrolytics, with a typical relationship between R_1 , R_2 and C .

At the lowest audio frequencies very little a.c. current flows through each element C and therefore the voltage will be very little attenuated along the 'transmission line'. Hence every element C is almost equally effective, with the result that the total capacitance at the terminals is almost the complete sum of all the 'C' elements and approaches the d.c. value, equal to charge/voltage.

The equivalent series resistance at low a.f. will obviously be different from that at radio frequency and will roughly be equal to all the elements R_2 in parallel considered in series with a proportion of the sum of the elements R_1 in series. The whole capacitor should be thought of as shown in Fig. 3, where R_f and C_f are both

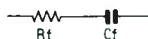

Fig. 3. Electrolytic capacitor at a.f.

frequency conscious. At any frequency the impedance has a magnitude $|Z|$ and a phase angle θ . But such an impedance may also be compounded from parallel elements of R and C . At the very lowest frequencies the reactance is much larger than the series resistance, hence the phase angle of the current approaches 90° , corresponding to a high Q . The parallel C - R combination which has the same impedance and Q must also have the same phase angle of almost 90° . This entails a small resistance current flow corresponding to a relatively high parallel resistance, in fact Q times the reactance.

But at very high frequencies the series impedance deteriorates to approximately $R_1 + R_2$ with a small

capacitive phase angle due to the residual effect of the first element C of Fig. 2; the corresponding parallel equivalent will then also approximate to $R_1 + R_2$ with a similar small phase angle represented however by a very small parallel capacitor, perhaps a tenth of the capacitance measured in the series configuration.

Which of the two representations is correct? The series or parallel? Many impedance bridges will measure a capacitor in either form. Usually the parallel form is designated by C_p or a Q setting, and the series form by C_s and a δ or D setting of the loss balance controls. Many measurements at different frequencies of electrolytic capacitors indicate that the series resistance and capacitance configuration gives an apparent capacitance value, C_s , which is much less frequency conscious than the parallel equivalent, C_p . The latter may be two or three times smaller at 1 kc/s than the value found at 80 c/s. If the actual value at 1 kc/s is that required this may not be important, but a measurement of an electrolytic capacitor at 1 kc/s must always be interpreted with care if the value of capacitance at a much lower frequency is actually required.

A peculiar situation may arise with the measurement of electrolytic capacitors *in situ* with a suitable bridge such as the TF 2701. This type of bridge is arranged so that component values may be measured with the component still connected in its place in the apparatus, a common arrangement of capacitors and resistors in an actual circuit being with the two items in parallel as shown in Fig. 4a. The *in situ* bridge can balance out and thus ignore the parallel resistor when the capacitor is being measured but it cannot distinguish between the resistor and the equivalent parallel resistance of the capacitor itself. If

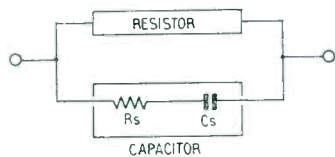

Fig. 4a. Capacitor with shunt resistor



Fig. 4b. In situ measurement without shunt resistor

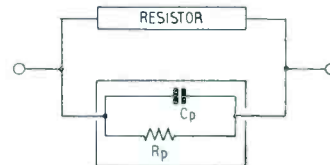

Fig. 4c. In situ measurement with shunt resistor

the circuit in Fig. 4a is considered without the resistor in parallel the capacitor may be measured as shown in Fig. 4b in its series form. With the resistor present the configuration is measured as in Fig. 4c.

Depending upon the capacitor Q and the measurement frequency the value C_p as already explained may be two or three times less than the required value, C_s . It is obviously advantageous to have alternative frequencies available for such applications and TF 2701 has both 80 c/s and 1 kc/s.

Another possible source of confusion can arise when measuring a resistor shunted by a capacitor containing significant loss resistance. It is impossible for the bridge to separate the resistor from the parallel equivalent loss of the capacitor. The resultant answer for the value of the resistor may be quite seriously different from the true value. We have indicated that R_p of the capacitor is frequency conscious and that R_p tends to increase inversely with frequency. Hence more realistic answers for resistor measurements are obtained at 80 c/s than is possible at 1 kc/s or higher frequencies. The question may be reasonably asked: 'Why bother with 1 kc/s at all?' The answer here is that 1 kc/s has advantages for capacitance measurements for all capacitors other than those such as electrolytics which have relatively high loss. At 1 kc/s the reactance of the capacitor is about 12 times less than at 80 c/s and this gives correspondingly increased sensitivity for accurate measurements. The Q of a parallel C and R combination is also about 12 times higher at 1 kc/s than at 80 c/s so that balance adjustments are easier to carry out. The converse when resistance is being measured suggests the use of the lowest possible frequency so that the presence of any form of shunt capacitance is less significant.

The desirability of at least two frequencies in an *in situ* component bridge having been explained, some further aspects of *in situ* measurements will be examined

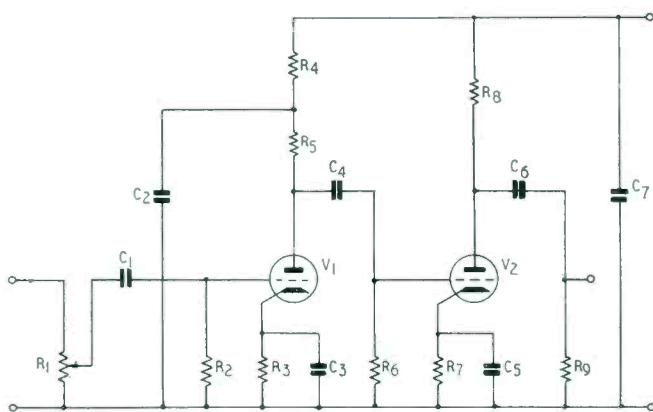

Fig. 5. Typical circuit for in situ measurements

starting with the section of circuit shown in Fig. 5 which may be typical of many.

A close examination will show that every resistor in this diagram may be measured by ordinary d.c. means

because a valve may be considered as an open circuit. But a.c. measurement of the resistance value will not be so simple because the capacitors cannot then be disregarded, nor can all the capacitors be simply measured with accuracy by two terminal methods. C_1 , C_3 and C_5 may perhaps be measured because the parallel resistors can be balanced out by the Q dial on a C_p bridge, the valves being 'open circuit' serving to isolate the capacitors concerned. But C_2 , C_4 , C_6 and C_7 are all interconnected via resistors, and a two-terminal measurement would result in a very approximate answer depending upon the relative magnitude of the nearest resistors and the other

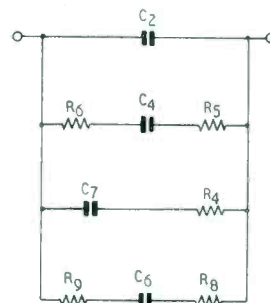

Fig. 6. Two-terminal view of C_2 in Fig. 5

capacitors. For example, an ordinary two-terminal bridge connected to C_2 would 'see' the circuit of Fig. 6 which excludes valves as these may be considered open circuit. The measured result can obviously be very misleading.

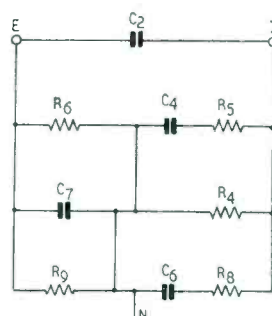

Fig. 7a

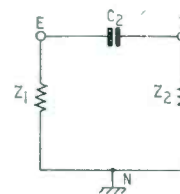

Fig. 7b

Three-terminal view of C_2 in Fig. 5

The great feature of an *in situ* bridge is its ability to carry out three-terminal measurements. This permits all unwanted shunt current paths which possess a suitable tap to be bypassed to earth in such a way that the balance condition of the bridge is unaffected. The three-terminal version of Fig. 6 is shown in Fig. 7a and a simplified equivalent version in Fig. 7b. Z_1 represents R_6 , R_9 and C_7 in parallel and Z_2 represents the combined parallel effect of the remainder. Now provided Z_1 or Z_2 connected from the terminals E or I to N have no effect upon the accuracy it is clear that C_2 may be measured with normal precision. In the ordinary universal bridge (Fig. 8) Z_1 shunts the standard capacitor and must therefore affect the accuracy.

Z_2 shunts the detector and affects the sensitivity but not the accuracy, the detector being at earth potential at balance. *In situ* bridge TF 2701 is quite differently arranged from Fig. 8 as may be seen from the schematic

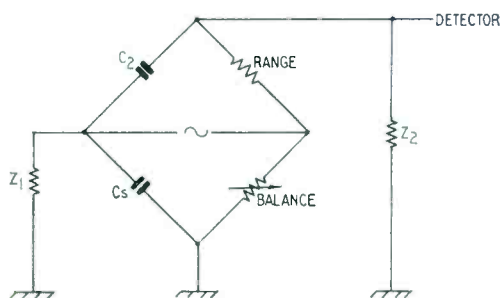

Fig. 8. In an ordinary universal bridge Z_1 shunts C_s

diagram in Fig. 9 which shows the test capacitor C_2 with Z_1 and Z_2 from the fictitious test circuit.

Without going into elaborate formulae it can be seen that, provided the coupling between windings in the transformers is well-nigh perfect, Z_1 merely loads the oscillator and Z_2 the detector. Neither is in any way in parallel with C_2 and the bridge standard, C_s , and therefore they cannot affect the balance conditions. By applying voltages 180° out of phase and of suitably arranged amplitude to C_2 and C_s , the total magnetizing current in the I (for current) transformer is made zero. The balance dials will in this example give the selected voltage ratio in terms of capacitance, range switching being effected by

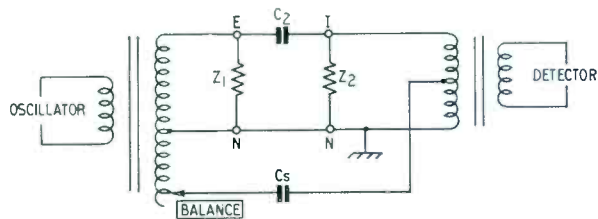

Fig. 9. Basic *in situ* bridge

altering the taps on the transformers in decades. Other types of impedance measurements are carried out by substituting the appropriate impedance for the capacitors C_2 and C_s in Fig. 9. More detailed descriptions of the theory of transformer ratio arm bridges may be found in the references at the end of this article.^{1,2} We are concerned here, however, with the particular merits and features of TF 2701 and details of some of its measurement capabilities.

Low Terminal Power

Referring to Fig. 5, the typical circuit diagram which was used as an example of *in situ* measurement, let us suppose that the valves are replaced by wired-in transistors. All the isolation provided by the 'open circuit' valves has gone, and only R_1 may be measured by normal two-terminal bridges. A three-terminal *in situ* type of bridge

can neutralize the unwanted ' Z_1 's' and ' Z_2 's' of Figs. 7 and 9, but with transistors one has to be careful of accidental burn out. The power output from the TF 2701 oscillator has been limited to about 50 mW to reduce the risk on this account, most transistors having a rating of at least 50 mW.

The effect of a semiconductor junction connected in shunt from the E terminal to neutral is to distort the sine wave into a series of half sine waves. The fundamental component is halved and the harmonic content considerably increased. The detector has good selectivity however, and unless the component on test is extremely frequency conscious there will be little noticeable effect upon the balance. Across the I transformer there is zero voltage at balance and a semiconductor in shunt with this will have even less effect. The low available power also renders the bridge safe to use with the smallest resistors and with tantalum capacitors, of which the low voltage types are particularly accident prone.

Wide Capacitance Range

The largest capacitor is 11,000 μF and the smallest 0.002 pF which can be measured directly from terminal to terminal of this bridge. Special screening precautions have to be taken with very small values, but there is no need to remember alternative methods of connection for different ranges of measurement. All measurements are made by connection between the two terminals. The lowest range is 1.1 pF full scale and .002 pF represents the first calibrated mark above zero; this range is therefore suited to making interelectrode measurements of valves and for testing the efficiency of electrostatic screens. Working up in decades, the eleventh brings in 11,000 μF , so that this bridge has one of the widest direct capacitance ranges available.

For electrolytic measurements as previously considered the use of 80 c/s is recommended for realistic results, but if the capacitor Q warrants the test 1 kc/s may also be used. Certainly for small capacitors 1 kc/s is recommended to enhance the discrimination. Because of the three-terminal nature of the *in situ* bridge it is very simple to measure small capacitors remote from the bridge but connected to it by long screened leads. The screens are joined to neutral and therefore the lead capacitance is only in shunt with the transformer windings and does not affect the measured value of capacitance. The phase balance controls will balance out residual loss of the capacitor and will also balance out a substantial parallel resistance loading if this cannot be neutralized.

Application of D.C. Bias to Capacitors

This may be done in a number of ways, largely dependent upon the capacitor value. When using mains energized bias supplies care should be taken to reduce the mains hum as much as possible by extra smoothing or regulation to avoid interference breaking through the detector selectivity and masking the balance.

In every case, as will be seen, precautions are taken to avoid currents flowing into the transformer windings. These are wound on mumetal, a material which is fairly easily saturated magnetically. Saturation can have a drastic effect upon the ratio of the windings and will give rise to serious measurement errors. A small amount of current does no harm, but it is as well to arrange that none flows and thus prevent accidental errors.

Method 1—suitable for small capacitors up to say 0.1 μF

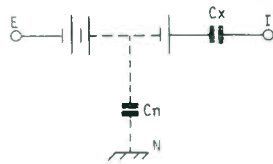

Fig. 10.

The bias supply is connected in series with the capacitor, C_x , as shown in Fig. 10. C_n , the capacitance of the supply to earth, will have negligible effect as it is across a low impedance transformer winding.

Method 2—suitable for the smallest capacitors

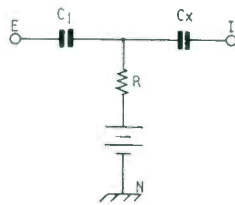

Fig. 11.

The battery is connected via an isolating resistor, R , as shown in Fig. 11. As C_1 , the blocking capacitor, ought to be many times C_x this method is suited, say, to capacitors of less than 10,000 pF.

Method 3—suitable for the largest capacitors

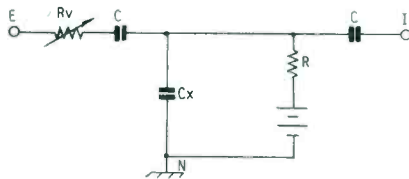

Fig. 12.

The biasing arrangement is shown in Fig. 12. If C_x is between 100 and 10,000 μF, use 1 μF for C , 1 kΩ variable for R_v and 1 kΩ fixed for R .

The loss balance controls on the bridge should be set to highest Q (zero D) and balance carried out with the decade control for C balance and R_v for loss balance.

Without R_v the circuit of Fig. 12 exhibits negative transfer resistance and cannot be balanced out by the bridge. The measured value C_m for the above example will be 100 pF for 10,000 μF and 10,000 pF for 100 μF.

The value of the unknown is evaluated from the formula:

$$C_x = \frac{C^2}{C_m} - 2C \text{ which provided } C_x \gg C, \text{ simplifies to } C_x = C^2/C_m$$

where C_m is the measured value.

The T Attenuator Effect

Method 3 for biasing capacitors illustrated in Fig. 12 is typical of a type of impedance transformation peculiar to three-terminal bridges. In a T attenuator, as in Fig. 13a, it can easily be seen that the open circuit e.m.f. available

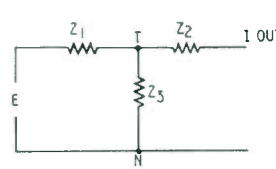

Fig. 13a.
T attenuator

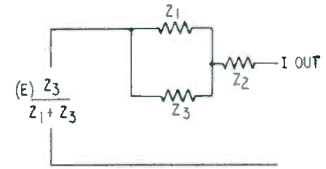

Fig. 13b.
Equivalent of T attenuator

at T is $E Z_3 / (Z_1 + Z_3)$. This e.m.f. has a source resistance of Z_1 and Z_3 in parallel, and can drive current through Z_2 . The circuit then is equivalent to that in Fig. 13b whose effective transfer impedance $Z_t = Z_1 + Z_2 + Z_1 Z_2 / Z_3$.

Substituting 1 MΩ resistors for Z_1 and Z_3 and 1 kΩ for Z_2 the transfer resistance becomes 1002 MΩ, but with the advantage that the frequency characteristic is 1000 times better than that of any practical 1000 MΩ resistor. This method is used in TF 2701 to provide a shunt resistance of high value and low capacitance to compensate for the internal loss of the capacitance standard. Note that a single section π type of attenuator has a transfer impedance only equal to the resistance of the series resistor because the shunt resistors will only load the E and I transformer windings.

Resistance Measurement

The T attenuator effect can inadvertently influence the measurement of very high resistance as the frequency is raised because stray capacitance to earth can have a serious effect upon the measured transfer resistance. The lower the measurement frequency the less the effect is noticeable and it was for this reason that 80 c/s rather than 1 kc/s was chosen for resistance measurement in TF 2701. Problems occasionally arise that require the measurement of insulation resistance of several thousand megohms. If this is carried out at a.c. the probable result will indicate the dielectric loss of the insulation involved which will probably bear little relation to the d.c. insulation resistance.

The resistance range extends from 110 MΩ full scale down to the limit set by the residual resistance, R_o , of the bridge which is approximately 30 mΩ. On the lowest range there is a dial calibration of 2 mΩ per division and

incremental resistance of this order may be measured directly if the leads are checked first.

The resistance calibration is linear and reads directly in ohms. A simpler construction is possible if a reciprocal law is used or calibration is in mhos instead of ohms. The ease of readout of the direct linear ohms calibration justifies, however, the adoption of the more complicated design.

Provision is also made for resistance measurement in the presence of shunt capacitance, a common feature of *in situ* circumstances. But it was not easy to decide how much shunt capacitance should be provided for, as difficulties arise if the amount is too large. The capacitance has always to be balanced out separately and a large capacitance range makes the setting unnecessarily critical. Also the inevitable dielectric loss of the capacitor will affect the measured resistance as the bridge cannot distinguish between the two; this becomes more pronounced as the shunt capacitance is increased.

The final value chosen was 50 μF maximum for the 1000 Ω range full scale. Thus values of resistance between 100 and 1100 Ω may have up to 50 μF in parallel when being measured. On other ranges the resistance and associated reactance are related by the common decade multiplying factor, e.g. 100 k Ω to 1.1 M Ω have a possible parallel C of 0.05 μF . The error to be expected is small if air, mica or polystyrene capacitors are in shunt, but increases with paper and plastic film dielectrics and really becomes large when electrolytic capacitors are involved. This type of error is independent of the bridge design except that the error is usually smaller at low measurement frequencies. This is one more advantage of 80 c/s rather than 1 kc/s or higher for *in situ* resistance measurement.

Inductance Measurement

In TF 2701 a great amount of trouble has been taken to preserve the two-terminal method of connection, which is the same for all inductors regardless of range, and a linear inductance scale. It may not be immediately appreciated that a linear inductance or resistance scale is so superior to one calibrated with a reciprocal law such as a conductance scale would be.

With a reciprocal type of calibration the scale usually starts at 1 (instead of 0) and goes to infinity (instead of say 11). The scale of the basic element is very non-linear; half the scale length is devoted to 1 to 2 and only $\frac{1}{8}$ the length from 4 to 8. A calibration readout uncertainty

of say 0.1% of mechanical full scale is equivalent to 0.1% of reading at 1, becomes 0.5% of reading at 5, and 1% of reading at 10. The linear scale, on the other hand, has better than $\frac{1}{2}$ % of reading error for values greater than 2, i.e. for 80% of all scale values instead of 50%.

The two-terminal connection advantage and the linear scale, together with two-frequency operation, have been achieved by using an inductor as the inductance standard. Using the transformer ratio method of range tapping, the inductor on test is balanced by a simulated identical inductor inside the bridge. This inductor is arranged to vary by varying the source e.m.f. derived from a linearly calibrated resistor chain, the series loss of the inductor on test being balanced out by a variable resistor in series with the standard inductor. These arrangements hold until the Q of the inductor on test is better than that of the standard. This occurs at a Q greater than 10 at 80 c/s and greater than 50 at 1 kc/s. The higher Q inductors are balanced by a parallel arrangement which at low Q would give a serious error, but at Q greater than 10 the error is less than 1% and at Q greater than 50 is less than 1 part in 2500.

With arrangements very similar to those described for capacitors it is possible to pass d.c. through inductors on test, but blocking capacitors of sufficiently low reactance should be placed in series with the inductor so that the d.c. does not flow through the transformers.

Advantage is taken of the low shunt impedance of the transformer arrangement for the d.c. to be supplied from an earthed power supply through comparatively low value, but perhaps high wattage, resistors. The dissipation in the resistors and the limitations of a well smoothed power supply are, in theory anyway, the only factors controlling the amount of current which can be fed through an inductor on test. It has been known, however, for saturated inductors to have an inductance that varies over the cycle of applied a.c. so that it has proved impossible to obtain a reliable balance. On all ranges it has been the policy in the design of TF 2701 to keep the applied a.c. voltage as low as possible consistent with sensitivity. This helps considerably in testing inductors prone to saturation.

REFERENCES

1. Clark, H. A. M. and Vanderlyn, P. B. 'Double-Ratio A.C. Bridges with Inductivity Coupled Ratio Arms.' *Proceedings I.E.E.* May 1949, 96, Part III, p. 189.
2. White, L. G. and Golding, J. F. 'The Transformer-Ratio-Arm Bridge used for the Measurement of Low Capacitance.' *Marconi Instrumentation*. June 1960, 7, p. 168.

ABRIDGED SPECIFICATION

Bridge type

Transformer ratio arm suitable for either two- or three-terminal measurements.

Bridge source and detector

INTERNAL: 80 c/s and 1 kc/s.

Range

CAPACITANCE: 0.002 pF to 11,000 μF in 11 ranges.

RESISTANCE: 10 m Ω to 110 M Ω in 9 ranges.

INDUCTANCE: 1 μH to 110 kH in 10 ranges.

Basic accuracy

CAPACITANCE: $\pm 1\%$.

RESISTANCE: $\pm 1\%$.

INDUCTANCE: $\pm 2\%$.

Power supply

Two 9 V batteries—life about 3 months at 4 hr/day.

Summaries of Articles appearing in this issue

RESUME D'ARTICLES PUBLIES DANS LE PRESENT NUMERO

OSCILLATEUR BF TF 2100

Ce petit oscillateur transistorisé, sur audio-fréquence, a une sortie libre de 8 V au moins, ou une sortie de 4 V sous charge équilibrée de 600 ohms, entre 20 Hz et 20 kHz. Le facteur de distortion ne dépasse pas 0,05% entre 63 Hz et 6,3 kHz et 0,1% sur le reste de la plage. La tension de sortie peut être réglée à volonté du simple au centuple.

Page 28

OSCILLATEUR MF TF 2101

Oscillateur fréquence moyenne donnant une sortie non équilibrée de 600 ohms, sur une plage de fréquence allant de 30 Hz à 550 kHz en cinq échelles se chevauchant. Le niveau de sortie peut varier à l'infini jusqu'à 2 mW avec faible distortion. Caractéristique de fréquence à 5% près, bien qu'inférieure à 1% sur la majeure partie de la plage. L'appareil est transistorisé et peut fonctionner sur batterie ou sur secteur. Il offre une large gamme d'utilisations dans le domaine des essais de matériel de transmission.

Page 34

TROIS ATTENUATEURS BF/FM

Les atténuateurs BF/FM contrôlés, modèles TF 2160 et TF 2161, ont une impédance de 600 ohms et donnent tous deux un affaiblissement de 111 dB par étapes de 10, 1 et 0,1 dB, entre 0 et 550 kHz. Le voltmètre interne est calibré en échelles de 1,5; 5; 15 et 25 V ainsi qu'en décibels portant sur 0 dBm. Le TF 2160 a des sorties équilibrées supplémentaires de 600, 150 et 75 ohms sur fréquences de 20 Hz à 20 kHz et le TF 2161, une sortie non équilibrée de 75 ohms à niveau réduit. L'atténuateur FM, type TF 2162 a une caractéristique de fréquence plus élevée, allant de 0 à 1 MHz, et une impédance type de 600 ohms; il offre le même degré d'affaiblissement et de réglage mais sa sortie n'est pas équilibrée et il ne

possède pas de voltmètre. Ces trois atténuateurs conviennent pour une puissance de 1 watt.

Page 36

SOURCES DE SIGNAUX BF/MF TF 2000 ET TF 2001

L'ensemble-source de signaux BF, type TF 2000, a un niveau maximum de sortie de +15 dBm entre 20 Hz et 20 kHz pour des résistances de charge de 75, 150 et 600 ohms, avec distortion ne dépassant pas 0,1% sur la majeure partie de la gamme ou 0,05% pour charges de 600 ohms. Il offre un affaiblissement de 111 dB par étapes de 0,1 dB; atténuateur et voltmètre acceptant des signaux extérieurs allant jusqu'à 25 V (1 watt).

L'ensemble-source de signaux MF, modèle TF 2001, possède le même atténuateur et le même voltmètre et donne un niveau maximum de sortie de +3 dBm entre 30 Hz et 550 kHz, dans une résistance non équilibrée de 600 ohms, ou bien un signal réduit dans des résistances de 76 ohms, avec niveau de distortion ne dépassant pas 0,5% à 0 dBm.

Page 43

LA MESURE DES IMPEDANCES ET LE PONT POUR MESURES 'IN-SITU' TF 2701

La discussion porte en premier lieu sur les problèmes soulevés par les mesures sur les composants d'apparence assez simple tels que les condensateurs électrolytiques et souligne les avantages du principe des deux tensions.

On donne ensuite des exemples de mesures en place qui mettent en évidence les avantages d'un pont spécialement adapté à cet usage. Vient ensuite une brève description des caractéristiques du pont TF 2701 dans le cadre de la discussion des problèmes précédemment exposés.

Page 46

ZUSAMMENFASSUNG DER IN DIESER NUMMER ERSCHEINENDEN BEITRAGE

TONFREQUENZ-OSZILLATOR TF 2100

Dieser kleine transistorisierte Tonfrequenzoszillator liefert mehr als 8 V Leerlaufspannung oder 4 V an einen angepassten 600 Ohm Abschluss über einen Frequenzbereich von 20 Hz bis 20 kHz. Im Frequenzbereich von 63 Hz bis 6,3 kHz überschreitet der Klirrfaktor nicht 0,05% oder 0,1% im übrigen Teil des Bereiches. Die Frequenzgenauigkeit und Konstanz sind hoch. Die Ausgangsspannung lässt sich über einen Bereich von 100:1 einstellen.

Seite 28

MITTELFREQUENZOSZILLATOR TF 2101

Der Mittelfrequenzoszillator TF 2101 besitzt einen unsymmetrischen 600 Ohm Ausgang für Frequenzen von 30 Hz bis 550 kHz in 5 sich überschneidenden Teilbereichen. Die Ausgangsspannung lässt sich bei einem geringen Klirrfaktor bis 2 mW stetig regeln. Der Frequenzgang liegt innerhalb von 5% ist aber im grössten Teil des Bereiches besser als 1%. Das Gerät ist transistorisiert und kann sowohl am Netz als auch mit einer Batterie betrieben werden. Es hat viele Anwendungsmöglichkeiten auf dem Gebiet der Prüfung von Übertragungseinrichtungen.

Seite 34

DREI TONFREQUENZ- UND MITTELFREQUENZ-EICHLUITUNGEN

Die mit einer Pegelanzeige versehenen Tonfrequenz- und Mittelfrequenz-Eichleitungen TF 2160 und TF 2161 besitzen einen Wellenwiderstand von 600 Ohm und beide haben je 111 dB Dämpfung in Stufen von 10, 1 und 0,1 dB über einen Bereich von 0 bis 550 kHz. Der eingebaute Spannungsmesser besitzt Bereiche von 1,5, 5, 15 und 25 V und ausserdem eine Einteilung in dB in Bezug auf 0 dBm. Die Eichleitung TF 2160 hat ferner symmetrische Ausgänge von 600, 150 und 75 Ohm für den Frequenzbereich 20 Hz bis 20 kHz und die Ausführung TF 2161 hat einen unsymmetrischen Ausgang von 75 Ohm für einen geringeren Pegel. Die Mittelfrequenz-Eichleitung TF 2162 hat eine bessere Frequenzcharakteristik von 0 bis 1 MHz und einen Wellenwiderstand von 600 Ohm. Sie hat den gleichen Dämpfungsbereich und die gleichen

Stufen, jedoch nur einen unsymmetrischen Ausgang und der Spannungsmesser ist fortgelassen. Alle oben angegebenen Eichleitungen sind mit 1 Watt belastbar.

Seite 36

TONFREQUENZ- UND MITTELFREQUENZMESSENDER TF 2000 UND TF 2001

Der Tonfrequenz-Messender TF 2000 hat einen maximalen Ausgangspegel von +15 dBm im Bereich von 20 Hz bis 20 kHz und besitzt symmetrische und unsymmetrische Ausgänge für 75, 150 oder 600 Ohm. Im grössten Teil des Bereiches übersteigt der Klirrfaktor 0,1% nicht. Bei unsymmetrischen 600 Ohm Abschlüssen ist die entsprechende Zahl 0,05%. Ein Dämpfungsbereich von 111 dB in Stufen von 0,1 dB steht zur Verfügung. An die Eichleitung und den Spannungsmesser können Spannungen von 25 V (1 W) angelegt werden. Der Mittelfrequenz-Messender TF 2001 besitzt die gleiche Eichleitung und den gleichen Spannungsmesser und liefert einen maximalen Ausgangspegel von +3 dBm im Bereich von 30 Hz bis 550 kHz bei einem unsymmetrischen 600 Ohm Abschluss oder eine geringere Spannung bei einem 75 Ohm Abschluss. Bei einem Pegel von 0 dBm übersteigt der Klirrfaktor nicht 0,5%.

Seite 43

SCHEINWIDERSTANDSMESSUNGEN UND DIE MESSBRÜCKE TF 2701 ZUR MESSUNG AN VERDRAHTETEN SCHALTUNGSTEILEN

Zunächst werden die bei der Messung an scheinbar einfachen Schaltungsteilen, vor allem an Elektrolytkondensatoren auftretenden Probleme besprochen und der Vorteil von zwei zur Verfügung stehenden Messfrequenzen wird hervorgehoben.

Dann folgen Beispiele für Messungen an verdrahteten Schaltungsteilen, um die Vorteile dieser Messbrücke zu illustrieren. Abschliessend werden die mit der vorhergehenden Diskussion im Zusammenhang stehenden Vorteile des Gerätes TF 2701 beschrieben.

Seite 46

SOMMARIO DEGLI ARTICOLI PUBBLICATI IN QUESTO NUMERO

OSCILLATORE A BASSA FREQUENZA TF 2100

Questo piccolo oscillatore a bassa frequenza transistorizzato fornisce più di 8 V a circuito aperto, ovvero 4 V su un carico di 600 Ω adattato, nell'intervallo di frequenze da 20 Hz a 20 kHz. Il fattore di distorsione non supera 0,05% a frequenze comprese fra 63 Hz e 6,3 kHz, o 0,1% altrove. La precisione e la stabilità di frequenza sono elevate. La tensione di uscita può essere regolata convenientemente entro limiti di 100:1.

Pagina 28

OSCILLATORE A MEDIA FREQUENZA TF 2101

L'oscillatore a media frequenza TF 2101 fornisce un'uscita sbilanciata a 600 Ω a frequenze da 30 Hz a 550 kHz in cinque gamme parzialmente sovrapposte. Il livello di uscita è variabile con continuità fino ad un massimo di 2 mW con bassa distorsione. La risposta di frequenza è entro 5%, sebbene sulla maggior parte della gamma di frequenze sia in realtà migliore di 1%. Lo strumento è transistorizzato e può funzionare con alimentazione dalla rete o da pile ed ha molte applicazioni nel campo delle prove di apparecchiature di trasmissione.

Pagina 34

TRE ATTENUATORI PER BASSA E MEDIA FREQUENZA

Gli attenuatori con strumento di controllo TF 2160 per bassa frequenza e TF 2161 per media frequenza, hanno una impedenza caratteristica di 600 Ω , e forniscono entrambi un'attenuazione di 111 dB con scatti di 10, 1 e 0,1 dB da c.c. a 550 kHz. Il voltmetro interno ha portate di 1,5, 5, 15 e 25 V, ed è anche munito di una scala in dB con riferimento a 0 dBm. Il TF 2160 ha inoltre uscite bilanciate a 600, 150 e 75 Ω nell'intervallo di frequenze da 20 Hz a 20 kHz, ed il TF 2161 ha una uscita sbilanciata a 75 Ω a livello ridotto. L'attenuatore per media frequenza TF 2162 ha una risposta di frequenza migliore che va da c.c. ad 1 MHz ed una

impedenza caratteristica di 600 Ω ; fornisce gli stessi valori di attenuazione regolabili al medesimo modo, ma dispone soltanto di una uscita sbilanciata e non comprende un voltmetro. Tutti i suddetti attenuatori sono in grado di accettare segnali della potenza di 1 watt.

Pagina 36

SORGENTI DI SEGNALI A BASSA FREQUENZA ED A MEDIA FREQUENZA TF 2000 E TF 2001

La sorgente di segnali a bassa frequenza TF 2000 fornisce un livello massimo di +15 dBm da 20 Hz a 20 kHz su carichi bilanciati o sbilanciati di 75, 150 o 600 Ω con meno di 0,1% di distorsione sulla maggior parte della gamma di frequenze, e meno di 0,05% su carichi sbilanciati di 600 Ω . L'uscita può essere attenuata fino a 111 dB ad intervalli di 0,1 dB, e l'attenuatore ed il voltmetro possono accettare segnali esterni fino a 25 V (1 watt). La sorgente di segnali a media frequenza TF 2001 comprende un attenuatore ed un voltmetro identici, e fornisce un livello massimo di +3 dBm da 30 Hz a 550 kHz su carichi sbilanciati di 600 Ω , od un segnale ridotto su carichi di 75 Ω , con meno di 0,5% di distorsione a 0 dBm.

Pagina 43

MISURE DI IMPEDENZA ED IL PONTE PER MISURE SU COMPONENTI IN SITO TIPO TF 2701

In primo luogo sono discussi problemi che si presentano nella misura di componenti apparentemente semplici, particolarmente condensatori elettrolitici, e si indicano i vantaggi derivanti dalla disponibilità di due frequenze per le misure.

Vengono poi dati esempi di misure in loco che fanno risaltare i vantaggi di un ponte speciale per tali misure. Per concludere si descrivono le particolarità funzionali speciali del TF 2701 attinenti alla precedente discussione.

Pagina 46

RESUMENES DE ARTICULOS QUE APARECEN EN ESTE NUMERO

OSCILADOR DE AF TF 2100

Este pequeño oscilador de AF es transistorizado y provee más de 8 voltios sin carga o 4 voltios a una carga de 600 ohmios sobre el margen de frecuencias desde 20 Hz hasta 20 kHz.

El factor de deformación no es más del 0,05% desde 63 Hz hasta 6,3 kHz o el 0,1% en otras frecuencias y la exactitud y estabilidad de frecuencia es muy buena.

La tensión de la salida puede ser ajustada convenientemente sobre la gama de 100:1.

Página 26

OSCILADOR DE FM TF 2101

El oscilador de frecuencias medias tipo TF 2101 tiene una salida de 600 ohmios, desequilibrada con un margen de frecuencias desde 30 Hz hasta 550 Hz en 5 gamas que traslapan.

El nivel de salida es continuamente variable hasta 2 mW con poca deformación. La respuesta de frecuencia está dentro del 5%, pero sobre casi todo el margen es mejor del 1%. El instrumento es transistorizado y puede ser operado con batería o por la red y puede tener muchas aplicaciones en el campo de pruebas de equipo de transmisión.

Página 34

TRES ATENUADORES AF/FM

Los atenuadores de pruebas en a.f. y f.m. tipos TF 2160 y TF 2161 tienen una impedancia característica de 600 ohmios y ambos proveen 111 dB de atenuación en pasos de 10, 1 y 0,1 dB desde C.C. hasta 550 kHz.

El voltímetro interno tiene gamas de 1,5, 5, 15 y 25 voltios y también está escalado en dB con respecto a 0 dBm. El TF 2160 tiene adicionales salidas equilibradas de 600, 150 y 75 ohmios en la gama de frecuencias de 20 Hz hasta 20 kHz y el TF 2161 tiene una salida desequilibrada de 75 ohmios a un nivel reducido.

El atenuador de M.F. tipo TF 2162 tiene una respuesta de frecuencia superior desde C.C. hasta 1 MHz y una impedancia característica de 600 ohmios.

Provee la misma gama de atenuación y ajustes, pero la salida es solamente desequilibrada y las facilidades del voltímetro no se incluyen. Todos estos atenuadores son capaces de manejar 1 W.

Página 36

FUENTE DE SENALES EN AF Y FM TF 2000 Y TF 2001

La fuente de señales en AF tipo TF 2000 provee un nivel mínimo de +15 dBm desde 15 Hz hasta 20 kHz en cargas equilibradas o desequilibradas de 75, 50 y 600 ohmios con una deformación de onda que es de menos del 0,1% o 0,05% en cargas de 600 ohmios desequilibradas. La gama de atenuación de 111 dB se provee en pasos de 0,1 dB y el atenuador y el voltímetro pueden aceptar señales externas hasta 25 voltios (1 W).

La fuente de señales en FM tipo TF 2001 tiene el mismo atenuador y medidor y provee un nivel máximo de +3 dBm desde 30 Hz hasta 550 kHz en cargas de 600 ohmios desequilibradas o una señal reducida en una carga de 75 ohmios con deformación de menos del 0,5% en 0 dBm.

Página 43

MEDICIONES DE IMPEDANCIA Y EL PUENTE TF 2701 PARA MEDIDAS IN SITU

Se discuten los problemas que están asociados con las mediciones de lo que aparecen ser componentes simples particularmente condensadores electrolíticos y las ventajas que se pueden tener con dos frecuencias para la medición.

Se dan ejemplos de mediciones en posición con el fin de que se pueda apreciar las ventajas de esta clase de puente y se concluye con una discusión de los particulares distintivos del TF 2701.

Página 46

MARCONI INSTRUMENTS
111 Cedar Lane
Englewood, N.J.

BULK RATE
U.S. POSTAGE

PAID

Englewood, N.J.
Permit No. 313

SIGNAL GENERATORS

NOISE GENERATORS

OSCILLATORS

OSCILLOSCOPES

PULSE GENERATORS

MODULATION METERS

DISTORTION ANALYSERS

SPECTRUM ANALYSERS

FREQUENCY COUNTERS
AND METERS

POWER METERS

VOLTMETERS

IMPEDANCE BRIDGES,
DIELECTRIC AND Q METERS

MOISTURE METERS

pH METERS

IMAGE AMPLIFIERS FOR
INDUSTRIAL AND MEDICAL
X-RAY EQUIPMENT

ATOMIC POWER
INSTRUMENTATION

Mr. A. Browdy, C. E.
KCOP-TV
1962 So. Stearns Dr.
Los Angeles 34, Calif.

Return Requested

MARCONI INSTRUMENTS LIMITED

SALES AND SERVICE OFFICES

London and the South

ENGLISH ELECTRIC HOUSE, STRAND, LONDON, W.C.2
Telephone: Covent Garden 1234 Telex: 22572

Midland (East)

ST. ALBANS, HERTFORDSHIRE
Telephone: St. Albans 59292 Telex: 23350

Midland (West)

40 WHITELADIES ROAD, BRISTOL, 8
Telephone: Bristol 39639

Northern

23/25 STATION SQUARE, HARROGATE
Telephone: Harrogate 67454 (2 lines) Telex: 5723

Service Division

HEDLEA WORKS, HEDLEY ROAD, ST. ALBANS
Telephone: St. Albans 50731 (4 lines) Ansafone

U.S.A.

111 CEDAR LANE, ENGLEWOOD, NEW JERSEY
Telephone: LOwell 7-0607

Head Office and Works

ST. ALBANS **HERTFORDSHIRE** **ENGLAND**
Telephone: St. Albans 59292 Telex: 23350 Telegrams: Measurtest, St. Albans, Telex

ASSOCIATED COMPANIES AND DISTRIBUTORS THROUGHOUT THE WORLD

*Printed in England by
The Campfield Press
St. Albans*