

4 THESE CONTACTS ARE SHORTED TO GROUND WHEN NOT SELECTED

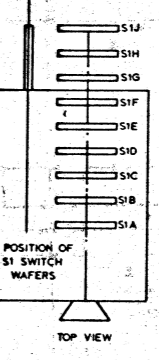

DC VOLTAGES MEASURED ON AVO 8 10V DC RANGE

NB. NO. OF COMPONENTS OUTSIDE IDENTIFIED MODULES ARE PREFIXED 8

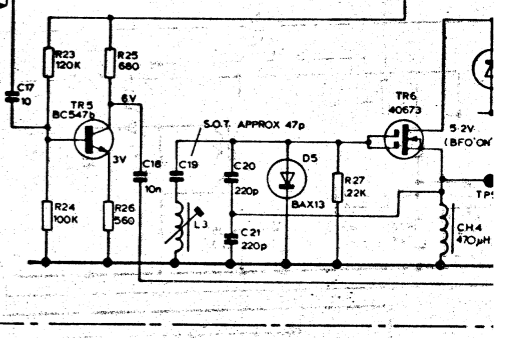
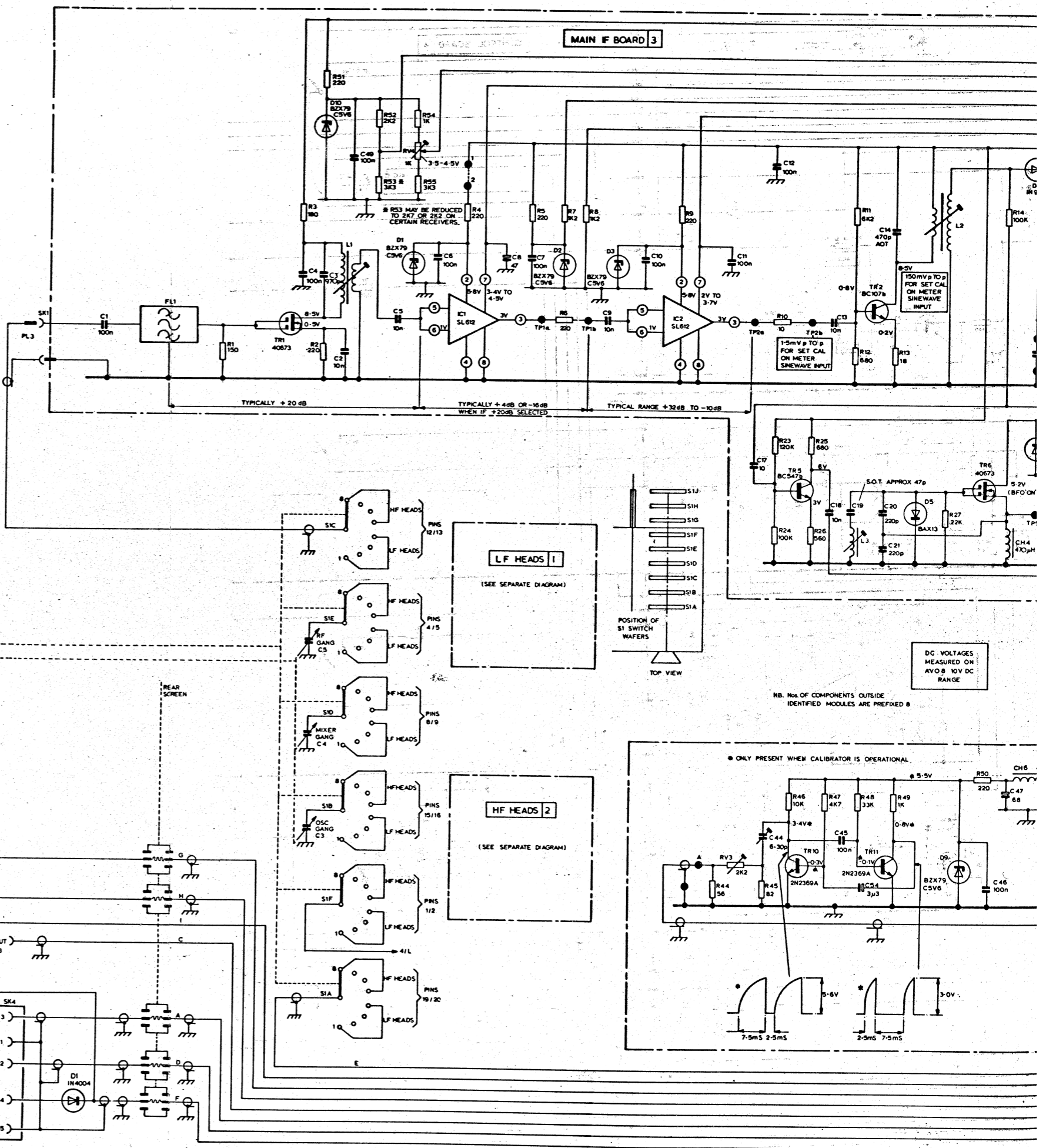
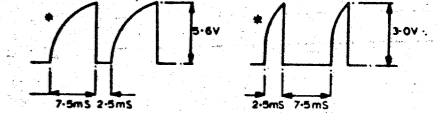
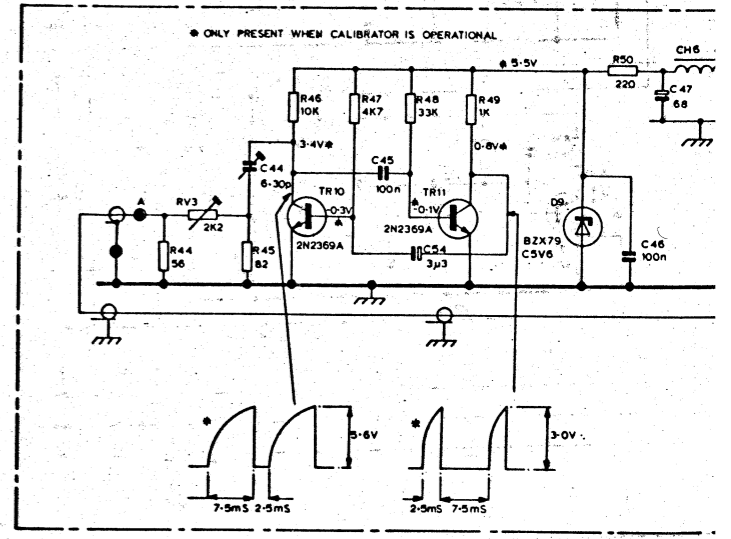

MAIN F BOARD 3

CONTROL BOARD 4

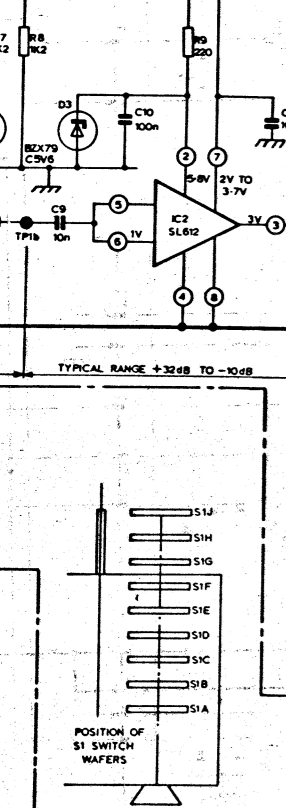
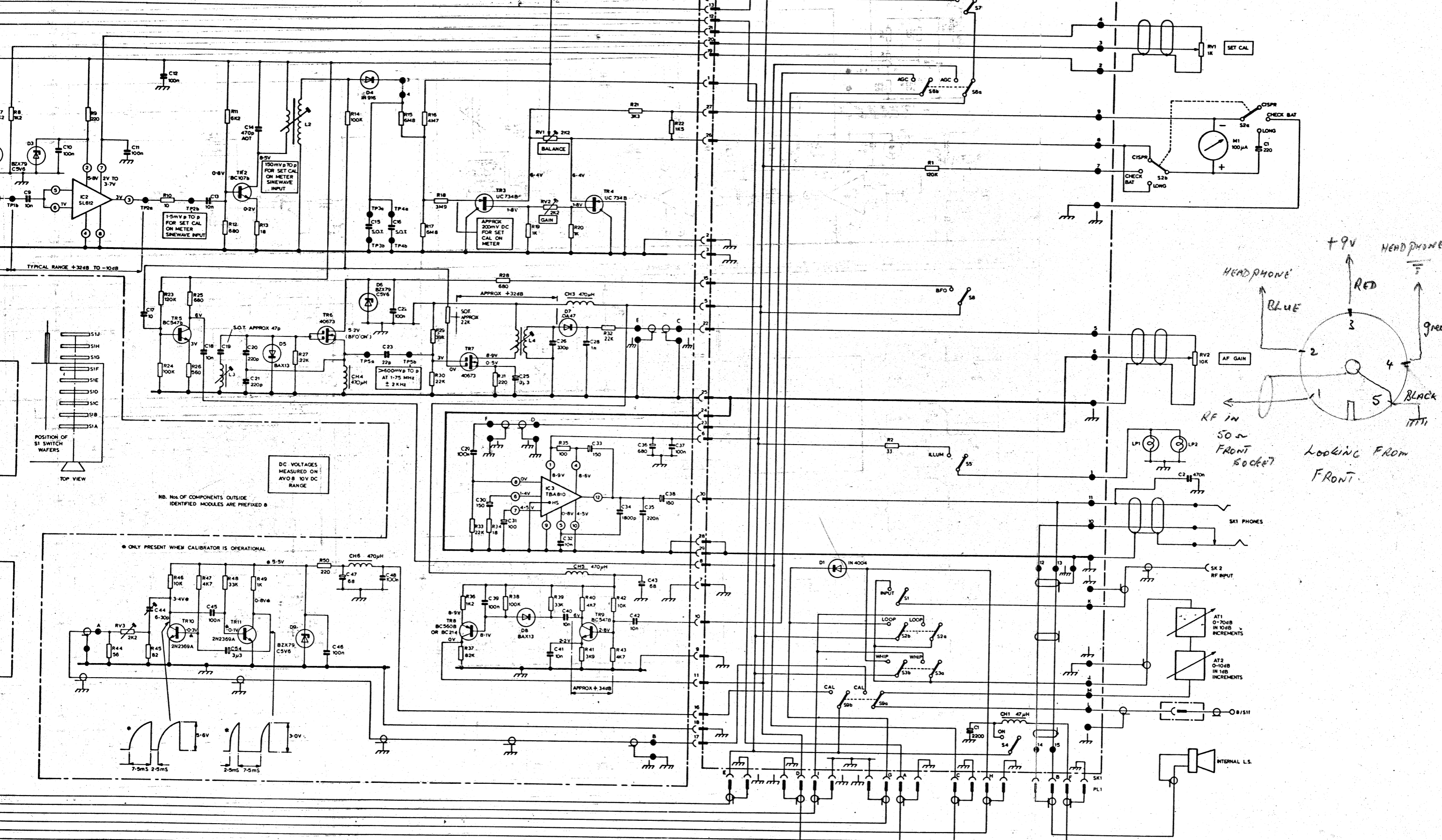

DC VOLTAGES MEASURED ON AVO B 10V DC RANGE

NB. No. of COMPONENTS OUTSIDE IDENTIFIED MODULES ARE PREFIXED 0

ONLY PRESENT WHEN CALIBRATOR IS OPERATIONAL

